

Safety Light Curtains

F3SJ-A



Rev. 2.12

Safety Light Curtains

- Resolution: 14 mm (0.55 in.), 20 mm (0.79 in.), 25 mm (1.01 in.), 30 mm (1.18 in.), or 55 mm (2.17 in.)
- Range: 7 m (23 ft.) or 9 m (29.5 ft.) dependent on minimum object resolution and protected height
- Protected heights: 14 mm protected heights from 245 to 1631 mm (9.6 to 64 in.), 20 mm, 25 mm and 30 mm protected heights from 245 to 2495 mm (9.6 to 98 in.), 55 mm from 270 to 2470 mm (10.6 to 97 in.)
- Very compact size – 30 x 24 mm (1.18 x 0.94 in.)
- Cascaded designs possible – 4 segments, up to 400 beams
- Partial muting and position detection muting
- Cross-talk prevention

D



Description

Position Detection Muting Function

Position Detection Muting Function is used in applications where the workpiece is set in position each time by an operator, and a turntable or positioning robot then moves the workpiece to the area where the work is performed. A limit switch or other means is used to detect when the robot is in a safe position and muting is then applied.



Warning Zone Function

With the F3SJ-A, part of the detection zone can be used as warning zone to generate an alarm when someone approaches the danger zone. If the person then enters the danger zone the F3SJ-A will send a stop signal to the guarded machine. In addition, the auxiliary output can be used to activate a flashing lamp to alert the person in the warning zone.

The detection zone for a single F3SJ-A can be divided into two zones or set a single warning zone for multiple, cascaded F3SJ-A units.

Dividing the zone between series-connected sensors

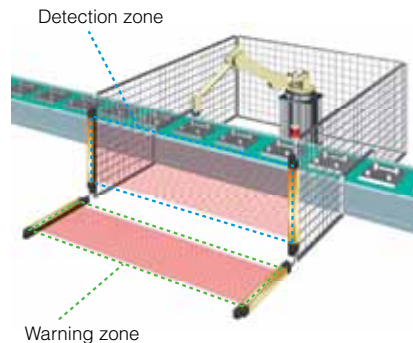

Partial Muting Function

Muting temporarily disables the F3SJ-A when an object must pass through the detection zone, such as when supplying a workpiece to your equipment.

Partial muting increases the level of safety by only muting the beams of the safety light curtain where the workpiece passes through, while preventing muting in all other areas.

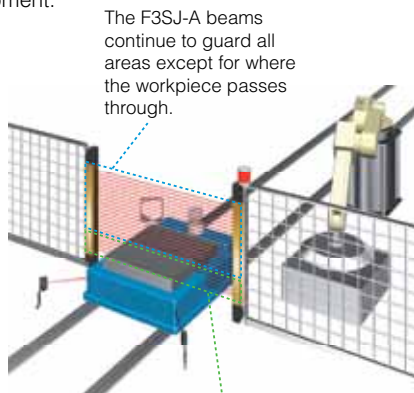

The F3SJ-A beams continue to guard all areas except for where the workpiece passes through.

Only the beams of the safety light curtain interrupted by the workpiece are muted.

SD Manager Software

Using the SD Manager software, all features of the F3SJ-A can be set and checked. Features include:

- Display of system specifications:
 - Model
 - Number of beams
 - Minimum object resolution
 - Response time
- Settings for:
 - Fixed blanking
 - Floating blanking
 - Warning zone configuration
 - Muting – Both partial and position detection
 - External indicator function
 - Auxiliary outputs
 - EDM parameters
 - Operating range
- Monitoring of received and ambient light intensity
- Maintenance information:
 - Power on time
 - OSSD switching frequency
- Recovery of settings
- Safety distance calculations based on parameters for connected system

Setting Console

When you don't want to take a computer into the field with you the F39-MC21 setting console is a convenient way to set parameters and check the system status.

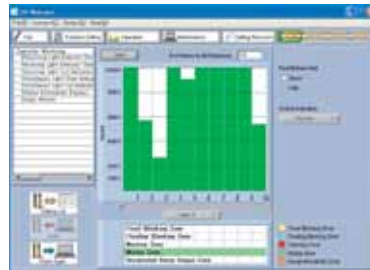
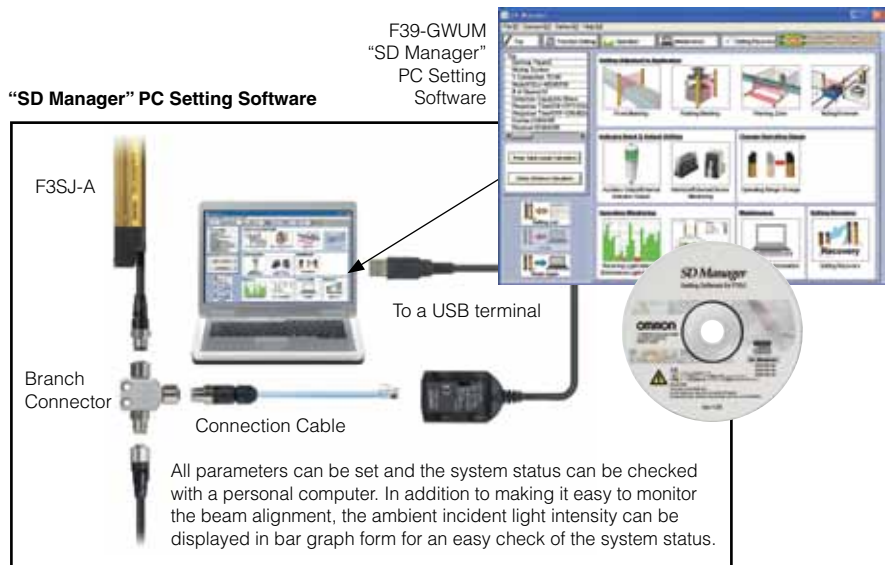

Beam Alignment is Easier

The incident light level can be displayed in a bar graph for each beam.

Applications

With built-in muting and blanking functions, the F3SJ-A can be employed in a wide variety of applications from robotic work cells to small machines. The potential for cascaded design and a broad selection of minimum object resolutions adds to this versatility.

Selecting the Best Configuration

Space Efficient and Low Cost

The built-in external device monitoring function eliminates the need for a safety relay unit.

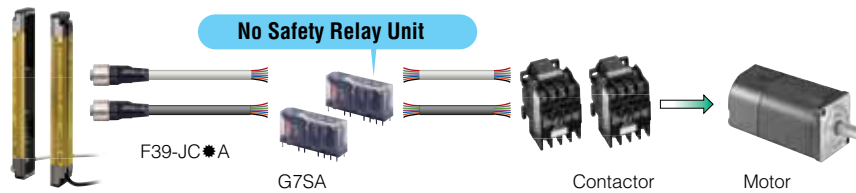

Reduced Wiring and Easy Maintenance

Cables with connectors on both ends simplify connections and prevent wiring errors.



Specifications

Performance	
Resolution:	14 mm, 20 mm, 25 mm, 30 mm, 55 mm
Protected Height:	14 mm – 245 to 1631 mm (9.6 to 64.2 in.) 20 mm, 25 mm and 30 mm – 245 to 2495 mm (9.6 to 98.2 in.) 55 mm – 270 to 2470 mm (10.6 to 97.2 in.)
Operating Range:	0.2 to 9 m for all protective heights up to 1640 mm (64.6 in.) 0.2 to 7 m for all protective heights longer than 1640 mm (64.6 in.):
Effective Aperture Angle:	±2.5° maximum, transmitter and receiver at operating range greater than 3 m (9.8 ft.)
Response Time:	For 14 mm resolution systems up to 983 mm (38.7 in.) protected height ≤17.5 ms For 14 mm resolution systems above 983 mm (38.7 in.) protected height ≤25 ms For 20 mm resolution systems up to 1205 mm (47.4 in.) protected height ≤15 ms For 20 mm resolution systems above 1205 mm (47.4 in.) protected height ≤22.5ms For 25 mm resolution systems up to 1600 mm (63.0 in.) protected height ≤15 ms For 25 mm resolution systems above 1600 mm (63.0 in.) protected height ≤20.0ms For 30 mm resolution systems, all protected heights ≤17.5 ms For 55 mm resolution systems, all protected heights ≤13 ms
Safety Output Rating:	Two 24 VDC PNP outputs sourcing 300 mA max.
Auxiliary (Non-Safety) Output Ratings:	One 24 VDC PNP output sourcing 300 mA max.
Light Source:	Infrared LED, 870 nm
Indicators:	Transmitter: 5 LED Light Level Indicators, 3 LED Error Indicators, Power, Interlock, EDM, Blanking/Test Receiver: 5 LED Light Level Indicators, 3 LED Error Indicators, Machine Run, Machine Stop
Mechanical	
Enclosure:	Anodized aluminum housing
Cable Length:	Optional cables are available up to 20 m (65.6 ft.) in length
Transmitter and Receiver Cable Connections:	M12, 8-pin
Electrical	
Power Supply:	24 VDC ± 20%
Environmental	
Protection Rating:	IP65
Operating Temperature:	-10 to 55°C (14 to 131°F)
Storage Temperature:	-30 to 70°C (-22 to 158°F)
Relative Humidity:	35 to 85% non-condensing
Vibration:	10 to 55 Hz, double amplitude of 0.7 mm, 20 sweeps in X, Y, and Z directions
Shock:	100 m/s ² , 1000 times each in X, Y and Z directions
Approvals	ESPE Type 4 (IEC 61496-1/-2) Category 4 / PL e (EN ISO 13849-1) SIL3 / SIL3 CL3 (IEC 61508)UL508, UL1998, CAN/CSA-C22.2 No. 14, CAN/CSA-C22.2 No. 0.8

Specifications are subject to change without notice.

F3SP-B1P Control Unit

Power Supply Voltage:	24 VDC ±10%
Power Consumption:	DC1.7 W max (not including sensor's current consumption)
Operation Time:	100 ms max. (not including the sensor's response time)
Response Time:	10 ms max. (not including the sensor's response time)
Relay Output	
Number of Contacts:	3 N.O., 1 N.C.
Rated Load:	250 VAC 5 A (cos = 1); 30 VDC 5 A L/R = 0 ms
Rated Current:	5 A
Connection Type	
Between Sensors:	M12 connector (8-pin)
Others:	Terminal block
Weight:	Approx. 280 g (9.9 oz.)

Specifications are subject to change without notice.

D

Wiring

Wiring for Single F3SJ-A Application

Detection of a welded relay contact is possible without a controller relay unit.

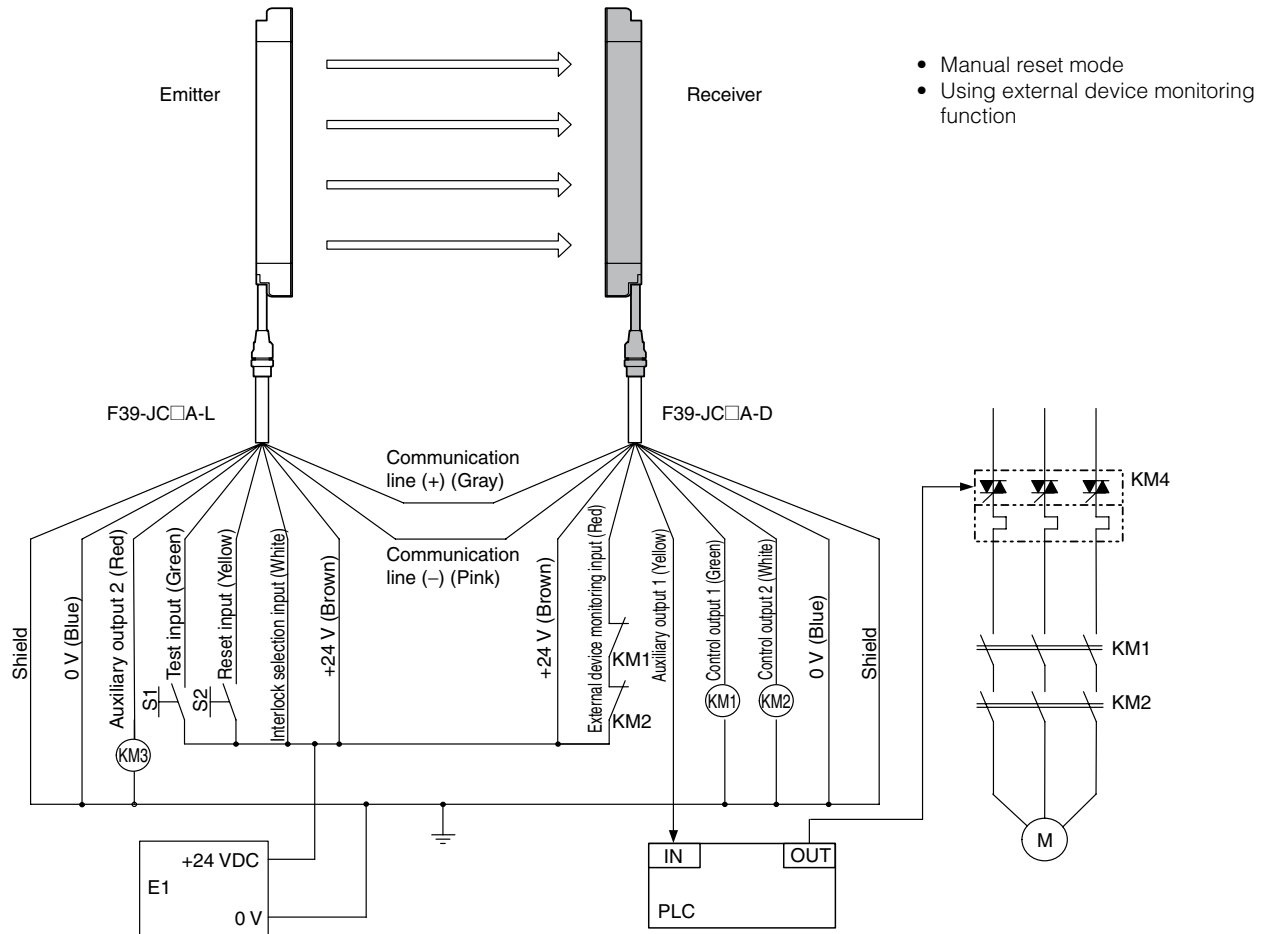

D

Ordering

The minimum components required for an F3SJ-A system are an emitter receiver set and a set of single or double-ended connector cables. See the table below for an overview of the versions available. The pages which follow provide specific part numbers and accessory descriptions.

Safety Light Curtain F3SJ-A

Designator	Protection	Detection	Beam Gap	Operating Range	No. of Beams	Protective Height
F3SJ-A□□□□P14 ¹	Finger	14 mm	9 mm	0.2 to 9 m (0.7 to 29.5 ft.)	26 to 197	245 to 1784 mm (9.6 to 70.2 in.)
F3SJ-A□□□□P20 ¹	Finger/Hand	20 mm	15 mm	0.2 to 9 m (0.7 to 29.5 ft.)	16 to 100	245 to 1505 mm (9.6 to 59.3 in.)
F3SJ-A□□□□P20 ¹	Finger/Hand	20 mm	15 mm	0.2 to 7 m (0.7 to 23.0 ft.)	110 to 166	1655 to 2495 mm (65.2 to 98.2 in.)
F3SJ-A□□□□P20-TS ²	Finger/Hand	20 mm	15 mm	0.2 to 9 m (0.7 to 29.5 ft.)	16 to 100	245 to 1505 mm (9.6 to 59.3 in.)
F3SJ-A□□□□P20-TS ²	Finger/Hand	20 mm	15 mm	0.2 to 7 m (0.7 to 23.0 ft.)	110 to 166	1655 to 2495 mm (65.2 to 98.2 in.)
F3SJ-A□□□□P25 ¹	Hand	25 mm	20 mm	0.2 to 9 m (0.7 to 29.5 ft.)	13 to 79	260 to 1580 mm (10.2 to 62.2 in.)
F3SJ-A□□□□P25 ¹	Hand	25 mm	20 mm	0.2 to 7 m (0.7 to 23.0 ft.)	87 to 125	1740 to 2500 mm (68.5 to 98.4 in.)
F3SJ-A□□□□P25-TS ²	Hand	25 mm	20 mm	0.2 to 9 m (0.7 to 29.5 ft.)	13 to 79	260 to 1580 mm (10.2 to 62.2 in.)
F3SJ-A□□□□P25-TS ²	Hand	25 mm	20 mm	0.2 to 7 m (0.7 to 23.0 ft.)	87 to 125	1740 to 2500 mm (68.5 to 98.4 in.)
F3SJ-A□□□□P30 ¹	Hand/arm	30 mm	25 mm	0.2 to 9 m (0.7 to 29.5 ft.)	10 to 65	245 to 1620 mm (9.6 to 63.8 in.)
F3SJ-A□□□□P30 ¹	Hand/arm	30 mm	25 mm	0.2 to 7 m (0.7 to 23.0 ft.)	70 to 100	1745 to 2495 mm (68.7 to 98.2 in.)
F3SJ-A□□□□P55 ¹	Leg/body	55 mm	50 mm	0.2 to 9 m (0.7 to 29.5 ft.)	6 to 33	270 to 1620 mm (10.6 to 63.8 in.)
F3SJ-A□□□□P55 ¹	Leg/body	55 mm	50 mm	0.2 to 7 m (0.7 to 23.0 ft.)	36 to 50	1770 to 2470 mm (69.7 to 97.2 in.)

Notes: Connection cables are not included with the products and must be purchased separately as needed.

Specific Model Numbers

Model	No. of Beams	Protective Height (mm)	Model	No. of Beams	Protective Height (mm)	Model	No. of Beams	Protective Height (mm)	Model	No. of Beams	Protective Height (mm)
F3SJ-A14 Series			F3SJ-A0635P20	42	635	F3SJ-A1180P25	59	1180	F3SJ-A1195P30	48	1195
F3SJ-A0245P14	26	245	F3SJ-A0665P20	44	665	F3SJ-A1260P25	63	1260	F3SJ-A1220P30	49	1220
F3SJ-A0263P14	28	263	F3SJ-A0695P20	46	695	F3SJ-A1420P25	71	1420	F3SJ-A1270P30	51	1270
F3SJ-A0299P14	32	299	F3SJ-A0755P20	50	755	F3SJ-A1500P25	75	1500	F3SJ-A1395P30	56	1395
F3SJ-A0317P14	34	317	F3SJ-A0785P20	52	785	F3SJ-A1580P25	79	1580	F3SJ-A1495P30	60	1495
F3SJ-A0389P14	42	389	F3SJ-A0815P20	54	815	F3SJ-A1740P25	87	1740	F3SJ-A1620P30	65	1620
F3SJ-A0425P14	46	425	F3SJ-A0875P20	58	875	F3SJ-A1900P25	95	1900	F3SJ-A1745P30	70	1745
F3SJ-A0461P14	50	461	F3SJ-A0905P20	60	905	F3SJ-A2060P25	103	2060	F3SJ-A1820P30	73	1820
F3SJ-A0533P14	58	533	F3SJ-A0935P20	62	935	F3SJ-A2220P25	111	2220	F3SJ-A1870P30	75	1870
F3SJ-A0551P14	60	551	F3SJ-A0965P20	64	965	F3SJ-A2380P25	119	2380	F3SJ-A1995P30	80	1995
F3SJ-A0605P14	66	605	F3SJ-A1025P20	68	1025	F3SJ-A2420P25	121	2420	F3SJ-A2245P30	90	2245
F3SJ-A0623P14	68	623	F3SJ-A1115P20	74	1115	F3SJ-A2500P25	125	2500	F3SJ-A2370P30	95	2370
F3SJ-A0695P14	76	695	F3SJ-A1205P20	80	1205	F3SJ-A30 Series			F3SJ-A2495P30	100	2495
F3SJ-A0731P14	80	731	F3SJ-A1265P20	84	1265	F3SJ-A0245P30	10	245	F3SJ-A55 Series		
F3SJ-A0767P14	84	767	F3SJ-A1445P20	96	1445	F3SJ-A0295P30	12	295	F3SJ-A0270P55	6	270
F3SJ-A0803P14	88	803	F3SJ-A1505P20	100	1505	F3SJ-A0320P30	13	320	F3SJ-A0320P55	7	320
F3SJ-A0875P14	96	875	F3SJ-A1655P20	110	1655	F3SJ-A0395P30	16	395	F3SJ-A0370P55	8	370
F3SJ-A0911P14	100	911	F3SJ-A1805P20	120	1805	F3SJ-A0470P30	19	470	F3SJ-A0420P55	9	420
F3SJ-A0983P14	108	983	F3SJ-A1955P20	130	1955	F3SJ-A0520P30	21	520	F3SJ-A0470P55	10	470
F3SJ-A1055P14	116	1055	F3SJ-A2105P20	140	2105	F3SJ-A0545P30	22	545	F3SJ-A0570P55	12	570
F3SJ-A1127P14	124	1127	F3SJ-A2255P20	150	2255	F3SJ-A0570P30	23	570	F3SJ-A0620P55	13	620
F3SJ-A1199P14	132	1199	F3SJ-A2405P20	160	2405	F3SJ-A0620P30	25	620	F3SJ-A0720P55	15	720
F3SJ-A1271P14	140	1271	F3SJ-A2495P20	166	2495	F3SJ-A0695P30	28	695	F3SJ-A0770P55	16	770
F3SJ-A1487P14	164	1487	F3SJ-A25, F3SJ-A25-TS* Series			F3SJ-A0720P30	29	720	F3SJ-A0870P55	18	870
F3SJ-A1631P14	180	1631	F3SJ-A0260P25	13	260	F3SJ-A0770P30	31	770	F3SJ-A0920P55	19	920
F3SJ-A1784P14	197	1784	F3SJ-A0300P25	15	300	F3SJ-A0795P30	32	795	F3SJ-A0970P55	20	970
F3SJ-A20, F3SJ-A20-TS* Series			F3SJ-A0460P25	23	460	F3SJ-A0820P30	33	820	F3SJ-A1020P55	21	1020
F3SJ-A0245P20	16	245	F3SJ-A0540P25	27	540	F3SJ-A0870P30	35	870	F3SJ-A1120P55	23	1120
F3SJ-A0275P20	18	275	F3SJ-A0620P25	31	620	F3SJ-A0920P30	37	920	F3SJ-A1170P55	24	1170
F3SJ-A0305P20	20	305	F3SJ-A0700P25	35	700	F3SJ-A0945P30	38	945	F3SJ-A1220P55	25	1220
F3SJ-A0395P20	26	395	F3SJ-A0780P25	39	780	F3SJ-A0995P30	40	995	F3SJ-A1270P55	26	1270
F3SJ-A0455P20	30	455	F3SJ-A0860P25	43	860	F3SJ-A1020P30	41	1020	F3SJ-A1320P55	27	1320
F3SJ-A0545P20	36	545	F3SJ-A0940P25	47	940	F3SJ-A1045P30	42	1045	F3SJ-A1420P55	29	1420
F3SJ-A0575P20	38	575	F3SJ-A1020P25	51	1020	F3SJ-A1095P30	44	1095	F3SJ-A1570P55	32	1570
F3SJ-A0605P20	40	605	F3SJ-A1100P25	55	1100	F3SJ-A1120P30	45	1120			

(Continued on next page)

Notes: Connection cables are not included with the products and must be purchased separately as needed.

* The suffix "-TS" is attached to the model number of models with fixed auto reset.

¹ Models with S-mark certification have an "S" at the end of the model number. S-mark certification is for equipment sold in South Korea. Example: F3SJ-A0245P14-S.

² Models with fixed auto reset (-TS). Parameters cannot be set using the F39-MC21 Setting Console or F39-GWUM "SD Manager" Support Software for F3SJ-A.

 = Highlighted **Rapid Delivery** products are available for shipment today or within **THREE** days.

Ordering (continued)

Model	No. of Beams	Protective Height (mm)
F3SJ-A1620P55	33	1620
F3SJ-A1770P55	36	1770
F3SJ-A1920P55	39	1920
F3SJ-A2070P55	42	2070
F3SJ-A2220P55	45	2220
F3SJ-A2370P55	48	2370
F3SJ-A2470P55	50	2470



For information on Resource Modules, see page D59.



For information on safety light curtain accessories, see page D74.

Accessories

D

Model	Description
Single-End Connector Cable (2 cables per set, for emitter and receiver) For wiring with safety circuit such as single safety relay, safety relay unit, and safety controller	
F39-JC3A	M12 connector (8-pin), 3 m (9.8 ft.)
F39-JC7A	M12 connector (8-pin), 7 m (23.0 ft.)
F39-JC10A	M12 connector (8-pin), 10 m (32.8 ft.)
F39-JC15A	M12 connector (8-pin), 15 m (49.2 ft.)
F39-JC20A	M12 connector (8-pin), 20 m (65.6 ft.)
Double-End Connector Cable (2 cables per set, for emitter and receiver) For connection with F3SP-B1P control unit, and for extension when series-connected. Note: To extend the cable length under series connection, use F39-JJR3W and F39-JC□B in combination.	
F39-JCR5B	M12 connector (8-pin), 0.5 m (1.6 ft.)
F39-JC1B	M12 connector (8-pin), 1 m (3.3 ft.)
F39-JC3B	M12 connector (8-pin), 3 m (9.8 ft.)
F39-JC5B	M12 connector (8-pin), 5 m (16.4 ft.)
F39-JC7B	M12 connector (8-pin), 7 m (23.0 ft.)
F39-JC10B	M12 connector (8-pin), 10 m (32.8 ft.)
F39-JC15B	M12 connector (8-pin), 15 m (49.2 ft.)
F39-JC20B	M12 connector (8-pin), 20 m (65.6 ft.)
Series Connection Cable (2 cables per set, for emitter and receiver)	
F39-JJR3W	Series connection cable ³ or when using water-resistant case ⁴ , 0.3 m (1.0 ft.)
F39-JC□B	Extension cable, 0.5 to 15 m (1.6 to 49.2 ft.) To change series connection length in combination with F39-JJR3W
F39-JJR06L	Side-by-side series connection cable, 0.06 m (2.4 in.) Dedicated series connection cable with minimum length, used in place of the sensor's cable with connector
F39-JJR15L	Side-by-side series connection cable, 0.15 m (5.9 in.) Dedicated series connection cable with minimum length, used in place of the sensor's cable with connector
Sensor Mounting Brackets (spare parts)	
F39-LJ1	Standard mounting bracket (for top/bottom), included with F3SJ system, 2 for emitter and 2 for receiver (total of 4 per set)
F39-LJ2	Flat side mounting bracket, Use these small-sized brackets when performing side mounting with standard mounting brackets so that they do not protrude from the detection surface, 2 for emitter and 2 for receiver (total of 4 per set)
F39-LJ3	Free-location mounting bracket (also used as standard intermediate bracket), Use these brackets for mounting any place without using standard bracket, 1 set with 2 pieces
Key Cap for Muting	
F39-CN6	Cap attaches to the main unit to enable muting function, attach to either an emitter or a receiver, orange case
Setting Tools⁵	
F39-GWUM	SD Manager Software Accessories: SD Manager CD-ROM, F39-CN1 Branch Connector, Connector Cap, 2 m Dedicated Cable, 0.3 m Dedicated Cable with Plug, Instruction Manual
F39-MC21	Setting Console Accessories: F39-CN1 Branch Connector, Connector Cap, 2 m Dedicated Cable, 0.3 m Dedicated Cable with Plug, Instruction Manual
F39-JC2M	Spare cable for F39-GWUM and F39-MC21



F39-JC7A



F39-JC15B



F39-JJR3W



F39-JJR06L
F39-JJR15L



F39-LJ1



F39-LJ2



F39-LJ3



F39-CN6

³ Total cable length of series connection is 0.6 m to connect to connector cable of the main sensor unit. For series connection with minimum length, use the F39-JJR06L or F39-JJR15L.

⁴ When using the F39-EJ□□□□-L/D water-resistant case in series connection configurations, use the special series connection cables for the water-resistant case.

(Continued on next page)

= Highlighted **Rapid Delivery** products are available for shipment today or within **THREE** days.

Ordering (continued)

Accessories (continued)

Model	Description
Setting Tools⁵	
F39-GWUM	SD Manager Software Accessories: SD Manager CD-ROM, F39-CN1 Branch Connector, Connector Cap, 2 m Dedicated Cable, 0.3 m Dedicated Cable with Plug, Instruction Manual
F39-MC21	Setting Console Accessories: F39-CN1 Branch Connector, Connector Cap, 2 m Dedicated Cable, 0.3 m Dedicated Cable with Plug, Instruction Manual
F39-JC2M	Spare cable for F39-GWUM and F39-MC21
Control Unit	
F3SP-B1P	Relay, 3 N.O. + 1 N.C. output, for connection with F3SJ-A, use an F39-JC□B double-end connector cable
Force-Guided Relays	
G7SA-2A2B	4 contacts, 2 N.O. + 2 N.C., Rated switch load: 250 VAC 6 A, 30 VDC 6 A
G7SA-3A1B	4 contacts, 3 N.O. + 1 N.C., Rated switch load: 250 VAC 6 A, 30 VDC 6 A
G7S-4A2B-E	6 contacts, 4 N.O. + 2 N.C., Rated switch load: 250 VAC 10 A, 30 VDC 10 A
G7S-3A3B-E	6 contacts, 3 N.O. + 3 N.O., Rated switch load: 250 VAC 10 A, 30 VDC 10 A
Dedicated External Indicator Set (Can be connected to either an emitter or a receiver)	
F39-A01PR-PAC	Indicator (red), mounting bracket (1 set), and dedicated connection cable (0.1 m)
F39-A01PG-PAC	Indicator (green), mounting bracket (1 set), and dedicated connection cable (0.1 m)
F39-A01PY-PAC	Indicator (yellow), mounting bracket (1 set), and dedicated connection cable (0.1 m)
General External Indicator Cable	
F39-JJ3N	Cable to connect top of the main unit and an off-the-shelf external indicator (2-wire), 3 m (9.8 ft.)
Spatter Protection Cover	
F39-HJ□□□□	For F3SJ-A series sensor, reduces operating range by 10%, includes two pieces for emitter and receiver
Water-Resistant Case (Set of 1 tube, packing, and dedicated connector cable) When using for both emitter and receiver, order two sets.	
F39-EJ□□□□-L	Water-resistant case for emitter, includes gray cable for emitter
F39-EJ□□□□-D	Water-resistant case for receiver, includes black cable for receiver
F39-EJ-R ⁶	Rear mounting brackets, top/bottom 1 each, total of 2
F39-EJ-S ⁶	Side mounting brackets, top/bottom 1 each, total of 2
F39-JJR3WE-L	Series connection cable for emitter, purchase additionally for series connection when using the water-resistant case
F39-JJR3WE-D	Series connection cable for receiver, purchase additionally for series connection when using the water-resistant case
Branch Connector for F3SX (F39-JC□T to F39-JC□B)	
F39-CN5	Branch connector for F3SX
Wire-Saving Devices	
F39-CN8	Short-circuit connector
F39-TC5P01	Connector terminal box with muting sensor output mode (PNP)
F39-TC5P02	Connector terminal box with override mode (PNP)
F39-TC5N01	Connector terminal box with muting sensor output mode (NPN)
F39-TC5N02	Connector terminal box with override mode (NPN)
F3SP-T01	Safety terminal relays for F3SJ-A_-P_
Laser Alignment Tool	
F39-PTJ	Laser alignment tool for the F3SJ

⁵ The setting tools described above can be connected only to F3SJ-A models with built-in software of Ver. 2 or later. Note that the setting tools cannot be used with products shipped prior to December 2005. The setting tools cannot be used for setting parameters on the F3SJ-A□-TS series, but the monitoring function can be used.

⁶ Be sure to purchase brackets with the case to match the mounting direction (rear or side).

 = Highlighted **Rapid Delivery** products are available for shipment today or within **THREE** days.

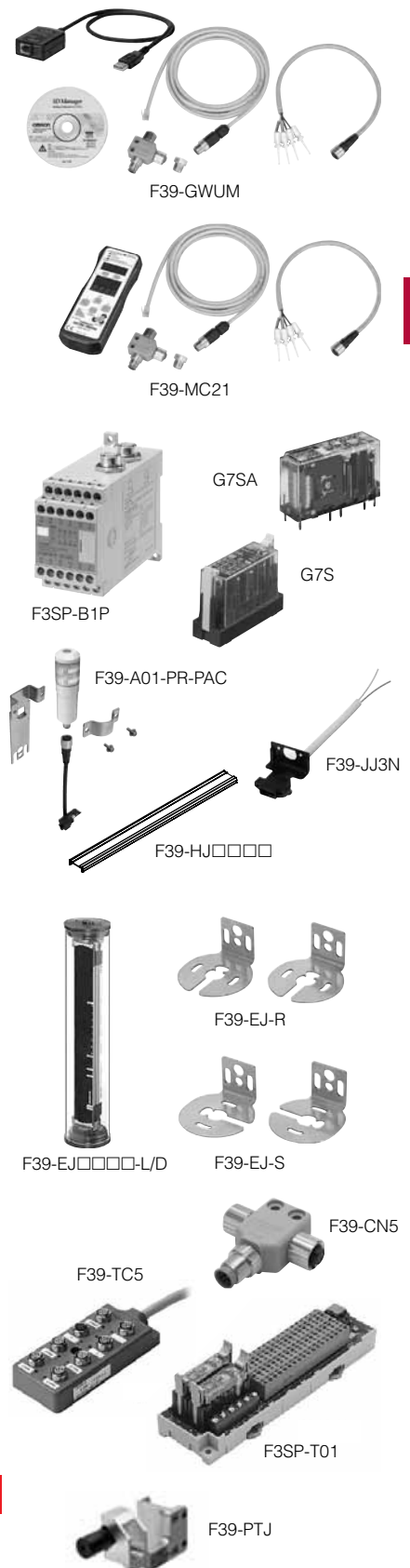

D