



## Rope Pull Emergency Stop Switch

- Rope spans up to 200 m (656 ft.) makes this switch ideal for applications where long rope spans are required
- IP67 (NEMA 6) enclosure enables the ER1032 switch to withstand water washdown cleaning
- Integral E-stop—the E-stop button provides emergency stopping capability at the extreme end of the installation and is field serviceable
- Tension indicator makes system setup and rop tension maintenance easy
- 4 N/C safety contacts and 2 N/O auxiliary contacts satisfy the most demanding applications
- Vibration tolerant—the snap-acting switch contacts protect against nuisance tripping due to vibration
- Indicator beacon—the indicator beacon, available in 24 VDC or 120 VAC can be wired to flash red to indicate a tripped switch or glow a constant green to indicate a properly reset switch
- Rubber bellows contain UV inhibitor making the switches suitable for outdoor applications



G



Conforms to IEC947-5-1, IEC947-5-5, EN418, UL508, BS5304  
UL and C-UL listed, TUV certified

## Specifications

Electrical	All Models
Contact Configurations:	4 N/C + 2 N/O
Safety Contacts:	4 N/C
Switching Ability	AC: 240 V-3 A, 120 V-6 A, Inductive: DC: 24 V-2.5 A, Inductive
Auxiliary Contacts:	2 N/O
Max Switching Current/Volt/Amp:	240 V/720 VA
Minimum Current:	5 V 5 mA DC
Electrical Life:	1 x 10 <sup>6</sup> minimum
LED Indicator Beacon	24 VDC or 120 VAC
Mechanical	
Mounting:	Any position
Mounting Hardware:	4 x M5 screws
Max Rope Span:	125 m (410 ft.)
Operation Force:	< 125 N (28 lb.)
Tensioning Force to Run Position:	130 N (23 lb.) typical
Case Material:	Die-cast aluminum alloy
Eye Nut Material:	Stainless steel
Wiring Entry:	4 x M20 or 4 x 0.5 in. NPT
Weight:	1320 g (42 oz.)
Color:	Yellow
Mechanical Life:	1 x 10 <sup>6</sup> minimum
Environmental	
Protection:	IP67 (NEMA 6)
Operating Temperature:	-25 to 80°C (-13 to 176°F)
Cleaning:	Water washdown
Compliance	
Standards:	IEC947-5-1, IEC947-5-5, EN418, UL508, BS5304
Approvals/Listings:	CE marked for all applicable directives, UL and C-UL, TUV

Specifications are subject to change without notice.

Note: The safety contacts of the Omron STI switches are described as normally closed (N/C)—i.e., with the rope properly tensioned and the machine able to be started.

## Operation



**Blue Reset Knob**  
A blue reset button is provided to easily return the unit back to its machine-run position after actuation.

### Installation Hardware Available

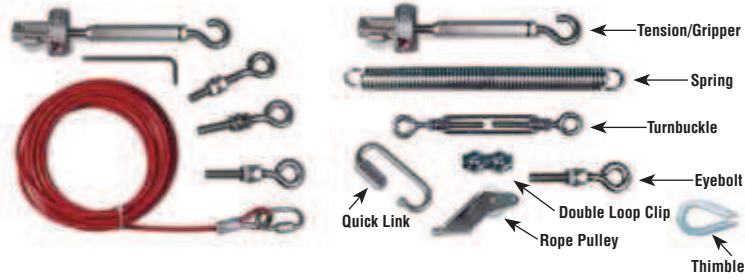

**RK Rope Tension Kit**  
The RK Rope Tension Kit comes with all of the required hardware for most installations. A spring is required as shown in the installation example below.

**Installation Hardware**  
Individual hardware items may be purchased for specific installation requirements.

### Contact Arrangements

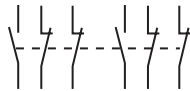

	0 mm 0 in	4.0 0.16	15.0 0.59	17.0 0.67
4NC + 2NO	Rope Slack	Tension Range		Rope Pulled
11/12				
21/22				
33/34				
41/42				
51/52				
63/64				

Contact Open     Contact Closed

G

### Mounting Specification

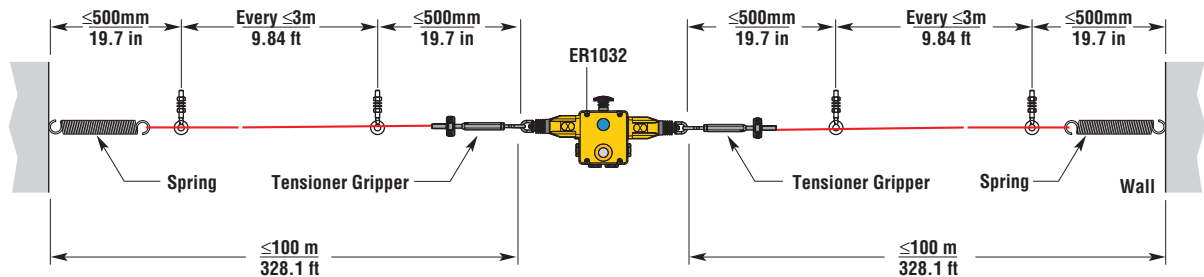
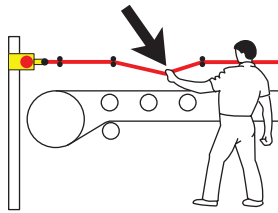

Note: Some installations may require a ER1022 on each end.



For a guide to installing, see "Proper Installation of Rope or Wire Pull Switches" in The Safety Library Section of this catalog on page A77.

Dimensions

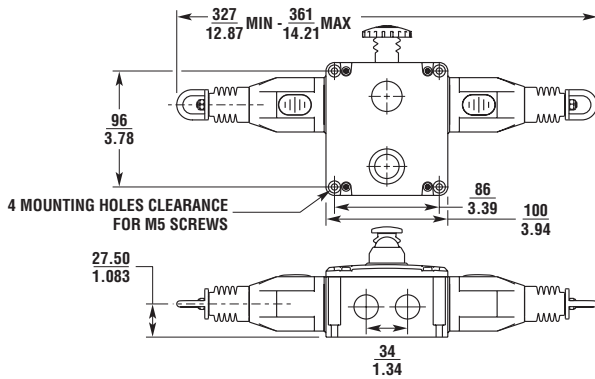

(mm/in.)

Applications

Typical applications are on conveyor systems and across rotating machinery, and around hazardous areas.

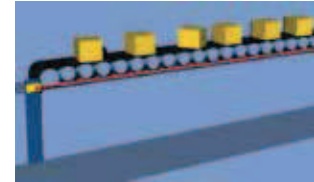
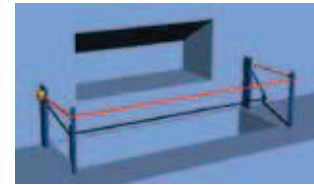

G

Ordering

Model	E-Stop	Indicator Beacon	Contacts	Wiring Entry	Part No.
ER1032-042MEL	Included	Included (24 VDC)	4 N/C + 2 N/O	4 x M20	44506-7410
ER1032-042MELAC	Included	Included (120 VAC)	4 N/C + 2 N/O	4 x M20	44506-7411
ER1032-042NEL	Included	Included (24 VDC)	4 N/C + 2 N/O	4 x 1/2 in. NPT	44506-7420
ER1032-042NELAC	Included	Included (120 VAC)	4 N/C + 2 N/O	4 x 1/2 in. NPT	44506-7421

Accessories	Part No.
SM06-SL711, Replacement Lid/LED, 24 VDC	44506-7710
SM06-SL711AC, Replacement Lid/LED, 120 VAC	44506-7711
RK5, 5 m Rope Kit, Stainless Steel	44506-2705
RK10, 10 m Rope Kit, Stainless Steel	44506-2710
RK15, 15 m Rope Kit, Stainless Steel	44506-2715
RK20, 20 m Rope Kit, Stainless Steel	44506-2720
RK30, 30 m Rope Kit, Stainless Steel	44506-2730
RK50, 50 m Rope Kit, Stainless Steel	44506-2750
RK80, 80 m Rope Kit, Stainless Steel	44506-2780
RK100, 100 m Rope Kit, Stainless Steel	44506-2711
RK126, 126 m Rope Kit, Stainless Steel	44505-2726
R5M, 5 m Rope Only	44506-3705
R10M, 10 m Rope Only	44506-3710
R20M, 20 m Rope Only	44506-3720
R30M, 30 m Rope Only	44506-3730
R50M, 50 m Rope Only	44506-3750
R80M, 80 m Rope Only	44506-3780
R100M, 100 m Rope Only	44506-3711
R126M, 126 m Rope Only	44506-3726

Accessories	Part No.
SM06-TK00, Tensioner Kit (Turnbuckle, 8 Rope Grips & 4 Thimbles)	44506-0700
SM06-TG00, Tensioner Gripper, Stainless Steel	44506-4700
SM06-EB10, Eye Bolt, Stainless Steel, 8 per pack	44506-4710
SM06-EB20, Eye Bolt, Galvanized	44506-0720
SM06-DL20, Double Loop Clip, Stainless Steel, 4 per pack	44506-4720
SM06-DL21, Double Loop Clip, Galvanized, 4 per pack	44506-4721
SM06-THSS, Thimble, Stainless Steel, 4 per pack	44506-4770
SM06-THGV, Thimble, Galvanized, 4 per pack	44506-4771
SM06-TB30, Turnbuckle, Stainless Steel	44506-4730
SM06-TB31, Turnbuckle, Galvanized	44506-4731
SM06-SP30, Spring, Galvanized	44506-0730
SM06-SP50, Spring, Stainless Steel	44506-4750
SM06-RPSS, Rope Pulley, Stainless Steel	44506-4780
SM06-ES60, E-Stop Mechanism	44506-4760
SM06-LF40, Replacement LED Indicator Beacon, 24 VDC	44506-4740
SM06-LF41, Replacement LED Indicator Beacon, 120 VAC	44506-4741

= Highlighted **Rapid Delivery** products are available for shipment today or within **FIVE** days.