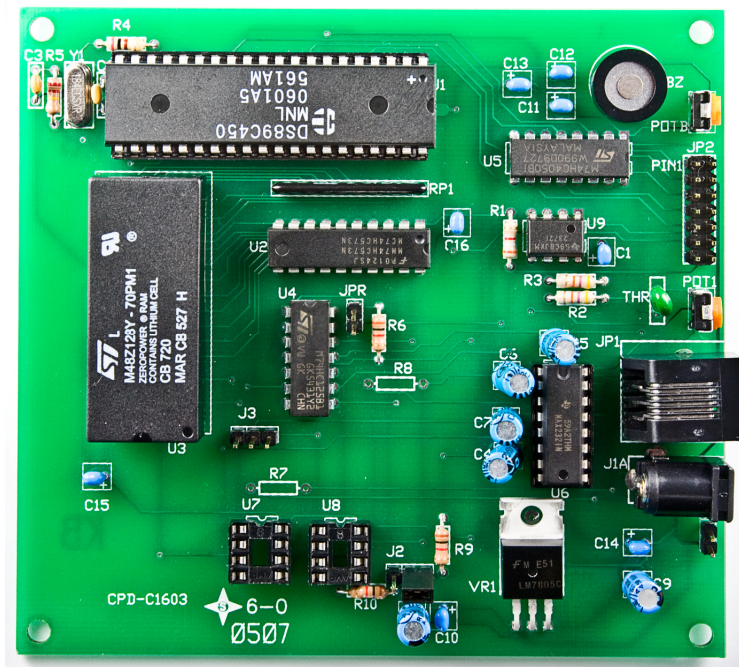

IS-C1603 Intelligent Controller Users Manual

Revision C

IS-C1603

16 Switch Controller Version 1.4

**NKK SWITCHES**7850 E. Gelding Drive
Scottsdale, AZ 85260

Toll Free 1-877-2BUYNKK (877-228-9655)

Phone 480-991-0942

Fax 480-998-1435

e-mail <engineering@nkkswitches.com>

All Rights Reserved Worldwide

NKK Switches makes no warranty for the use of these products and assumes no responsibility for any errors, which may appear in this document, nor does it make a commitment to update the information contained herein. Smart Switch is trademark of NKK Switches.

TABLE OF CONTENTS

Table of Contents2

1. General Controller Features3

2. Compatible Logic Boards.....4

3. Operational Detail.....5

4. Communication Protocol8

5. Hardware32

6. Key Terms & Definitions.....40

7. Programming the Firmware.....41

8. Firmware problems41

Appendix.....42

1. General Controller Features

The IS-C1603 controls 16 LCD 36x24 switches/ displays. The IS-C1603 is designed to be used in many different applications. There is total flexibility with user-defined features that allow the controllers to be programmed for specific applications. The user defined data and set up are stored in a non volatile memory and specify the way the system behaves. The firmware can be customized based on customer requirements. Below are current features:

General features:

- 16 LCD 36x24 switches/ displays
- Serial communication via RS232 (9.6K default, 19.2K, 57.6K, 1 start bit, 8 bit , 1 stop bit)
- RS422 optional
- Program responses to switch-actions events and timer-expire events.
- User programmable for images, attributes and set-ups.
- Set the type of activity reports from the controller to host.
- LED Brightness settings.
- Flash memory for 255 pictures and attributes.
- Reports switch activities via serial port.
- Stand alone operation or real time control by host.

Switch-action report from the controller to the host:

- Default switch press event (1 byte in the form of 80H + LCD Module #).
- Default switch release event (1 byte in the form of B0H + LCD Module #).
- Default image press event (2 byte indicating location).
- Default image release event (2 byte indicating location).
- User-defined switch press event report (up to 15 bytes).
- User-defined switch release event report (up to 15 bytes).
- User-defined picture press event report (up to 15 bytes).
- User-defined picture release event report (up to 7 bytes).

Set-up options:

- Adjustable audio feedback while switch is pressed.
- User-defined backlight color while switch is pressed.
- User-defined font 5x7 (256 character).
- User-defined font 7x10(256 character).
- User-defined backlighting blinking rate.
- User-defined backlighting on-to-off ratio.
- Option to continue the last state before power-down/reboot.

Real-time operation features:

- Download image data to any address.
- Select image display for each LCD module.

- Download characters and controller will create graphic data using 5x7 font for any address.
- Download characters and controller will create graphic data using 7x10 font for any address.
- Control any single pixel on any LCD module.
- Change backlight color on any LCD module.

2. Compatible Logic Boards

Switch Logic Boards: PCB's with mounted switches or displays that are used for this controller are called Logic Boards. There are many Logic Boards available. All the Logic Boards have two 7x2 connectors and can be daisy chained via 14 pin ribbon cables. JP2 of the IS-C1603 gets connected to J1 of the first Logic Board, J2 of the first Logic Board gets connected to J1 of the second Logic Board and so on. The red wire of the ribbon cable, indicating pin 1, must be connected to pin 1 for all connections. There are two types of Logic Boards, 2 bits and 4 bits. Only one type of board can be used at any one time. The J2 jumper is used to select which type of logic boards will be used with the IS-C1603. If the jumper is not selected properly or the two types of logic boards are mixed together unpredictable behavior will result.

The following is a list of compatible Logic Boards and switches.

RGB, 4 bit:

- A. IS-L0204-C Two LCD 36x24 RGB, 4 bit
- B. IS-L0251-C Two LCD 36x24 RGB Display, 4 bit
- C. IS-L0271-C Two LCD 36x24 RGB Compact, 4 bit
- D. IS-L0107-IS15ABFP4RGB One LCD 36x24 RGB, 4 bit.

Bicolor/single color, 4 bit:

- E. IS-L0205-C Two LCD 36x24 Bicolor/single color, 4 bit

Bicolor/single color, 2 bit:

- F. IS-L0102-SW# One LCD 36x24 Bicolor/single color, 2 bit. No mounting hole. Must be used with Panel Mount housing.
- G. IS-L0103-C One LCD 36x24 Bicolor/single color, 2 bit.
- H. IS-L0201-C Two LCD 36x24 Bicolor/single color, 2 bit, 1x2 (VxH) (spacing between the switches).
- I. IS-L0301-C Three LCD 36x24 Bicolor/single color, 2 bit, 1x3 (VxH).
- J. IS-L0302-C Three LCD 36x24 Bicolor/single color, 2 bit, 3x1 (VxH).
- K. IS-L0401-C Four LCD 36x24 Bicolor/single color, 2 bit, 2x2 (VxH), side by side stackable.
- L. IS-L0601-C Six LCD 36x24 Bicolor/single color, 2 bit, 2x3 (VxH).
- M. IS-L0901-C Nine LCD 36x24 Bicolor/single color, 2 bit, 3x3 (VxH), side by side stackable.
- N. IS-L1002-C Ten LCD 36x24 Bicolor/single color, 2 bit, 5x2 (VxH), side by side stackable.
- O. IS-L1502-C Fifteen LCD 36x24 Bicolor/single color, 2 bit, 5x3 (VxH), side by side stackable.

New Logic Boards can be designed based on customer requirements.

Note: Make sure the power is off when connecting or disconnecting the Logic Boards to or from the controller or each other.

Note: Improper installation of the Logic Boards could damage either/both the Logic Boards and controller.

3. Operational Detail

Power-up Sequence:

Each switch has a Pointer. There are 255 addresses in the memory (01H to FFH). Each Address holds a Page of data. Each Page has a Legend Block (image data), LCD/LED code, control code, Attribute block, and user-defined look-up tables.

Upon power-up the data from Page 1 is displayed on switch 1, the data from Page 2 is displayed on switch 2 and so on up to Page 16 which is displayed on switch 16.

The display data for the switches are refreshed from the Page data. The LCD/LED codes are transferred to an intermediate buffer for refresh. Therefore any command from host that make changes to the images will go to effect immediately but any command from host that changes the LCD/LED code in a Page will go to effect immediately only if it also transfers the code to intermediate buffer.

After power-up or reset, the controller transmits 11H. This lets the host know that the controller is on line and ready for commands.

The controller then waits for a switch action or a command from the host before updating the switches' displays.

Main Operational Mode:

The controller takes the following actions upon a switch press/release.

1. Switch Release:

- A. If bit 0 of FLAG-A is enabled (default: enabled), transmit (Switch # + B0H) to host in HEX format.
- B. If bit 2 of FLAG-C is enabled (default: disabled), transmit to host up to a maximum of 16 characters or until there is a null character in HEX format from user-defined switch release look-up table associated with the switch number.
- C. If bit 0 of FLAG-C is enabled (default: disabled), transmit to host in ASCII HEX format the Pointer value of the image being displayed.
- D. If bit 1 of FLAG-C is enabled (default: disabled), transmit to host up to a maximum of 8 characters or until there is a null character in HEX format from user-defined image release look-up table associated with the Pointer.
- E. If bit 5 of FLAG-A is enabled (default: enabled) and bit 2 of FLAG-B is equal to one (default: 0) then do the following:
 1. Use current Pointer to find the associated Address, if the viewing angle/ brightness code is not zero, then increase or decrease the brightness accordingly.
 2. Update the Pointers with the Addresses from the Attribute Block in the Page of the displaying Image. If any of the Addresses in the attribute block is equal to zero do not change that Pointer.

3. If bit 0 of FLAG-B is enabled (default: enabled), update the LCD/LED codes for the switches according to updated Pointers.
2. Switch Closure:
 - A. If bit 1 of FLAG-A is enabled (default: enabled), transmit (Switch # + 80H) to host in HEX format.
 - B. If bit 2 of FLAG-A is enabled (default: disabled), transmit to host up to a maximum of 15 characters or until there is a null character in HEX format from user-defined switch press look-up table associated with the switch number.
 - C. If bit 3 of FLAG-A is enabled (default: disabled), transmit to host in ASCII HEX format the Pointer value of the image being displayed.
 - D. If the bit 4 of FLAG-A is enabled (default: disabled), transmit to host up to a maximum of 15 characters or until there is a null character in HEX format from user-defined image press look-up table associated with the Pointer.
 - E. If bit 5 of FLAG-A is enabled (default: enabled) and bit 2 of FLAG-B is zero (default: 0) then do the following:
 1. Use current Pointer to find the associated Address, if the viewing angle/ brightness code is not zero, then increase or decrease the brightness accordingly.
 2. Update the Pointers with the Addresses from the Attribute Block in the Page of the displaying Image. If any of the Addresses in the attribute block is equal to zero do not change that Pointer.
 3. If bit 0 of FLAG-B is enabled (default: enabled), update the LCD/LED codes for the switches according to updated Pointers.

Attribute Block for 36x24 Resolution Switches

A block of 16 bytes representing the future Addresses for the 16 Pointers.

Byte	Description
1	Address for LCD Module #1 when switch is pressed.
2	Address for LCD Module #2 when switch is pressed
•	
•	
15	Address for LCD Module #15 when switch is pressed.
16	Address for LCD Module #16 when switch is pressed.

Legend Block for 36x24 Resolution Switches:

A block of 125 bytes. It contains picture data and LED codes.

Byte	Description
1-5	First line of picture
6-10	Second line of picture
•	
•	
•	
116-120	24th line of picture
121	LED code
122	Viewing angle/brightness code
123-125	reserved

Picture Block:

A block of 120 bytes (subset of the Legend Block). There are five bytes of data for each pixel-row of LCD module. The least significant nibble of the fifth byte is not used. The most significant bit of the first byte will be displayed as the leftmost pixel of pixel-row of LCD module.

LED Backlighting for 36x24 Resolution Switches:

The LED code is one byte with the following format:

B7=0 ==> Reserved
 B7=1 ==> Reserved

B6=0 ==> Blue backlighting off during "OFF CYCLE"
 B6=1 ==> Blue backlighting on during "OFF CYCLE"

B5=0 ==> Green backlighting off during "OFF CYCLE"
 B5=1 ==> Green backlighting on during "OFF CYCLE"

B4=0 ==> Red backlighting off during "OFF CYCLE"
 B4=1 ==> Red backlighting on during "OFF CYCLE"

B3=0 ==> LCD normal
 B3=1 ==> LCD inverse

B2=0 ==> Blue backlighting off during "ON CYCLE"
 B2=1 ==> Blue backlighting on during "ON CYCLE"

B1=0 ==> Green backlighting off during "ON CYCLE"
 B1=1 ==> Green backlighting on during "ON CYCLE"

B0=0 ==> RED backlighting off during "ON CYCLE"
 B0=1 ==> RED backlighting on during "ON CYCLE"

**NOTE: For bicolor LED's B2 & B6 are not used.
 B0 & B4 are for LED of the switch, pin 3.
 B1 & B5 are for LED of the switch, pin 13.**

Control Code (Brightness adjustment):

A byte with the following format:

- B0, B1, B4, B5, B6 and B7 are reserved and should be zero
- B3=0 ==> No change
- B3=1 ==> Increase backlight brightness
- B2=0 ==> No change
- B2=1 ==> Decrease backlight brightness

LCD/LED Block

A block of 16 LCD/LED codes. The backlighting and LCD display mode for the 16 LCD modules.

Byte	Description
1	LCD/LED code for LCD module #1
2	LCD/LED code for LCD module #2
•	
•	
15	LCD/LED code for LCD module #15
16	LCD/LED code for LCD module #16

4. Communication Protocol

The controller communicates with the host by serial communication via RS232. The controller receives the data via an interrupt routine that places the data on the circular receive buffer. When the controller detects data in the circular receive buffer, at Step 5G, it reads one byte and executes the following:

- A. If the byte is a command, the controller transmits a 61H and executes the subroutine for the command and upon completion of command the controller transmits 79H. All of the commands are explained in detail in this section.
- B. If the byte is not a command, it is ignored.

When the controller executes a subroutine and expects additional information:

- A. A timer is set. If the expected data byte is not received in 50ms, the controller transmits 6EH and terminates the routine.
- B. If the byte value is not acceptable (invalid range, option, etc.), the controller transmits 6EH and terminates the routine.

Commands are one byte in the range of 20H to 2FH and 01H and are transmitted in hex format. The proper format for all command options and data is specified for each command.

Commands to the controller

1. Commands that do not alter the data in the memory addresses:

Command to reboot the controller

The command reboots the controller to power-up state.

command format: **24H**
transmit format: (xxH)

Command to check communication

The command is used to check if the controller is on-line.

command format: **01H**
transmit format: (xxH)

The controller transmits back 61H to the host.

Command to upload a Legend Block

This command uploads a Legend block from the EEPROM location to the host.

command format: **29H** [Address]
transmit format: (xxH) (xxAH)

[Address] is one byte with value of 01H to FFH and must be sent in ASCII HEX format.

The controller transmits back the image, 125 bytes in standard resolution mode, in HEX format.

Command to upload the Pointer values of all 16 Modules

This command uploads the Pointer values in ASCII HEX format.

command format: **2DH** 52H
transmit format: (xxH) (xxH)

Command to upload Pointer value at specified Module

This command uploads the Pointer value in ASCII HEX format.

command format: **2EH** 52H [Module #]
transmit format: (xxH) (xxH) (xxAH)

[Module #] is one byte with value of 01H to 10H and must be sent in ASCII hex format.

Command to upload LCD/LED codes of all 16 Modules

This command uploads the LCD/LED codes in ASCII HEX format.

command format: **2CH** 52H
transmit format: (xxH) (xxH)

Command to upload LCD/LED Code at specified Module

This command uploads the Pointer value in ASCII HEX format.

command format: **2FH** 52H [Module #]
transmit format: (xxH) (xxH) (xxAH)

[Module #] is one byte with value of 01H to 10H and must be sent in ASCII HEX format.

Command to upload an attribute block for an Address

This command uploads an Attribute Block from the EEPROM location to the host.

command format: **2BH** [Address]
transmit format: (xxH) (xxAH)

[Address] is one byte with value of 01H to FFH and must be sent in ASCII HEX format.

Upon receiving this command the controller transmits back the [Attribute Block] which is six bytes in ASCII HEX format.

2. Operation Commands

Command to download Pointer values for all 16 Modules

This command downloads the 16 Pointer values. If the Pointer value is zero then the corresponding Pointer is left unchanged.

command format: **2DH** 30H [Pointer Block]
transmit format: (xxH) (xxH) (xxAH)

[Pointer Block] is 16 bytes of address values for the Pointers and must be sent in ASCII HEX format.

Command to download one Pointer value to specified Module

This command downloads the Pointer value for specified module.

command format: **2EH** 30H [Module #] [Address]
transmit format: (xxH) (xxH) (xxAH) (xxAH)

[Module #] is one byte with value of 01H to 10H and must be sent in ASCII HEX format.

[Address] is one byte with value of 01H to FFH and must be sent in ASCII HEX format.

Command to set LCD/LED codes for all 16 Modules

This command sets the 16 LCD/LED codes.

command format: **2CH** 30H [LCD/LED code block]
transmit format: (xxH) (xxH) (xxAH)

[LCD/LED code block] is 16 bytes of LCD/LED data, one for each Module, and must be sent in ASCII HEX format.

This command sets the 16 LCD/LED codes in the LCD/LED refresh buffer. If the value of a LCD/LED code is zero, the corresponding code in the refresh buffer is left unchanged. If an update is desired for the value of zero, Bit 7 should be set to 1.

Command to download one LCD/LED Code to specified Module

This command sets the LCD/LED code for specified module.

command format: **2FH** 30H [Module #] [LCD/LED code]
transmit format: (xxH) (xxH) (xxAH) (xxAH)

[Module #] is one byte with value of 01H to 10H and must be sent in ASCII HEX format.

[LCD/LED code] is one byte with value of 01H to FFH and must be sent in ASCII HEX format.

3. Commands to download the pictures, LCD/LED codes and control codes.

Command to download a Legend block

This command downloads a Legend Block from the host to the EEPROM location.

command format: **28H** [Address] [Legend Block]
transmit format: (xxH) (xxAH) (xxAH)

[Address] is one byte with value of 01H to FFH and must be sent in ASCII HEX format.

[Legend Block] is 125 bytes and must be sent in ASCII HEX format.

The LCD/LED code is not transferred to LCD/LED code refresh block.

Command to clear the Image data at a specified Address

This command sets all the bits in the image data at a specified Address to zero (off).

command format: **27H** [Address] [00H]
transmit format: (xxH) (xxAH) (xxAH)

[Address] is one byte with value of 01H to FFH and must be sent in ASCII HEX format.

[00H] is two byte and must be sent in ASCII HEX format (30 30).

Command to fill the Image data at a specified Address

This command sets all the bits in the image data at a specified Address to one (on).

command format: **27H** [Address] [01H]
transmit format: (xxH) (xxAH) (xxAH)

[Address] is one byte with value of 01H to FFH and must be sent in ASCII HEX format.
[01H] is two byte and must be sent in ASCII HEX format (30 31).

Command to download one LCD/LED Code to specified Address

This command sets the LCD/LED code for specified Address.

command format: **27H** [Address] [09H] [LCD/LED code]
transmit format: (xxH) (xxAH) (xxAH) (xxAH)

[Address] is one byte with value of 01H to FFH and must be sent in ASCII HEX format.
[09H] is two byte and must be sent in ASCII HEX format (30 39).
[LCD/LED code] is one byte with value of 01H to FFH and must be sent in ASCII HEX format.
The LCD/LED code is not transferred to LCD/LED code refresh block.

Command to clear a pixel within an image

This command sets a pixel within an image to zero (off) at a specified address.

command format: **27H** [Address] [02H] [column] [row]
transmit format: (xxH) (xxAH) (xxAH) (xxAH) (xxAH)

[Address] is one byte with value of 01H to FFH and must be sent in ASCII HEX format.
[02H] is two byte and must be sent in ASCII HEX format (30 32).
[column] is one byte with value of 01H to 24H and must be sent in ASCII HEX format.
[row] is one byte with value of 00H to 17H and must be sent in ASCII HEX format.

Command to fill a pixel within an image

This command sets a pixel within an image to one (on) at a specified address.

command format: **27H** [Address] [03H] [column] [row]
transmit format: (xxH) (xxAH) (xxAH) (xxAH) (xxAH)

[Address] is one byte with value of 01H to FFH and must be sent in ASCII HEX format.
[03H] is two byte and must be sent in ASCII HEX format (30 33).
[column] is one byte with value of 01H to 24H and must be sent in ASCII HEX format.
[row] is one byte with value of 00H to 17H and must be sent in ASCII HEX format.

Command to download and insert data for the left column of a picture

This command inserts one column of pixel data to the left side of the image. All the columns shift to the right. The right most column pixel data is lost

command format: **27H** [Address] [07H] [pixel data]
transmit format: (xxH) (xxAH) (xxH) (xxAH)

[Address] is one byte with value of 01H to FFH and must be sent in ASCII HEX format.

[07H] is two byte and must be sent in ASCII HEX format (30 37).

[pixel data] is three bytes representing the 24 pixels in the column. The top-most pixel is the most significant bit of first byte. The values must be sent in ASCII HEX format.

Command to download Attribute data to a specified Address

This command downloads the Attribute data to a specified Address.

command format: **2AH** [Address] [Attribute block]
transmit format: (xxH) (xxAH) (xxAH)

[Address] is one byte with value of 01H to FFH and must be sent in ASCII HEX format.

[Attribute block] is 16 bytes of Addresses and must be sent in ASCII HEX format.

Command to set the Images displayed at power up.

This command downloads the Attribute data to a specified Address.

command format: **21H** [CCH] [power up Addresses]
transmit format: (xxH) (xxAH) (xxAH)

[CCH] is two byte and must be sent in ASCII HEX format (43 43).

[power up Addresses] is 16 bytes of Pointer values indicating what Addresses and associated Images and Page data will be displayed upon power up or reboot. The values are from 01H to FFH and must be sent in ASCII HEX format. The default values are 01H, 02H, 03H, ..., ..., 0EH, 0FH, 10H.

4. Commands to display look-up table characters at selected address.

The controller can generate an image using the font look-up tables. The default look-up tables are ASCII character values 20H to 7FH in fonts 5x7 and 7x10. The user can modify the default look-up tables as well as create a user-defined look-up table for remainder of the values from 00H to FFH. Each image can hold three lines of 6 characters in font 5x7 or two lines of 4 characters in font 7x10.

In font 7x10, the actual character picture is 10 pixel-rows high. It's padded by an extra pixel-row on the top and bottom. These padded pixel-rows are clear (off) during "normal mode" and filled (on) during "reverse mode" to provide line spacing between character-rows. In font 5x7, the actual character picture is 7 pixel-rows high. It's padded on the top only with a clear (off) pixel-row to provide line spacing between character-rows.

Command to display 18 characters for three lines of font 5x7

This command sets the image data at a specified address with 3 lines of 18 characters of font 5x7.

command format: **27H** [Address] [08H] [ASCII string]
transmit format: (xxH) (xxAH) (xxAH) (xxH)

[Address] is one byte with value of 01H to FFH and must be sent in ASCII HEX format.

[08H] is two byte and must be sent in ASCII HEX format (30 38).

[ASCII string] is 18 bytes and is a string of font 5x7 look-up table indexes. It must be sent in HEX format.

Command to display 6 characters for the first line of font 5x7

This command sets the image data at a specified address with the first line of 6 characters of font 5x7.
No changes made to other lines.

command format: **27H** [Address] [0EH] [ASCII string]
transmit format: (xxH) (xxAH) (xxAH) (xxH)

[Address] is one byte with value of 01H to FFH and must be sent in ASCII HEX format.

[0EH] is two byte and must be sent in ASCII HEX format (30 45).

[ASCII string] is 6 bytes and is a string of font 5x7 look-up table indexes. It must be sent in HEX format.

Command to display 6 characters for the second line of font 5x7

This command sets the image data at a specified address with the second line of 6 characters of font 5x7.
No changes made to other lines.

command format: **27H** [Address] [0FH] [ASCII string]
transmit format: (xxH) (xxAH) (xxAH) (xxH)

[Address] is one byte with value of 01H to FFH and must be sent in ASCII HEX format.

[0FH] is two byte and must be sent in ASCII HEX format (30 46).

[ASCII string] is 6 bytes and is a string of font 5x7 look-up table indexes. It must be sent in HEX format.

Command to display 6 characters for the third line of font 5x7

This command sets the image data at a specified address with the third line of 6 characters of font 5x7.
No changes made to other lines.

command format: **27H** [Address] [10H] [ASCII string]
transmit format: (xxH) (xxAH) (xxAH) (xxH)

[Address] is one byte with value of 01H to FFH and must be sent in ASCII HEX format.

[10H] is two byte and must be sent in ASCII HEX format (31 30).

[ASCII string] is 6 bytes and is a string of font 5x7 look-up table indexes. It must be sent in HEX format.

Command to display 8 characters for two lines of font 7x10

This command sets the image data at a specified address with two lines of 4 characters each of font 7x10.

command format: **27H** [Address] [04H] [ASCII string]
transmit format: (xxH) (xxAH) (xxAH) (xxH)

[Address] is one byte with value of 01H to FFH and must be sent in ASCII HEX format.

[04H] is two byte and must be sent in ASCII HEX format (30 34).

[ASCII string] is 8 bytes and is a string of font 7x10 look-up table indexes. It must be sent in HEX format.

Command to display 8 characters for two lines of font 7x10 with first line in inverse mode.

This command sets the image data at a specified address with two lines of 4 characters each of font 7x10. The first line is white characters on black background. The second line is black characters on white background.

command format: **27H** [Address] [06H] [ASCII string]
transmit format: (xxH) (xxAH) (xxAH) (xxH)

[Address] is one byte with value of 01H to FFH and must be sent in ASCII HEX format.

[06H] is two byte and must be sent in ASCII HEX format (30 36).

[ASCII string] is 8 bytes and is a string of font 7x10 look-up table indexes. It must be sent in HEX format.

Command to display 4 characters for the first line of font 7x10

This command sets the image data at a specified address with the first line of 4 characters of font 7X10. No changes made to the other line.

command format: **27H** [Address] [0AH] [ASCII string]
transmit format: (xxH) (xxAH) (xxAH) (xxH)

[Address] is one byte with value of 01H to FFH and must be sent in ASCII HEX format.

[0AH] is two byte and must be sent in ASCII HEX format (30 41).

[ASCII string] is 4 bytes and is a string of font 7x10 look-up table indexes. It must be sent in HEX format.

Command to display 4 characters for the second line of font 7x10

This command sets the image data at a specified address with the second line of 4 characters of font 7X10. No changes made to the other line.

command format: **27H** [Address] [0BH] [ASCII string]
transmit format: (xxH) (xxAH) (xxAH) (xxH)

[Address] is one byte with value of 01H to FFH and must be sent in ASCII HEX format.

[0BH] is two byte and must be sent in ASCII HEX format (30 42).

[ASCII string] is 4 bytes and is a string of font 7x10 look-up table indexes. It must be sent in HEX format.

Command to display 4 characters for the first line of font 7x10 in inverse mode.

This command sets the image data at a specified address with the first line of 4 characters of font 7X10. The first line is white characters on black background. No changes made to the other line.

command format: **27H** [Address] [0CH] [ASCII string]
transmit format: (xxH) (xxAH) (xxAH) (xxH)

[Address] is one byte with value of 01H to FFH and must be sent in ASCII HEX format.

[0CH] is two byte and must be sent in ASCII HEX format (30 43).

[ASCII string] is 4 bytes and is a string of font 7x10 look-up table indexes. It must be sent in HEX format.

Command to display 4 characters for the second line of font 7x10 in inverse mode.

This command sets the image data at a specified address with the second line of 4 characters of font 7X10. The second line is white characters on black background. No changes made to the other line.

command format: **27H** [Address] [0DH] [ASCII string]
transmit format: (xxH) (xxAH) (xxAH) (xxH)

[Address] is one byte with value of 01H to FFH and must be sent in ASCII HEX format.

[0DH] is two byte and must be sent in ASCII HEX format (30 44).

[ASCII string] is 4 bytes and is a string of font 7x10 look-up table indexes. It must be sent in HEX format.

5. Commands to download to Look-up tables.

a. Switch Report Look-up Table:

Command to download user-defined Switch Press event for a switch.

This command sets user-defined actions taken when the specified switch is pressed using the look-up table.

command format: **21H** [AAH] [Module #] [number] [string]
transmit format: (xxH) (xxAH) (xxAH) (xxH) (xxH)

[AAH] is two byte and must be sent in ASCII HEX format (41 41).

[Module #] is one byte with value of 01H to 10H and must be sent in ASCII HEX format.

[number] is one byte which indicates the number of bytes. Only the lower nibble is used.

[string] may consist of up to a maximum of 15 bytes according to the lower nibble of the [number].

All default values for this section are 00H.

Command to download user-defined Switch Release event for a switch.

This command sets user-defined actions taken when the specified switch is released using the look-up table.

command format: **21H** [ABH] [Module #] [number] [string]
transmit format: (xxH) (xxAH) (xxAH) (xxH) (xxH)

[ABH] is two byte and must be sent in ASCII HEX format (41 42).

[Module #] is one byte with value of 01H to 10H and must be sent in ASCII HEX format.

[number] is one byte which indicates the number of bytes. Only the lower nibble is used.

[string] may consist of up to a maximum of 15 bytes according to the lower nibble of the [number].

All default values for this section are 00H.

Command to download user-defined Image Press event for an address.

This command sets user-defined actions taken when any switch with the Image associated with the specified address is pressed using the look-up table.

command format: **21H** [BBH] [Address] [number] [string]
transmit format: (xxH) (xxAH) (xxAH) (xxH) (xxH)

[BBH] is two byte and must be sent in ASCII HEX format (42 42).

[Address] is one byte with value of 01H to FFH and must be sent in ASCII HEX format.

[number] is one byte which indicates the number of bytes. Only the lower nibble is used. If B4=1 then the string will be repeatedly send while the Image is pressed.

[string] may consist of up to a maximum of 15 bytes according to the lower nibble of the [number].

All default values for this section are 00H.

Command to download user-defined Image Release event for an address.

This command sets user-defined actions taken when any switch with the Image associated with the specified address is released using the look-up table.

command format: **21H** [BCH] [Address] [number] [string]
transmit format: (xxH) (xxAH) (xxAH) (xxH) (xxH)

[BCH] is two byte and must be sent in ASCII HEX format (42 43).

[Address] is one byte with value of 01H to FFH and must be sent in ASCII HEX format.

[number] is one byte which indicates the number of bytes. Only the lower nibble is used. If B4=1 then the string will be repeatedly send while the Image is pressed.

[string] may consist of up to a maximum of 15 bytes according to the lower nibble of the [number].

All default values for this section are 00H.

b. Font-Set Look-up Table:

There are 256 fonts (00H to FFH) in each font set. The default bit map look-up tables are created for English ASCII characters (20H to 7FH). The default values for rest of the fonts are 00H.

Command to download a font to the look-up table for font 5x7

This command sets a font set's values and graphic and stores it in the look-up table of font 5x7.

command format: **21H** [BEH] [font value] [font bitmap]
 transmit format: (xxH) (xxAH) (xxAH) (xxH)

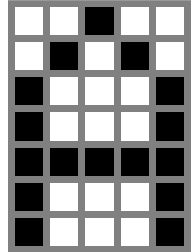

[BEH] is two byte and must be sent in ASCII HEX format (42 45).

[font value] is one byte with value of 00H to FFH and must be sent in ASCII HEX format. It is the look-up table index.

[font bitmap] is 7 bytes making up a character graphic. The first byte is the top row of the character graphic and the 7th byte is the bottom row of the character graphic. The B7 of each byte of the character graphic data is the leftmost column of the character graphic. B2, B1 and B0 are not used and should be set to zero.

Example: (21 4245 3030 20 50 88 88 F8 88 88) sends the above illustration to look-up table index 00.

Command to download a font to the look-up table for font 7x10

This command sets a font set's values and graphic and stores it in the look-up table of font 7x10.

command format: **21H** [BDH] [font value] [font bitmap]
 transmit format: (xxH) (xxAH) (xxAH) (xxH)

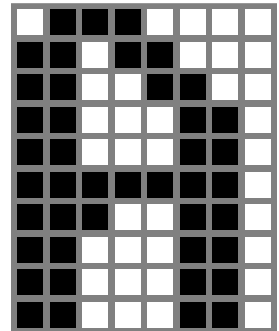

[BDH] is two byte and must be sent in ASCII HEX format (42 44).

[font value] is one byte with value of 00H to FFH and must be sent in ASCII HEX format. It is the look-up table index.

[font bitmap] is 10 bytes making up a character graphic. This font is actually 8x10 font so all 8 bits of each character graphic byte are used. The first byte is the top row of the character graphic and the 10th byte is the bottom row of the character graphic. The B7 of each byte of the character graphic data is the leftmost column of the character graphic.

Example: (21 4244 3030 70 D8 CC C6 C6 FE E6 C6 C6 C6) sends the above illustration to look-up table index 00.

6. Download Set-up Values

Command to set LCD/LED Code for a switch press event.

This command sets the LCD/LED Code for when any switch is pressed. Bit 3 of Flag-B must be set to 1 to enable (the default is 0).

command format: **21H** [E3H] [LCD/LED code] [LCD/LED code]
 transmit format: (xxH) (xxAH) (xxAH) (xxAH)

[E3H] is two byte and must be sent in ASCII HEX format (45 33).

[LCD/LED code] is one byte and must be sent twice in ASCII HEX format. The default color is green (11).

Command to set the time delay between commands.

This command sets the timer value for the time between commands.

command format: **21H** [E4H] [Timer value] [Timer value]
 transmit format: (xxH) (xxAH) (xxAH) (xxAH)

[E4H] is two byte and must be sent in ASCII HEX format (45 34).

[Timer value] is one byte sent twice and must be sent in ASCII HEX format. The default value is 80H. The actual time is 20ms times this Timer value. To enable this feature, bit 7 of Flag-C must be set to 1 (the default is 0).

Command to set the time for LED's Off Cycle duration.

This command sets the timer value for the duration of the LED's Off Cycle.

command format: **21H** [E1H] [Timer value] [Timer value]
 transmit format: (xxH) (xxAH) (xxAH) (xxAH)

[E1H] is two byte and must be sent in ASCII HEX format (45 31).

[Timer value] is one byte with value of 01H to FFH sent twice and must be sent in ASCII HEX format. The default value is 40H.

Off Cycle Duration = 7 (Timer value) ms.

Command to set the On Cycle/Off Cycle ratio.

This command sets the timer value for the duration of the LED's Off Cycle.

command format: **21H** [E2H] [Ratio] [Ratio]
 transmit format: (xxH) (xxAH) (xxAH) (xxAH)

[E2H] is two byte and must be sent in ASCII HEX format (45 32).

[Ratio] is one byte with value of 01H to FFH sent twice and must be sent in ASCII HEX format. The default value is 03H. The ratio value determines the On Cycle duration for LED's.

On Cycle Duration = (Ratio) (Off Cycle duration) ms.

7. Animated Images

For animated Images to be activated bit 7 of Flag-A must be set.

A Module with a Pointer value above 127 (7FH) will have its image continuously step through 8 Addresses.

The alternating addresses are as follow:

80H to 87H, 88H to 8FH, 90H to 97H,.....,F0H to F7H,F8H to FFH

The alternating time is determined based on two user-defined variables and a constant.

Alternating time in ms = (20) (Animation Timer) (Animation Multiplier)

Command to set the Animation Timer.

This command sets the timer value for animations.

command format: **21H** [98H] [Animation Timer] [Animation Timer]
 transmit format: (xxH) (xxAH) (xxAH) (xxAH)

[98H] is two byte and must be sent in ASCII HEX format (39 38).

[Animation Timer] is one byte and must be sent twice in ASCII HEX format. The default value is 10H.

Command to set the Animation Multiplier.

This command sets the multiplier value for animations.

command format: **21H** [99H] [Animation Multiplier] [Animation Multiplier]
 transmit format: (xxH) (xxAH) (xxAH) (xxAH)

[99H] is two byte and must be sent in ASCII HEX format (39 39).

[Animation Multiplier] is one byte and must be sent twice in ASCII HEX format. The default value is 05H.

Command to set the Repeat timer for user-defined Image Press event.

This command sets the time between repeated transmissions of the user-defined Image press event data when the Image is pressed.

command format: **21H** [ECH] [Timer] [Timer]
 transmit format: (xxH) (xxAH) (xxAH) (xxAH)

[ECH] is two byte and must be sent in ASCII HEX format (45 43).

[Timer] is one byte and must be sent twice in ASCII HEX format. The default value is 08H. Approximate time is Timer x 20ms.

Command to set the number of Modules attached to the controller.

This command sets the number of Modules attached to the controller.

command format: **21H** [E9H] [# of Modules] [# of Modules]
 transmit format: (xxH) (xxAH) (xxAH) (xxAH)

[E9H] is two byte and must be sent in ASCII HEX format (45 39).

[# of Modules] is one byte with value of 01H to 10H and must be sent twice in ASCII HEX format. This command goes into effect after the following power up / reboot.

8. Setting the Flags

The controller features can be customized based on customer requirements by manipulating the settings of the Flags. There are three Flag bytes and a command for setting each Flag. The changes go into effect after the following power up / reboot.

Command to set a Flag.

This command sets a flag which controls the features of the controller.

command format: **21H** [Option] [Flag Byte] [Flag Byte]
 transmit format: (xxH) (xxAH) (xxAH) (xxAH)

[Option] = EEH (45 45) Flag Byte A (Flag-A)
 [Option] = EFH (45 46) Flag Byte B (Flag-B)
 [Option] = EDH (45 44) Flag Byte C (Flag-C)

[Flag Byte] is one byte and must be sent twice in ASCII HEX format. This command writes the downloaded flag data to storage memory. The changes go into effect after the following power up / reboot.

Flag Byte A Default Value=63H

Bit	Enable Value	Flag	Controller action when flag is set
B0	1	Default Switch release report	Reports switch release events (Module # + B0H) in XXH format.
B1	1	Default Switch press event report	Reports switch press events (Module # + B0H) in XXH format.
B2	1	User-defined Switch press event report	Transmits user-defined data for that switch upon switch press event in XXH format.
B3	1	Default Image press event report	Transmits Pointer value upon switch press event in XXAH format.
B4	1	User-defined Image press event report	Transmits user-defined data for that Image upon Image press event in XXH format.
B5	1	Execute Attribute for Switch press/release event enable	Executes viewing angle/brightness code and updates pending Pointer values if non-zero.
B6	1	Switch press event beep enable	Provides audio feedback through the audio connector upon any switch press event.
B7	1	Animated Images operation mode enable	Fills/clears displays and changes backlighting colors upon power-up or reset.

Flag Byte A bit settings:

B0=0 ---> No transmission.

B0=1 ---> Upon switch release, transmit one byte (B0H+switch number).

B1=0 ---> No transmission.

B1=1 ---> Upon switch press, transmit one byte (80H+switch number).

B2=0 ---> No transmission.

B2=1 ---> Upon switch press, transmit from the user-defined switch press event data. Up to 16 bytes or until a byte value is 00H.

B3=0 ---> No transmission.

B3=1 ---> Upon switch press, transmit the Pointer value of the Module in ASCII HEX format.

B4=0 ---> No transmission.

B4=1 ---> Upon switch press, transmit from the user-defined Image press event data. Up to 16 bytes or until a byte value is 00H.

B5=0 ---> Do not execute the Attributes.

B5=1 ---> Execute Attributes upon switch press or release based on the status of Flag-B bit 2.

B6=0 ---> Disable buzzer.

B6=1 ---> Enable buzzer. Beep when any switch is pressed.

B7=0 ---> Normal operation mode.

B7=1 ---> Animated Image operation. A Module with a Pointer value above 127 (7FH) will have its image continuously step through 8 Addresses. The alternating addresses are as follow:

80H to 87H, 88H to 8FH, 90H to 97H,.....,F0H to F7H,F8H to FFH

The alternating time is determined based on two user-defined variables and a constant.

Alternating time in ms = (20) (Animation Timer) (Animation Multiplier)

Flag Byte B Default Value=60H

Bit	Enable Value	Flag	Controller action when flag is set
B0	0	LCD/LED code from storage	Uses the LCD/LED Code from storage. Default is enabled.
B1	1	Power-up Pointer values	Upon power-up/reboot use the pointer values that were in effect before power down/reboot.
B2	1	Execute Attribute for Switch press/release event	Execute Attribute upon switch release instead of switch press event, Flag-A bit5 must be set.
B3	1	LED Image press event	LED backlight change to user-defined color when a switch is pressed.
B4	1	XON/XOFF enable	Uses XON/XOFF protocol to communicate. Bit B7 must be enabled.
B5	1	79H flag	79H is transmitted upon completion of command.
B6	1	61H flag	61H is transmitted in response to command.
B7	1	Controller polling	Uses XON/XOFF protocol to communicate. Bit B4 must be enabled.

Flag Byte B bit settings:

B0=0 ---> When executing attribute pointers, the Controller pull the LCD/LED code from Pages to refresh Buffer.

B0=1 ---> Do not use LCD/LED codes from pages.

B1=0 ---> Upon power up/ reboot, use the pointers that were in effect before power down/ reboot.

B1=1 ---> Upon power up/ reboot, use the pointers from Power-up look up table.

B2=0 ---> Execute Attributes upon switch press event.

B2=1 ---> Execute Attributes upon switch release event.

B3=0 ---> No action.

B3=1 ---> While switch is pressed change the backlighting to user-defined color.

B5=0 ---> No transmission.

B5=1 ---> Upon completion of a command from host, the controller transmits 79H in XXH format.

B6=0 ---> No transmission.

B6=1 ---> Upon receipt of a command byte (20H to 2FH) from host, the controller transmits 61H in XXH format. Regardless of B6 setting, the controllers transmit 61H in respond to Command 01H from host. RS422 only.

B4, B7 -->These two bits are for polling operation. Both bits must be set to 1 for proper operation. Use XON and XOFF for communication. The controller stops transmitting upon receiving 13H and resumes transmitting upon receiving 11H. The transmit buffer is 256 bytes. The data will be lost if more than 256 bytes is to be transmitted. RS422 only.

Flag Byte C Default Value=00H

Bit	Enable Value	Flag	Controller action when flag is set
B0	1	Default Image release report	Transmits Pointer value upon Image release event in XXAH format.
B1	1	User-defined Image release report	Transmits user-defined data for that switch upon switch release event in XXH format.
B2	1	User-defined switch release report	Transmits user-defined data for that switch upon switch release event in XXH format.
B3	1	User-defined Image press event repeat	Repeatedly transmits user-defined Image press event data upon Image press event in XXH format.
B4	1	Multi-Drop	Multi-Drop.
B5	1	Multi-Drop transmission	Multi-Drop transmission.
B6	1	Timer for command 26H	Controller waits for additional optional bytes until user-defined timer expires.

B7	1	Continuous command operation mode	Turn all the Module backlighting blinking red if no command from host is received within user-define time interval.
----	---	-----------------------------------	---

Flag Byte C bit settings:

B0=0 ---> No transmission.

B0=1 ---> Upon switch release, transmit Pointer value of the switch in ASCII HEX format.

B1=0 ---> No transmission.

B1=1 ---> Upon switch release, transmit from the user-defined Image release event data. Up to 16 bytes or until a byte value is 00H.

B2=0 ---> No transmission.

B2=1 ---> Upon switch release, transmit from the user-defined switch release event data. Up to 16 bytes or until a byte value is 00H.

B3=0 ---> Disable user-defined Image press repeat.

B3=1 ---> Enable user-defined Image press repeat. Repeatedly transmits user-defined Image release event data upon Image press event in XXH format.

B4 ---> Reserved. Must be set to zero. RS422 only.

B5 ---> Reserved. Must be set to zero. RS422 only.

B6=0 ---> Disable timer for command 26H.

B6=1 ---> Enable timer for command 26H. Controller waits for additional optional bytes until user-defined timer expires. (50ms)

B7=0 ---> Normal operation mode.

B7=1 ---> Continuous command operation mode. Turns the user-defined timer on for two consecutive commands. If the timer expires before the controller receives the next command, blinking red codes are put into the refresh Buffer for all the switches. This is for applications in which the host continuously communicates with the controller. Blinking red indicate to the operator that controller is off line.

9. Controller Set-up, Command 26H

This command is for set-up/testing of the controller. The controller is put into the set-up mode, where any number of options may be transmitted. This is the only command where the timer between two consecutive received bytes is not set. The user must exit this mode by sending X (58H) or ESC (1BH). It is recommended that the B6 of Flag-C to be set during the operation.

Command 26H.

command format: **26H** [Option(s)]

transmit format: (xxH) (xxH)

.....

Option **Read Unit ID**
41H

Controller transmits the unit ID to the host. (Default ID = 41H)

.....

Option **Set Unit ID**
42H [Unit ID (1 byte)]

Controller sets the unit ID to the next byte received.

Option **Red LED Backlighting on**
43H

Controller inserts the red color code into the refresh buffer for all the LED backlighting.

.....

Option **Green LED Backlighting on**
44H

Controller inserts the green color code into the refresh buffer for all the LED backlighting.

.....

Option **Amber LED Backlighting on**
45H

Controller inserts the Amber color code into the refresh buffer for all the LED backlighting.

.....

Option **LED Backlighting Off**
46H

Controller inserts the Off code into the refresh buffer for all the LED backlighting.

.....

Option **Reserved**
47H

Option **Reserved**
48H

Option **Increases LED Brightness Level**
49H

Controller reads the current LED brightness level, increments it and stores its value. The new LED brightness value goes into effect immediately and remains permanently, even after reboot.

Option **Decreases LED Brightness Level**
4AH

Controller reads the current LED brightness level, decrements it and stores its value. The new LED brightness value goes into effect immediately and remains permanently, even after reboot.

Option **Toggle Beeper On/Off**
4DH

Controller toggles the beeper On/Off. The effect lasts for only the duration of the session.

Option **Toggle Switch Closure Beep**
4EH

Controller toggles the flag for audible response to switch closures. The effect lasts for only the duration of the session.

Option **Return Controller to Default State**
4FH

Controller alters the virgin check key memory, so that the subsequent power-up or reset brings the controller to the default stage.

Option **Set Attribute Execution On**
50H

Controller enables the flag for attribute execution. The effect lasts for only the duration of the session.

.....

Option **Set Attribute Execution Off**
51H

Controller disables the flag for attribute execution. The effect lasts for only the duration of the session.

.....

Option **Return Firmware Version**
52H

Controller transmits the firmware Version in ASCII Hex.

Example: (61 20 28 43 31 36 30 31 20 2D 41 20 56 31 2E 30 20 29 79)_{Hex} translates to (C1603-A V1.0)

.....

Option **Serial Set-up Mode**
53H *[serial setup option]*

Controller is put into serial set-up mode. Once in serial set-up mode, only options for serial set-up are available. The mode is not changed until power-up or reset.

31H	Select 9600 BAUD rate
32H	Select 19200 BAUD rate
33H	Select 57600 BAUD rate
49H	Write the selected option to the Ram, transmit 79H and exit command 26H.
53H	Transmit the baud rate to the host: 9600 (20H 39H 36H 30H 30H), 19200 (31H 39H 32H 30H 30H) and 57600 (35H 37H 36H 30H 30H).

Example: (26 53 33 49) sets the baud speed to 57600 upon power-up or reset.

.....

Option **Reserved**
54H

.....

Option **Reserved**
55H

.....

Option **Reserved**
56H

.....

Option **Reserved**
57H

Option **Enable Switch Release Reports**
61H

Controller sets the flag which enables switch release reports. The effect lasts for only the duration of the session.

.....

Option **Disable Switch Release Reports**
62H

Controller sets the flag which disables switch release reports. The effect lasts for only the duration of the session.

.....

Option **Disable Switch Closure Beep**
63H

Controller sets the flag which disables the switch closure beep. The effect lasts for only the duration of the session.

.....

Option **Enable Switch Closure Beep**
64H

Controller sets the flag which enables the switch closure beep. The effect lasts for only the duration of the session.

Option **Turn Beeper Off**
65H

Controller turns beeper off. The effect lasts for only the duration of the session.

Option **Turn Beeper On**
66H

Controller turns beeper on. The effect lasts for only the duration of the session.

Option **Disable Switch Press Reports (Default value)**
67H

Controller sets the flag which disables switch press reports (default value). The effect lasts for only the duration of the session.

Option **Enable Switch Press Reports (Default value)**
68H

Controller sets the flag which enables switch press reports (default value). The effect lasts for only the duration of the session.

Option **Disable Switch Press Reports (User-Defined)**
69H

Controller sets the flag which disables switch press reports (User-Defined). The effect lasts for only the duration of the session.

Option **Enable Switch Press Reports (User-Defined)**
6AH

Controller sets the flag which enables switch press reports (User-Defined). The effect lasts for only the duration of the session.

Option **Disable Image Press Reports (Default value)**

6BH

Controller sets the flag which disables Image press reports (Default value). The effect lasts for only the duration of the session.

Option **Enable Image Press Reports (Default value)**

6CH

Controller sets the flag which enables Image press reports (Default value). The effect lasts for only the duration of the session.

Option **Disable Image Press Reports (User-Defined)**

6DH

Controller sets the flag which disables Image press reports (User-Defined). The effect lasts for only the duration of the session.

Option **Enable Image Press Reports (User-Defined)**

6EH

Controller sets the flag which enables Image press reports (User-Defined). The effect lasts for only the duration of the session.

Option **Exit command 26H**

1BH

Controller transmits 79H and exits command 26H.

Option **Exit command 26H**

58H

Controller transmits 79H and exits command 26H.

.....

Option **Any non-option byte**
XXH

Controller transmits 6EH and exits command 26H.

5. Hardware

WARNING: These products are ESD sensitive. The ESD handling procedure must be followed.

Power Requirement: 1Amp at 9Volts (maximum: 12Volts).

Dimensions

Dimension: Board size: 4.500" x 4.200" (114.3 x 106.68 mm)

Mounting holes: Four

Hole size: .150" (3.81mm)

Distance from edges of the board: .150" (3.81mm)

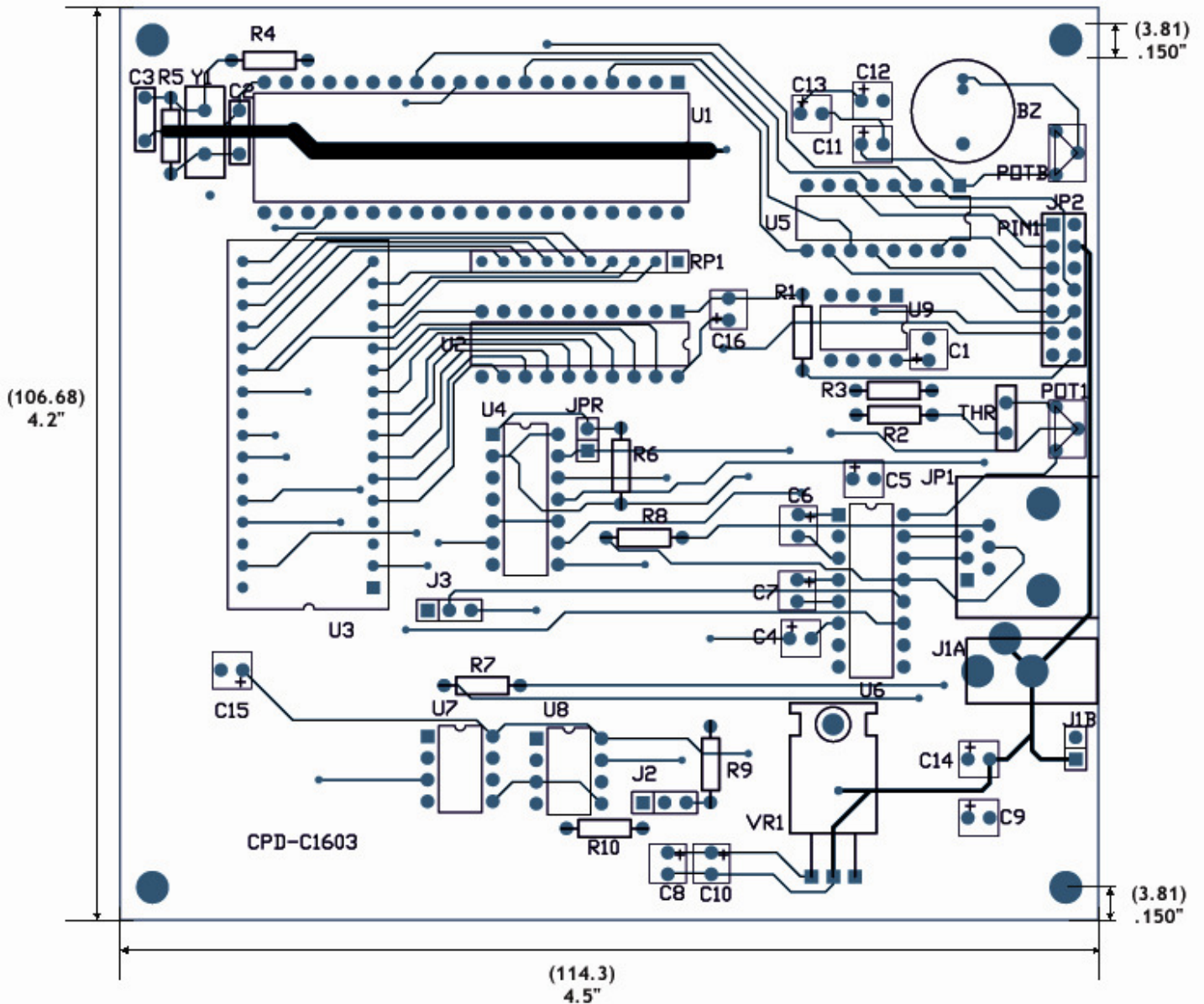

Controls Overview

POTB: Beeper Volume adjusts the volume of the beeper.

JP2: Logic Board Header is the connector for the ribbon cable to the logic boards. Pin numbers much match up from connector to connector using Pin 1 as a guide. 7x2 male header .1"x.1" spacing.

Note: Improper installation of the Logic Boards could damage either/both the Logic Boards and controller.

POT1: LCD viewing angle/contrast adjustment for all the switches.

JP1: RS232/ RS422/RS485 Connector links the controller to the host.

	1	2	3	4	5	6
RS232	GND	TX	RX	GND

	1	2	3	4	5	6
RS422/485	T-	NC	T+	R-	NC	R-

For RS232 U6 is populated with MAX232 and U7 and U8 are not populated. For RS422 U7 and U8 are populated with SN75176 and U6 is not populated. For RS485 only U7 is populated.

J1A: 9V DC Power jack mates with a 2.5mm cylinder power connector. Center positive.

J1B:Alternative power connector: 2 pin header .1" spacing. Pin1 GND , pin2 +9V

Logic Board Header (JP2) pin call outs:

Pin	Function
1	LP
2	GND
3	FLM
4	GND
5	SCP
6	+9V
7	LP1
8	LED OFF
9	SCP
10	VLC
11	DIN
12	+9V
13	DIN
14	SWREAD

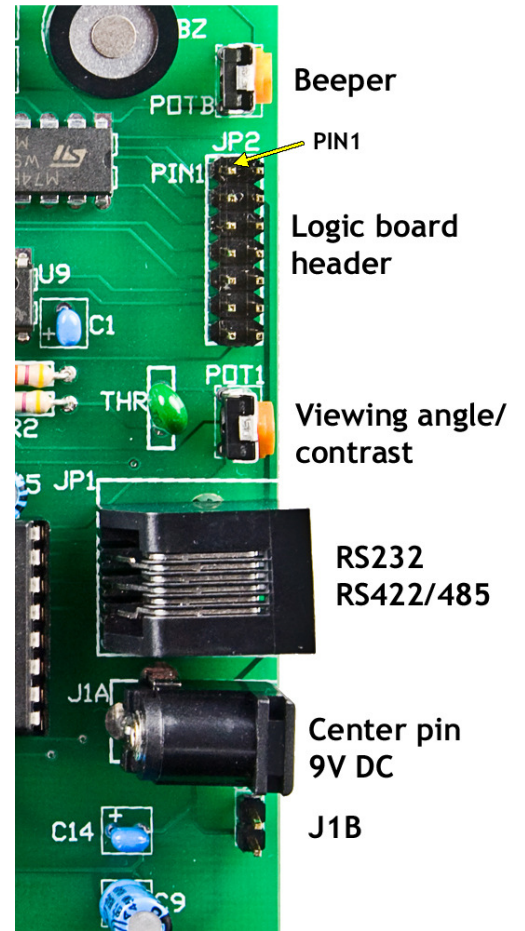

Jumper Overview

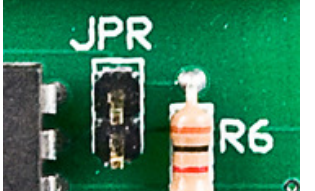
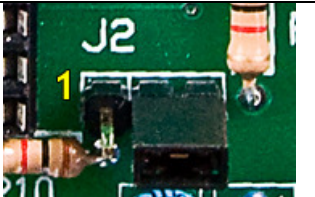
<p>J3: RS232: No jumper RS485: Jumper on pin 1 and pin 2 RS422: Jumper on pin 2 and pin 3 Unnecessary for programming.</p>	
<p>JPR: Used for programming the DS89C450 microcontroller. It should be placed for the duration of programming.</p>	
<p>J2: 4-bit Logic: Jumper on pin 1 and pin 2 2-bit Logic: Jumper on pin 2 and pin 3 Unnecessary for programming.</p>	

Controller Schematic

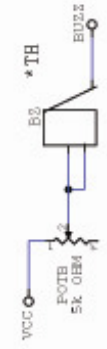
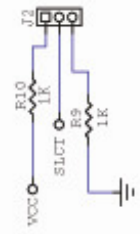
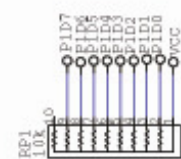
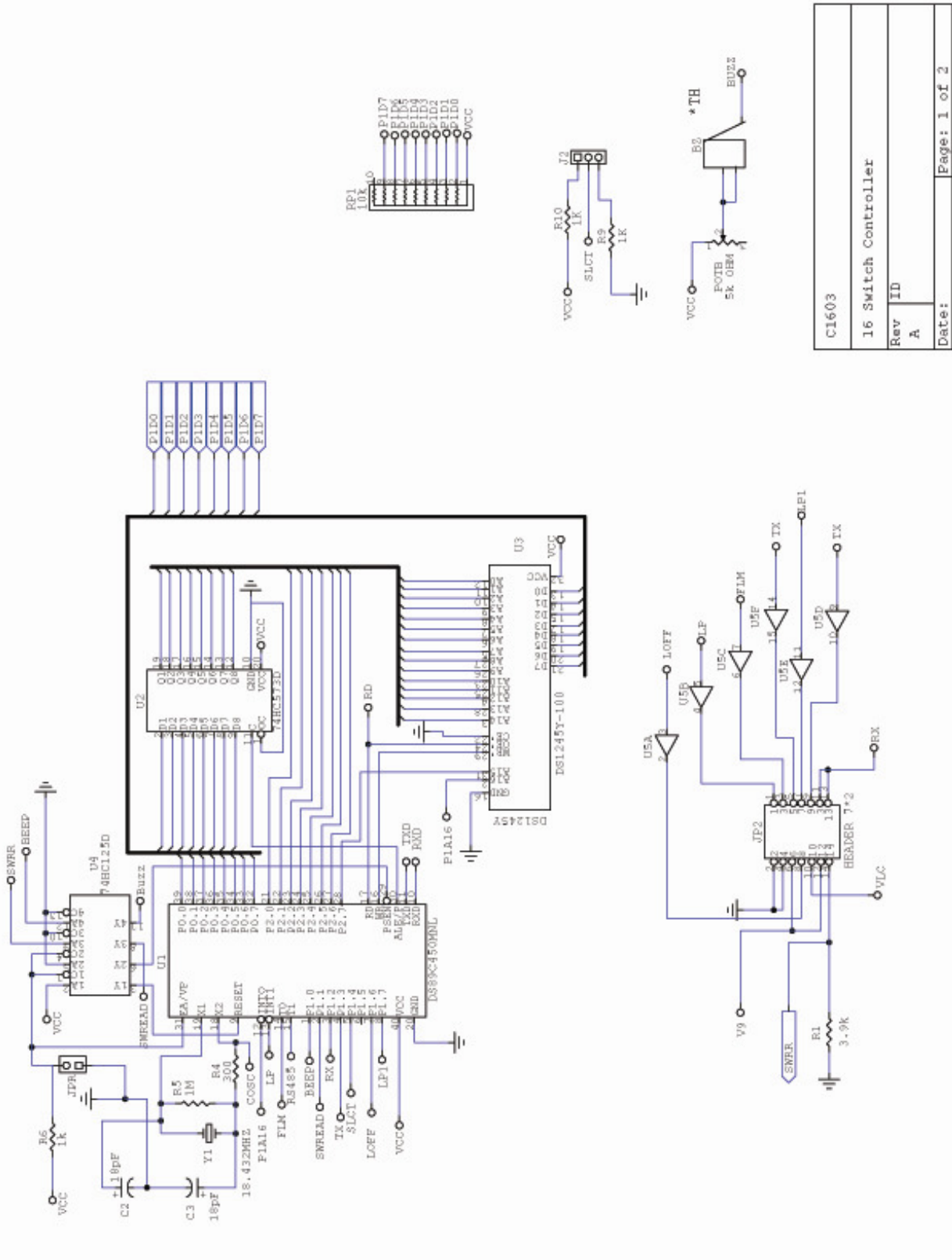

C1603
16 Switch Controller
Rev ID
A
Date:
Page: 1 of 2

Controller Schematic (continued)

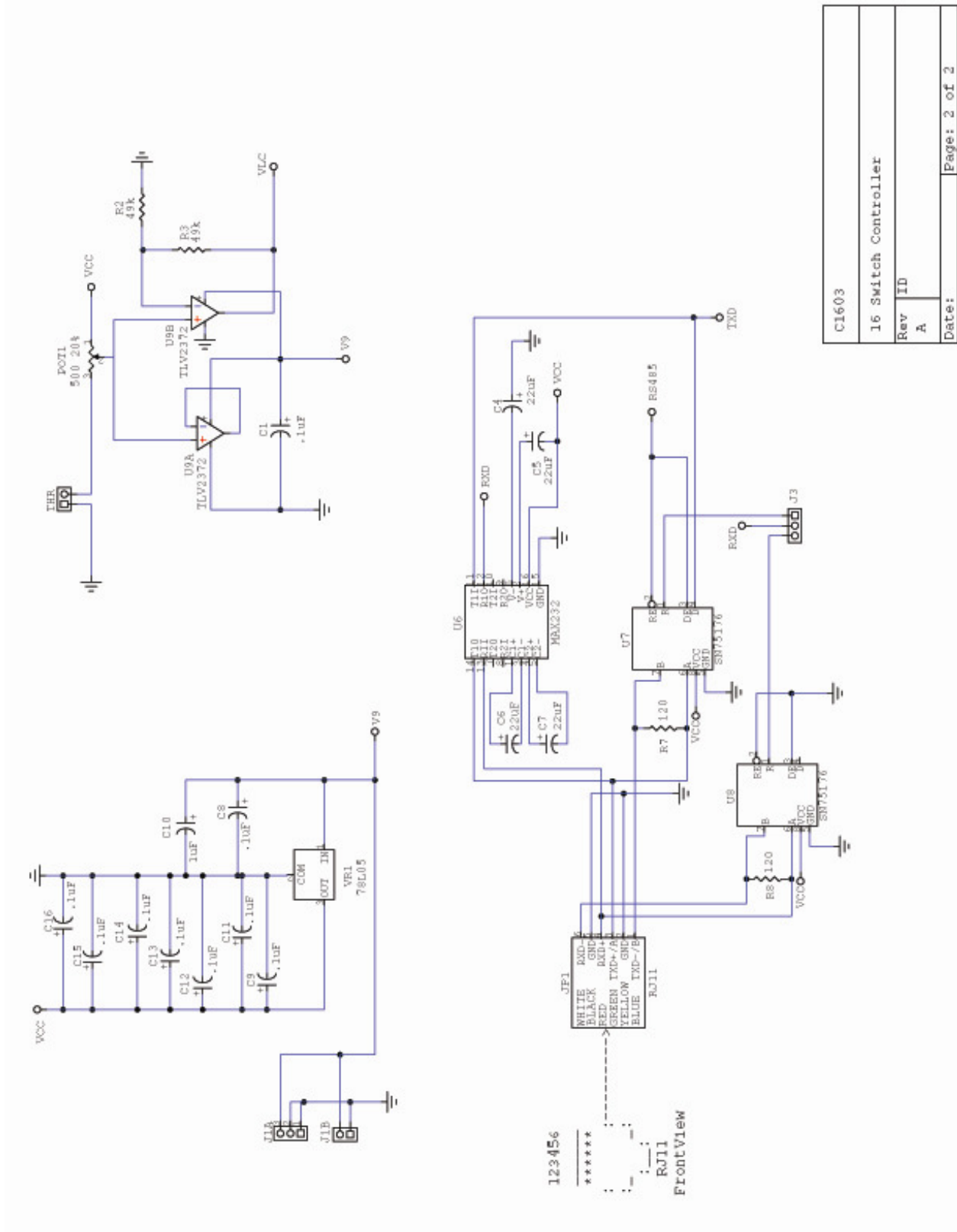

C1603
16 Switch Controller
Rev ID
A
Date:
Page: 2 of 2

Two LCD 36x24 Resolution SmartSwitch, 36X24 RGB, logic board

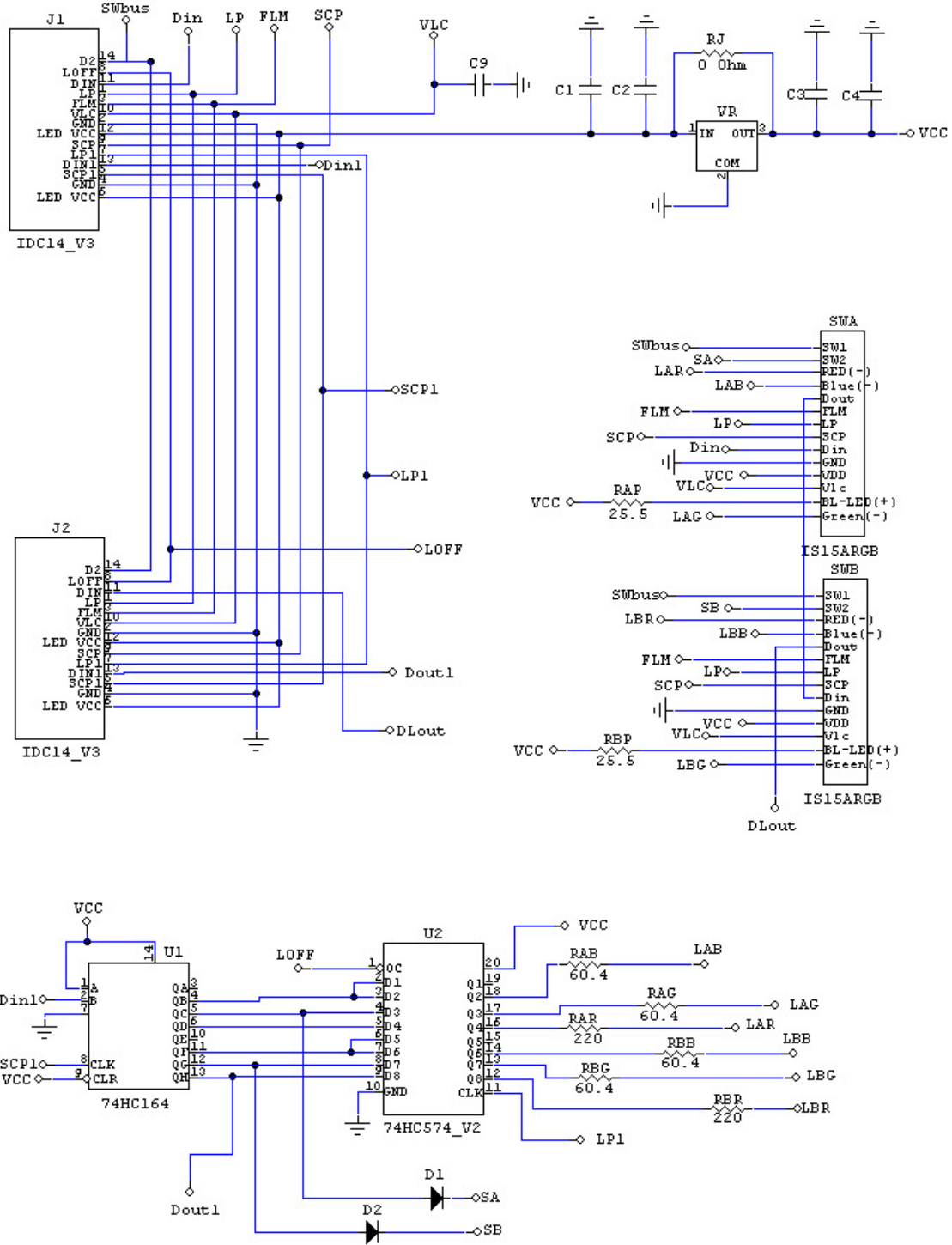

Two LCD 36x24 SmartSwitch, 36X24 bicolor, logic board

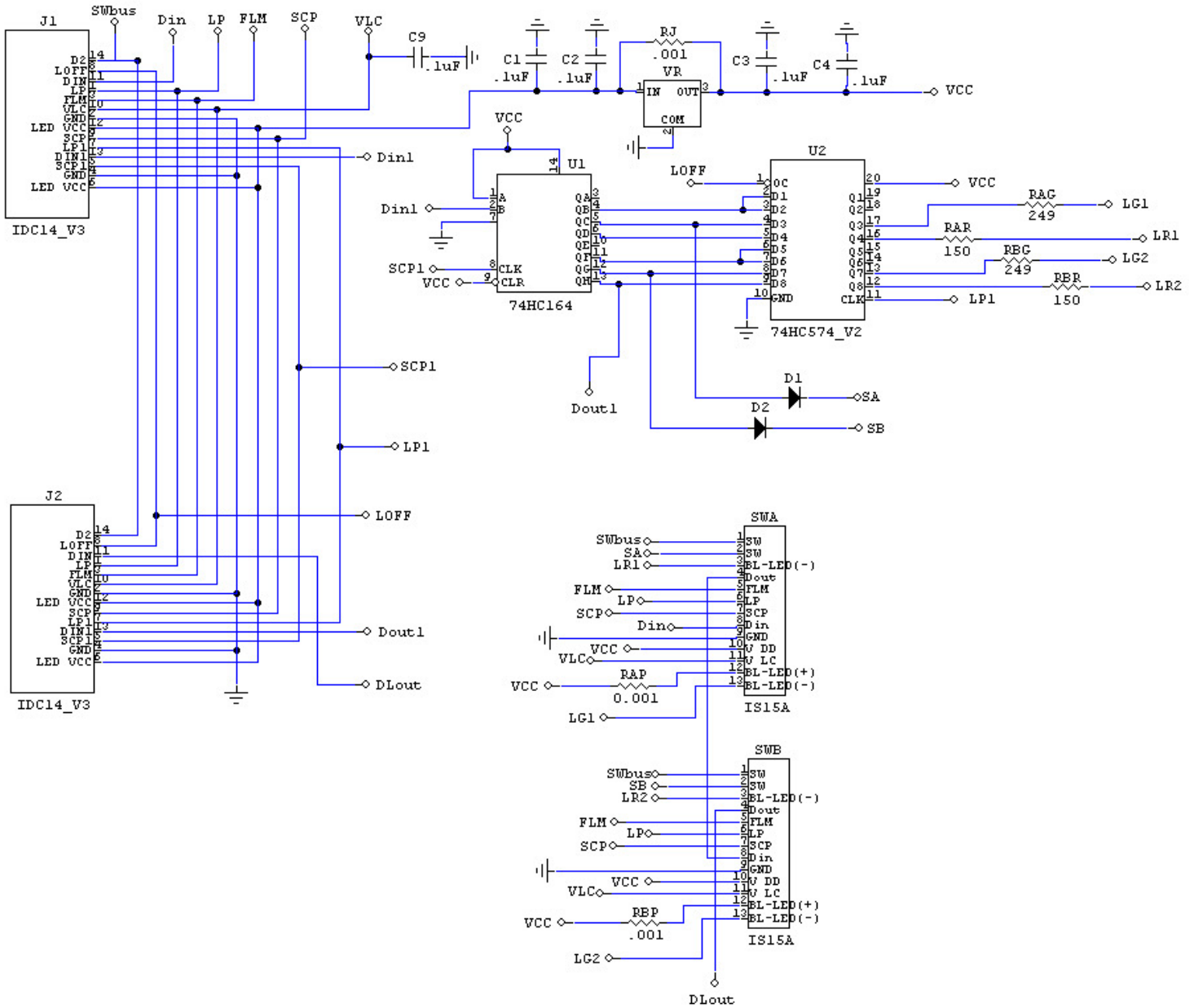

Board photo

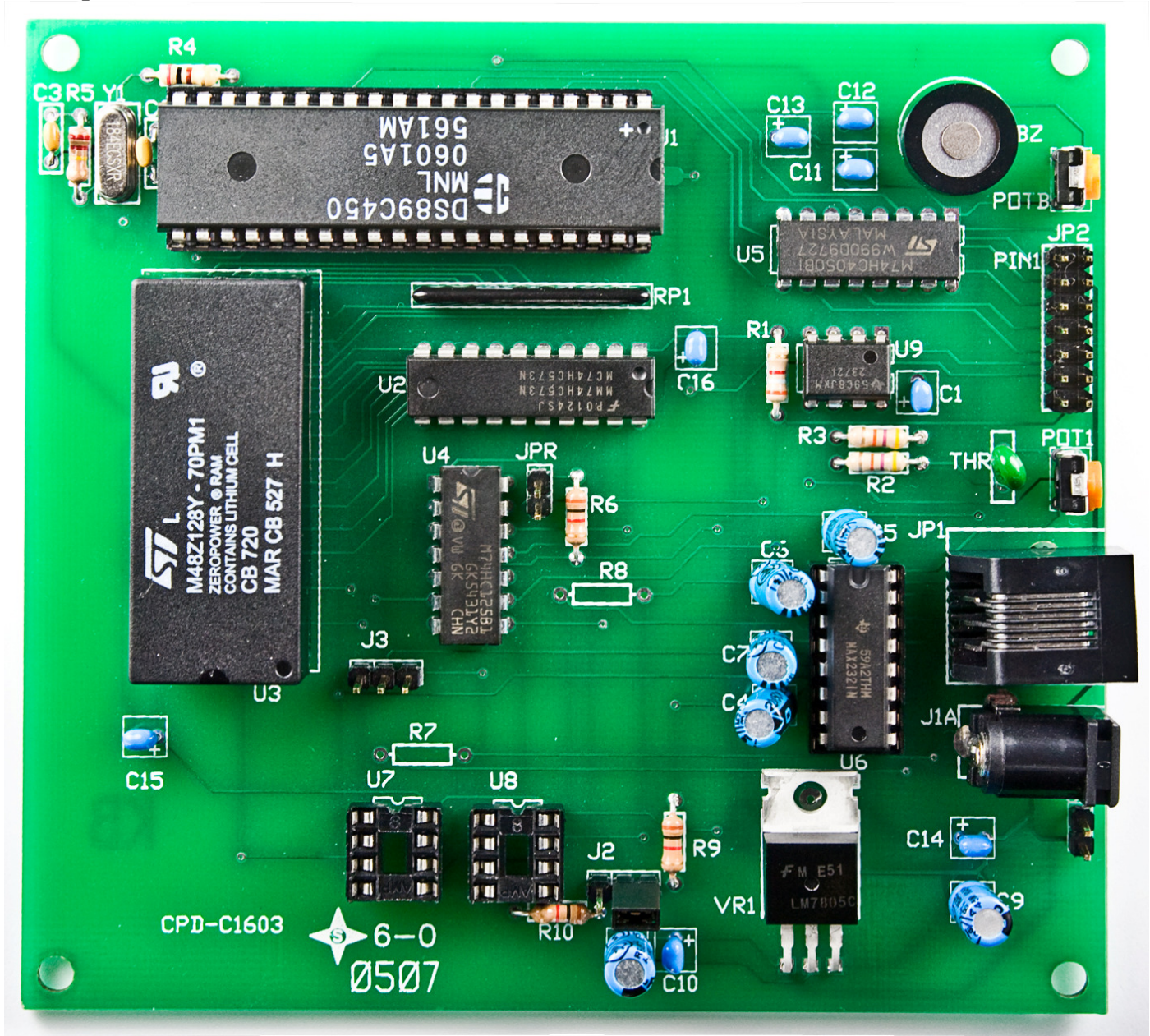

6. Key Terms & Definitions

Module	NKK Switches' LCD SmartSwitches and SmartDisplays. Sometime referred to as switch.
Host	Any computer, terminal, or other device that can communicate over the RS232, RS422, RS485 line.
Controller	A PCB assembly that controls one or more logic boards and the switches associated with them. It communicates with a host over the RS232 line.
Logic Board	A PCB assembly with “glue logic” for mounting switches. It is controlled by a controller.
Byte	An eight bit hex value ranging from 00H to FFH (Decimal 0 to 255). The bit format of a byte is: (B7 B6 B5 B4 B3 B2 B1 B0) where B7 is most significant and bit B0 is least significant bit.
Nibble/Hex digit	A four bit value ranging from 0H to FH. A byte consists of two nibbles.
ASCII	A byte value representing a symbol.
Communication Format	<p>There are two formats to transmit a byte:</p> <ol style="list-style-type: none">Hex format - A hex byte is transmitted without any change to it. [xxH] will be used to denote this. All commands and some data are sent by using this format.ASCII HEX format - Each nibble of the byte is converted to ASCII code and sent as a byte. [xxAH] will be used to denote this. For example, the hex byte 5AH is transmitted in two bytes, 35H and 41H. The ASCII value for 5 is 35H and the ASCII value for A is 41H. All addresses and most data are sent using this format.
Module Number	A one byte value ranging from 01H to 10H. One for each Module.
Pointer	Each module has a pointer. The pointer value is the current address of the module. It is a one byte value ranging from 01H to FFH.
Address	A one byte value ranging from 01H to FFH representing the 255 memory locations.

Page The data at each address. Each Page has image data, LCD/LED data, attribute block data, and user-define picture closure/release data.

7. Programming the Firmware

The controller firmware can be programmed via the RS232 connection.

The Dallas semiconductor MTK software can be downloaded from the site below.

<http://www.maxim-ic.com/products/microcontrollers/software/index.cfm#development>

After you install the MTK software follow the following instructions to program the microcontroller:

1. Disconnect the switches from the controller at JP2.
2. Install a jumper on JPR connector (top right side of the board). This will put the microcontroller into programming mode.
3. Run MTK software.
4. Select device DS89C450.
5. Under menu item “Options” select the “Configure Serial Port” and select relevant port and 19200 baud rate.
6. Under menu item “Target” select “Open COM X at 19200 baud”.
7. Plug in or power up the IS-C1603 controller.
8. Under menu item “Target” select “Connect to Loader”.
9. The microcontroller will respond with a version number and copyright notice in blue.
10. Under menu item “File” select “Load Flash”.
11. Specify the HEX file provided by NKK Switches (e.g. C1603V13.HEX)
12. Once loaded the display shall say “Load Complete”

Note: The switches should not be connected while programming the controller since they are not being refreshed during programming.

8. Firmware Issues

The problems found in the most current version are listed below and will be resolved in the following version.

Version 1.3

1. No firmware issues at this time.

Appendix

Understanding Decimal, Hexadecimal and Binary Numbers

Decimal is the numbering system we use. It is called base-10. Every digit can be between 0 to 9. The value of each digit is equal to the digit with ((Digit order) -1) zero in front.

Table 1, Base-10								
Value in base-10 Digit x				10000	1000	100	10	1
Multiplication for converting to decimal	$10^{(N-1)}$	10^4	10^3	10^2	10^1	10^0
Digit order	Nth digit	Fifth digit	Fourth digit	Third digit	Second digit	First digit

Example: The value of each digit of the Base-10 number 7605 is as follow:

Fourth digit: 7 with (4-1) zero = 7000
 Third digit: 6 with (3-1) zero = 600
 Second digit: 0 with (2-1) zero = 0
 First digit: 5 with (1-1) zero = 5

Numbering system

A numbering system can be based on any number (base-N). However it has to follow the rules:

1. Each digit has to be between 0 to (Base minus one). For example:
 - Each digit for Base-2 numbering system can be 0 or 1
 - Each digit for Base-5 numbering system can be 0 to 4
 - Each digit for base-8 numbering system can be 0 to 7

2. The value of each digit is equal to the digit with ((Digit order) -1) zeros in front.

All the operations that we use on base 10 numbering system such as addition, subtraction, multiplication, division... works the same for all the numbering systems. The difference is the carry over will be based on the base-number of the numbering system instead of 10.

Why do we need other base numbering systems?

Computers logic is based on two states:
 Yes or No
 False or True
 High voltage or low voltage

Base-2 numbering system (binary)

The numbering system to accommodate the computer logic is called binary or base 2. Each digit of binary can be 0 or 1.

Table 2, Base-2								
Value in base-2 Digit x				10000	1000	100	10	1
Multiplication for converting to decimal	$2^{(N-1)}$	$2^4 = 16$	$2^3 = 8$	$2^2 = 4$	$2^1 = 2$	$2^0 = 1$
Digit order	Nth digit	Fifth digit	Fourth digit	Third digit	Second digit	First digit

Example: The value of each digit of the Base-2 number 1010 is as follow:

Fourth digit: 1 with (4-1) zero = 1000
 Third digit: 0 with (3-1) zero = 0
 Second digit: 1 with (2-1) zero = 10
 First digit: 0 with (1-1) zero = 0

To convert a base-2 number to decimal, multiply each digit by multiplier and add them together:

Example: converting base-2 number 1010 to decimal is as follow:
 $(1 \times 8) + (0 \times 4) + (1 \times 2) + (0 \times 1) = 10$

To convert a decimal number to base-2 number

- divide the decimal number by 2, the remainder is the first digit of the base-2 number
- continue dividing quotient by 2 and put the remainder as the next digit until the quotient is equal 0.

Example: Convert the decimal number 21 to base-2

21 divide by 2 = 10 with 1 remainder	First digit = 1
10 divide by 2 = 5 with 0 remainder	Second digit = 0
5 divide by 2 = 2 with 1 remainder	Third digit = 1
2 divide by 2 = 1 with 0 remainder	Fourth digit = 0
1 divide by 2 = 0 with 1 remainder	Fifth digit = 1

21 decimal = 101001 base-2 or binary
 The base-2 number 101001 reads as one zero one zero zero one.

Base-16 numbering system

Communicating base-2 numbers is difficult for human because of all zero's and one's. To make it easier to present computer data, hexadecimal or base-16 numbering system is used. Four digit of base-2 numbering system convert to one digit of base-16 numbering system. Since we did not have digits for 10, 11, 12, 13, 14 and 15, they were assigned letters A, B, C, D, E and F respectively.

Hexadecimal base-16	Decimal base-10	Binary base-2
0	0	0
1	1	1
2	2	10
3	3	11
4	4	100
5	5	101
6	6	110
7	7	111
8	8	1000
9	9	1001
A	10	1010
B	11	1011
C	12	1100
D	13	1101
E	14	1110
F	15	1111
10	16	10000
11	17	10001
etc	etc	etc

Value in base-16 Digit x				10000	1000	100	10	1
Multiplication for converting to decimal	$16^{(N-1)}$	16^4 =65536	16^3 =4096	16^2 =256	16^1 =16	$16^0=1$
Digit order	Nth digit	Fifth digit	Fourth digit	Third digit	Second digit	First digit

Example: Convert 2A7 hex to decimal

$$\begin{array}{r}
 \text{Digit 3: } 2 \times 256 = 512 \\
 \text{Digit 2: } (10) \times 16 = 160 \\
 \text{Digit 1: } 7 \times 1 = 7 \\
 \hline
 679
 \end{array}$$

2A7 hex = 679 decimal

Example: Convert 925 decimal to hex

925 divide by 16 = 57 with 13 remainder	First digit = D
57 divide by 16 = 3 with 9 remainder	Second digit = 9
3 divide by 16 = 0 with 3 remainder	Third digit = 3

925 decimal = 39D hex

Converting between hex and binary is as easy as replacing each digit of hex with equivalent 4 digit of binary.

Example: convert A5B hex to binary

$$\begin{array}{l}
 A = 1010 \\
 5 = 0101 \\
 B = 1011
 \end{array}$$

A5B hex = 1010 0101 1011 binary

Converting binary to hex is as easy as replacing each 4 digit of binary to equivalent digit of hex. If the binary digits are not multiple of 4 for grouping, add enough zero to the left to make them multiple of 4.

Example: Convert 0111 1010 1111 binary to hex

$$\begin{array}{l}
 1111 = F \\
 1010 = A \\
 0111 = 7 \\
 0111 1010 1111 \text{ binary} = 7AF \text{ hex}
 \end{array}$$

Common terms:

- Bit = binary digit
- Nibble = 4 binary digits
- Byte = 8 binary digits = 2 nibbles = 2 HEX digits