

---

## Designated client product

This product will be discontinued its production in the near term.  
And it is provided for customers currently in use only, with a time limit.  
It can not be available for your new project. Please select other new or existing products.

For more information, please contact our sales office in your region.

New Japan Radio Co.,Ltd.

[www.njr.com](http://www.njr.com)

## DUAL VIDEO 6dB AMPLIFIER WITH 75Ω DRIVER

### ■ GENERAL DESCRIPTION

**NJM2267** is a dual video 6dB amplifier with 75Ω drivers for S-VHS VCRs, HI-BAND VCRs, etc. Each channel has clamp function that fixes DC level of video signal and 75Ω drivers to be connected to TV monitors directly. Further more it has sag corrective circuits that prevent the generation of sag with smaller capacitance than ever.

Its operating supply voltage is 4.85 to 9V and bandwidth is 7MHz.

### ■ FEATURES

- Wide Operating Voltage (4.85V to 9.0V)
- Dual Channel
- Internal Clamp Function
- Internal Driver Circuit For 75Ω Load
- SAG Corrective Function
- Wide Frequency Range (7MHz)
- Low Operating Current 14.0mA (Dual)
- Package Outline DIP8, DMP8, SSOP8
- Bipolar Technology

### ■ APPLICATIONS

- VCR, Video Camera, TV, Video Disc Player.

### ■ BLOCK DIAGRAM

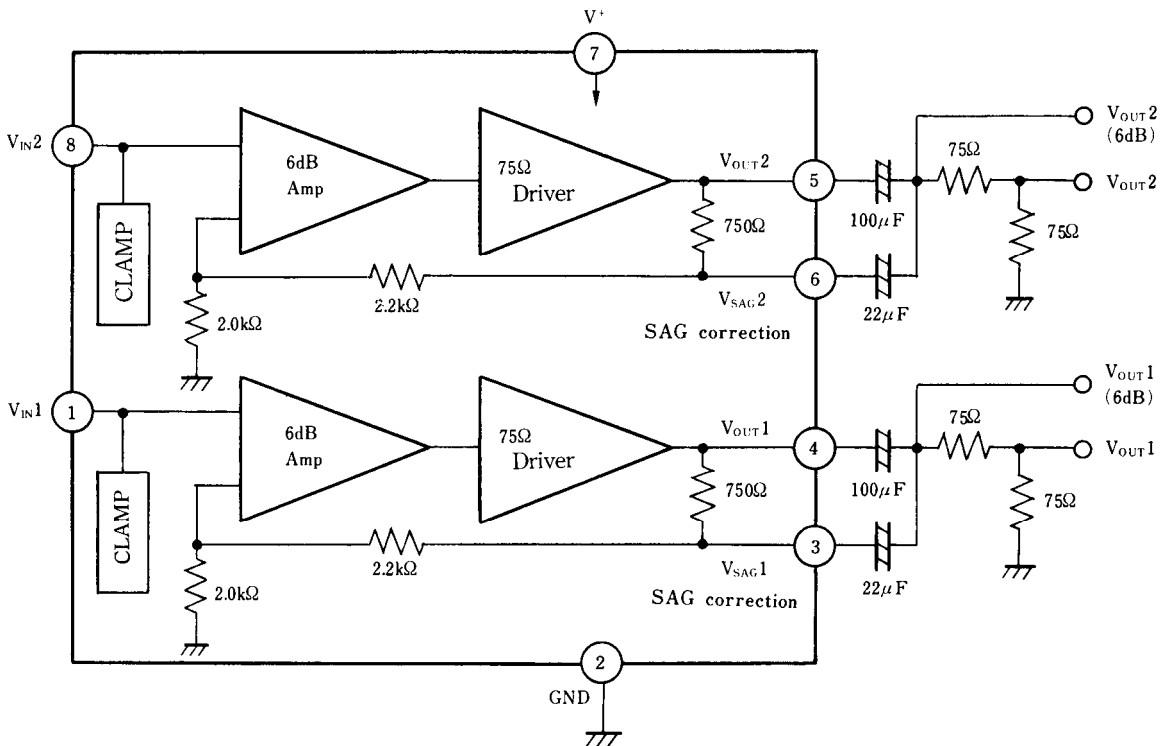

### ■ PACKAGE OUTLINE

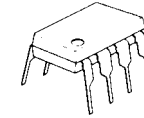

**NJM2267D**

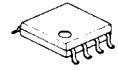

**NJM2267M**



**NJM2267V**

# NJM2267

## ■ ABSOLUTE MAXIMUM RATINGS

(Ta=25°C)

PARAMETER	SYMBOL	RATINGS	UNIT
Supply Voltage	V <sup>+</sup>	10	V
Power Dissipation	P <sub>D</sub>	(DIP8) 500 (DMP8) 300 (SSOP8) 250	mW mW mW
Operating Temperature Range	T <sub>opr</sub>	-40 to +85	°C
Storage Temperature Range	T <sub>stg</sub>	-40 to +125	°C

## ■ ELECTRICAL CHARACTERISTICS

(V<sup>+</sup>=5V, Ta=25±2°C)

PARAMETER	SYMBOL	TEST CONDITION	MIN.	TYP.	MAX.	UNIT
Operating Current	I <sub>CC</sub>	No Signal	-	14.0	18.2	mA
Voltage Gain	G <sub>V</sub>	V <sub>IN</sub> =1MHz, 1V <sub>P-P</sub> Sinewave	5.7	6.2	6.7	dB
Frequency Characteristics	G <sub>f</sub>	V <sub>IN</sub> =1V <sub>P-P</sub> , Sinewave, 7MHz / 1MHz	-	-	±1.0	dB
Differential Gain	DG	V <sub>IN</sub> =1V <sub>P-P</sub> , Staircase	-	1.0	3.0	%
Differential Phase	DP	V <sub>IN</sub> =1V <sub>P-P</sub> , Staircase	-	1.0	3.0	deg
Crosstalk	CT	V <sub>IN</sub> =4.43MHz, 1V <sub>P-P</sub> , Sinewave	-	-70	-	dB
Gain Offset	G <sub>CH</sub>	V <sub>IN</sub> =1MHz, 1V <sub>P-P</sub> , G <sub>CH</sub> =V <sub>OUT1</sub> -V <sub>OUT2</sub>	-	-	±0.5	dB
Input Clamp Voltage	V <sub>CL</sub>		1.79	1.91	2.03	V
SAG Terminal Gain	G <sub>SAG</sub>		35	45	-	dB

## ■ APPLICATION

### Oscillation Prevention

It is much effective to insert LPF (Cutoff Frequency 70MHz) under light loading conditions (R<sub>L</sub> » 1kΩ)

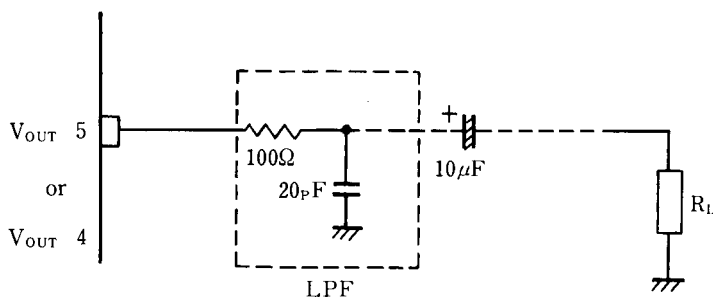

## ■ TERMINAL FUNCTION

( $V^+=5.0V$ ,  $T_a=25^\circ C$ )

PIN No.	PIN NAME	SYMBOL	EQUIVALENT CIRCUIT	FUNCTIONS
1	Input Clamp Terminal	$V_{IN1}$		Input terminal of $1V_{P-P}$ composite signal or Y signal. Clamp level is 1.9V
2	GND	GND		Ground
3	SAG correction	$V_{SAG1}$		SAG caused by a coupling capacitor of the output can be prevented by connecting this terminal with the output terminal through an external capacitor.(see block diagram) When SAG correcting function is not necessary, this terminal must be connected with pin "4" directly.
4	Video Output1	$V_{OUT1}$		Output terminal that can drive 75Ω line.
5	Video Output2	$V_{OUT2}$		Output terminal that can drive 75Ω line.
6	SAG correction	$V_{SAG2}$		SAG caused by a coupling capacitor of the output can be prevented by connecting this terminal with the output terminal through an external capacitor.(see block diagram) When SAG correcting function is not necessary, this terminal must be connected with pin "5" directly.
7	$V^+$	$V^+$		Supply Voltage
8	Input Clamp Terminal	$V_{IN2}$		Input terminal of $1V_{P-P}$ composite signal or Y signal. Clamp level is 1.9V

# NJM2267

## TEST CIRCUIT

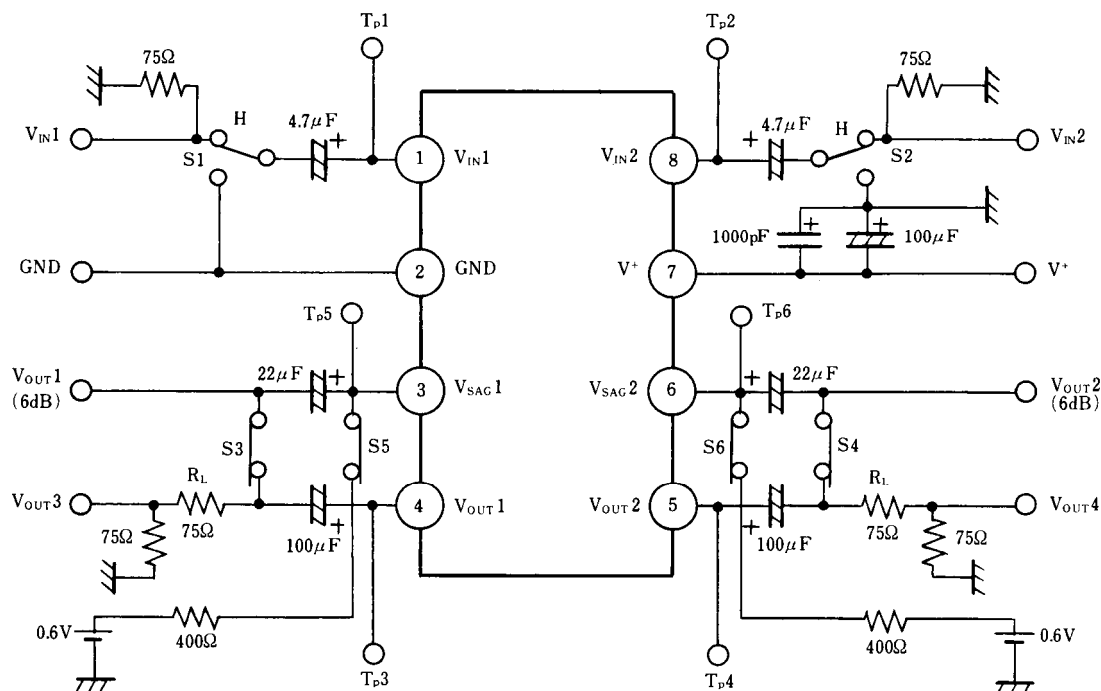

## TEST METHODES

PARAMETER	SYMBOL	SWITCH CONDITIONS						CONDITIONS
		S1	S2	S3	S4	S5	S6	
Supply Current	$I_{CC}$	H	H					7PIN Sink Current
Voltage Gain	$G_V$	H	H	ON	ON			$V_{OUT1} / V_{IN1}$ , $V_{OUT2} / V_{IN2}$ at $V_{IN1}(V_{IN2})=1\text{MHz}$ , $1V_{P-P}$ , Sinewave
Frequency Characteristic	$G_f$	H	H	ON	ON			$G_{V1M}$ : Voltage Gain at $V_{IN1}(V_{IN2})=1\text{MHz}$ , $1V_{P-P}$ $G_{V10M}$ : Voltage Gain at $V_{IN1}(V_{IN2})=7\text{MHz}$ , $1V_{P-P}$ $G_f = G_{V10M} - G_{V1M}$
Differential Gain	DG	H	H	ON	ON			Measuring $V_{OUT3}$ at $V_{IN1}=\text{Staircase Signal}$
Differential Phase	DP	H	H	ON	ON			Measuring $V_{OUT3}$ at $V_{IN1}=\text{Staircase Signal}$
Crosstalk	CT	H	L	ON	ON			$V_{OUT2} / V_{OUT1}$ at $V_{IN1}=4.43\text{MHz}$ , $1V_{P-P}$ , Sinewave $V_{OUT1} / V_{IN2}$ at $V_{IN2}=4.43\text{MHz}$ , $1V_{P-P}$ , Sinewave
Gain Offset	$G_{CH}$	H	H	ON	ON			$G_{V1} = V_{OUT1} / V_{IN1}$ , $G_{V2} = V_{OUT2} / V_{IN2}$ $G_{CH} = G_{V1} - G_{V2}$
Input Clamp Voltage	$V_{CL}$	H	H					Measuring at TP1 (TP2)
SAG Terminal Gain	$G_{SAG}$	H	H					TP3 (TP4) Voltage; $V_{o1A}$ ( $V_{o2A}$ ), TP5 (TP6) voltage; $V_{so1A}$ ( $V_{so2A}$ )
		H	H			ON	ON	TP3 (TP4) Voltage; $V_{o1B}$ ( $V_{o2B}$ ), TP5 (TP6) voltage; $V_{so1B}$ ( $V_{so2B}$ ) $G_{SAG} = 20 \log \{ (V_{o1B} - V_{o1A}) / (V_{so1A} - V_{so1B}) \}$ $G_{SAG} = 20 \log \{ (V_{o2B} - V_{o2A}) / (V_{so2A} - V_{so2B}) \}$

◆ **Clamp circuit**

**1. Operation of Sync-tip-clamp**

Input circuit will be explained. Sync-tip clamp circuit (below the clamp circuit) operates to keep a sync tip of the minimum potential of the video signal. Clamp circuit is a circuit of the capacitor charging and discharging of the external input  $C_{in}$ . It is charged to the capacitor to the external input  $C_{in}$  at sync tip of the video signal. Therefore, the potential of the sync tip is fixed.

And it is discharged charge by capacitor  $C_{in}$  at period other than the video signal sync tip. This is due to a small discharge current to the IC.

In this way, this clamp circuit is fixed sync tip of video signal to a constant potential from charging of  $C_{in}$  and discharging of  $C_{in}$  at every one horizontal period of the video signal.

The minute current be discharged an electrical charge from the input capacitor at the period other than the sync tip of video signals. Decrease of voltage on discharge is dependent on the size of the input capacitor  $C_{in}$ .

If you decrease the value of the input capacitor, will cause distortion, called the H sag. Therefore, the input capacitor recommend on more than 0.1 $\mu$ F.

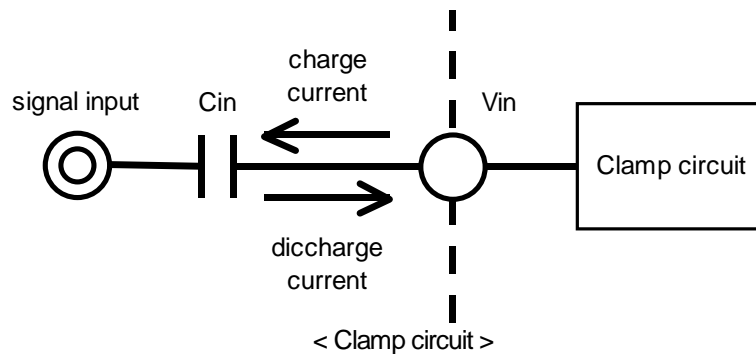

A.  $C_{in}$  is large

B.  $C_{in}$  is small (H sag experience)

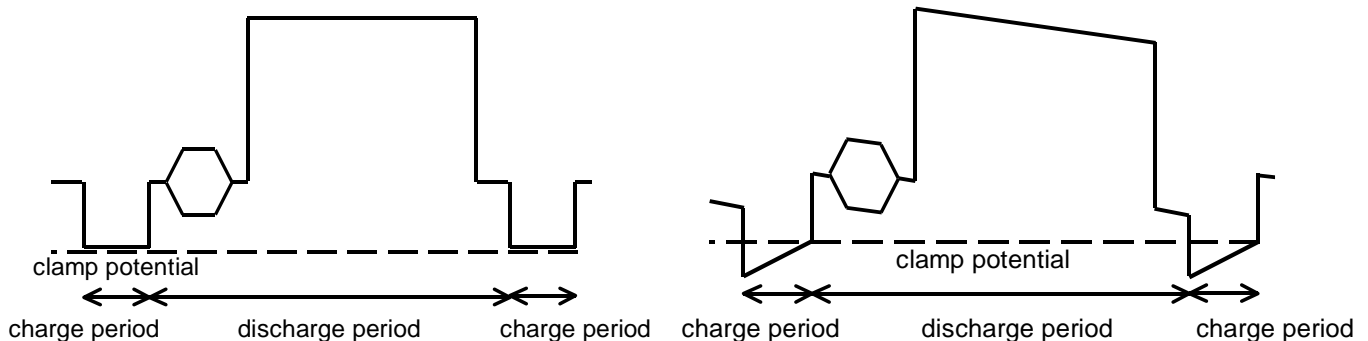

< Waveform of input terminal >

**2. Input impedance**

The input impedance of the clamp circuit is different at the capacitor discharge period and the charge period.

The input impedance of the charging period is a few  $k\Omega$ . On the other hand, the input impedance of the discharge period is several  $M\Omega$ . Because is a small discharge-current through to the IC.

Thus the input impedance will vary depending on the operating state of the clamp circuit.

**3. Impedance of signal source**

Source impedance to the input terminal, please lower than 200 $\Omega$ . A high source impedance, the signal may be distorted. If so, please to connect a buffer for impedance conversion.

## ◆ SAG correction circuit

SAG correction circuit is a circuit to correct for low-frequency attenuation by high-pass filter consisting of the output coupling capacitance and load resistance. Low-frequency attenuation raises the sag in the vertical period of the video signal.

Capacitor for Vsag (Csag) is connected to the negative feedback of the amplifier. This Csag increase the low frequency gain to correct for the attenuation of low frequency gain.

Example SAG collection circuit

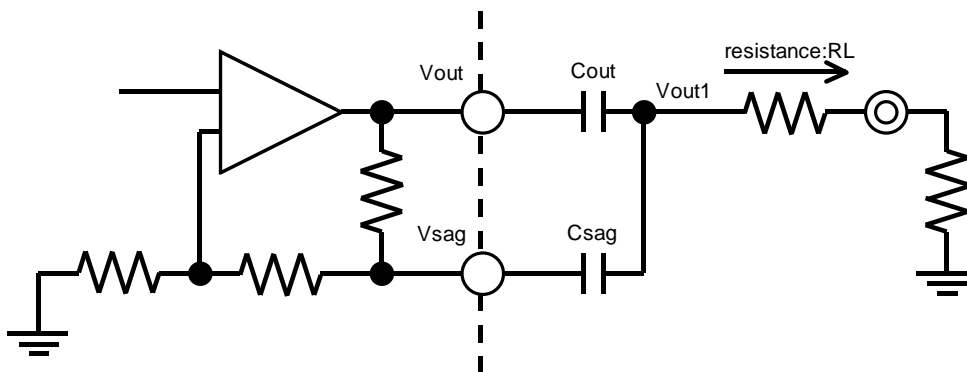

Example of not using sag compensation circuit

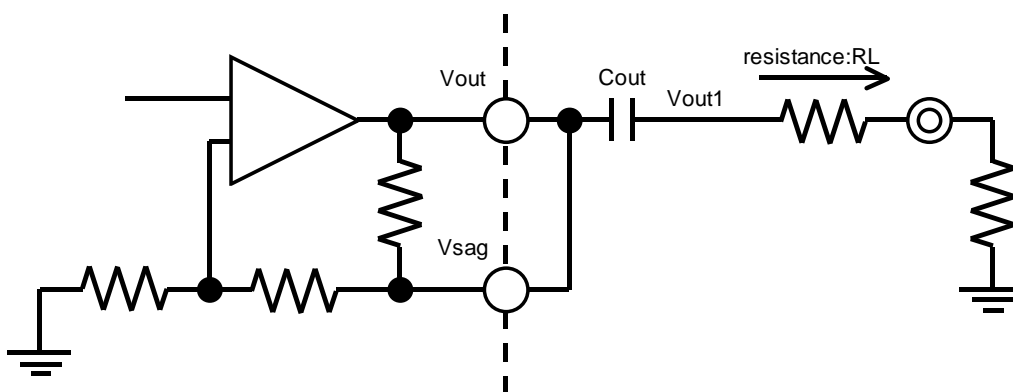

Waveform of Vout terminal and Vout1 terminal

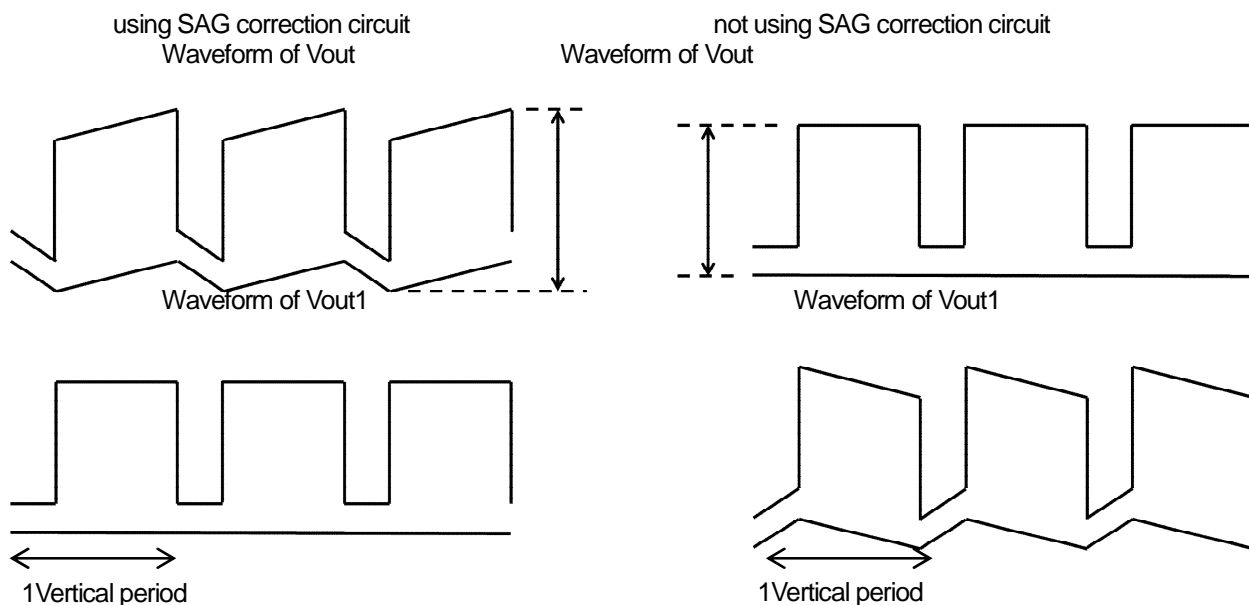

SAG correction circuit generates a low frequency component signal amplified to Vout terminal. Changes of the luminance signal will be low-frequency components, if you want to output a large signal luminance changes. Therefore, generate correction signal of change of a luminance signal to Vout pin.

At this time, signal is over the dynamic range of Vout pin. This may cause a lack of sync signal, and waveform distortion.

Please see diagram below (green waveform), if you want to output large changes of a signal luminance, such as 100% white video signal and black signal. Thus, output signal exceed dynamic range of Vout pin and may be the signal lack.

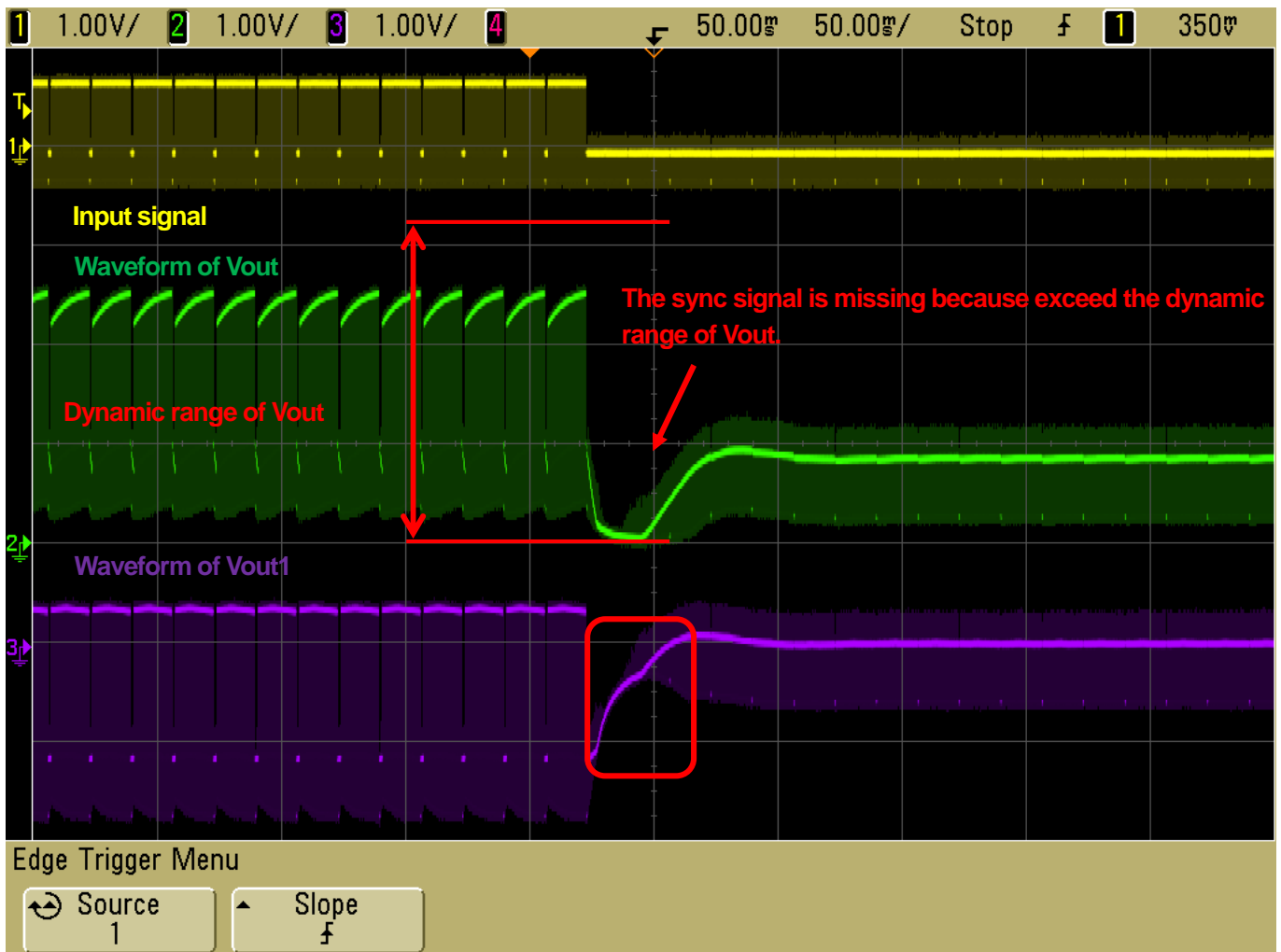

< Countermeasure for waveform distortion >

1. Please using small value the Sag compensation capacitor (CSAG).  
It can ensure the dynamic range by using small value the capacitor (CSAG). It because of low-frequency variation of Vout pin is smaller. However, the output (COUT) must be use large capacitor for this reason sag characteristics become exacerbated.
2. Please do not use the sag correction circuit.  
Signal can output within dynamic range for reason it does not change the DC level of the output terminal.  
However, the output (COUT) must be use large capacitor for this reason sag characteristics become exacerbated.
3. To increase the power supply voltage  
Internal reference voltage is dividing the power supply voltage and GND.  
Therefore, it can ensure the dynamic range by increasing the power supply voltage.



# NJM2267

< Using SAG correction circuit >

Csag=10uF, Input signal: bounce signal (IRE0%, IRE100%, 30Hz), resistance=150Ω

Waveform: yellow: input signal, green: Vout signal, purple: Vout1 signa, red: clip length of waveform

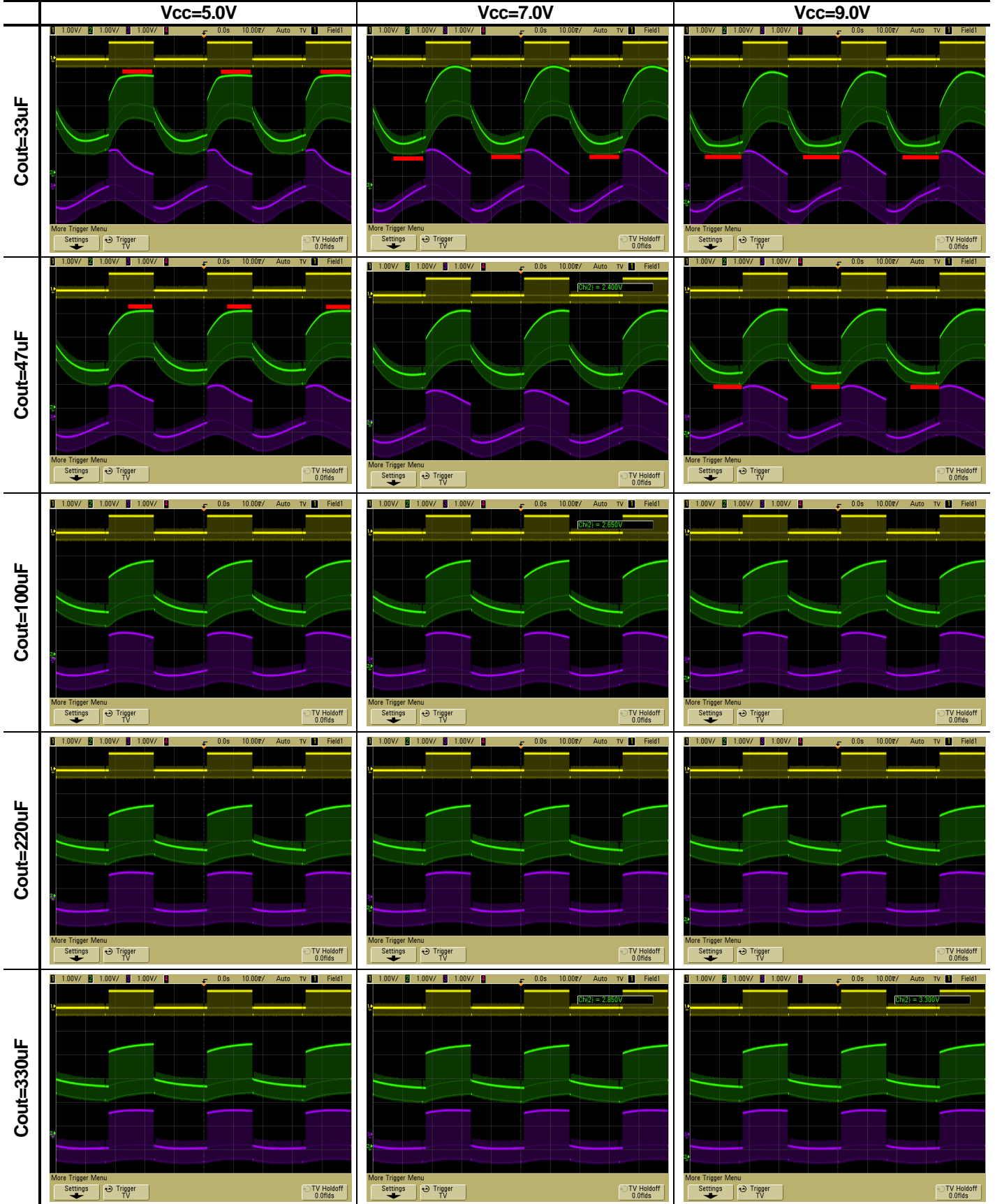

< Using SAG correction circuit >

Csag=22uF, Input signal: bounce signal (IRE0%, IRE100%, 30Hz), resistance=150Ω

Waveform: yellow: input signal, green: Vout signal, purple: Vout1 signa, red: clip length of waveform

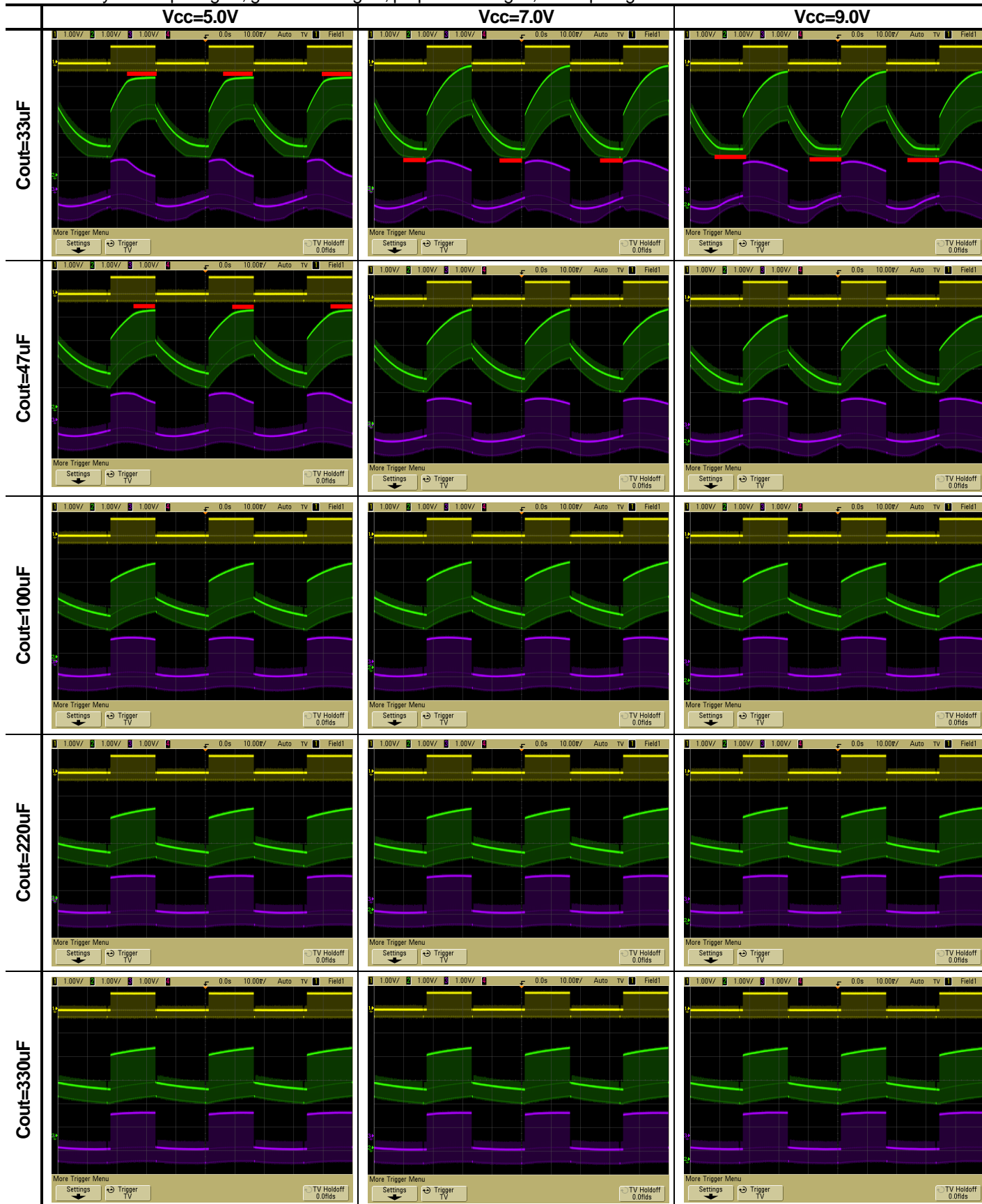

# NJM2267

< Using SAG correction circuit >

Csag=33uF, Input signal: bounce signal (IRE0%, IRE100%, 30Hz), resistance=150Ω

Waveform: yellow: input signal, green: Vout signal, purple: Vout1 signa, red: clip length of waveform

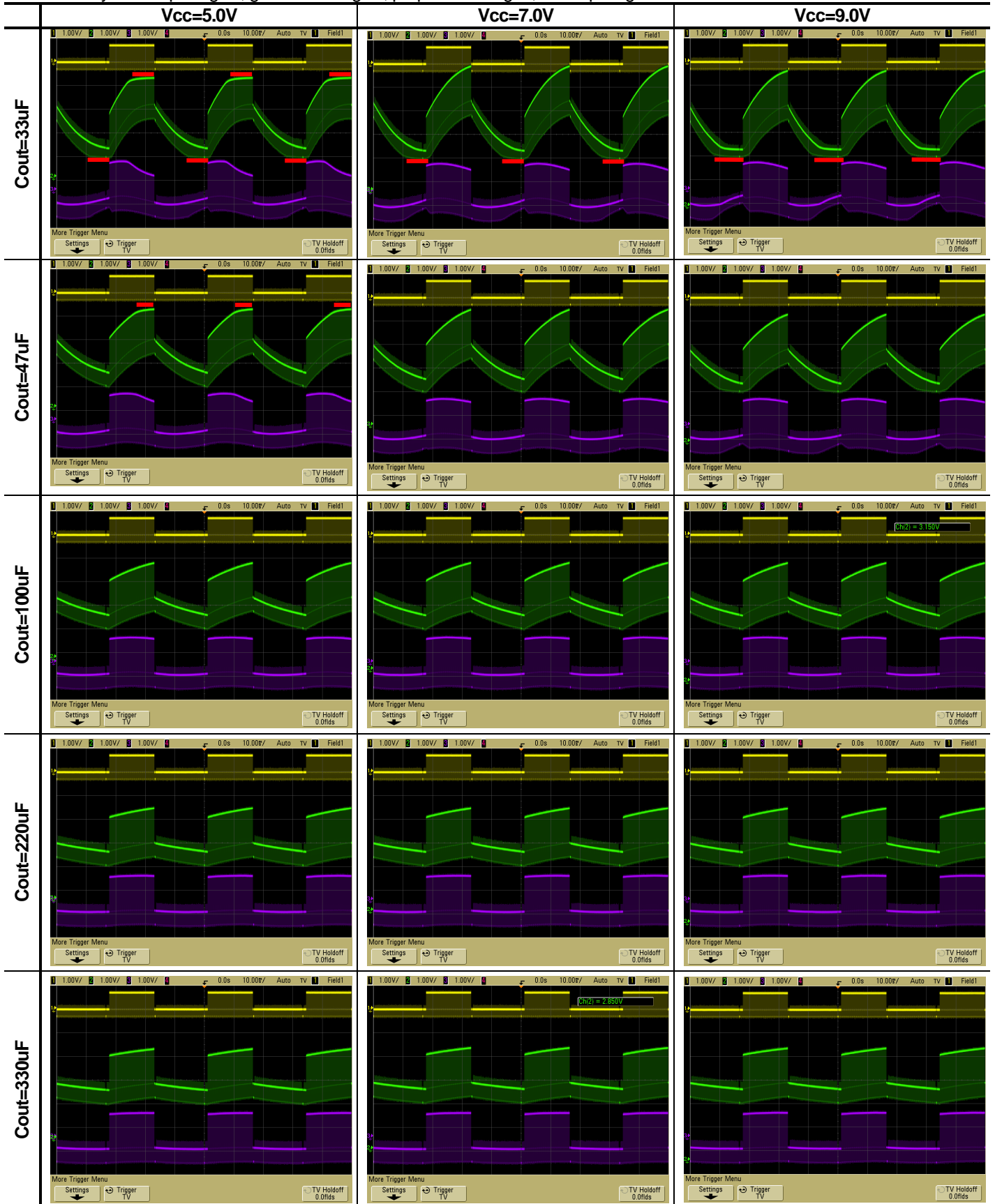

< Using SAG correction circuit >

Csag=10uF, Input signal: Black to White 100%, resistance 150Ω

Waveform: yellow: input signal, green: Vout signal, purple: Vout1 signal, red: clip length of waveform

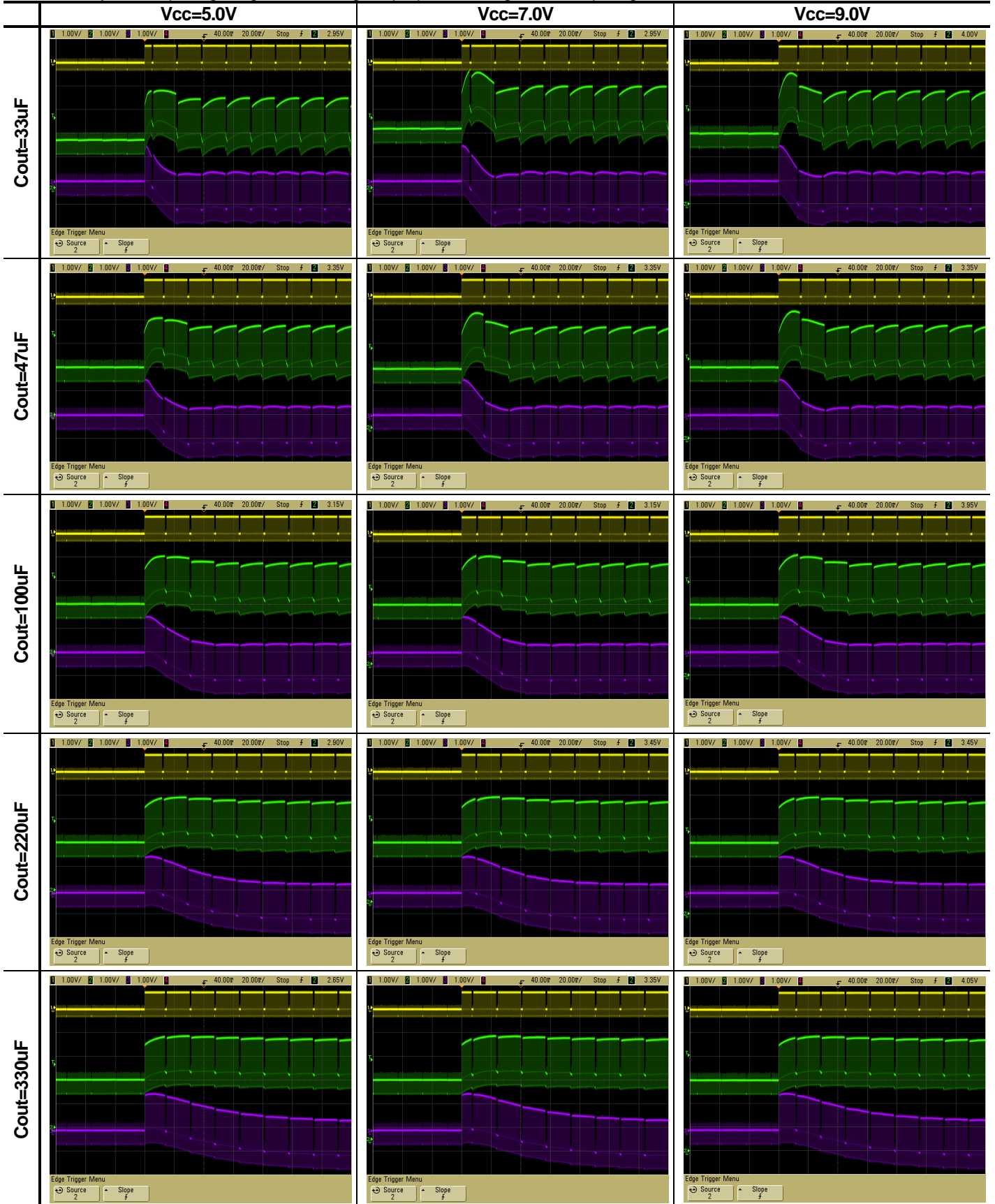

# NJM2267

< Using SAG correction circuit >

Csag=10uF, Input signal: White100% to Black, resistance150Ω

Waveform: yellow: input signal, green: Vout signal, purple: Vout1 signal, red: clip length of waveform

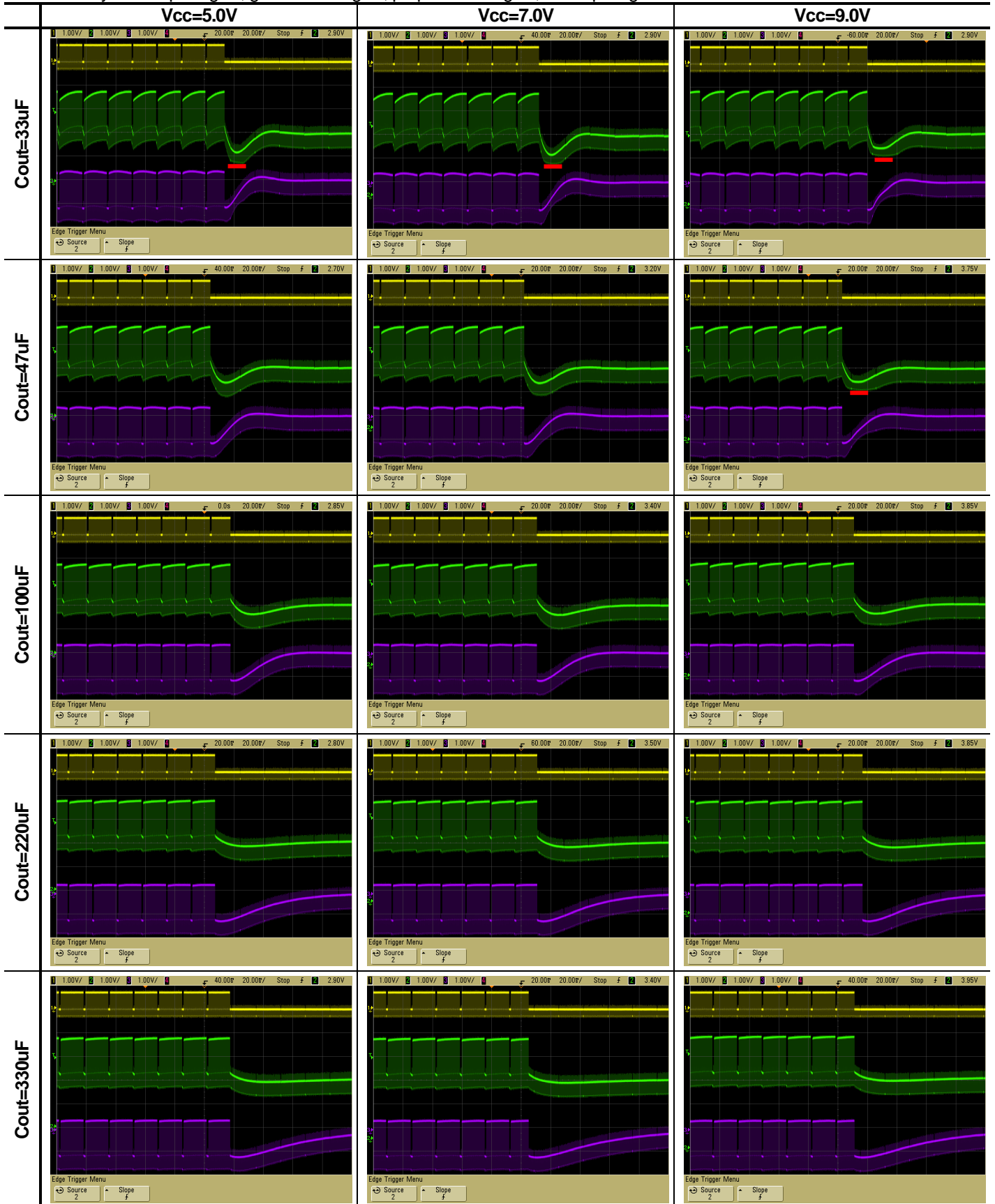

< Using SAG correction circuit >

Csag=22uF, Input signal: Black to White100%, resistance150Ω

Waveform: yellow: input signal, green: Vout signal, purple: Vout1 signal, red: clip length of waveform

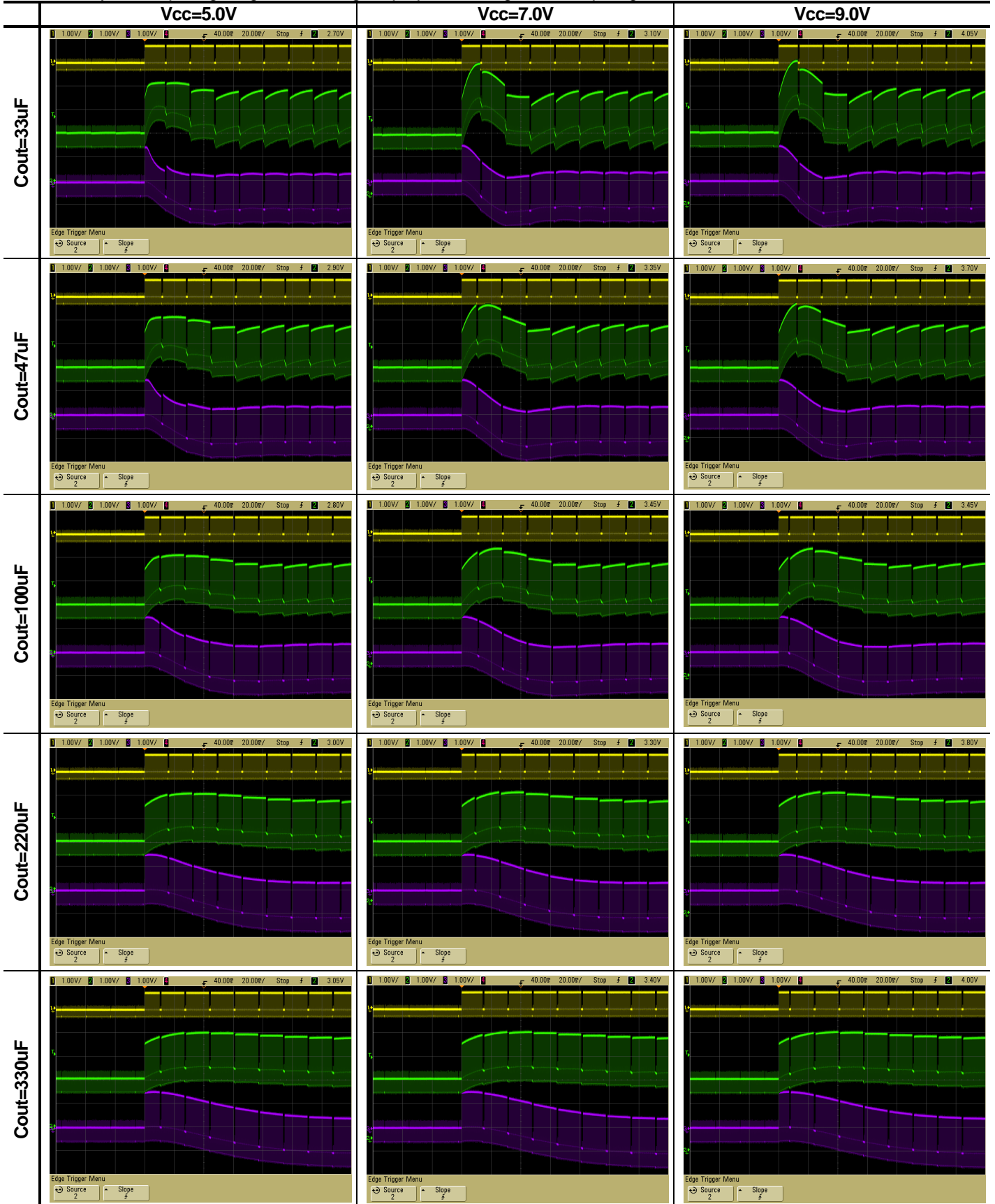

# NJM2267

< Using SAG correction circuit >

Csag=22uF, Input signal: White100% to Black, resistance150Ω

Waveform: yellow: input signal, green: Vout signal, purple: Vout1 signal, red: clip length of waveform

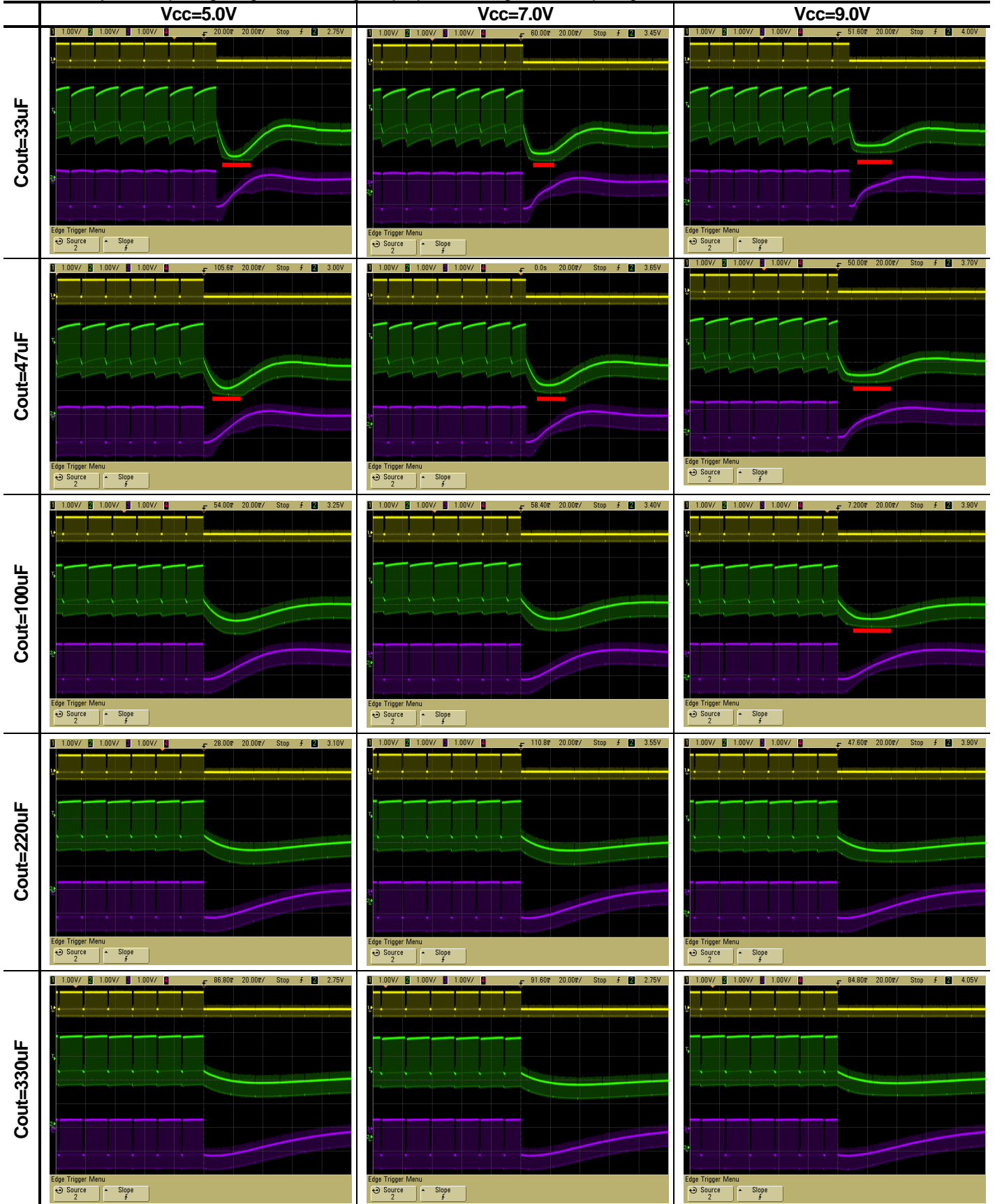

< Using SAG correction circuit >

C<sub>sa</sub>=33uF, Input signal: Black to White 100%, resistance 150Ω

Waveform: yellow: input signal, green: V<sub>out</sub> signal, purple: V<sub>out1</sub> signal, red: clip length of waveform

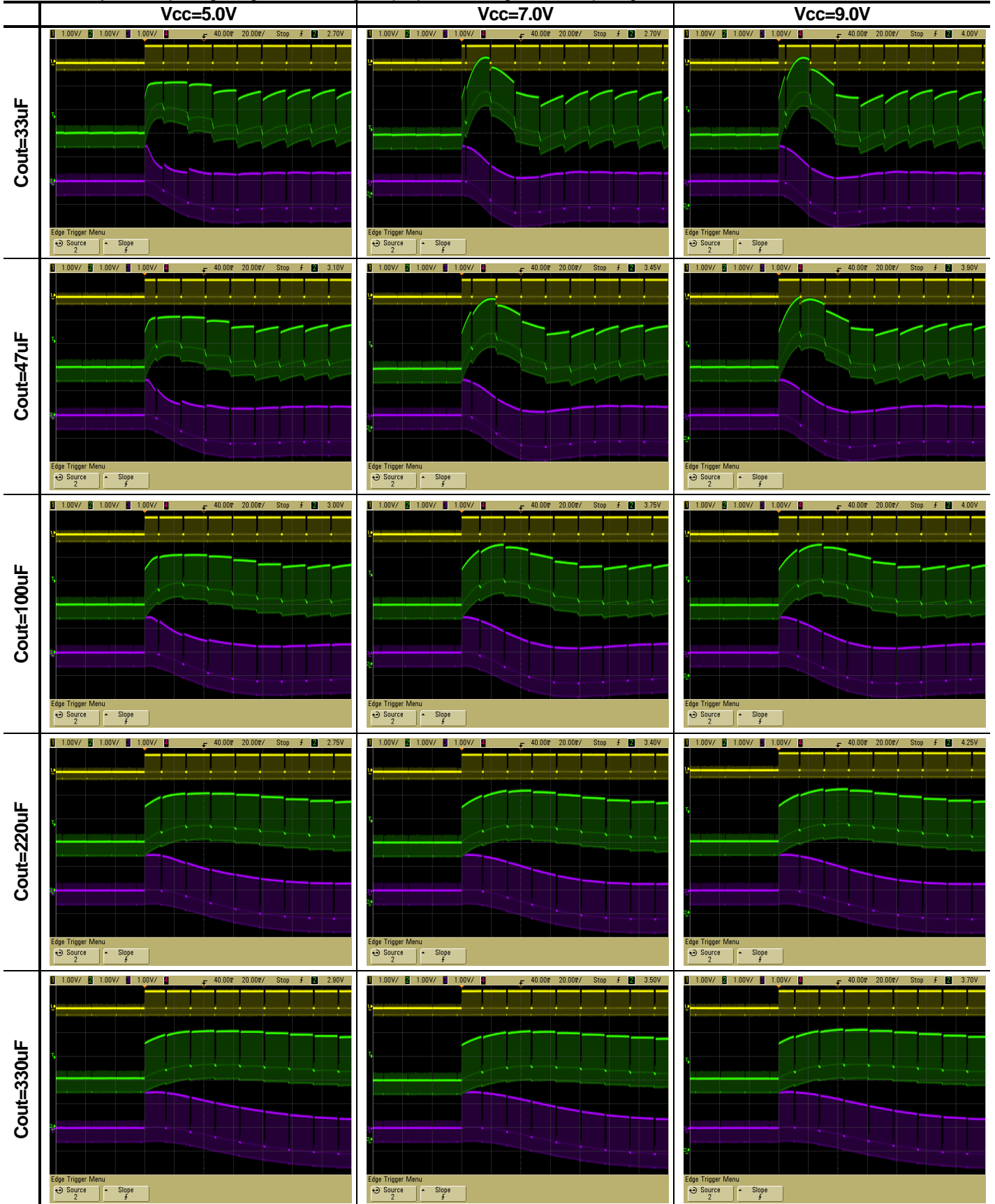



# NJM2267

< Using SAG correction circuit >

C<sub>out</sub>=33uF, Input signal: White100% to Black, resistance150Ω

Waveform: yellow: input signal, green: V<sub>out</sub> signal, purple: V<sub>out1</sub> signal, red: clip length of waveform

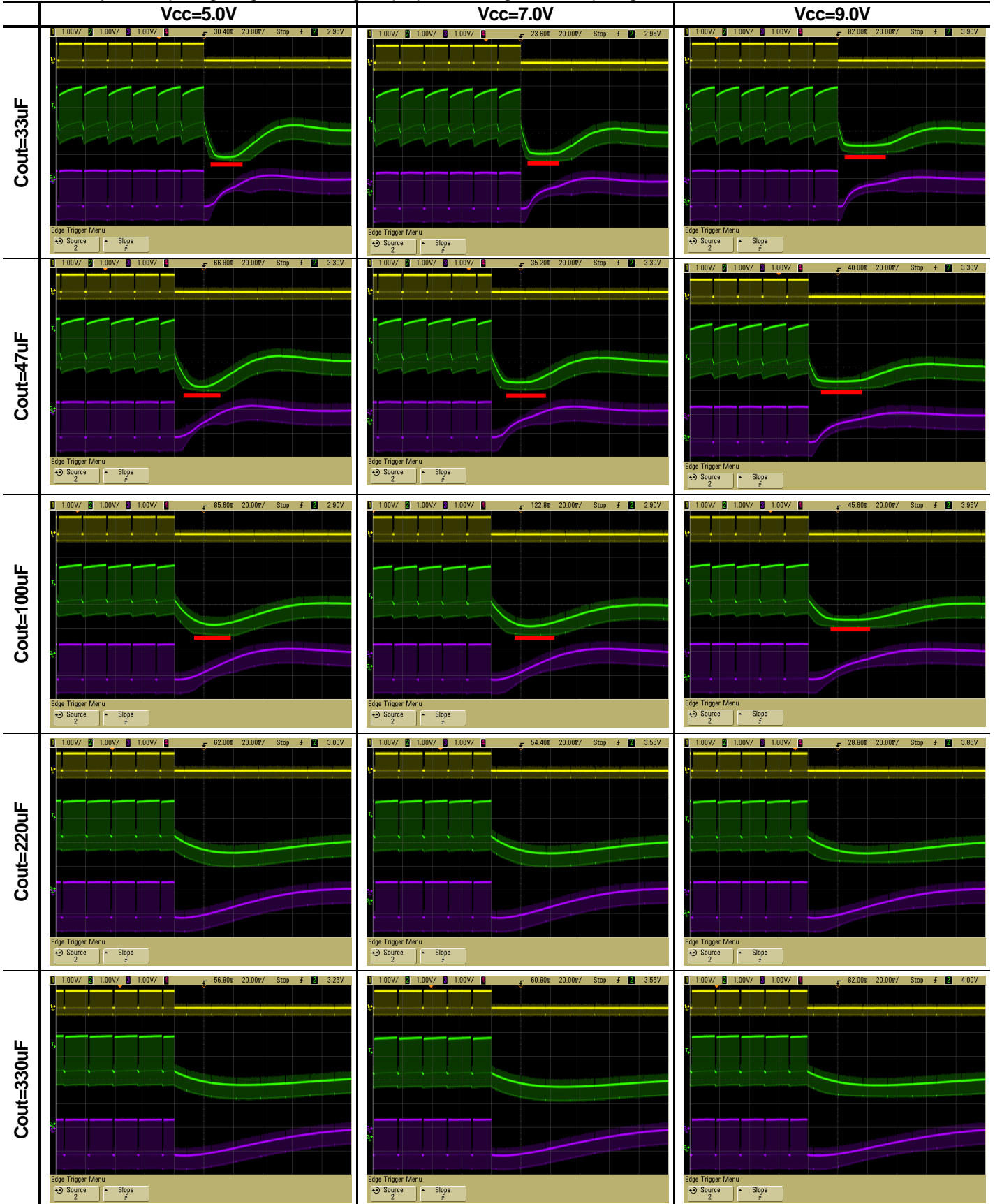

< Not using SAG correction circuit >

Vcc=5V, Input signal: bounce signal (IRE0%, IRE100%, 30Hz), resistance=150Ω

Waveform: yellow: input signal, green: Vout signal, purple: Vout1 signal

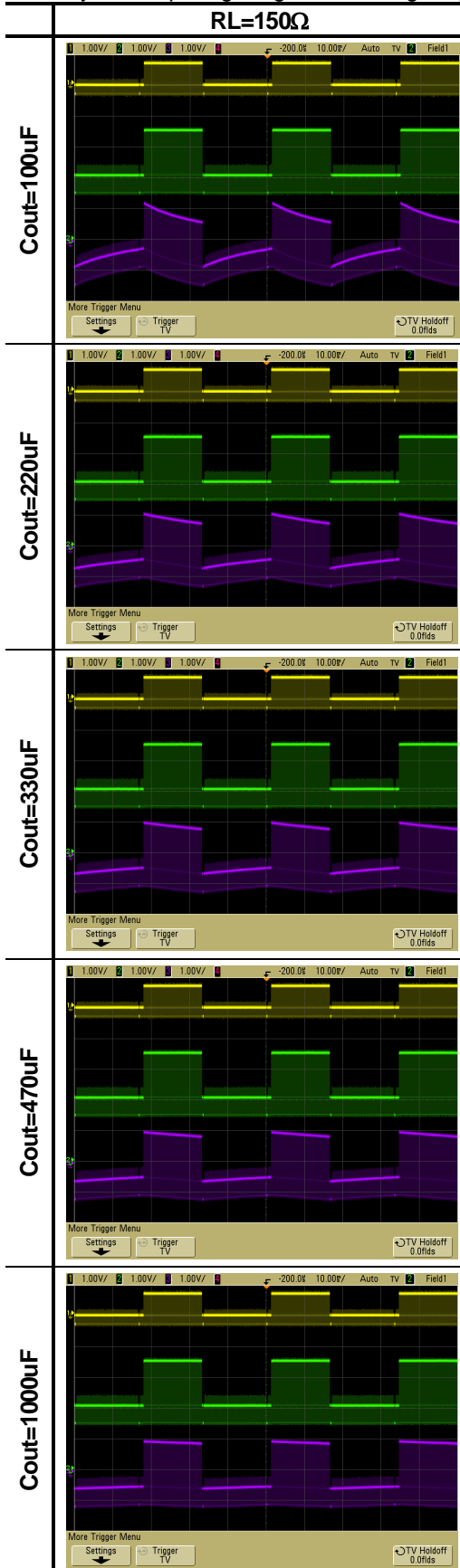

## ■ TYPICAL CHARACTERISTICS

**Operating Current vs. Ta**

(V<sup>+</sup> = 5V)

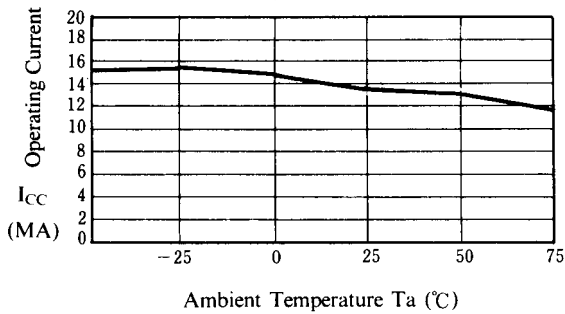

**Input DC Level vs. Ta**

(V<sup>+</sup> = 5V)

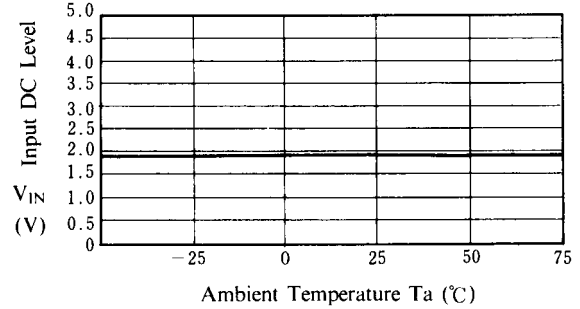

**Output DC Level vs. Ta**

(V<sup>+</sup> = 5V)

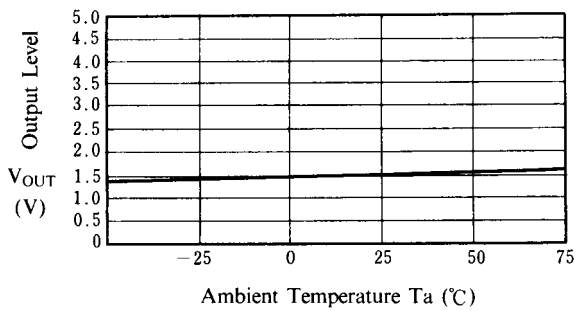

**SAG Terminal Voltage vs. Ta**

(V<sup>+</sup> = 5V)

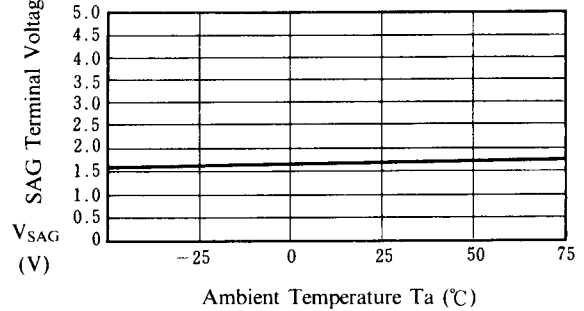

**SAG Terminal Gain vs. Ta**

(V<sup>+</sup> = 5V)

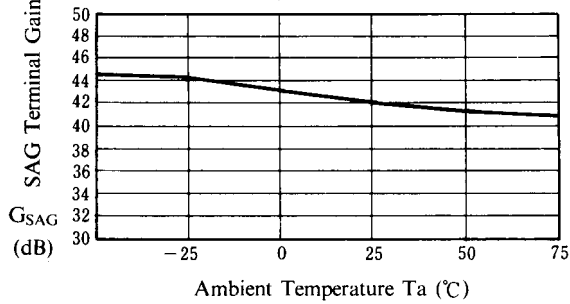

**Voltage Gain vs. Ta (Clamp Type INput)**

(V<sup>+</sup> = 5V, 1V<sub>p-p</sub>, 1MHz, sinewave signal input)

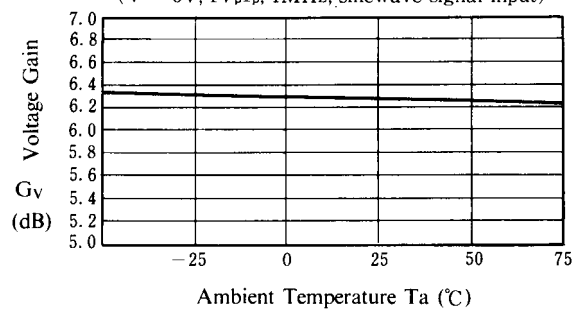

## ■ TYPICAL CHARACTERISTICS

### Gain Frequency Characteristics vs Ta (Clamp Type Input)

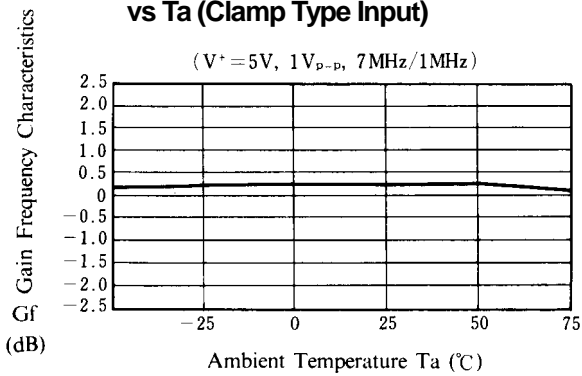

### Differential Gain vs. Ta

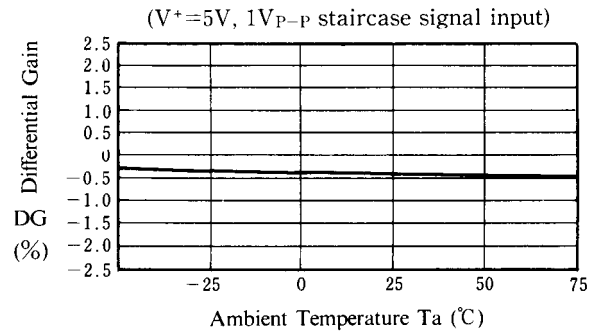

### Differential Phase vs. Ta

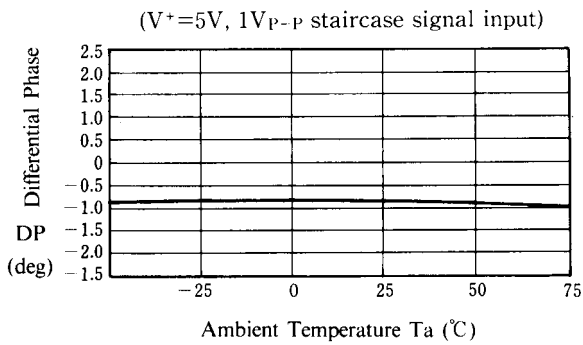

### Operating Current vs. Operating Voltage

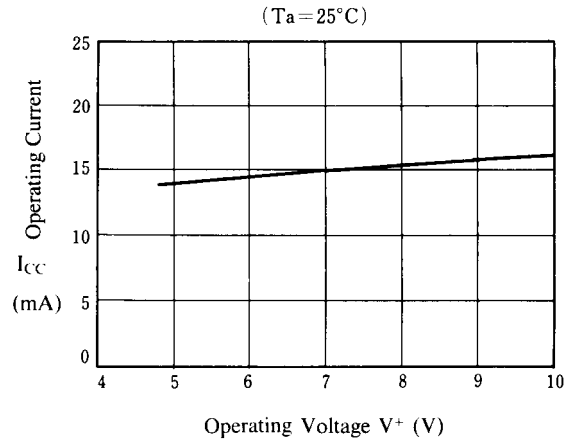

### Input DC Level vs. Operating Voltage

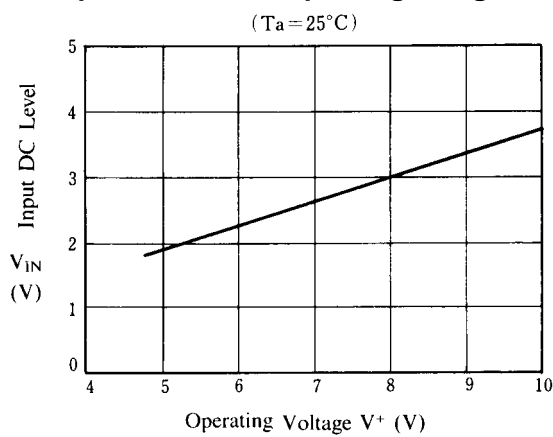

### Output DC Level Vs. Operating Voltage

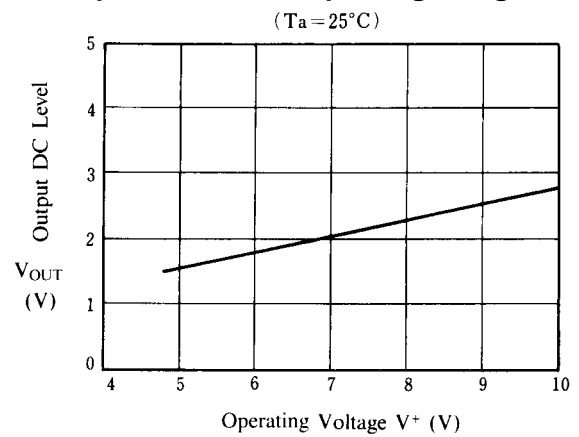

## ■ TYPICAL CHARACTERISTICS

**SAG Terminal Voltage vs. Operating Voltage**

( $T_a = 25^\circ\text{C}$ )

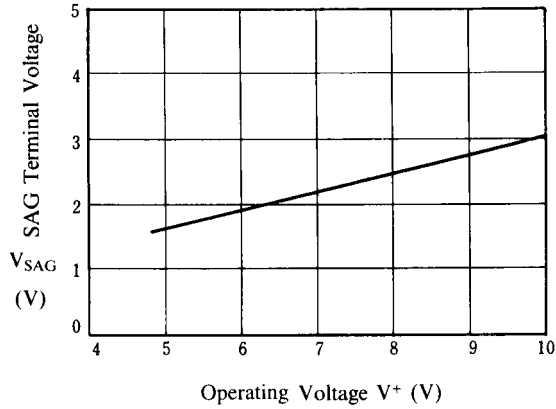

**SAG Terminal Gain vs. Operating Voltage**

( $T_a = 25^\circ\text{C}$ )

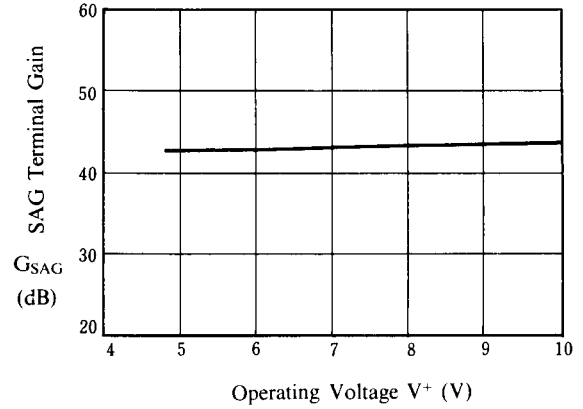

**Voltage Gain vs. Operating Voltage**

( $T_a = 25^\circ\text{C}$ ,  $1V_{P-P}$ , 1MHz sinewave signal input)

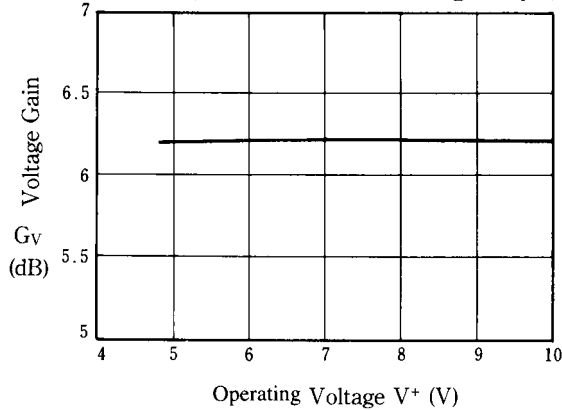

**Gain Frequency Characteristics vs. Operating Voltage**

( $T_a = 25^\circ\text{C}$ ,  $1V_{P-P}$ , 7MHz/1MHz)

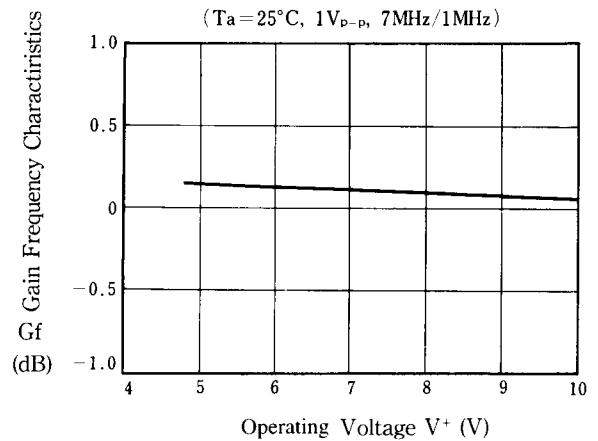

**Differential Gain vs. Operating Voltage**

( $T_a = 25^\circ\text{C}$ ,  $1V_{P-P}$  staircase signal input)

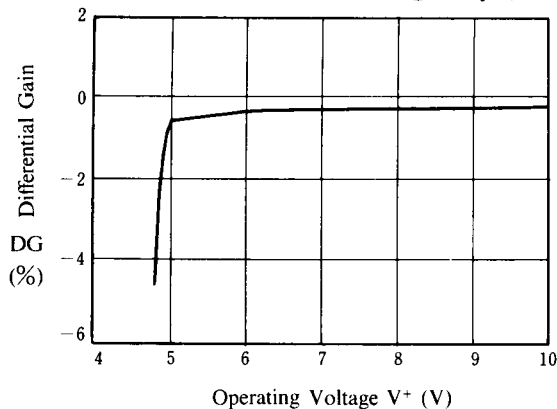

**Differential Phase vs. Operating Voltage**

( $T_a = 25^\circ\text{C}$ ,  $1V_{P-P}$  staircase signal input)

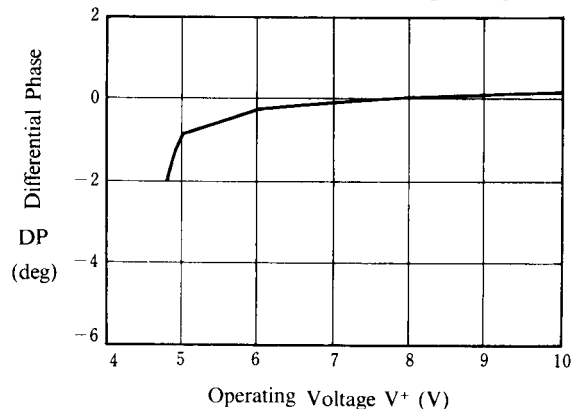

## ■ TYPICAL CHARACTERISTICS

### Voltage Gain vs. Frequency

( $T_a=25^\circ\text{C}$ ,  $V^+=5\text{V}$ ,  $1\text{V}_{\text{P-P}}$  sinewave signal input)

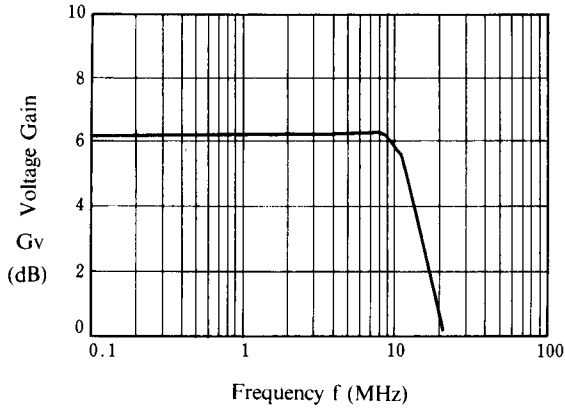

### Small Signal Voltage Gain vs. Frequency

( $T_a=25^\circ\text{C}$ ,  $V^+=5\text{V}_{\text{P-P}}$ ,  $25\text{V}_{\text{P-P}}$  sinewave signal input)

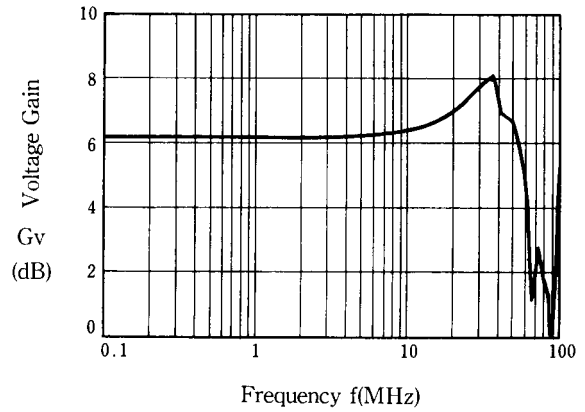

### Cross Talk vs. Frequency

( $T_a=25^\circ\text{C}$ ,  $V^+=5\text{V}$ ,  $1\text{V}_{\text{P-P}}$  sinewave signal input)

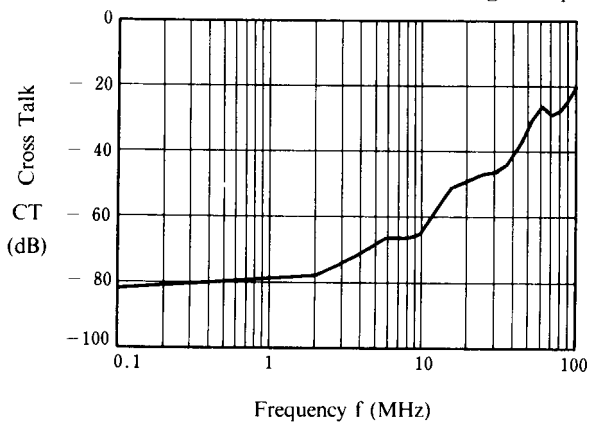

### Voltage Gain vs. $R_L$

( $T_a=25^\circ\text{C}$ ,  $V^+=5\text{V}$ ,  $1\text{V}_{\text{P-P}}$  1MHz sinewave signal input)

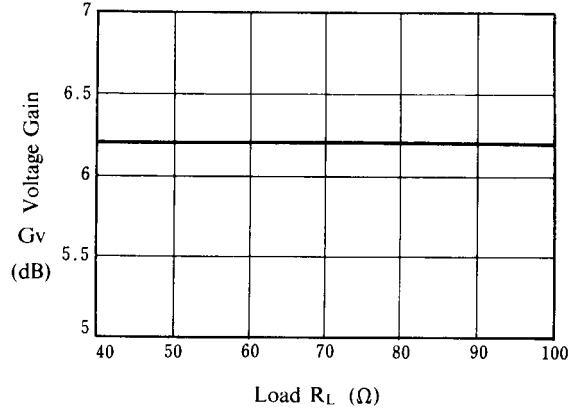

### Gain Frequency Characteristics vs. $R_L$

( $T_a=25^\circ\text{C}$ ,  $V^+=5\text{V}$ ,  $1\text{V}_{\text{P-P}}$ , 7MHz/1MHz)

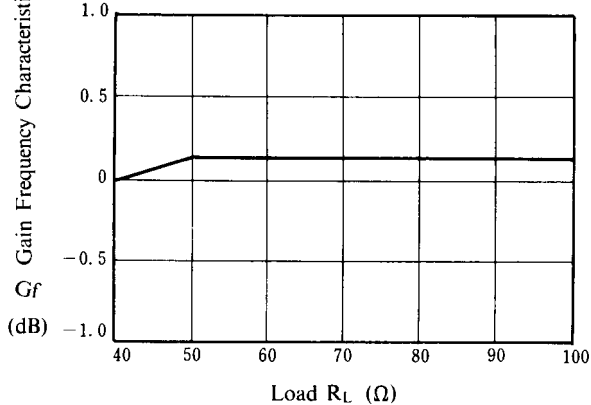

### Differential Gain vs. $R_L$

( $T_a=25^\circ\text{C}$ ,  $V^+=5\text{V}$ ,  $1\text{V}_{\text{P-P}}$  staircase signal input)

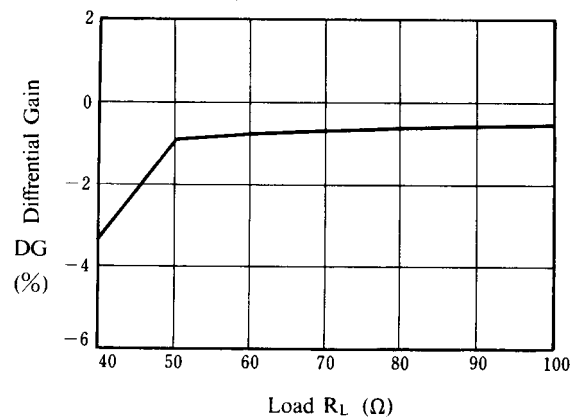

## ■ TYPICAL CHARACTERISTICS

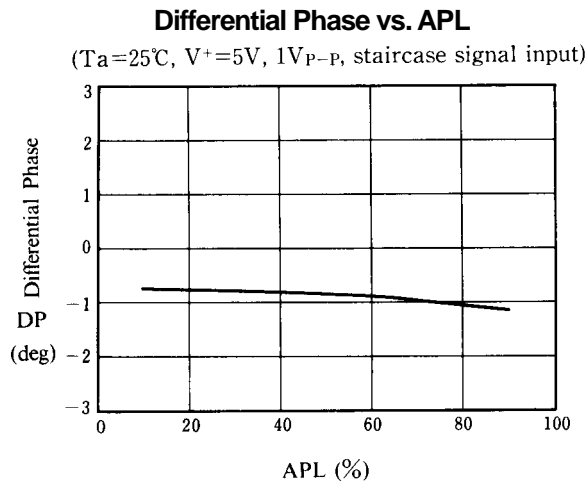
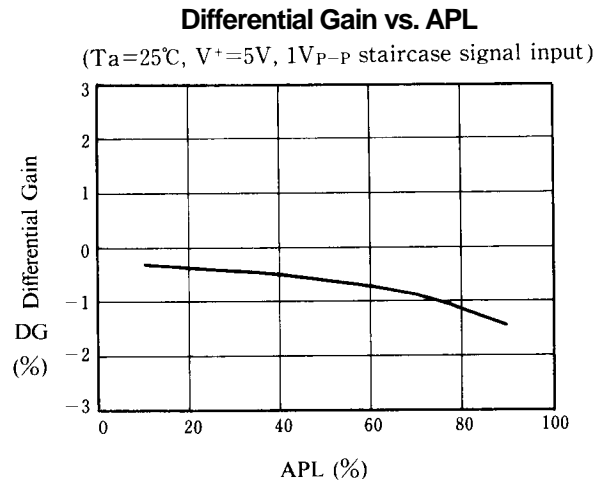
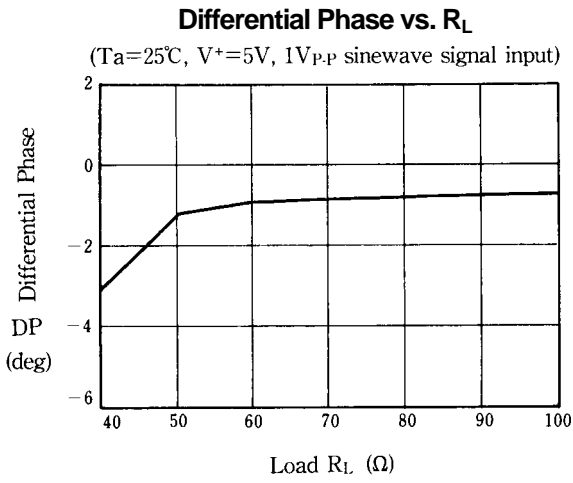

## ■ APPLICATION

This IC requires  $1M\Omega$  resistance between INPUT and GND pin for clamp type input since the minute current causes an unstable pin voltage.

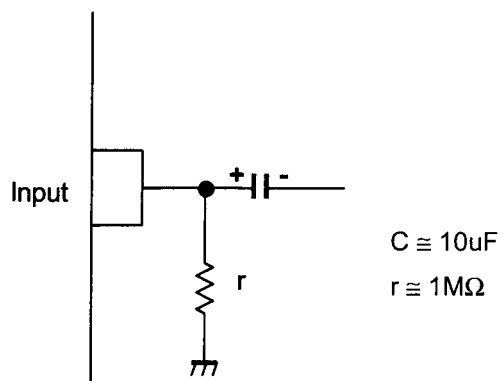

**[CAUTION]**

The specifications on this databook are only given for information, without any guarantee as regards either mistakes or omissions. The application circuits in this databook are described only to show representative usages of the product and not intended for the guarantee or permission of any right including the industrial rights.