

ASE

Hyper-miniature Slide Switches

Washable

RoHS Compliant

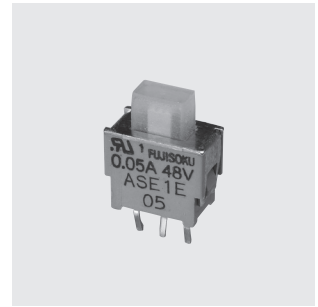

UL

Features

1. High Contact Reliability

Twin-contact clip mechanism for high contact reliability

2. Immersion washable type

3. Gold-plated contacts suitable for low current applications

4. For PC board mounting

5. Improved operability

The independent detent structure provides a light operating touch.

6. UL-recognized

Specifications

Rating	0.4VA AC/DC	Voltage range	20mV~60V
		Current range	1 μ A~50mA
	Max.	50mA 60VAC/DC	
	Min.	1 μ A 20mVAC/DC	
	UL	48VAC/DC 50mA	
	Initial contact resistance	50m Ω max.	(1.5mA 200 μ VAC)
	Dielectric strength	250VAC 1 minute	
	Initial insulation resistance	500M Ω min.	(500VDC)
	Electrical life	10,000 cycles at max. rating.	50,000 cycles at min. rating or 0.4VA
	Operating force	0.69~4.9N	
	Operating temperature range	-20 $^{\circ}$ C~+85 $^{\circ}$ C	
	Storage temperature range	-40 $^{\circ}$ C~+85 $^{\circ}$ C	

Part Numbering

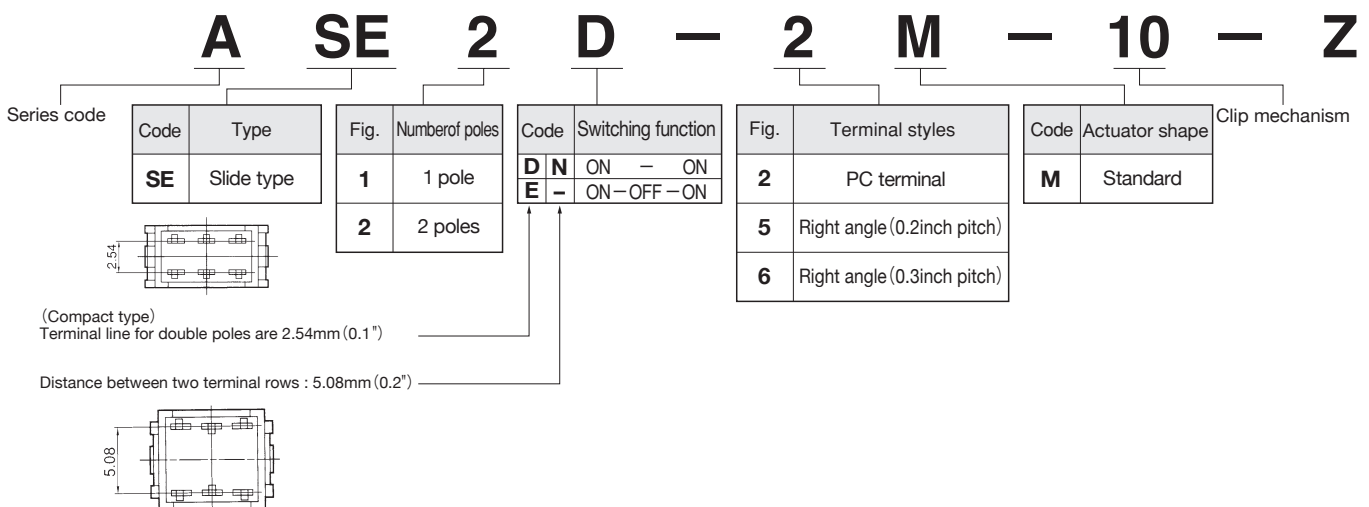

Actuator Shape

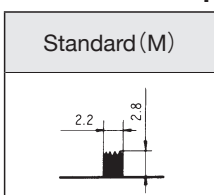

Right Angle Terminals

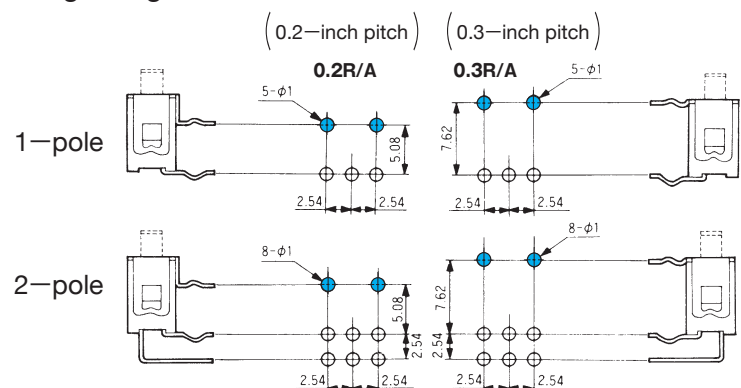

Optional Accessories.

SPDT

PC

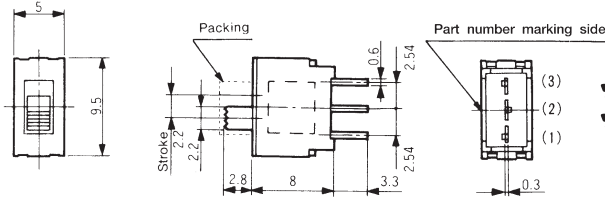
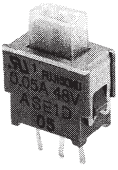

Switching function	Viewed from part No. marking side		
Part No.			
ASE1D-2M-10-Z	ON	—	ON
★ASE1E-2M-10-Z	ON	OFF	ON
Connecting terminals	2-1	—	2-3

Terminal numbers are not shown on the switch.

DPDT

PC



Distance between two terminal rows : 2.54 mm

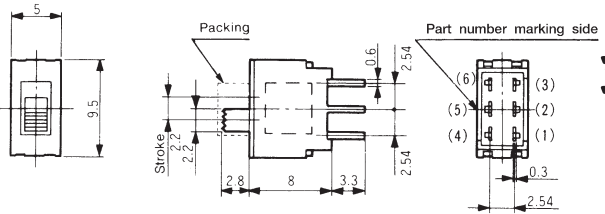

Switching function	Viewed from part No. marking side		
Part No.			
ASE2D-2M-10-Z	ON	—	ON
★ASE2E-2M-10-Z	ON	OFF	ON
Connecting terminals	2-1 5-4	—	2-3 5-6

Terminal numbers are not shown on the switch.

DPDT

PC

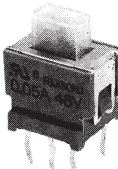

Distance between two terminal rows : 5.08 mm

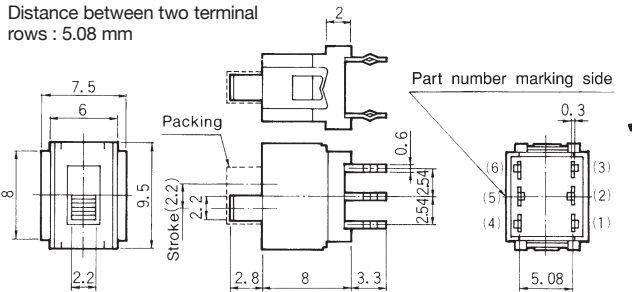

Switching function	Viewed from part No. marking side		
Part No.			
★ASE2N-2M-10-Z	ON	—	ON
Connecting terminals	2-1 5-4	—	2-3 5-6

Terminal numbers are not shown on the switch.

SPDT

0.2R/A

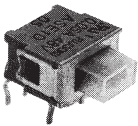

Mounting height : 3.1 mm

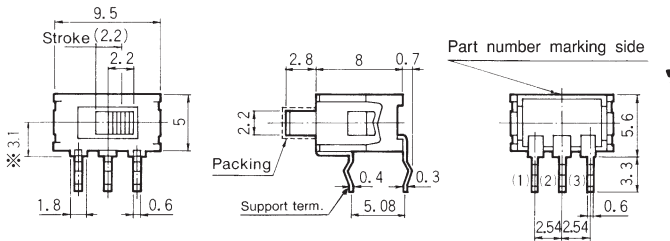

Switching function	Viewed from part No. marking side		
Part No.			
ASE1D-5M-10-Z	ON	—	ON
Connecting terminals	2-1	—	2-3

Terminal numbers are not shown on the switch.

DPDT

0.2R/A

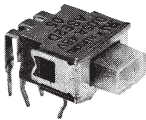

Mounting height : 3.1 mm

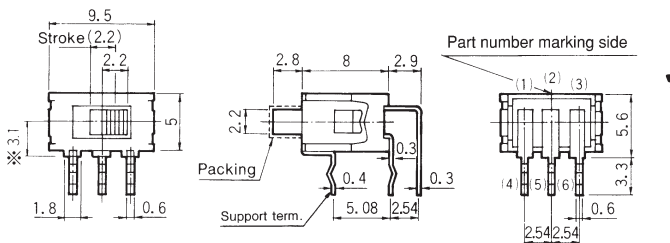

Switching function	Viewed from part No. marking side		
Part No.			
ASE2D-5M-10-Z	ON	—	ON
Connecting terminals	2-1 5-4	—	2-3 5-6

Terminal numbers are not shown on the switch.

★ : Made to order products.

●The actuator is sealed with a white-colored packing. Remove the packing with tweezers after the washing process.

ASE

SPDT

0.3R/A

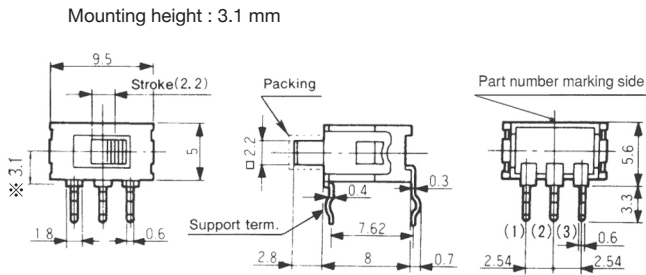
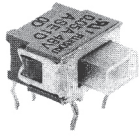

Switching function	Viewed from part No. marking side		
Part No.			
ASE1D-6M-10-Z	ON	—	ON
Connecting terminals	2-1	—	2-3

Terminal numbers are not shown on the switch.

DPDT

0.3R/A

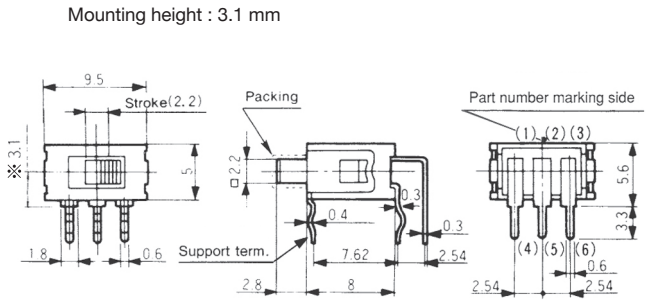
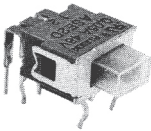

Switching function	Viewed from part No. marking side		
Part No.			
☆ASE2D-6M-10-Z	ON	—	ON
Connecting terminals	2-1 5-4	—	2-3 5-6

Terminal numbers are not shown on the switch.

DPDT

0.3R/A

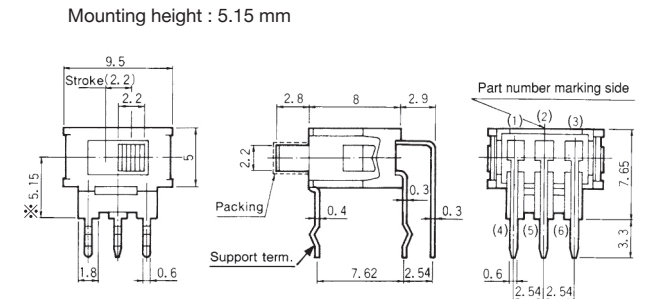
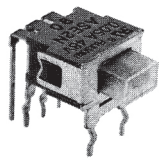

Switching function	Viewed from part No. marking side		
Part No.			
★ASE2N-6M-10-Z	ON	—	ON
Connecting terminals	2-1 5-4	—	2-3 5-6

Terminal numbers are not shown on the switch.

Mounting Height

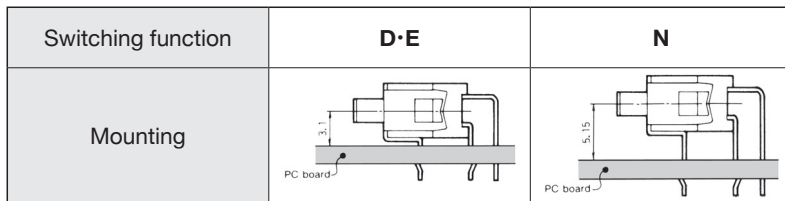

Optional Accessories

(Supplied separately)

Part Name	Bracket
Part No.	14000640324
Dimensions	

PC Hole Layouts

Series	P/C terminal		Right Angle terminal	
	Whithout bracket	Whit bracket	0.2inch pitch	0.3inch pitch
ASE1D ASE1E				
ASE2D ASE2E				
ASE2N				

★ : Made to order products.

☆ : Semi-standard products.

Bracket Installation Procedure

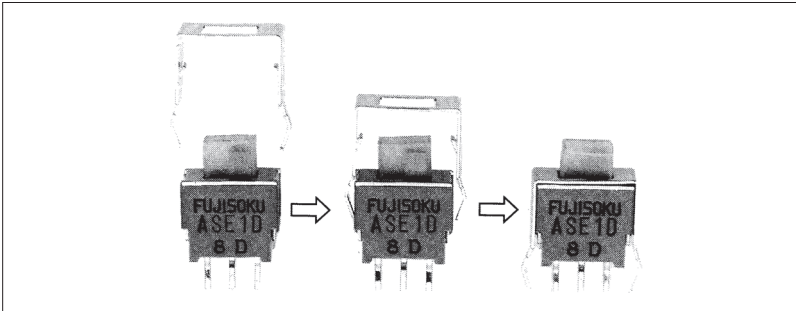

Handling Precautions (AS and ASE Series)

1. Soldering Specifications

- (1) Manual Soldering
 - Device : Soldering iron
 - 380°C, Max.; 3 seconds, Max.
- (2) Auto Soldering
 - Device : Jet wave type or dip type
 - 275°C, Max.; 6 seconds, Max.
 - Pre-heating should be done at temperatures ranging from 80°C to 120°C and within 120 sec.

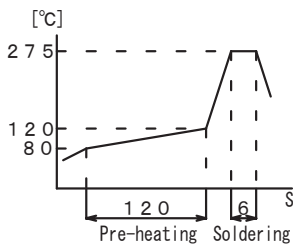

2. Flux Cleaning

- (1) Solvent : Fluorine or Alcohol type.
- (2) Cleaning after soldering should be done after the terminal temperature falls to 90°C or below, or after leaving the switch for five minutes or longer at room temperature.
 - AS series are not process sealed and are not washable. If the PC board is to be cleaned, clean the soldering surface of substrate with a brush so that the switch is not exposed to the cleaning solution.
- (3) Do not use ultrasonic cleaning system.

3. Mounting of Switch

- (1) Use the PC boards of $\phi 1$ holes.
- (2) Do not bend the terminals before mounting the switch on the PC board.
- (3) After mounting the switch, do not place the device in such a way that the device weight will be applied on the knob, etc. of the switch.
- (4) Do not apply load exceeding 12.7 N (1.3 kgf) to the knob. Use a bracket (optional accessory) if the load is expected to exceed 12.7 N (1.3 kgf). The strength of the knob will be reinforced to 29.4 N (3 kgf) max..

Packaging Specifications

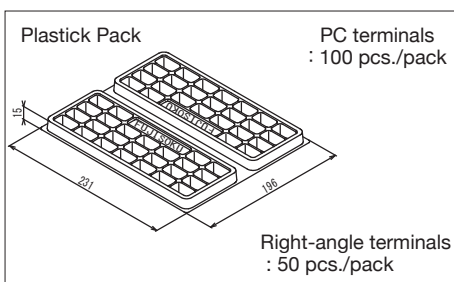

Certifications

■ Handling Precautions

1. Soldering Specifications

(1) Manual Soldering



Device : Soldering iron 350°C, Max.; 3 seconds, Max.

2. Flux Cleaning

(1) Solvent : Fluorine or Alcohol type.

(2) are not process sealed. If the PC board is to be cleaned, clean the soldering surface of the substrate with a brush so that the switch is not exposed to the cleaning solution.

■ UL Recognized / CSA Certified

Classification	Part No.		page	Part No.		page
Slide switches	ASE1D-2M-10-Z	●	494	ASE1D-5M-10-Z	●	494
	ASE1E-2M-10-Z	●	494	ASE2D-5M-10-Z	●	494
	ASE2D-2M-10-Z	●	494	ASE1D-6M-10-Z	●	494
	ASE2E-2M-10-Z	●	494	ASE2D-6M-10-Z	●	494
	ASE2N-2M-10-Z	●	494	ASE2N-6M-10-Z	●	494
	8SS1011-Z	●	501			
	8SS1012-Z	●	501			
	8SS1021-Z	●	501			
	8SS1022-Z	●	501			
	8SS2011-Z	●	501			
	8SS2012-Z	●	501			
	8SS2021-Z	●	501			
	8SS2022-Z	●	501			

● UL-recognized or CSA-certified products.

● : UL File No. E43275

CSA File No. LR38341

Note: Please refer to P.575 for more details on UL-recognized / CSA-certified products.

Additional cost will be required.

■ Table of Part Numbers

Series	Switching function	TAB terminals		Screw terminals	Solder terminals	
		1-pole	2-poles	1-pole	1-pole	2-poles
ES (15A)	OFF - ON	★ ES115A-Z	—	—	★ ES115A12-Z	—
	ON - ON	★ ES115D-Z	ES215N-Z	—	★ ES115D12-Z	—
	ON-OFF-ON	★ ES115E-Z	★ ES215P-Z	—	—	—
ES (25A)	OFF - ON	—	—	★ ES125A10-Z	★ ES125A12-Z	—
	ON - ON	—	—	—	★ ES125D12-Z	★ ES225N12-Z

■ **Shorting (Make-Before-Break)**

A switch which momentarily connects both circuits when the actuator is moved from Point A to B in the below figure.

All switches which are not marked as "Shorting" are "Non-shorting" (Break-Before-Make).

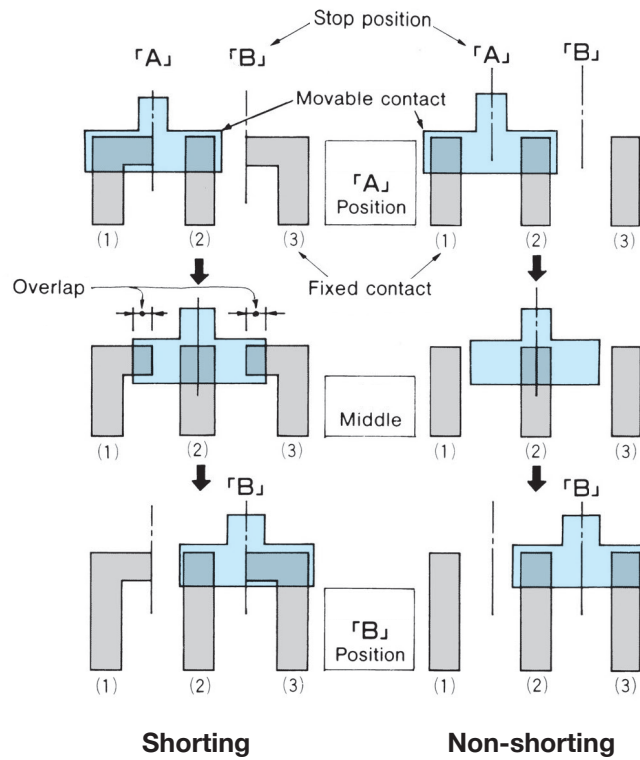

[Fig.1.]