

Surface Mount Specialty Polymer Solid Aluminum Electrolytic Capacitors

NSPX Series

FEATURES

- HIGH VOLTAGE MULTILAYER SOLID POLYMER ALUMINUM CAPACITOR
- LOW PROFILE (1.1MM ~ 1.9MM HEIGHT), RESIN PACKAGE
- HIGH RIPPLE CURRENT AND SURGE VOLTAGE CAPABILITIES
- FITS EIA (7343) "D" AND "E" TANTALUM CHIP LAND PATTERNS
- Pb-FREE AND COMPATIBLE WITH REFLOW SOLDERING

RoHS Compliant
includes all homogeneous materials

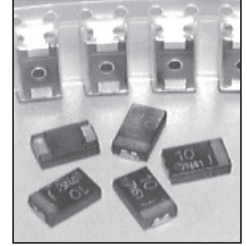

*See Part Number System for Details

CHARACTERISTICS

Rated Working Range	10 ~ 35VDC	
Rated Capacitance Range	10 ~ 100 μ F	
Operating Temperature Range	-55 ~ +105°C	
Capacitance Tolerance	\pm 20% (M)	
Max. Leakage Current (μ A) After 2 Minutes (+20°C)	\leq 0.3CV	
Max. Tan δ , 120Hz, +20°C	0.06	
High Temperature Load Life 2,000 Hours @ 105°C at Rated Working Voltage	Capacitance Change	Within \pm 20% of initial measured value
	Tan δ	Less than 200% specified max. value
	Leakage Current	Less than specified max. value
Damp Heat Test 500 Hours @ +60°C at 90% RH without load	Capacitance Change	Within -20%/+60% of initial measured value
	Tan δ	Less than 200% of specified max. value
	Leakage Current	\leq 0.9CV

STANDARD PRODUCTS AND SPECIFICATIONS

NIC Part Number	WV	SV	Cap. (μ F)	Max. LC (μ A)	Tan δ	Max. Ripple Current +45°C & 100KHz (mArms)	Max. ESR +20°C & 100KHz (Ω)	Height H
	(Vdc)							
NSPX470M10D5ATRF	10	12.5	47	141.0	0.06	3200	0.04	1.1 \pm 0.1
NSPX470M10D6ATRF	10	12.5	47	141.0	0.06	3200	0.04	1.9 \pm 0.1
NSPX680M10D1ATRF	10	12.5	68	204.0	0.06	3200	0.04	1.4 \pm 0.1
NSPX680M10D6ATRF	10	12.5	68	204.0	0.06	3200	0.04	1.9 \pm 0.1
NSPX101M10D6ATRF	10	12.5	100	300.0	0.06	3200	0.04	1.9 \pm 0.1
NSPX150M16D5ATRF	16	20	15	72.0	0.06	3200	0.04	1.1 \pm 0.1
NSPX150M16D6ATRF	16	20	15	72.0	0.06	3200	0.04	1.9 \pm 0.1
NSPX220M16D5ATRF	16	20	22	105.6	0.06	3200	0.04	1.1 \pm 0.1
NSPX220M16D6ATRF	16	20	22	105.6	0.06	3200	0.04	1.9 \pm 0.1
NSPX330M16D5ATRF	16	20	33	158.4	0.06	3200	0.04	1.1 \pm 0.1
NSPX330M16D6ATRF	16	20	33	158.4	0.06	3200	0.04	1.9 \pm 0.1
NSPX470M16D1ATRF	16	20	47	225.6	0.06	3200	0.04	1.4 \pm 0.1
NSPX470M16D6ATRF	16	20	47	225.6	0.06	3200	0.04	1.9 \pm 0.1
NSPX680M16D6ATRF	16	20	68	326.4	0.06	3200	0.04	1.9 \pm 0.1
NSPX100M20D5ATRF	20	23	10	60.0	0.06	3200	0.04	1.1 \pm 0.1
NSPX150M20D5ATRF	20	23	15	90.0	0.06	3200	0.04	1.1 \pm 0.1
NSPX220M20D5ATRF	20	23	22	132.0	0.06	3200	0.04	1.1 \pm 0.1
NSPX220M20D6ATRF	20	23	22	132.0	0.06	3200	0.04	1.9 \pm 0.1
NSPX330M20D1ATRF	20	23	33	198.0	0.06	3200	0.04	1.4 \pm 0.1
NSPX330M20D6ATRF	20	23	33	198.0	0.06	3200	0.04	1.9 \pm 0.1
NSPX470M20D1ATRF	20	23	47	282.0	0.06	3200	0.04	1.4 \pm 0.1
NSPX470M20D6ATRF	20	23	47	282.0	0.06	3200	0.04	1.9 \pm 0.1
NSPX560M20D6ATRF	20	23	56	336.0	0.06	3200	0.04	1.9 \pm 0.1
NSPX100M25D5ATRF	25	29	10	75.0	0.06	3200	0.04	1.1 \pm 0.1
NSPX150M25D5ATRF	25	29	15	112.5	0.06	3200	0.04	1.1 \pm 0.1
NSPX150M25D6ATRF	25	29	15	112.5	0.06	3200	0.04	1.9 \pm 0.1
NSPX220M25D1ATRF	25	29	22	165.0	0.06	3200	0.04	1.4 \pm 0.1
NSPX220M25D6ATRF	25	29	22	165.0	0.06	3200	0.04	1.9 \pm 0.1
NSPX330M25D6ATRF	25	29	33	247.5	0.06	3200	0.04	1.9 \pm 0.1
NSPX100M35D5ATRF	35	40	10	105.0	0.06	3200	0.04	1.1 \pm 0.1
NSPX150M35D1ATRF	35	40	15	157.5	0.06	3200	0.04	1.4 \pm 0.1
NSPX150M35D6ATRF	35	40	15	157.5	0.06	3200	0.04	1.9 \pm 0.1
NSPX220M35D6ATRF	35	40	22	231.0	0.06	3200	0.04	1.9 \pm 0.1

RIPPLE CURRENT TEMPERATURE

CORRECTION FACTORS

Correction Factor	\leq 45°C	45°C < T \leq 85°C	85°C < T \leq 105°C
All Values	1.0	0.80	0.50



NIC COMPONENTS CORP. www.niccomp.com | www.lowESR.com | www.RFpassives.com | www.SMTmagnetics.com

SPECIFICATIONS ARE SUBJECT TO CHANGE

Surface Mount Specialty Polymer Solid Aluminum Electrolytic Capacitors

NSPX Series

PART NUMBERING SYSTEM

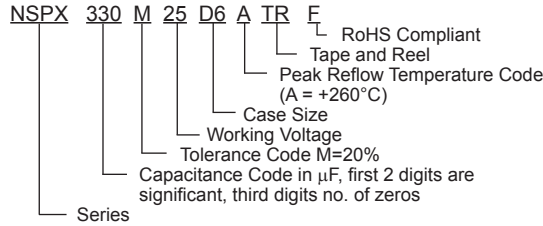

RECOMMENDED 260°C REFLOW SOLDERING PROFILE

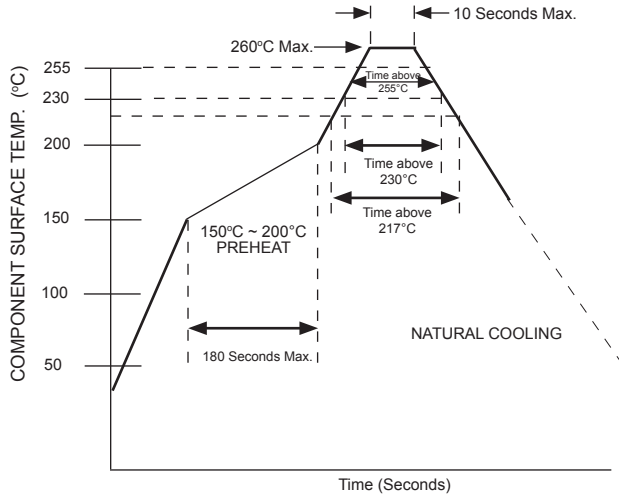

Item	Maximum Duration
Peak Temperature +260°C	10 seconds max.
Time above +255°C	30 seconds max.
Time above +230°C	130 seconds max.
Time above +217°C	150 seconds max.

- Notes: Compliant to IPC/J-STD-020D standard
- SAC alloy (+217°C) reflow soldering compatible
 - Soldering heat limits apply to the top surface of component
 - If you have concerns about your reflow soldering profile review them with NIC to insure compatible [tpmg@niccomp.com]
 - Three reflow passes are allowed (cooling down period to room temperature between each pass).

Storage Conditions:
 Temperature: +5°C ~ +30°C
 Humidity: <60% RH
 Packaging: Moisture barrier bag
 Storage Time: Parts should be soldered within 2 years of the production date and/or within 7 days of opening the moisture barrier bag.

DIMENSIONS (mm)

Case Code	L ± 0.2	W ± 0.2	H	W1 ± 0.1	S ± 0.3
D1, D5 & D6	7.3	4.3	see values table	2.4	1.3

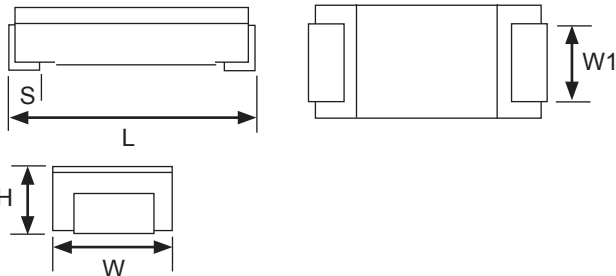

VOLTAGE CODES

Voltage	Code
10Vdc	A
16Vdc	C
20Vdc	D
25Vdc	E
35Vdc	V

RECOMMENDED LAND PATTERNS (mm)

Case Code	A	B	C
D1, D5 & D6	2.4	2.8	4.0

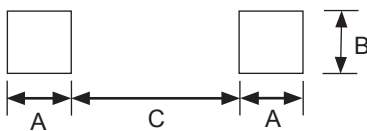

Please note the NSP series will fit on standard "D" and "E" size (7343) tantalum chip capacitor land patterns

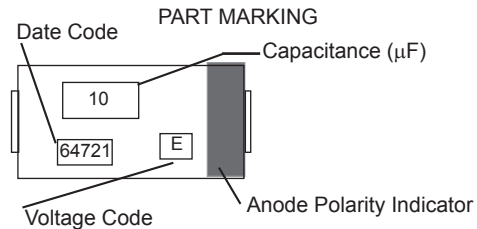

TERMINATION MATERIAL:

D1, D5 and D6 Case Sizes
 Base: Fe (~ 100 μm)
 Under Plating: Cu (~ 5 μm)
 Finish Plating: Sn (5 ~ 9 μm)

PRECAUTIONS

Please review the notes on correct use, safety and precautions found on our website at www.niccomp.com/precautions
 If in doubt or uncertainty, please review your specific application - process details with NIC's technical support personnel: tpmg@niccomp.com



Surface Mount Specialty Polymer Solid Aluminum Electrolytic Capacitors

NSPX Series

CARRIER TAPE DIMENSIONS (mm)

Case Code	A±0.2	B±0.2	Dφ	E±0.1	F±0.1	P ₀ ±0.1	P ₁ ±0.1	t±0.2	W±0.3
D1	7.6	4.5	1.5 ^{+0.1}	5.50	1.75	4.0	8.0	2.4	12.0
D5								1.5	
D6								2.4	

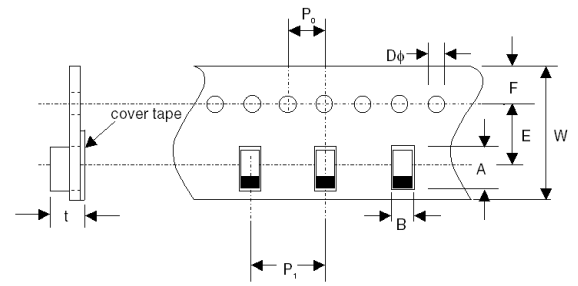

REEL DIMENSIONS (mm)

A±2.0	B ±1.0	C±0.5	D±0.8	E±0.5	T±1.0	t	W±1.0
φ330	φ80	φ13.0	φ21.0	2.0	20.0	3.0	14

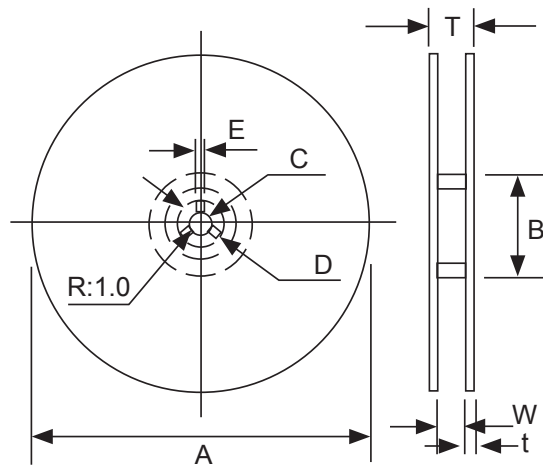

Case Code	Reel Quantity
D1, D5 & D6,	3,500

