



3 V, SUPER MINIMOLD SILICON MMIC WIDEBAND AMPLIFIER

UPC2745TB
UPC2746TB

FEATURES

- **HIGH DENSITY SURFACE MOUNTING:**
6 pin super minimold or SOT-363 package
- **LOW SUPPLY VOLTAGE:** $V_{CC} = 1.8$ to 3.3 V
- **WIDEBAND RESPONSE:**
UPC2745TB: $f_u = 2.7$ GHz TYP
UPC2746TB: $f_u = 1.5$ GHz TYP
- **HIGH ISOLATION:**
UPC2745TB: ISOL = 38 dB TYP
UPC2746TB: ISOL = 45 dB TYP

DESCRIPTION

NEC's UPC2745TB and UPC2746TB are Silicon MMIC Wideband Amplifiers manufactured using NEC's 20 GHz f_T NESAT™ III silicon bipolar process. These devices are designed for use as buffer amps in mobile communication applications such as Cellular, PCS, and Cordless handsets, and WLAN transceivers. The UPC2745/46TB are pin compatible and have comparable performance as the larger UPC2745/46T, so they are suitable for use as a replacement to help reduce system size. These IC's are housed in a 6 pin super minimold or SOT-363 package.

NEC's stringent quality assurance and test procedure ensure the highest reliability and performance.

TYPICAL PERFORMANCE CURVES

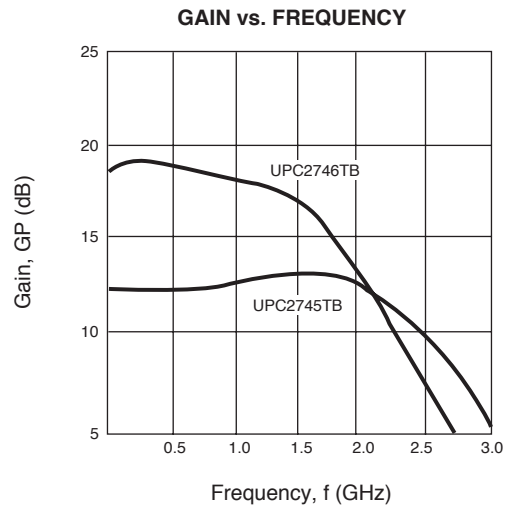

ELECTRICAL CHARACTERISTICS (TA = +25 °C, ZL = ZS = 50 Ω)

PART NUMBER PACKAGE OUTLINE			UPC2745TB S06			UPC2746TB S06		
SYMBOLS	PARAMETERS AND CONDITIONS	UNITS	MIN	TYP	MAX	MIN	TYP	MAX
I _{CC}	Circuit Current (no signal), $V_{CC} = 3.0$ V $V_{CC} = 1.8$ V	mA mA	5.0	7.5 4.5	10.0	5.0	7.5 4.5	10.0
GP	Power Gain, $V_{CC} = 3.0$ V, $f = 0.5$ GHz $V_{CC} = 3.0$ V, $f = 1$ GHz $V_{CC} = 3.0$ V, $f = 2$ GHz $V_{CC} = 1.8$ V, $f = 500$ MHz	dB dB dB dB	9.0	12 12 11 7	14	16	19 18.5 14	21
f_u	Upper Limit Operating Frequency (3 dB down from the gain at $f = 100$ MHz) $V_{CC} = 3.0$ V $V_{CC} = 1.8$ V	GHz GHz	2.3	2.7 1.8		1.1	1.5 1.1	
P _{O(SAT)}	Maximum Output Level $V_{CC} = 3.0$ V, $f = 0.5$ GHz, P _{IN} = -6 dBm $V_{CC} = 3.0$ V, $f = 1$ GHz, P _{IN} = -6 dBm $V_{CC} = 3.0$ V, $f = 2$ GHz, P _{IN} = -6 dBm $V_{CC} = 1.8$ V, $f = 500$ MHz, P _{IN} = -10 dBm	dBm dBm dBm dBm	-4	-1 -2.5 -3.5 -11		-3	0 -1 -8	
NF	Noise Figure, $V_{CC} = 3.0$ V, $f = 0.5$ GHz $V_{CC} = 3.0$ V, $f = 1$ GHz $V_{CC} = 3.0$ V, $f = 2$ GHz $V_{CC} = 1.8$ V, $f = 500$ MHz	dB dB dB dB		6 5.5 5.7 8.0	7.5		4.0 4.2 5.0	5.5

ELECTRICAL CHARACTERISTICS (T_A = +25 °C, Z_L = Z_S = 50 Ω)

PART NUMBER PACKAGE OUTLINE			UPC2745TB S06			UPC2746TB S06		
SYMBOLS	PARAMETERS AND CONDITIONS	UNITS	MIN	TYP	MAX	MIN	TYP	MAX
RLIN	Input Return Loss, V _{CC} = 3.0 V, f = 0.5 GHz V _{CC} = 3.0 V, f = 1 GHz V _{CC} = 3.0 V, f = 2 GHz V _{CC} = 1.8 V, f = 0.5 GHz	dB dB dB dB	8	11 13 14 6.5		10	13 10 10	
RLOUT	Output Return Loss, V _{CC} = 3.0 V, f = 0.5 GHz V _{CC} = 3.0 V, f = 1 GHz V _{CC} = 3.0 V, f = 2 GHz V _{CC} = 1.8 V, f = 0.5 GHz	dB dB dB dB	2.5	5.5 6.5 8.5 6.0		5.5	8.5 8.5 9.5	
ISOL	Isolation, V _{CC} = 3.0 V, f = 0.5 GHz V _{CC} = 3.0 V, f = 1 GHz V _{CC} = 3.0 V, f = 2 GHz V _{CC} = 1.8 V, f = 0.5 GHz	dB dB dB dB	33	38 33 30 35		40	45 38 37	
IM3	3rd Order Intermodulation Distortion V _{CC} = 3.0 V, P _{OUT} = -20 dBm, f ₁ = 500 MHz, f ₂ = 502 MHz V _{CC} = 3.0 V, P _{OUT} = -20 dBm, f ₁ = 1000 MHz, f ₂ = 1002 MHz V _{CC} = 1.8 V, P _{OUT} = -20 dBm, f ₁ = 500 MHz, f ₂ = 502 MHz	dBc dBc dBc		-54 -50 -31			-51 -37	

ABSOLUTE MAXIMUM RATINGS¹ (T_A = 25°C)

SYMBOLS	PARAMETERS	UNITS	RATINGS
V _{CC}	Supply Voltage (Pin 5, Pin 8)	V	4.0
P _{IN}	Input Power	dBm	0
P _T	Total Power Dissipation ²	mW	200
T _{OP}	Operating Temperature	°C	-45 to +85
T _{STG}	Storage Temperature	°C	-55 to +150

**RECOMMENDED
OPERATING CONDITIONS**

SYMBOL	PARAMETER	UNITS	MIN	TYP	MAX
V _{CC}	Supply Voltage	V	2.7	3.0	3.3
T _{OP}	Operating Temperature	°C	-40	+25	+85

Notes:

1. Operation in excess of any one of these parameters may result in permanent damage.
2. Mounted on double sided copper clad 50 x 50 x 1.6 mm epoxy glass PWB (T_A = +85°C).

PIN DESCRIPTION

Pin No.	Pin Name	Applied Voltage (V)	Description	Internal Equivalent Circuit
1	Input		Signal input pin. An internal matching circuit, configured with resistors, enables 50 Ω connection over a wide bandwidth. This pin must be coupled to the signal source with a blocking capacitor.	
4	Output		Signal output pin. An internal matching circuit, configured with resistors, enables 50 Ω connection over a wide bandwidth. This pin must be coupled to the output load with a blocking capacitor.	
6	V _{CC}	2.7 to 3.3	Power supply pin. This pin should be externally equipped with a bypass capacitor to minimize ground impedance.	
2 3 5	GND	0	Ground pin. This pin should be connected to system ground with minimum inductance. Ground pattern on the board should be formed as wide as possible. All the ground pins must be connected together with wide ground pattern to minimize impedance difference.	

TYPICAL PERFORMANCE CURVES (TA = 25°C)

UPC2745TB
CURRENT vs. VOLTAGE

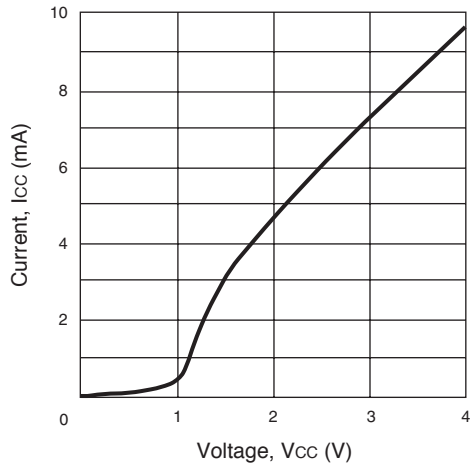

UPC2745TB
CURRENT vs. TEMPERATURE AND VOLTAGE

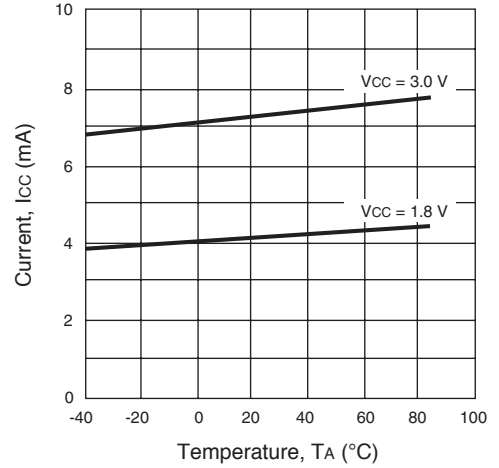

UPC2745TB
GAIN AND NOISE FIGURE vs.
FREQUENCY AND VOLTAGE

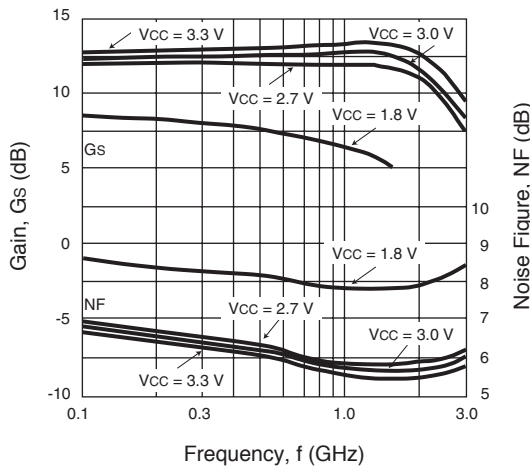

UPC2745TB
GAIN vs.
FREQUENCY AND TEMPERATURE

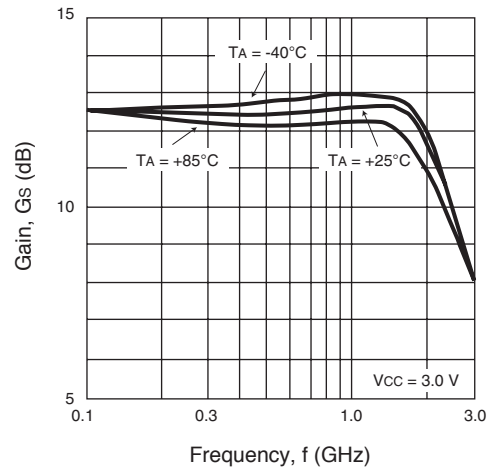

UPC2745TB
ISOLATION vs.
FREQUENCY AND VOLTAGE

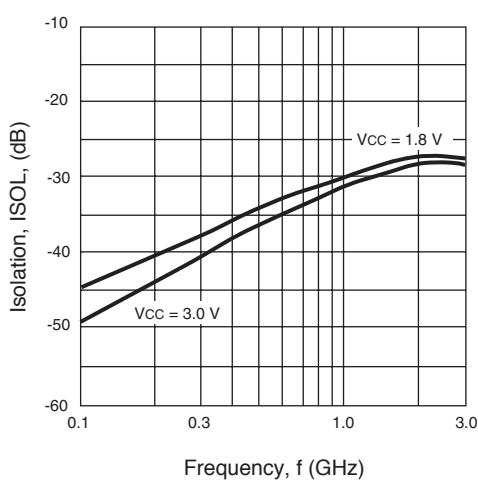

UPC2745TB
INPUT RETURN LOSS AND OUTPUT RETURN
LOSS vs. FREQUENCY AND VOLTAGE

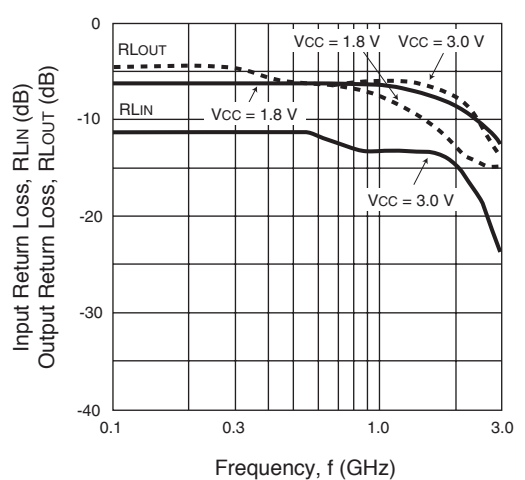

TYPICAL PERFORMANCE CURVES (TA = 25°C)

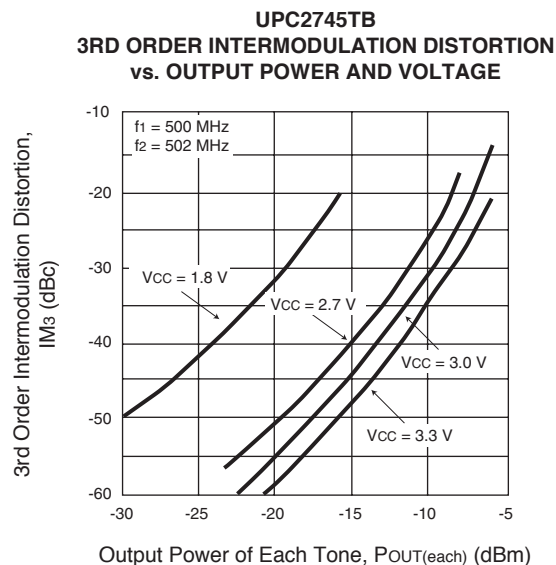
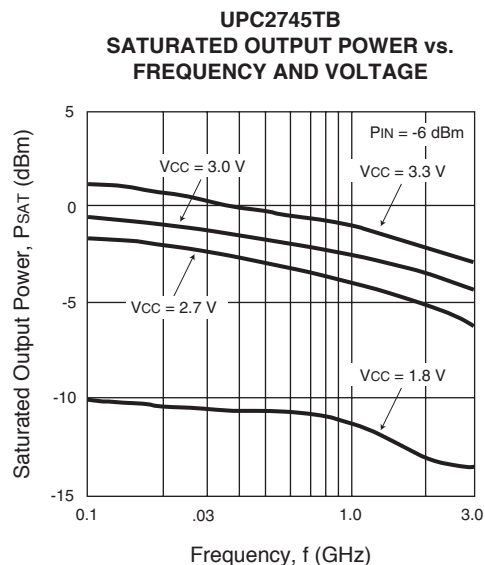
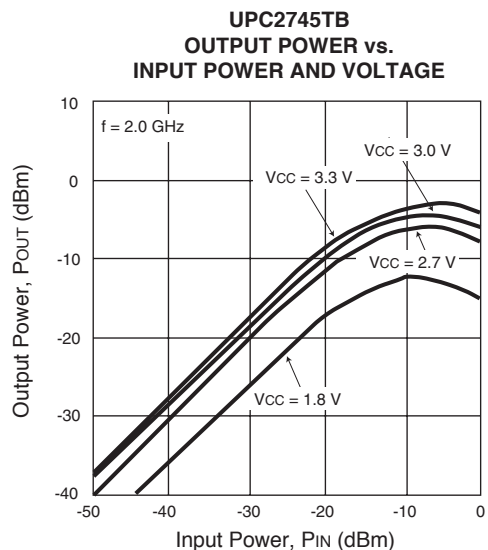
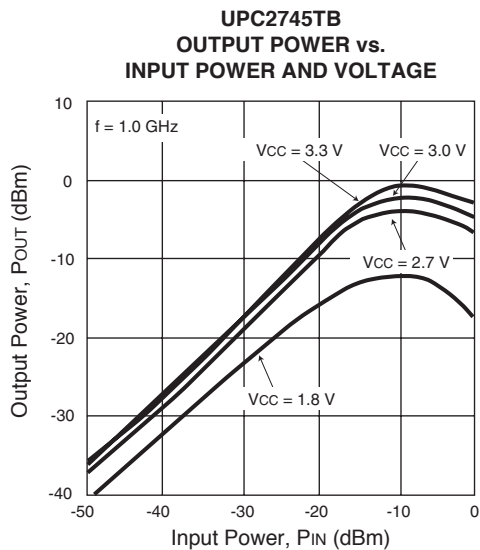
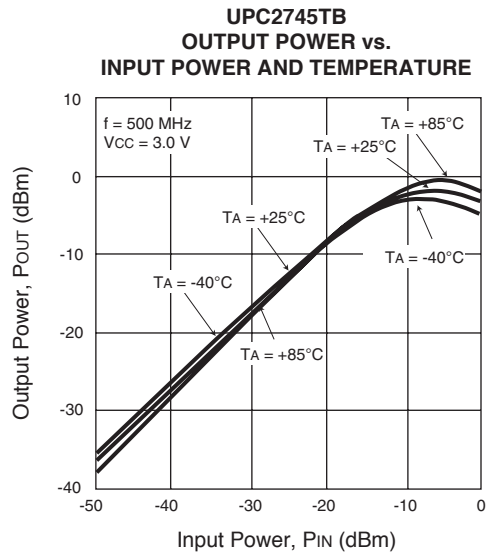
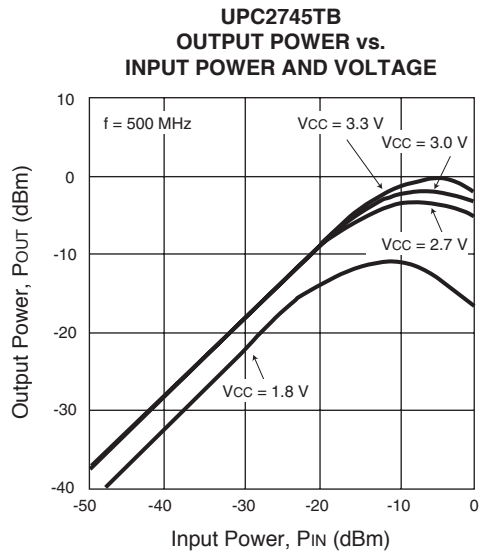

TYPICAL PERFORMANCE CURVES (TA = 25°C)

UPC2746TB
CURRENT vs. VOLTAGE

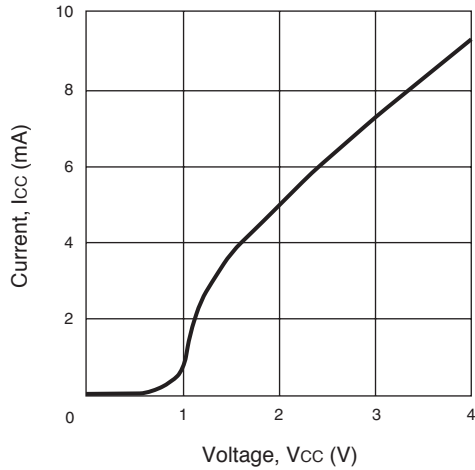

UPC2746TB
CURRENT vs. TEMPERATURE AND VOLTAGE

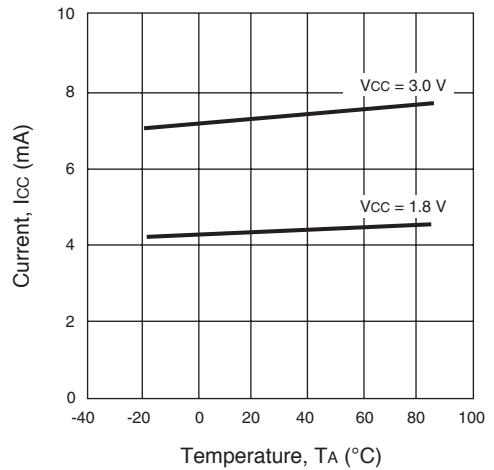

UPC2746TB
GAIN AND NOISE FIGURE vs.
FREQUENCY AND VOLTAGE

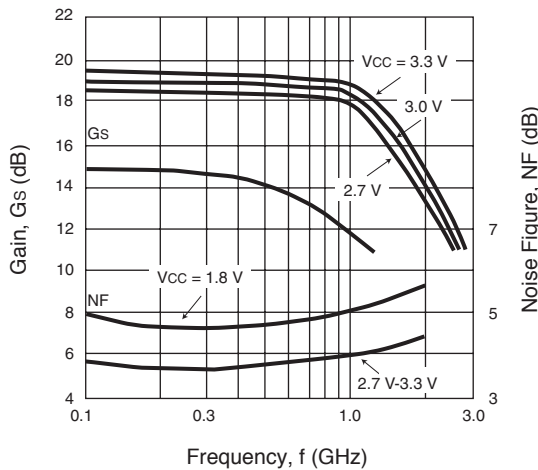

UPC2746TB
GAIN vs.
FREQUENCY AND TEMPERATURE

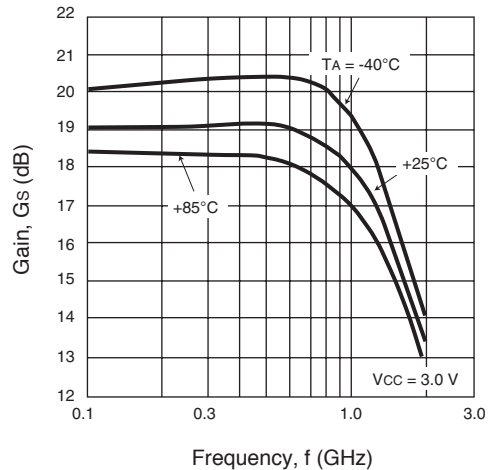

UPC2746TB
ISOLATION vs.
FREQUENCY AND VOLTAGE

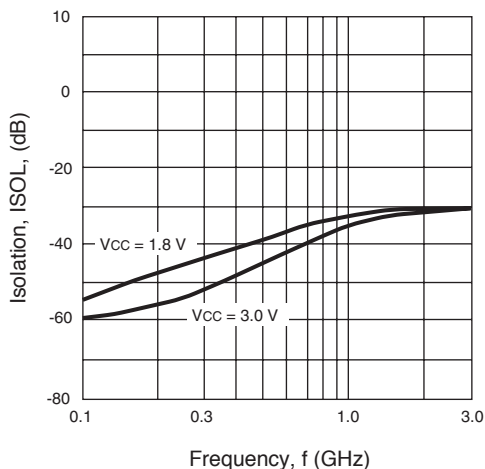

UPC2746TB
INPUT RETURN LOSS AND OUTPUT RETURN
LOSS vs. FREQUENCY AND VOLTAGE

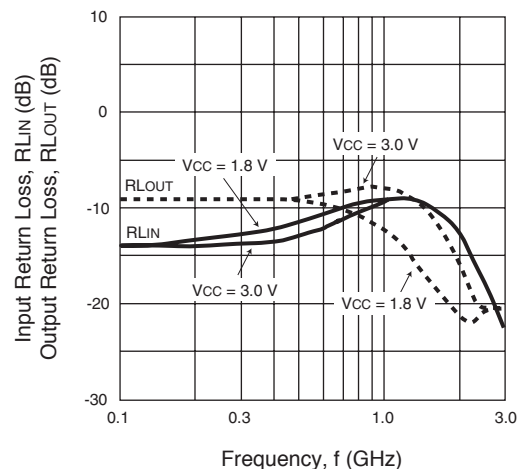

TYPICAL PERFORMANCE CURVES (TA = 25°C)

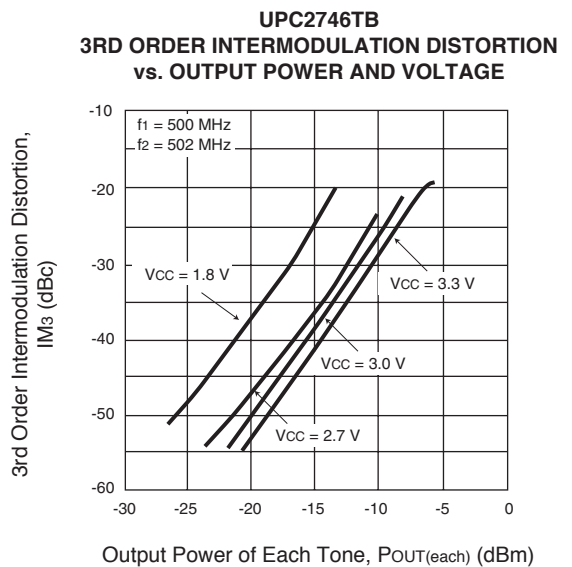
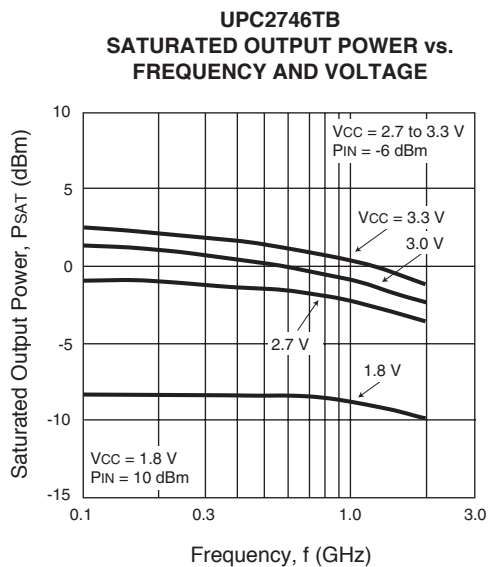
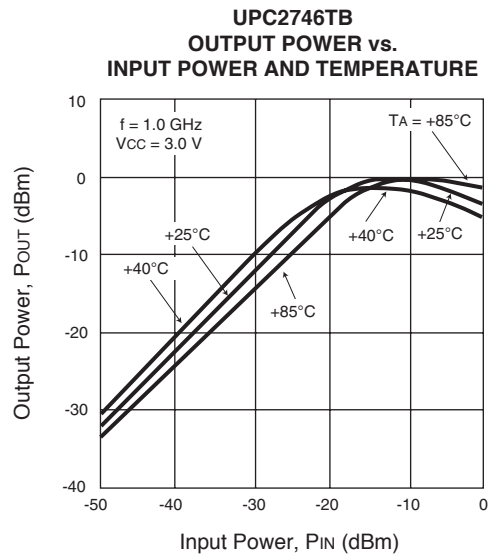
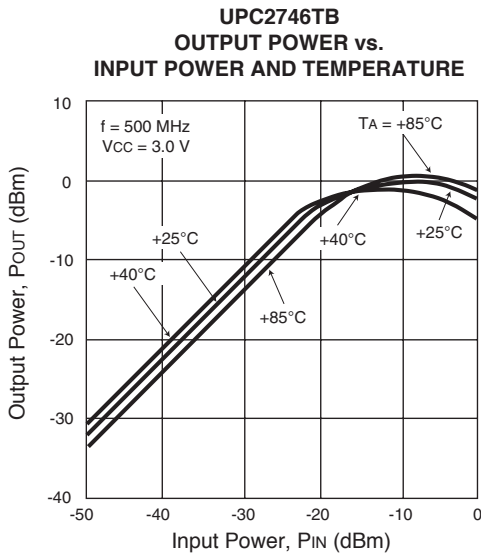
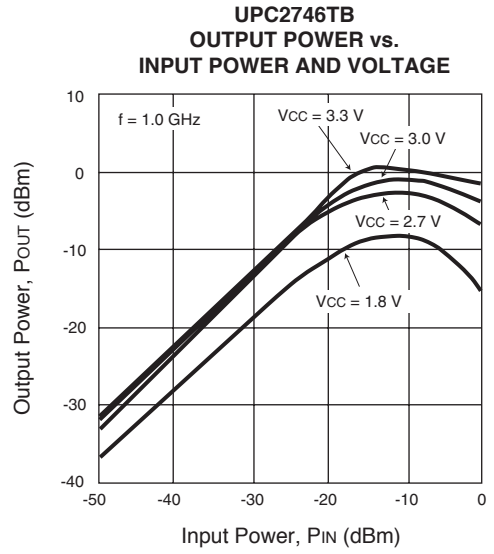
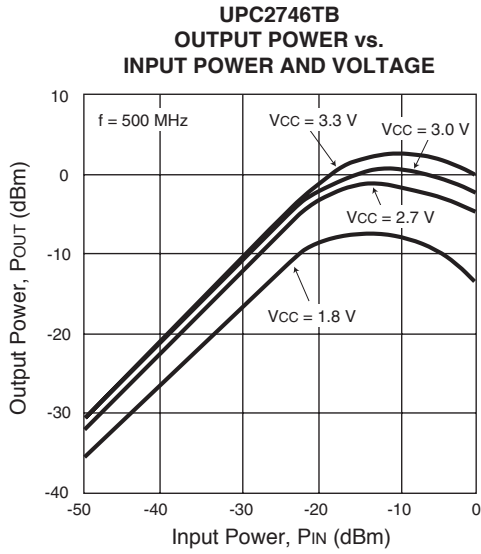

TYPICAL SCATTERING PARAMETERS ($T_A = 25^\circ\text{C}$)**UPC2745TB****V_{CC} = 3 V, I_{CC} = 8.4 mA**

FREQUENCY (MHz)	S ₁₁		S ₂₁		S ₁₂		S ₂₂		K
	MAG	ANG	MAG	ANG	MAG	ANG	MAG	ANG	
100.00	0.318	-3.90	4.055	-17.20	0.003	62.90	0.593	-6.60	20.94
200.00	0.325	-5.90	4.030	-35.50	0.006	54.20	0.584	-12.10	11.68
300.00	0.346	-7.20	3.985	-52.50	0.009	42.00	0.579	-16.50	8.29
400.00	0.341	-8.90	3.916	-70.70	0.012	29.40	0.562	-20.60	6.26
500.00	0.339	-10.80	3.842	-87.30	0.013	11.80	0.546	-23.00	6.29
600.00	0.326	-13.90	3.775	-104.70	0.015	1.60	0.527	-26.20	5.50
700.00	0.311	-20.80	3.668	-121.50	0.017	-11.90	0.515	-29.90	5.46
800.00	0.312	-25.80	3.594	-138.10	0.018	-24.20	0.511	-32.40	5.36
900.00	0.325	-31.90	3.525	-154.20	0.020	-38.40	0.512	-34.80	4.91
1000.00	0.356	-32.80	3.497	-170.30	0.019	-45.90	0.523	-35.80	4.93
1100.00	0.382	-32.70	3.503	173.70	0.020	-54.30	0.525	-36.30	4.56
1200.00	0.416	-31.20	3.542	156.70	0.022	-70.50	0.530	-36.80	4.14
1300.00	0.416	-30.90	3.569	139.10	0.023	-78.40	0.518	-37.50	3.92
1400.00	0.415	-30.80	3.520	121.40	0.025	-88.40	0.509	-38.80	3.53
1500.00	0.393	-30.30	3.501	103.70	0.025	-102.90	0.492	-40.50	3.68
1600.00	0.386	-31.30	3.429	86.80	0.025	-114.10	0.481	-42.50	3.78
1700.00	0.373	-30.50	3.355	69.70	0.026	-125.70	0.474	-43.80	3.68
1800.00	0.369	-31.60	3.303	52.70	0.028	-130.30	0.468	-44.80	3.50
1900.00	0.366	-29.60	3.229	35.80	0.028	-142.50	0.457	-44.80	3.63
2000.00	0.353	-30.00	3.179	18.80	0.030	-152.40	0.440	-45.00	3.62
2100.00	0.344	-28.60	3.081	1.50	0.031	-164.90	0.416	-45.00	3.85
2200.00	0.313	-29.50	2.999	-15.40	0.031	-177.10	0.389	-45.40	4.23
2300.00	0.293	-31.60	2.911	-32.50	0.033	171.10	0.365	-46.40	4.23
2400.00	0.267	-35.10	2.802	-49.40	0.034	160.80	0.346	-47.40	4.40
2500.00	0.262	-39.90	2.695	-66.00	0.036	148.30	0.331	-48.20	4.45
2600.00	0.253	-40.30	2.598	-82.30	0.036	134.80	0.321	-48.30	4.54
2700.00	0.253	-40.90	2.496	-98.60	0.034	121.40	0.311	-47.60	5.08
2800.00	0.248	-35.50	2.400	-114.60	0.036	106.50	0.299	-46.70	5.01
2900.00	0.237	-30.20	2.306	-130.20	0.032	92.80	0.279	-46.30	5.88
3000.00	0.230	-20.60	2.209	-146.60	0.031	83.60	0.254	-46.20	6.49

UPC2746TB**V_{CC} = 3 V, I_{CC} = 7.7 mA**

FREQUENCY (MHz)	S ₁₁		S ₂₁		S ₁₂		S ₂₂		K
	MAG	ANG	MAG	ANG	MAG	ANG	MAG	ANG	
100.00	0.146	165.00	6.443	-19.40	0.001	77.00	0.403	-5.30	108.63
200.00	0.130	141.70	6.594	-38.70	0.003	51.80	0.406	-8.60	20.56
300.00	0.117	117.90	6.623	-58.10	0.004	47.70	0.418	-11.10	16.33
400.00	0.128	100.80	6.522	-77.55	0.005	51.10	0.417	-14.00	12.34
500.00	0.139	90.80	6.613	-96.90	0.008	33.10	0.424	-16.20	8.14
600.00	0.145	83.10	6.481	-116.10	0.009	21.70	0.422	-19.40	7.22
700.00	0.135	77.00	6.424	-135.10	0.010	14.70	0.426	-23.80	6.52
800.00	0.131	67.40	6.353	-153.60	0.011	-0.40	0.433	-27.70	5.63
900.00	0.119	49.30	6.234	-172.10	0.014	-10.50	0.442	-32.10	4.80
1000.00	0.142	30.40	6.137	169.60	0.015	-24.20	0.455	-34.70	4.44
1100.00	0.170	18.10	5.992	151.10	0.016	-28.70	0.455	-37.50	4.02
1200.00	0.219	10.60	5.972	133.30	0.019	-48.00	0.453	-39.70	3.49
1300.00	0.245	7.40	5.867	115.10	0.019	-63.40	0.433	-42.70	3.40
1400.00	0.268	3.10	5.679	97.00	0.022	-72.20	0.409	-45.50	3.16
1500.00	0.270	1.50	5.582	79.10	0.021	-86.90	0.375	-48.30	3.38
1600.00	0.268	-3.90	5.380	61.80	0.022	-99.60	0.349	-49.90	3.36
1700.00	0.258	-7.80	5.122	44.50	0.024	-110.70	0.318	-50.00	3.42
1800.00	0.251	-14.30	4.880	27.90	0.024	-122.90	0.294	-49.20	3.67
1900.00	0.249	-16.70	4.634	11.70	0.025	-135.30	0.268	-45.40	3.73
2000.00	0.240	-20.50	4.475	-4.40	0.026	-146.00	0.248	-40.50	3.91

SYSTEM APPLICATION EXAMPLE

PCS

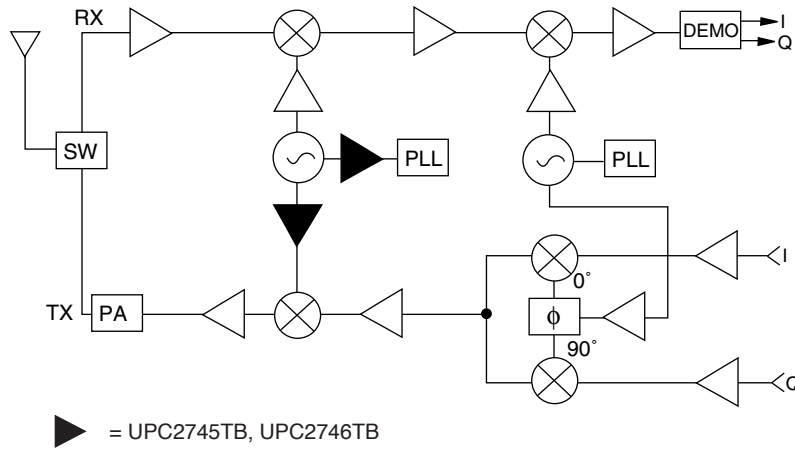

OUTLINE DIMENSIONS (Units in mm)

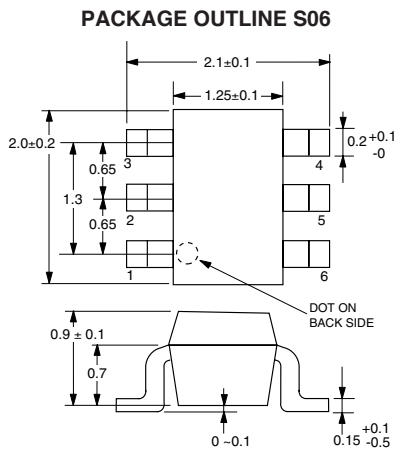

PIN CONNECTIONS

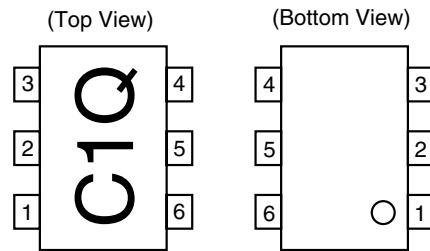

Marking is an example of UPC2745TB

- 1. Input
- 2. GND
- 3. GND
- 4. Output
- 5. GND
- 6. Vcc

TEST CIRCUIT

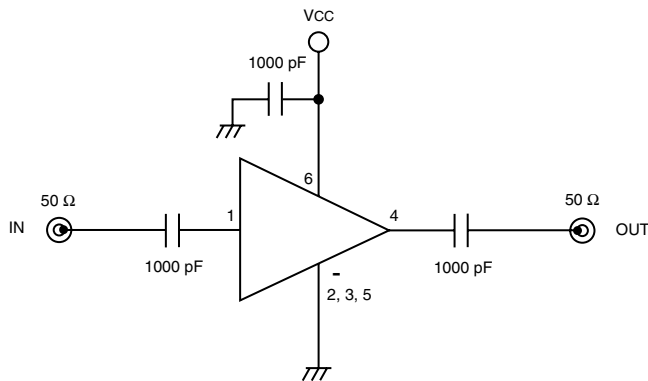

Life Support Applications

These NEC products are not intended for use in life support devices, appliances, or systems where the malfunction of these products can reasonably be expected to result in personal injury. The customers of CEL using or selling these products for use in such applications do so at their own risk and agree to fully indemnify CEL for all damages resulting from such improper use or sale.

ORDERING INFORMATION

PART NUMBER	MARKING	QTY
UPC2745TB-E3-A	C1Q	3 K/reel
UPC2746TB-E3-A	C1R	3 K/reel

Note: Embossed tape, 8 mm wide. Pins 1, 2, and 3 face perforated side of tape.

EXCLUSIVE NORTH AMERICAN AGENT FOR **NEC** RF, MICROWAVE & OPTOELECTRONIC SEMICONDUCTORS

CEL CALIFORNIA EASTERN LABORATORIES • Headquarters • 4590 Patrick Henry Drive • Santa Clara, CA 95054-1817 • (408) 988-3500 • Telex 34-6393 • FAX (408) 988-0279
24-Hour Fax-On-Demand: 800-390-3232 (U.S. and Canada only) • Internet: <http://WWW.CEL.COM>

Subject: Compliance with EU Directives

CEL certifies, to its knowledge, that semiconductor and laser products detailed below are compliant with the requirements of European Union (EU) Directive 2002/95/EC Restriction on Use of Hazardous Substances in electrical and electronic equipment (RoHS) and the requirements of EU Directive 2003/11/EC Restriction on Penta and Octa BDE.

CEL Pb-free products have the same base part number with a suffix added. The suffix –A indicates that the device is Pb-free. The –AZ suffix is used to designate devices containing Pb which are exempted from the requirement of RoHS directive (*). In all cases the devices have Pb-free terminals. All devices with these suffixes meet the requirements of the RoHS directive.

This status is based on CEL’s understanding of the EU Directives and knowledge of the materials that go into its products as of the date of disclosure of this information.

Restricted Substance per RoHS	Concentration Limit per RoHS (values are not yet fixed)	Concentration contained in CEL devices	
		-A	-AZ
Lead (Pb)	< 1000 PPM	Not Detected	(*)
Mercury	< 1000 PPM	Not Detected	
Cadmium	< 100 PPM	Not Detected	
Hexavalent Chromium	< 1000 PPM	Not Detected	
PBB	< 1000 PPM	Not Detected	
PBDE	< 1000 PPM	Not Detected	

If you should have any additional questions regarding our devices and compliance to environmental standards, please do not hesitate to contact your local representative.

Important Information and Disclaimer: Information provided by CEL on its website or in other communications concerning the substance content of its products represents knowledge and belief as of the date that it is provided. CEL bases its knowledge and belief on information provided by third parties and makes no representation or warranty as to the accuracy of such information. Efforts are underway to better integrate information from third parties. CEL has taken and continues to take reasonable steps to provide representative and accurate information but may not have conducted destructive testing or chemical analysis on incoming materials and chemicals. CEL and CEL suppliers consider certain information to be proprietary, and thus CAS numbers and other limited information may not be available for release.

In no event shall CEL’s liability arising out of such information exceed the total purchase price of the CEL part(s) at issue sold by CEL to customer on an annual basis.

See CEL Terms and Conditions for additional clarification of warranties and liability.