



Product Specification

DL (DIN Rail) Series

10W-480W Power Supplies

707151 Rev 08-28-17

Notices

N2Power™, a division of Qualstar Corporation.

N2Power and the *N2Power* logo are registered trademarks of Qualstar Corporation.

Copyright© 2014 - 2017 by Qualstar Corporation — All Rights Reserved

For warranty information refer to www.n2power.com

Information contained in this document is copyrighted by Qualstar Corporation and is intended for use by customers and prospective customers to evaluate and integrate our power supplies. Customers and prospective customers may reproduce this document as needed for these purposes. Reproduction in whole or in part for any other purpose or by any other party is prohibited without prior written permission from Qualstar Corporation.

Every effort has been made to keep the information contained in this document current and accurate as of the date of publication or revision. However, no guarantee is given or implied that the document is error-free or that it is accurate with regard to any specification. *N2Power* reserves the right to modify the design or specification without notice.

This specification may not be construed as a contractual obligation except as specifically agreed to by *N2Power* in writing at the time of order.

For information about this product specification, please write or call *N2Power* at:

N2Power

130 W. Cochran St., Suite C
Simi Valley, CA 93065

FAX: (805) 583-7749
Phone: (805) 583-7744

E-Mail: sales@n2power.com
www.n2power.com

Table of Contents

1.	Introduction.....	1-1
1.1	Introduction.....	1-1
1.2	Agency Compliance.....	1-2
2.	AC Input.....	2-1
2.1	Input Line Requirements.....	2-1
2.2	Input Over Current Protection.....	2-1
2.3	Inrush Current Limiting.....	2-1
2.4	Low Input Voltage.....	2-1
2.5	Leakage Current.....	2-1
3.	DC Outputs.....	3-1
3.1	Output Voltage Regulation.....	3-1
3.2	No Load Operation.....	3-2
3.3	Output Ripple/Noise.....	3-5
3.4	Redundant Operation: DLRDM20.....	3-7
3.5	Output Protection.....	3-7
3.6	Output Rise Time.....	3-9
3.7	Overshoot at Turn On/Turn Off.....	3-9
4.	General Specifications.....	4-1
4.1	Environmental.....	4-1
4.2	Mean Time Between Failures.....	4-1
4.3	Labeling/Marking.....	4-2
4.4	Net Weight.....	4-2
4.5	Mounting.....	4-3
4.6	Physical Dimensions.....	4-3
4.7	Wiring Terminals.....	4-4
4.8	Output Grounding.....	4-4
4.9	Signal Pin Definitions.....	4-5
5.	Efficiency.....	5-1
6.	Signals.....	6-1
6.1	DC_OK.....	6-1
6.2	DC OK LED.....	6-1
6.3	Voltage Hold-Up Time.....	6-1
7.	Ordering Information.....	7-1

1.

Introduction

1.1 Introduction

This specification defines the DL series of DIN Rail, universal input, single output, power factor corrected 10W-480W switch mode power supplies. It includes information regarding the mechanical details, cooling requirements, electrical and signal specifications, and environmental ranges for storage and operation of the power supply. These supplies achieve very high packaging densities and air convection cooling. They range in size from 0.91 x 3.90 x 3.54 to 3.90 x 4.86 x 4.92. All of the DL family models are listed in Table 3-1.

All models of the DL Series can be used as standalone power supplies. Available as an accessory, a single-output model DLRDM20 provides internal OR-ing diodes so that up to 3 24V power supplies may be connected in parallel for redundant or N+1 configurations.



Figure 1-1 DL Series (models differ slightly)

1.2 Agency Compliance





Safety	Complies with Standard	Remarks
United States and Canada	UL 508 (Industrial Control Equipment) listed	
United States	UL 1310 Class 2 Power Supply	DL10 ~ DL100 series (10W ~ 100W Din Rail Power Supply)
European	EN 60950-1:2006+A11	
Dielectric Withstand Voltage	I/P-O/P: 4242Vdc; I/P-GND: 2121Vdc 1 minute	
Isolation Resistance	I/P-O/P, I/P-FG, O/P-FG: > 100MΩ/500Vdc	
EMC	Complies with Standard	Remarks
RFI Emission	EN 55022: 2006 Class B EN 61204-3: 2000 EN 61000-6-3: 2007 EN 61000-3-2: 2006 Class A EN 61000-3-3: 1995+A1:2001+A2: 2005	Emission Standard Limits for harmonic current emission Limitation of voltage fluctuations and flicker in low-voltage supply system
Immunity:	EN 55024: 1998+A1:2001_A2:2003 EN 61204-3: 2000 EN 61000-6-1: 2007 IEC 61000-4-2 IEC 61000-4-3 IEC 61000-4-4 IEC 61000-4-5 IEC 61000-4-6 IEC 61000-4-8 IEC 61000-4-11	Immunity standard Electrostatic discharge immunity Radio frequency immunity Electrical fast transient burst immunity Power line surge immunity RF common mode immunity Power frequency magnetic field immunity Voltage dips and short interruptions immunity
Reduction of Hazardous Substances (RoHS)	Complies with Standard	Remarks
EU Council	2002/95/EC 2011/65/EU	RoHS Directive RoHS 2 Directive
Marks of Conformance		
United States & Canada	 	IND. CONT. EQ. Underwriters Laboratories File E469384 (E469382 Class 2)
TUV		
EU Council		

Table 1-1 Agency Compliance

2.1 Input Line Requirements

The following table defines the voltage and frequency requirements for the AC line inputs to the DIN Rail models which are capable of supplying full rated power in continuous operation throughout the specified ranges of voltages and frequencies. The power supply will automatically recover from AC power loss and is capable of starting under maximum load at the minimum AC input voltage described below.

Parameter	Minimum	Nominal	Maximum
RMS Input Voltage	88VAC	100–240VAC	264VAC
RMS Input Current	–	–	1.8A @ 100V 0.8A @ 240V
Input Frequency	47Hz	50/60Hz	63Hz

Table 2-1 DIN Rail Input Parameters

2.2 Input Over Current Protection

The DIN Rail series incorporates a primary AC line fuse for input over current protection to prevent damage to the power supply and meet product safety requirements as outlined in Section 1.2.

2.3 Inrush Current Limiting

The cold start inrush current is limited to 30A peak at 115VAC and 60A at 230VAC. Repetitive ON/OFF cycling of the AC input voltage shall not damage the power supply or cause the input fuse to fail.

2.4 Low Input Voltage

The application of an input voltage below the minimums specified in Table 2-1 shall not cause damage to the power supply.

2.5 Leakage Current

The leakage current from AC line or AC Neutral inputs to Earth Ground is <1Ma/230Vac.

3.

DC Outputs

3.1 Output Voltage Regulation

The DC output voltages shall remain within the Minimum and Maximum limits of Table 3-1 when measured at the power supply connector under all specified line, load and environmental conditions contained herein. The main output (V1) in the single output models (-12 thru -48V).

Model	Output	Rated Voltage	Regulation	Minimum (VDC)	Nominal (VDC)	Maximum (VDC)
DL10-12	V1	12	±1%	11.88	12.00	12.12
DL10-15	V1	15	±1%	13.85	15.00	15.15
DL10-24	V1	24	±1%	23.76	24.00	24.24
DL20-12	V1	12	±1%	11.88	12.00	12.12
DL20-15	V1	15	±1%	13.85	15.00	15.15
DL20-24	V1	24	±1%	23.76	24.00	24.24
DL40-12	V1	12	±1%	11.88	12.00	12.12
DL40-15	V1	15	±1%	13.85	15.00	15.15
DL40-24	V1	24	±1%	23.76	24.00	24.24
DL40-48	V1	48	±1%	47.52	48.00	48.48
DL60-12	V1	12	±1%	11.88	12.00	12.12
DL60-15	V1	15	±1%	13.85	15.00	15.15
DL60-24	V1	24	±1%	23.76	24.00	24.24
DL60-48	V1	48	±1%	47.52	48.00	48.48
DL100-12	V1	12	±1%	11.88	12.00	12.12
DL100-15	V1	15	±1%	13.85	15.00	15.15
DL100-24	V1	24	±1%	23.76	24.00	24.24
DL100-48	V1	48	±1%	47.52	48.00	48.48
DL150-24	V1	24	±1%	23.76	24.00	24.24
DL150-48	V1	48	±1%	47.52	48.00	48.48
DL240-24	V1	24	±1%	23.76	24.00	24.24
DL240-48	V1	48	±1%	47.52	48.00	48.48
DL480-24	V1	24	±1%	23.76	24.00	24.24
DL480-48	V1	48	±1%	47.52	48.00	48.48

Table 3-1 DL Output Voltage Specifications

3.2 No Load Operation

The power supply will operate under a no load condition and will not result in damage to the supply. The power supply will remain stable and operate normally after application of loads.

3.2.1 Output Loading for Single Output Models

The output currents listed in Table 3-2 require natural convection cooling at no more than 50°C.

Model	Rated V1 Output	Maximum Convection Load
DL10-12	12V	0.84A
DL10-15	15V	0.67A
DL10-24	24V	0.42A
DL20-12	12V	1.7A
DL20-15	15V	1.4A
DL20-24	24V	1.0A
DL40-12	12V	3.4A
DL40-15	15V	2.7A
DL40-24	24V	1.7A
DL40-48	48V	0.85A
DL60-12	12V	5.0A
DL60-15	15V	4.0A
DL60-24	24V	2.5A
DL60-48	48V	1.25A
DL100-12	12V	7.5A
DL100-15	15V	6.4A
DL100-24	24V	4.0A
DL100-48	48V	2.0A
DL150-24	24V	6.3A
DL150-48	48V	3.2A
DL240-24	24V	10.0A
DL240-48	48V	5.0A
DL480-24	24V	20.0A
DL480-48	48V	10.0A
DLRDM20	24V	20.0V

Table 3-2 Max Load Currents Single Output Models

3.2.2 High Temperature Derating

The DL series can be operated at elevated temperatures by derating the total maximum output power (or current) by 2.5%/°C from 50°C to 70°C.

Load vs. Temp.

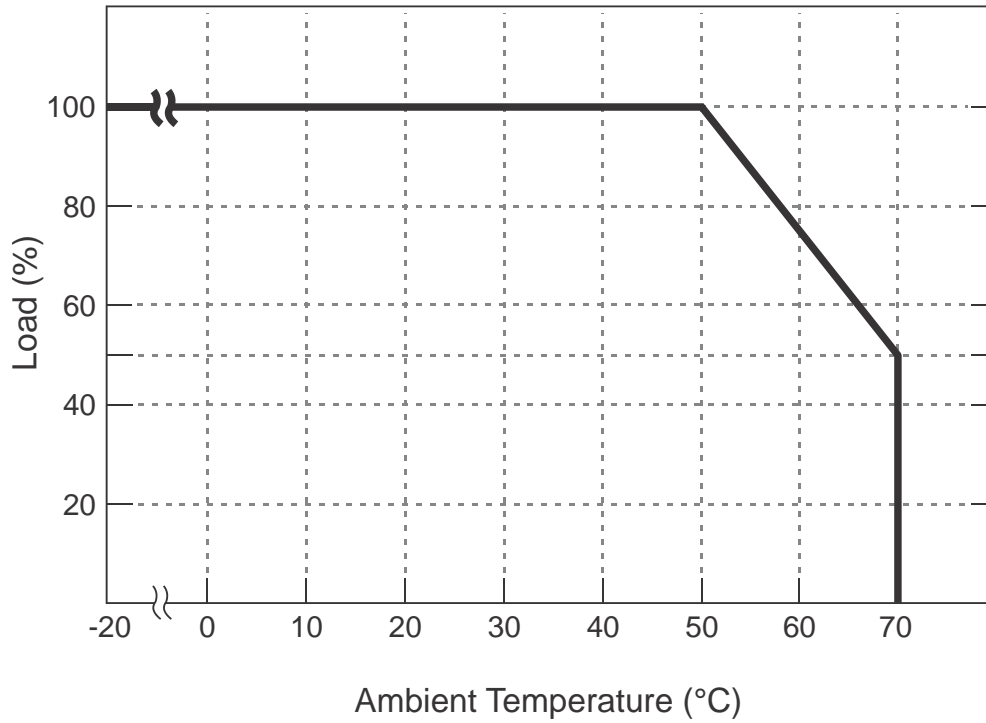

Figure 3-1 Derating Curve: Models DL10 thru DL100 Series

Load vs. I/P Voltage

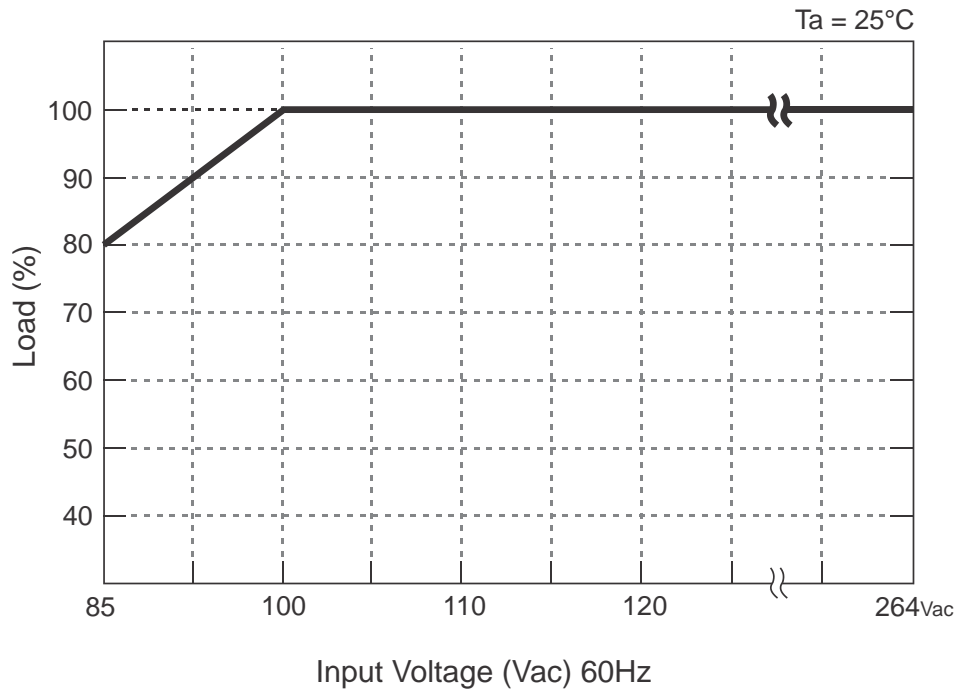

Figure 3-2 Load vs. Input Voltage: DL10 thru DL100 Series

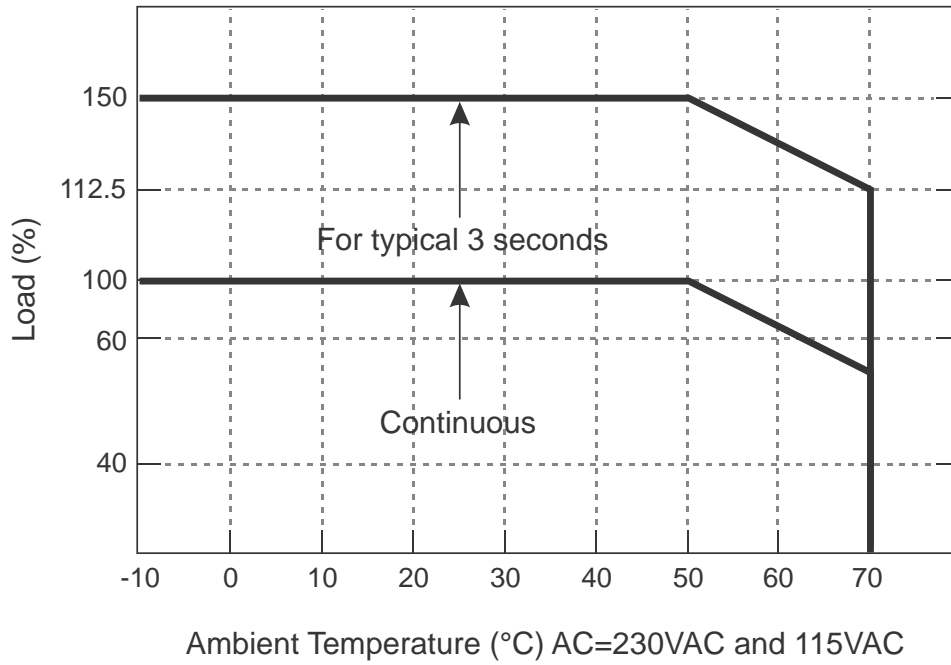

Figure 3-3 Derating Curve: Models DL150, DL240 and DL480 Series

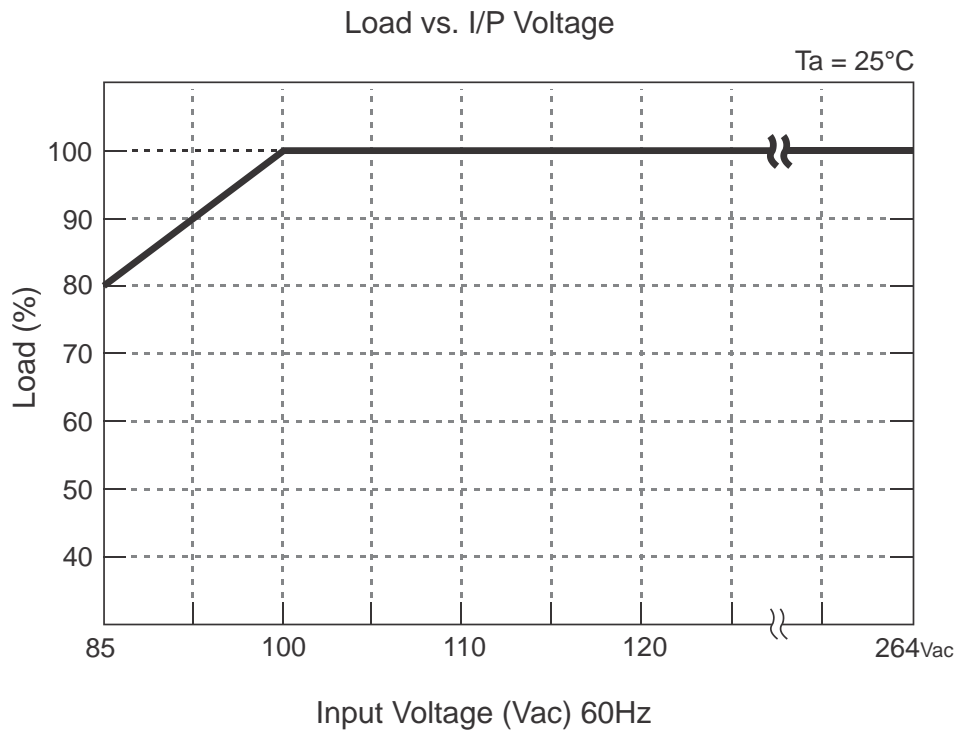

Figure 3-4 Load vs. Input Voltage: Models DL150, DL240 and DL480 Series

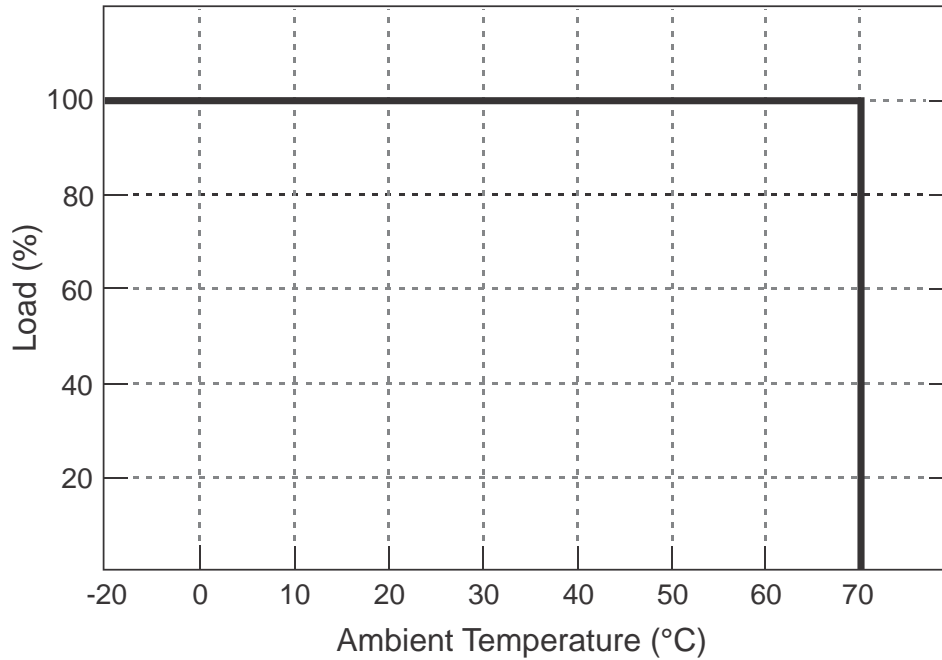

Figure 3-5 DLRDM20 Derating Curve

3.3 Output Ripple/Noise

Output ripple voltage and noise are measured at 20MHz of bandwidth by using a 12” twisted pair-wire terminated with a 0.1uf & 47uf parallel. The ripple noise is measured from the output pin connectors (V+ and V-).

3.3.1 Ripple/Noise Limits: DIN Rail Models (DL10 through DL480)

The ripple voltage of the outputs is measured at the pins of the mating connector. Ripple and noise shall not exceed the limits specified in Table 3-3 under any condition of line voltage and frequency specified in Section 2.1 and DC loading specified in Section 3.2.1.

Model	Output	Voltage	Maximum Ripple+Noise (peak-to-peak)
DL10-12	V1	12V	100mV
DL10-15	V1	15V	100mV
DL10-24	V1	24V	120mV
DL20-12	V1	12V	100mV
DL20-15	V1	15V	100mV
DL20-24	V1	24V	120mV
DL40-12	V1	12V	100mV
DL40-15	V1	15V	100mV
DL40-24	V1	24V	120mV

Model	Output	Voltage	Maximum Ripple+Noise (peak-to-peak)
DL40-48	V1	48V	180mV
DL60-12	V1	12V	100mV
DL60-15	V1	15V	100mV
DL60-24	V1	24V	120mV
DL60-48	V1	48V	180mV
DL100-12	V1	12V	180mV
DL100-15	V1	15V	180mV
DL100-24	V1	24V	180mV
DL100-48	V1	48V	250mV
DL150-24	V1	24V	240mV
DL150-48	V1	48V	480mV
DL240-24	V1	24V	150mV
DL240-48	V1	48V	300mV
DL480-24	V1	24V	240mV
DL480-48	V1	48V	480mV

Table 3-3 Ripple Voltage: DL Output Models (DL10 through DL480)

3.3.2 Ripple/Noise Test Setup

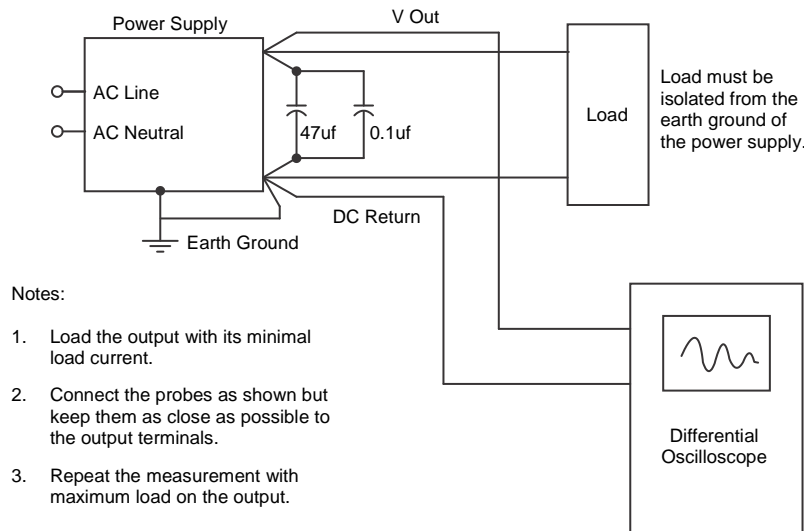

Figure 3-6 Ripple Noise Measurement Setup

3.4 Redundant Operation: DLRDM20

Three of the DLRDM20 accessories may be connected in parallel to provide higher output power and greater reliability for redundant or N+1 configurations.

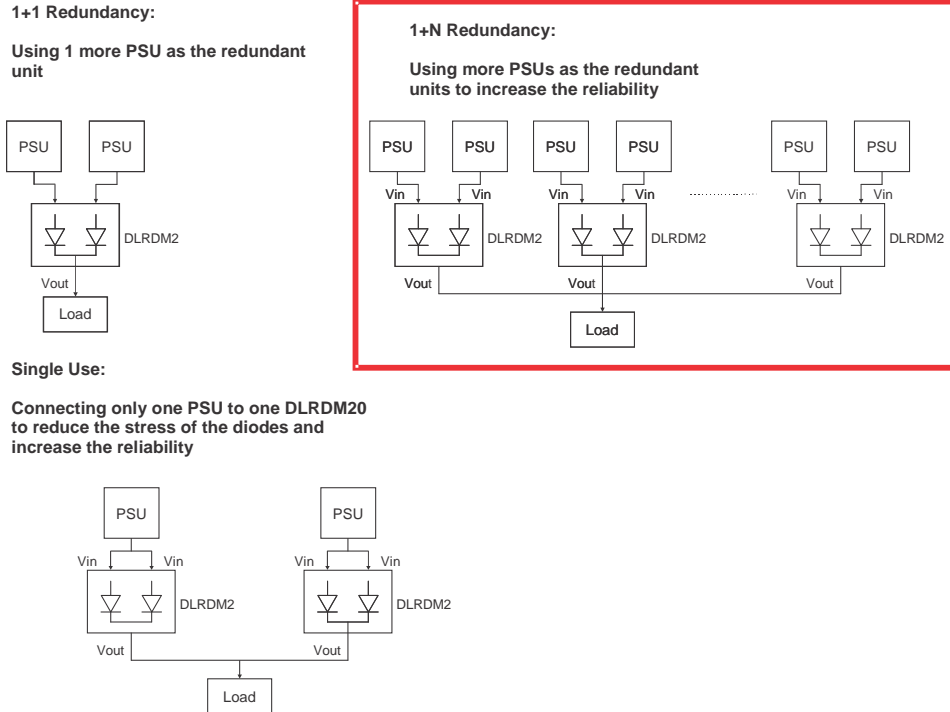

Figure 3-7 DLRDM20 Typical Applications

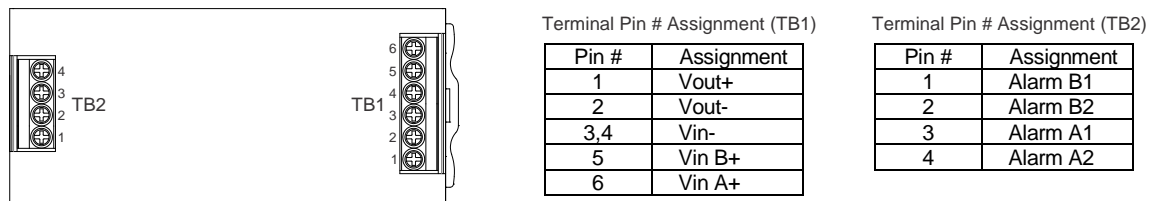

Figure 3-8 DLRDM20 Terminal Block Pin Assignments

3.5 Output Protection

There are three different output protection schemes designed to protect the load and the DL Series from component failures and extraordinary circumstances.

3.5.1 Over Temperature Protection (OTP)

If the DL Series is operated without adequate cooling, it will sense an over-temperature condition 95°C +/- 5°C and shut itself down. It will not restart until it

has cooled down to below its maximum operating temperature and the AC power is turned off and back on. The DLRDM20 does not have over temperature protection and this redundancy module will become defective in over temperature condition.

3.5.2 Over Voltage Protection (OVP)

No single fault is able to cause a sustained over voltage condition on any output. When an over-voltage condition occurs, the power supply will shut down and will not restart until AC power is turned off and back on. The DIN Rail supply will latch –off under the following over voltage conditions:

Model	Minimum	Nominal	Maximum
DL10-12	13.80V	15.90V	18.00V
DL10-15	17.25V	19.75V	22.50V
DL10-24	27.60V	31.80V	36.00V
DL20-12	13.80V	15.90V	18.00V
DL20-15	17.25V	19.75V	18.00V
DL20-24	27.60V	31.80V	36.00V
DL40-12	13.80V	15.90V	18.00V
DL40-15	17.25V	19.75V	22.50V
DL40-24	27.60V	31.80V	36.00V
DL40-48	55.20V	63.60V	72.00V
DL60-12	13.80V	15.90V	18.00V
DL60-15	17.25V	19.75V	22.50V
DL60-24	27.60V	31.80V	36.00V
DL60-48	55.20V	63.80V	72.00V
DL100-12	13.80V	15.90V	18.00V
DL100-15	17.25V	19.75V	22.50V
DL100-24	27.60V	31.80V	36.00V
DL100-48	55.20V	63.60V	72.00V
DL150-24	29.00V	31.00V	33.00V
DL150-48	56.00V	60.50V	65.00V
DL240-24	28.00V	30.50V	33.00V
DL240-48	56.00V	60.50V	65.00V
DL480-24	29.00V	31.00V	33.00V
DL480-48	56.00V	60.50V	65.00V

Table 3-4 Over Voltage Protection Limits

3.5.3 Over Current Protection (OCP)

For model **DL150**: works within 105~150% rated output power for more than three seconds and then shutdown o/p voltage with auto-recovery, >150% rated power or short circuit is constant current limiting. If o/p drops to 40% rating output voltage the

supply will shut down and auto recover five times. If fault condition is not removed within these five times, the supply will latch off and requires a power cycle to recover.

For model **DL240**: >150%, rated power or short circuit is constant current limiting, If o/p drops to 40% rating output voltage the supply will shut down and auto recover five (5) times. If fault condition is not removed within these five (5) times, the supply will latch off and requires a power cycle to recover.

For model **DL480**: Hiccup mode: when the rated output power is within 105~150% for more than three seconds. Constant limit >150% rated power or short circuit. If o/p drops to 40% rating output voltage the supply will shut down and auto recover five times. If fault condition is not removed within these five times, the supply will latch off and requires a power cycle to recover.

3.5.4 Short Circuit Protection

A short circuit is defined as an impedance of less than 0.1 ohms placed between DC RETURN and any output. A short circuit will cause no damage to the power supply, but will cause it to shutdown. The power supply will periodically attempt a restart until the short circuit condition is removed. After successfully restarting, the power supply will operate normally.

3.6 Output Rise Time

All output voltages shall rise from 10% to 90% of nominal output voltage (as specified in Table 3-1) within 30ms to 100ms. The output voltages waveform must be a monotonic ramp from 10% to 90% of final setpoint within the regulation band under any loading conditions specified in the respective load current tables in Table 3-2.

For the purposes of this specification, a monotonic ramp is defined as always having a positive slope of from zero to $10 \times V_{out}$ volts/millisecond. During any 5-millisecond portion of the ramp, its slope must be greater than 5% of its rated voltage per millisecond.

3.7 Overshoot at Turn On/Turn Off

The DL10 through DL100 series do not support the overshoot feature. The DL150, DL240 and DL480 series support over and under overshoot $< \pm 5\%$.

4.

General Specifications

4.1 Environmental

The DL Series meets or exceeds the following environmental specifications:

Parameter	Conditions	Specification	Remarks
Temperature	Operating	-20°C to 70°C	DL10-100 Series, DLRDM20
		10°C to 70°C	DL150
		-25°C to 70°C	DL240, DL480
Relative Humidity	Non-Operating	-40°C to 85°C	
	Operating	90% Maximum	Non-Condensing
	Non-Operating	95% Maximum	Non-Condensing
Altitude	Operating	6,561 feet MSL Max.	2,000 meters
Vibration	No damage	2.0 G RMS Maximum	10-500Hz, 10-min/1cycle,60 min each along x, y, z axis. Mounting: Compliance to IEC60068-2-6

Table 4-1 Environmental Specifications

4.2 Mean Time Between Failures

The calculated MTBF of all models is equal to or greater than the specified hours of continuous operation at maximum output loading and worst-case input line voltage with convection cooling at 25°C. N2Power does not warrant the MTBF to be representative of any particular unit. The MTBF of the power supply is calculated with an 80% confidence level in accordance with (MIL-HDBK-217F). Actual failure rates vary from unit to unit.

Model	MTBF
DL10-12, -15 & -24	562.7K HRS
DL20-12	120.4K HRS
DL20-15	131.3K HRS
DL20-24	125.9K HRS
DL40-12, -15, 24 & -48	947.2K HRS
DL60-12, -15, 24 & -48	944.6K HRS
DL100-12, -15, 24 & -48	120.4K HRS
DL150-24 & -48	62.7K HRS
DL240-24 & -48	56.7K HRS
DL480-24 & -48	65.9K HRS
DLRDM20	TBD

Table 4-2 MTBF by Model

4.3 Labeling/Marking

The power supply is marked and labeled with the N2Power logo and part number, model number, input and output specifications, production code, appropriate safety agency logos and CE mark. Typical labels are pictured below.



Figure 4-1 Sample DL Label

4.4 Net Weight

Model:	DL10	DL20	DL40	DL60	DL100	DL150/240	DL480	DLRDM20
Pounds	0.34	0.36	0.72	0.76	0.99	2.35	3.30	1.21
Ounces	5.46	5.82	11.40	12.10	15.90	37.60	11.40	19.40
Kilograms	0.15	0.17	0.32	0.34	0.45	1.07	1.50	0.55

Table 4-3 DL Net Weights

4.5 Mounting

The DL power supplies may be mounted on DIN rail TS35/ 7.5 or 15.

4.6 Physical Dimensions

Unit : inch / mm

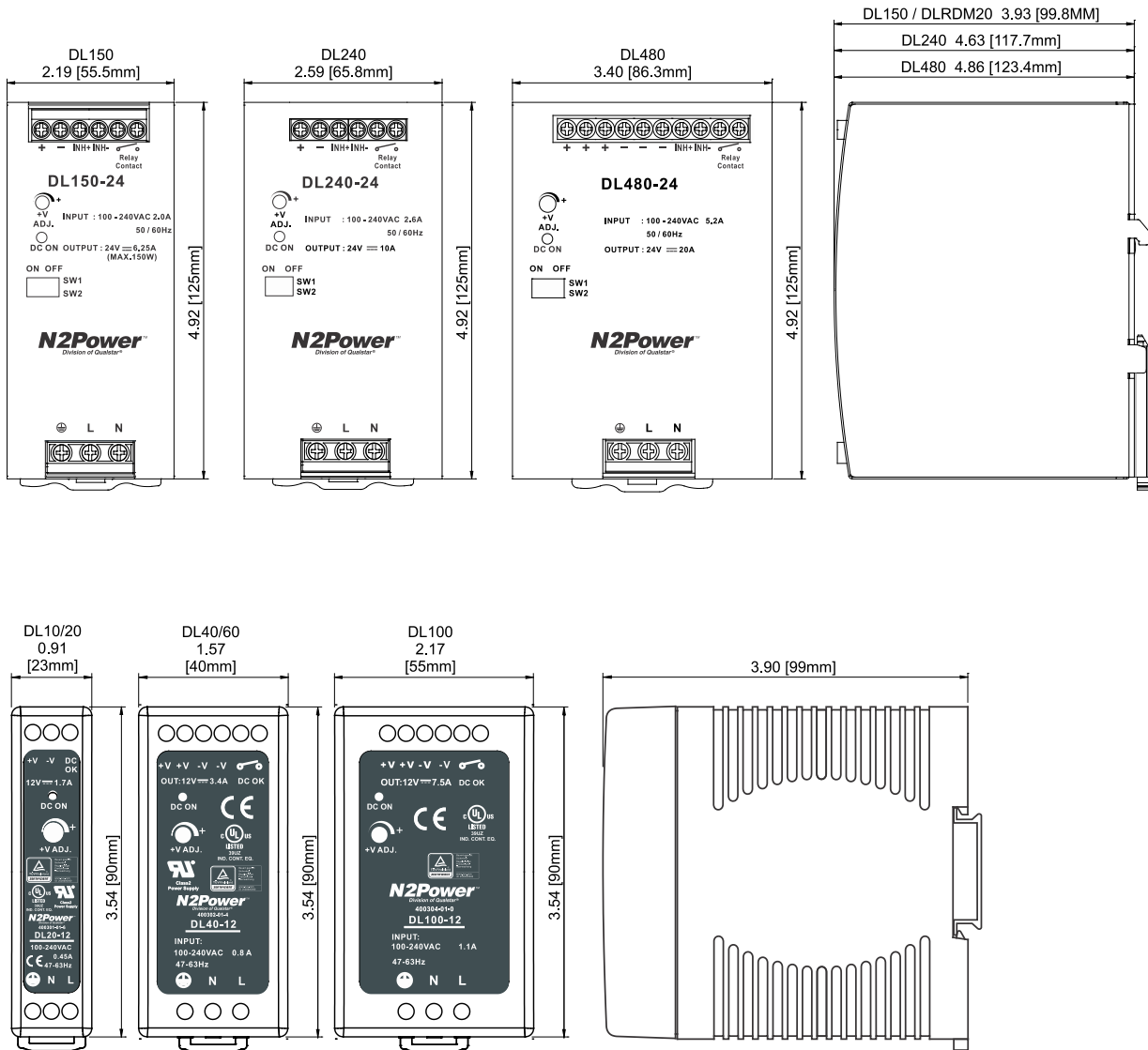

Figure 4-2 DL Dimensions

4.7 Wiring Terminals

The user must furnish all connectors. The DIN Rail input and output connectors use screw terminals.

Models	Wire Gauge for Terminals
DL10 thru DL100	12~24 AWG (IEC 0.5~2.5mm)
DL150 thru DL450	10~26 AWG (IEC 0.13~5.26mm)

Table 4-4 Wire Gauge for Terminals by Model

4.8 Output Grounding

The DC RETURN signal may be connected to the power supply chassis ground (safety earth) DIN Terminal next to the neutral AC line. See Figure 4-3.

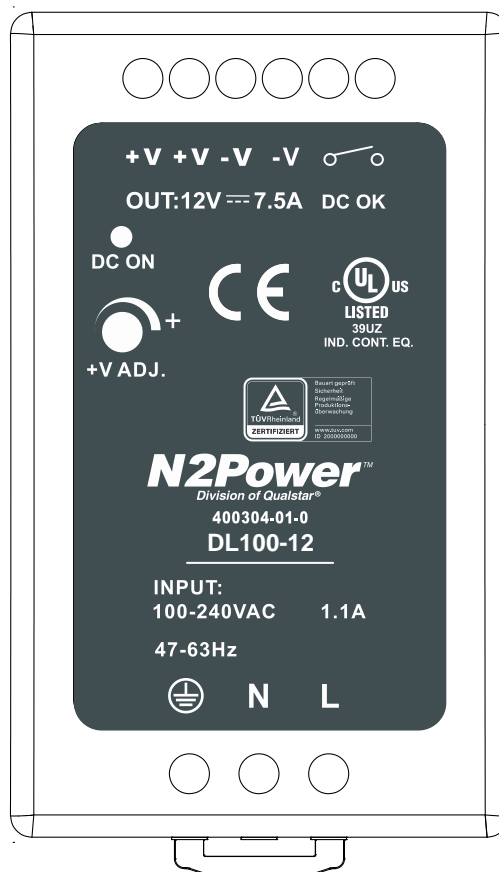
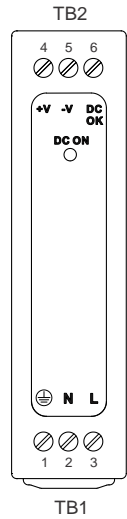

Figure 4-3 DL Ground Location

4.9 Signal Pin Definitions

- Signal pin definitions reside on the product labels on the front of the power supplies by the screw terminal connectors.
- Identical signal names are connected together on all connectors



Terminal Pin # Assignment (TB1)

Pin #	Assignment
1	FG
2	AC/N
3	AC/L

Terminal Pin # Assignment (TB2)

Pin #	Assignment
4	+DC
5	-DC
6	DC OK

Table 4-5 DL10 & DL20 Signal Pin Definitions

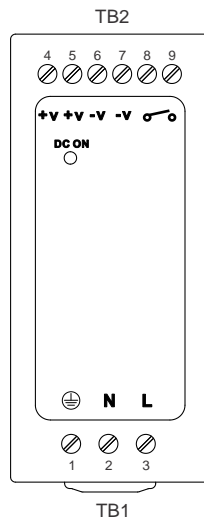

Terminal Pin # Assignment (TB1)

Pin #	Assignment
1	FG
2	AC/N
3	AC/L

Terminal Pin # Assignment (TB2)

Pin #	Assignment
4,5	+DC
6,7	-DC
8,9	DC OK

Table 4-6 DL40, DL60 & DL100 Signal Pin Definitions

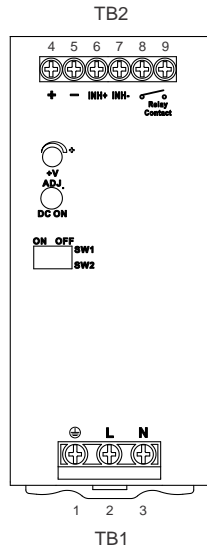

Terminal Pin # Assignment (TB1)

Pin #	Assignment
1	FG
2	AC/L
3	AC/N

Terminal Pin # Assignment (TB2)

Pin #	Assignment
1	+DC
2	-DC
3	INH+
4	INH-
5,6	Relay Contact

Switch # Assignment

SW #	Assignment
SW1	Peak Load Setting
SW2	Remote ON/OFF Setting

Table 4-7 DL150 & DL240 Signal Pin Definition

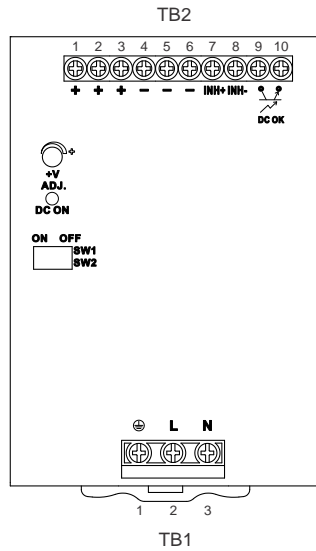

Terminal Pin # Assignment (TB1)

Pin #	Assignment
1	FG
2	AC/L
3	AC/N

Terminal Pin # Assignment (TB2)

Pin #	Assignment
1,2,3	+DC
4,5,6	-DC
7	INH+
8	INH-
9,10	DC OK

Switch # Assignment

SW #	Assignment
SW1	Peak Load Setting
SW2	Remote ON/OFF Setting

Table 4-8 DL480 Signal Pin Definitions

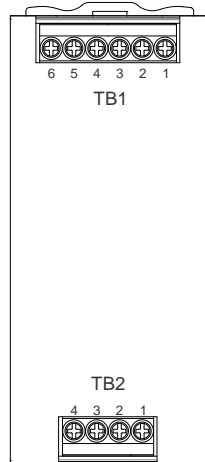

Terminal Pin # Assignment (TB1)

Pin #	Assignment
1	Vout+
2	Vout-
3,4	Vin-
5	Vin B+
6	Vin A+

Terminal Pin # Assignment (TB2)

Pin #	Assignment
1	Alarm B1
2	Alarm B2
3	Alarm A1
4	Alarm A2

Table 4-9 DLRDM20 Signal Pin Definitions

5.

Efficiency

The efficiencies for the DIN Rail power supplies are listed below. They were measured at full load, 25C, at 230AC.

DL:	Output	Load	AC	Efficiency
DL10	12V	0.84A	230VAC	81%
DL10	15V	0.67A	230VAC	81%
DL10	24V	0.42A	230VAC	81%
DL20	12V	1.7A	230VAC	83%
DL20	15V	1.4A	230VAC	85%
DL20	24V	1.0A	230VAC	86%
DL40	12V	3.4A	230VAC	84%
DL40	15V	2.7A	230VAC	84%
DL40	24V	1.7A	230VAC	84%
DL40	48V	0.85A	230VAC	85%
DL60	12V	5.0A	230VAC	86%
DL60	15V	4.0A	230VAC	87%
DL60	24V	2.5A	230VAC	87%
DL60	48V	1.25A	230VAC	88%
DL100	12V	7.5A	230VAC	87%
DL100	15V	6.4A	230VAC	87%
DL100	24V	4.0A	230VAC	88%
DL100	48V	2.0A	230VAC	87%
DL150	24V	6.3A	230VAC	87%
DL150	48V	3.2A	230VAC	87%
DL240	24V	10.0A	230VAC	91%
DL240	48V	5.0A	230VAC	92%
DL480	24V	20.0A	230VAC	93%
DL480	48V	10.0A	230VAC	94%

Table 5-1 DL Output Currents at Rated Efficiency

6.1 DC_OK

The DC_OK signal is the signal that is driven by an open-collector transistor. The electrical specifications for the DC_OK outputs are described in Table 6-1.

Signal Type	
Power On Delay	Models DL10 thru 100 <800ms Models DL150 and 240 <700ms Model DL480 <800ms
Rise Time	Models DL10 and 20 <100ms/230VAC at full load Models DL40 and 60 <50ms/230VAC at full load Model DL100 <40ms/230Vac at full load Models DL150 and 240 <30ms/230VAC/115VAC at full load Model DL480 <100ms/230VAC/115VAC at full load
PS DC_OK Output	Models DL10 and DL20 Open collector. Max:40mA. Model DL40 Relay contact (30VDC/1A,120VAC/1A) Models DL60 and DL100 Relay contact (24VDC/1A,120/1A) Models DL150 and DL240, 60Vdc/0.3A, 30VDC/1A, 30VAC/0.5A resistive load Model DL480, open collector signal

Table 6-1 DL Status and Control Signal Specifications

6.2 DC OK LED

A green LED on DL10-DL480 illuminates when DC-OK signal is true (high).

6.3 Voltage Hold-Up Time

The power supply will maintain output regulation per Table 3-1 despite a loss of input power. The Hold-Up Time is as follows:

Models	Hold-Up Time
DL10 thru DL100	16ms /115VAC at full load and >32ms/230VAC
DL150	16ms/115VAC at full load and 32ms/230VAC
DL240	22ms/115VAC at full load and 32ms/230VAC
DL480	16ms/115VAC at full load and 16ms/230V

Table 6-2 Hold-Up Time by Model

7.

Ordering Information

The following table provides the N2Power part numbers that should appear on your purchase order and will appear on any N2Power correspondence:

Model Number	V1	N2Power Part Number
DL10-12	12V	400300-01-8
DL10-15	15V	400300-02-6
DL10-24	24V	400300-03-4
DL20-12	12V	400301-01-6
DL20-15	15V	400301-02-4
DL20-24	24V	400301-03-2
DL40-12	12V	400302-01-4
DL40-15	15V	400302-02-2
DL40-24	24V	400302-03-0
DL40-48	48V	400302-04-8
DL60-12	12V	400303-01-2
DL60-15	15V	400303-02-0
DL60-24	24V	400303-03-8
DL60-48	48V	400303-04-6
DL100-12	12V	400304-01-0
DL100-15	15V	400304-02-8
DL100-24	24V	400304-03-6
DL100-48	48V	400304-04-4
DL150-24	24V	400305-01-7
DL150-48	48V	400305-02-5
DL240-24	24V	400306-01-5
DL240-48	48V	400306-02-3
DL480-24	24V	400307-01-3
DL480-48	48V	400307-02-1
DLRDM20	24V	400308-01-1

Table 7-1 DL Part Numbers

All DL power supplies are RoHS compliant For warranty information refer to www.n2power.com. Direct all questions, orders or requests for quotation as follows:

N2Power Order Desk: orders@n2power.com 805-583-7744 x112
Fax (Attention N2Power): 805-583-7749
Sales: sales@n2power.com 805-583-7744 x122
Technical Support: techsupport@n2power.com 805-583-7744 x119
Address: 130 W. Cochran St., Suite C, Simi Valley CA 93065