

**SF2198E**

**806 MHz  
SAW Filter**

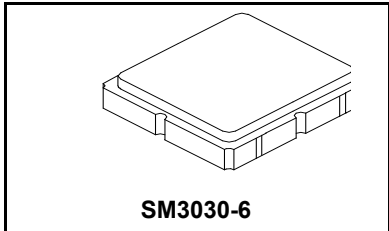

- Surface Mount 3.0 x 3.0 mm Package
- Complies with Directive 2002/95/EC (RoHS)



**Absolute Maximum Ratings**

Rating	Value	Units
Input Power Level	10	dBm
DC Voltage on any Non-ground Terminal	3	V
Operating Temperature Range	-40 to +85	°C
Storage Temperature Range in Tape and Reel	-40 to +85	°C
Maximum Soldering Profile, 5 cycles/10 seconds maximum	265	°C

**Electrical Characteristics**

Characteristic	Sym	Notes	Min	Typ	Max	Units
Center Frequency	$f_C$			806		MHz
Insertion Loss	IL	791 to 821 MHz		2.9	4.5	dB
		800 to 812 MHz		2.3	3.0	
		805 to 806 MHz		1.8	2.5	
Amplitude Ripple, 791 to 821 MHz				1.3	3.0	
VSWR, 791 to 821 MHz				1.7	2.5	
Attenuation, 0 dB Reference:						
DC to 760 MHz			45	55		dB
760 to 775 MHz			30	48		
832 to 862 MHz			8	15		
862 to 900 MHz			30	39		
900 to 1500 MHz			45	57		
1500 to 2000 MHz			35	45		
Source Impedance	$Z_S$			50		$\Omega$
Load Impedance	$Z_L$			50		
Case Style	SM3030-6 3.0 x 3.0 mm Nominal Footprint					
Lid Symbolization (Y=year, WW=week, S=shift) dot=pin 1 indicator	928, YWWS					
Standard Reel Quantity	Reel Size 7 Inch					500 Pieces/Reel
	Reel Size 13 Inch					3000 Pieces/Reel

**Electrical Connections**

Connection	Terminals
Input	2
Output	5
Case Ground	All others

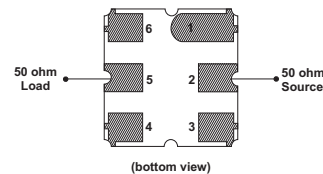

**CAUTION: Electrostatic Sensitive Device. Observe precautions for handling.**

**NOTES:**

1. Unless noted otherwise, all specifications apply over the operating temperature range with filter soldered to the specified demonstration board with impedance matching to 50  $\Omega$  and measured with 50  $\Omega$  network analyzer.
2. Unless noted otherwise, all frequency specifications are referenced to the nominal center frequency,  $f_C$ .
3. Rejection is measured as attenuation below the minimum IL point in the passband. Rejection in final user application is dependent on PCB layout and external impedance matching design. See Application Note No. 42 for details.
4. "LRIP" or "L" after the part number indicates "low rate initial production" and "ENG" or "E" indicates "engineering prototypes."
5. The design, manufacturing process, and specifications of this filter are subject to change.
6. Either Port 1 or Port 2 may be used for either input or output in the design. However, impedances and impedance matching may vary between Port 1 and Port 2, so that the filter must always be installed in one direction per the circuit design.
7. US and international patents may apply.
8. Murata, stylized Murata logo, and Murata N.A., Inc. are registered trademarks of Murata Manufacturing Co., Ltd.

# Filter Response Plots

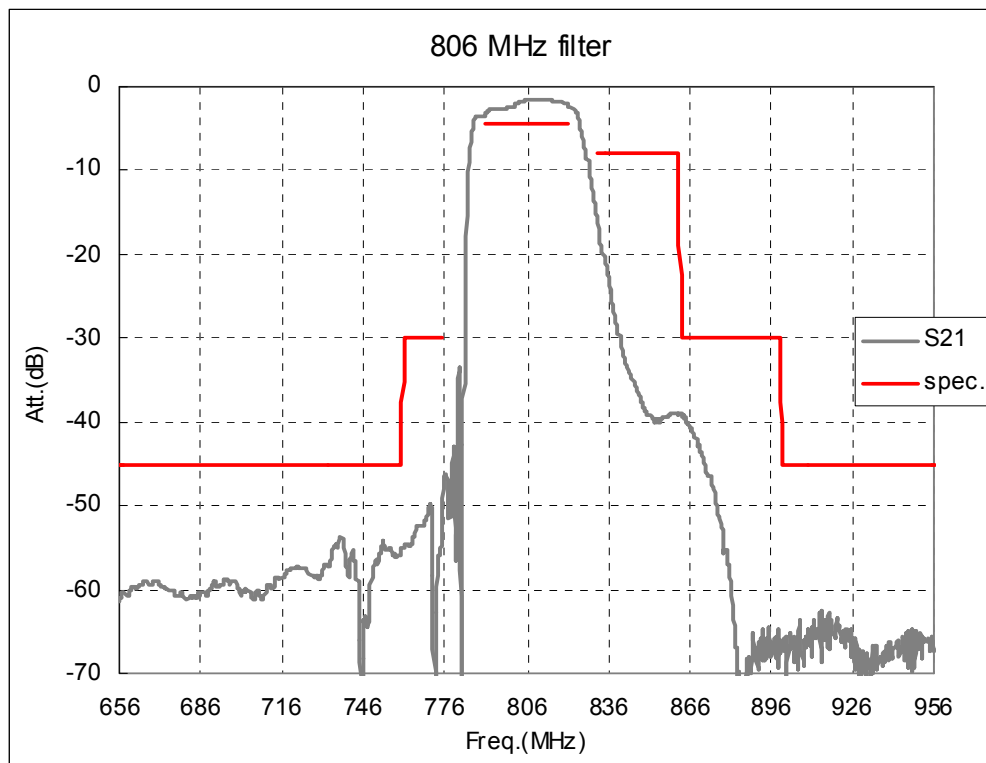
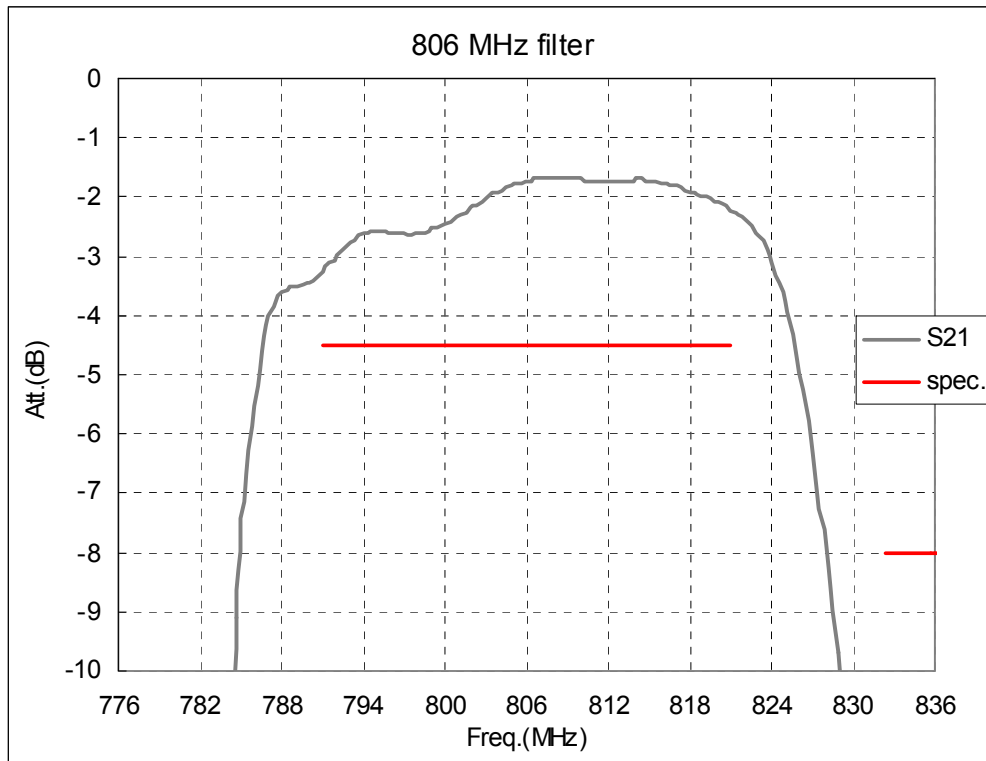

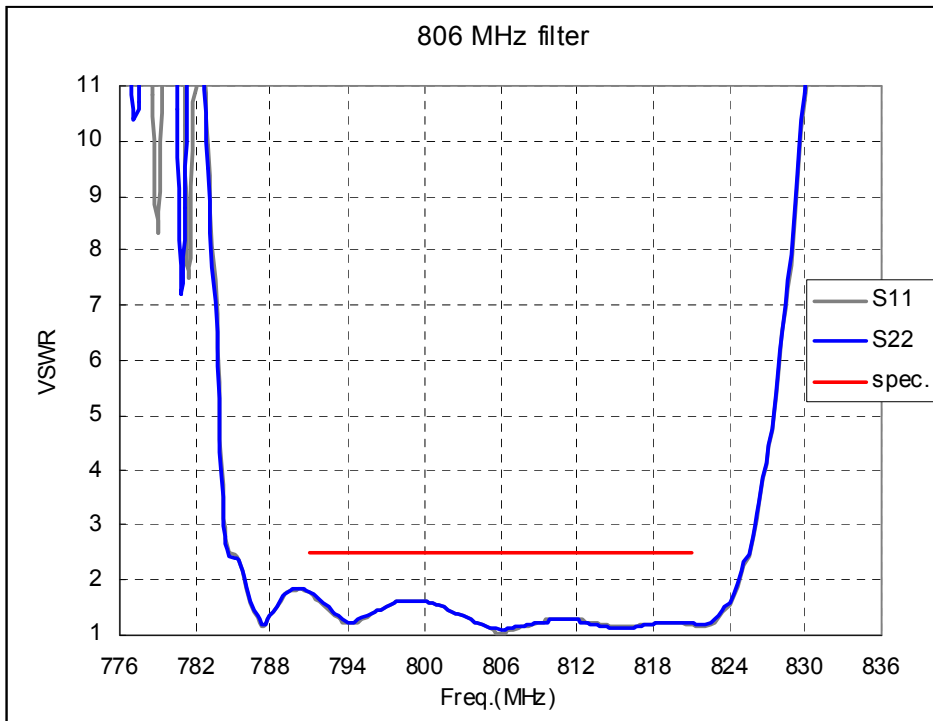
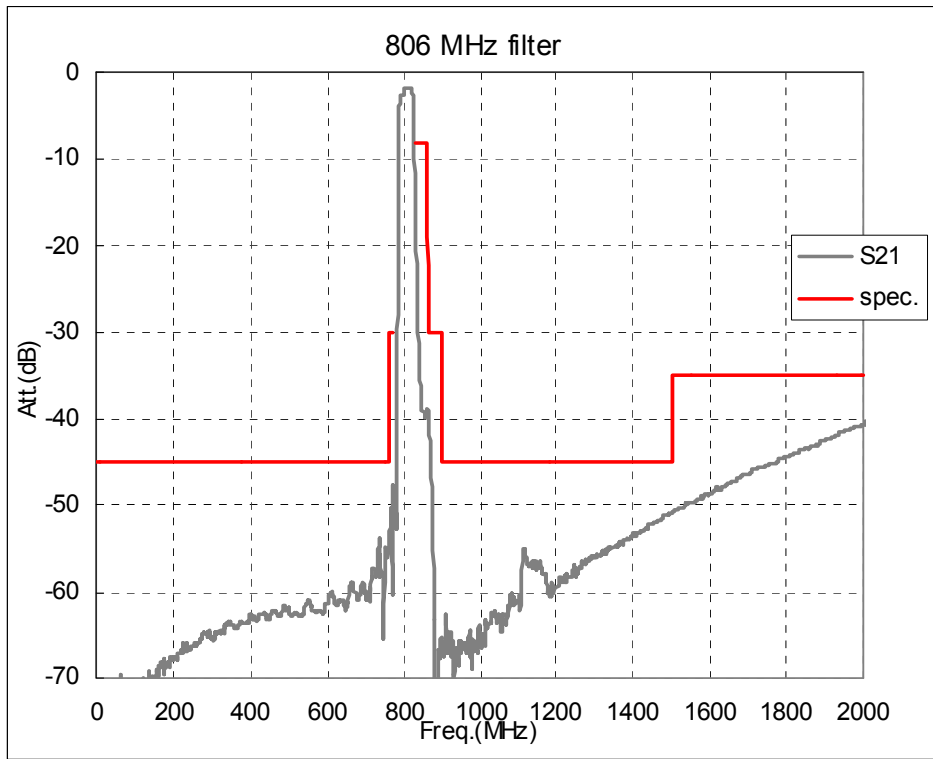

# SM3030-6 Case

## 6-Terminal Ceramic Surface-Mount Case 3.0 X 3.0 mm Nominal Footprint

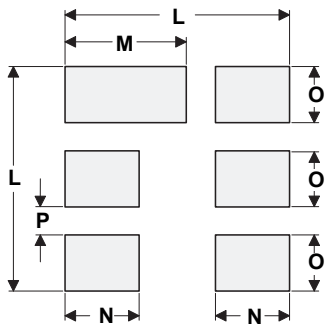

PCB Footprint Top View

### Case and PCB Footprint Dimensions

Dimension	mm			Inches		
	Min	Nom	Max	Min	Nom	Max
A	2.87	3.00	3.13	0.113	0.118	0.123
B	2.87	3.00	3.13	0.113	0.118	0.123
C	1.12	1.25	1.38	0.044	0.049	0.054
D	0.77	0.90	1.03	0.030	0.035	0.040
E	2.67	2.80	2.93	0.105	0.110	0.115
F	1.47	1.60	1.73	0.058	0.063	0.068
G	0.72	0.85	0.98	0.028	0.033	0.038
H	1.37	1.50	1.63	0.054	0.059	0.064
I	0.47	0.60	0.73	0.019	0.024	0.029
J	1.17	1.30	1.43	0.046	0.051	0.056
K	0.62	0.75	0.88	0.024	0.029	0.034
L		3.20			0.126	
M		1.70			0.067	
N		1.05			0.041	
O		0.81			0.032	
P		0.38			0.015	

### Case Materials

Materials	
Solder Pad Plating	0.3 to 1.0 $\mu\text{m}$ Gold over 1.27 to 8.89 $\mu\text{m}$ Nickel
Lid Plating	2.0 to 3.0 $\mu\text{m}$ Nickel
Body	$\text{Al}_2\text{O}_3$ Ceramic
	Pb Free

### TOP VIEW

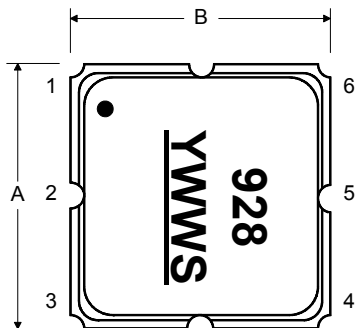

### BOTTOM VIEW

