

1. Features

- Low EMI noise and small footprint (11mm²) using inductor-imbedded ferrite substrate
- High efficiency using synchronous rectifier technology at 4MHz operation.
- Power-Save mode / Forced PWM automatic mode switching function
- 2% DC output voltage accuracy (PWM mode).
- 1A maximum load capability
- Wide input voltage range : 2.5 - 5.5V
- Fixed output voltage : 1.0V, 1.2V, 1.5V, 1.8V, 2.5V, 3.3V
- Internal soft start, over current protection, thermal shutdown protection



2. Description

The LXDC3EP series is a 1A output step-down DCDC converter, which is suitable for a space-limited or a noise-sensitive application. The device utilizes an inductor-embedded ferrite substrate, and the substrate eliminates radiated EMI noise and conduction noise efficiently.

By just putting this device, it can be used as a LDO replacement. Its low noise feature and easy to assembly feature assures reliable power supply quality.

The LXDC3EP series has a mode pin that allows the user to select Forced PWM mode or Power-Save mode that changes modes between pulse-skip operation and forced PWM operation automatically depending on the load.

In Power-Save mode, LXDC3EP series offers superior efficiency under light load condition, and it extends the battery life. When Forced PWM mode is selected, it works at fixed frequency (4MHz) over all load range. The advantages of this mode are easy filtering of switching frequency and better load transient response.

The integrated over current protection and the thermal shutdown protection features offer a reliable power supply operation.

3. Typical Application Circuit

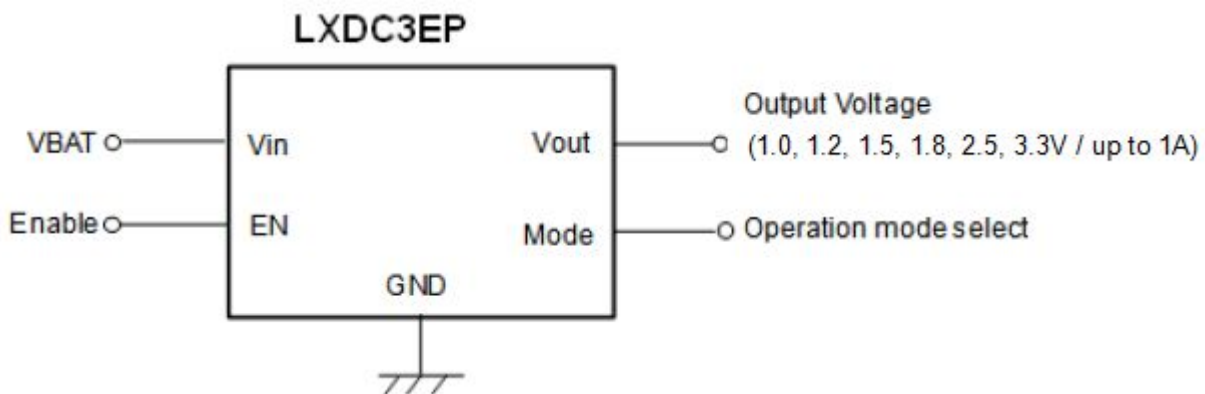

4. Mechanical details

4-1 Out line

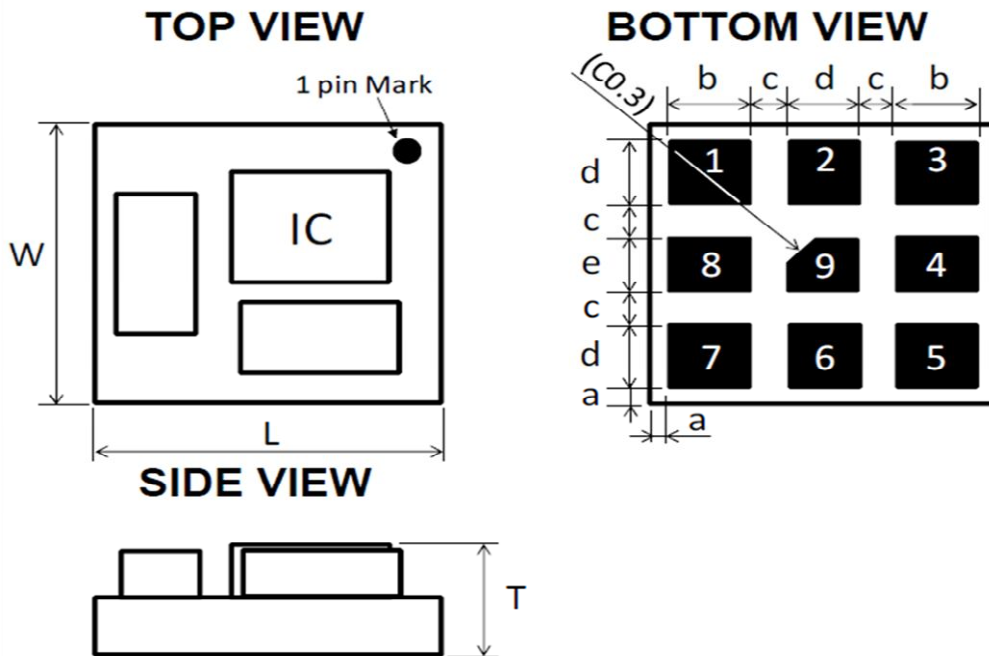

unit (mm)

Symbol	Dimension	Symbol	Dimension
L	3.5+/- 0.2	a	0.2+/- 0.2
W	3.2+/- 0.2	b	0.8+/- 0.1
T	1.3MAX	c	0.4+/- 0.1
		d	0.7+/- 0.1
		e	0.6+/- 0.1

4-2 Pin function

Pin	Symbol	I/O	Function
1	EN	Input	This is the ON/OFF control pin of the device. The device is in shutdown when the voltage to this pin is below 0.4V. Pulling this pin above 1.2V enables the device with soft start. This pin should not be left floating. EN=H: Device ON, EN=L: Device OFF
2,3,5,6,9	GND	—	Ground pin
4	Vout	Output	Regulated voltage output pin. Apply output load between this pin and GND.
7	MODE	Input	This is the operation mode select pin. This pin must not be left floating and must be terminated. Mode=H: Forced PWM mode Mode=L: Power-Save mode
8	Vin	Input	Vin pin supplies current to the LXDC3EP internal regulator.

4-3 Functional Block Diagram

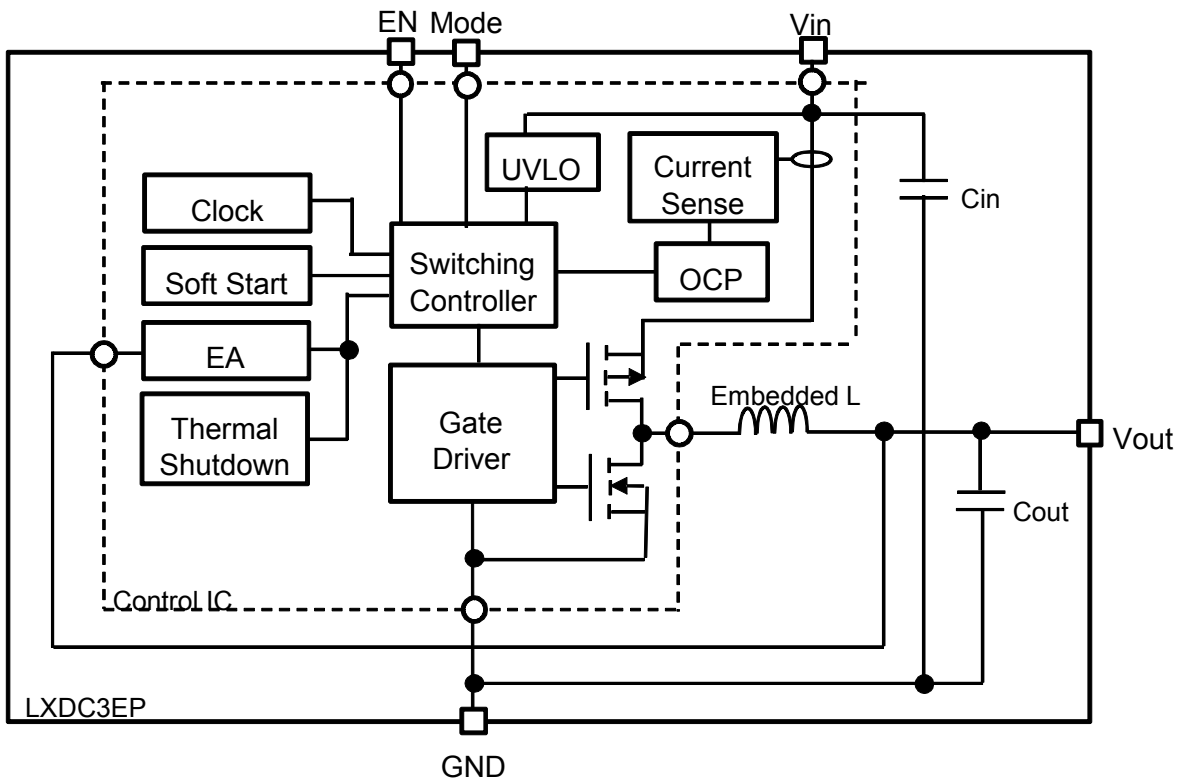

5. Ordering Information

Part number	Output Voltage	Device Specific Feature	MOQ
LXDC3EP10F-208	1.0V	Output current derating improvement type	T/R,1000pcs/R
LXDC3EP12F-151	1.2V	Output current derating improvement type	T/R,1000pcs/R
LXDC3EP15F-263	1.5V	Output current derating improvement type	T/R,1000pcs/R
LXDC3EP18F-264	1.8V	Output current derating improvement type	T/R,1000pcs/R
LXDC3EP25F-265	2.5V	Output current derating improvement type	T/R,1000pcs/R
LXDC3EP33F-204	3.3V	Output current derating improvement type	T/R,1000pcs/R

6. Electrical Specification**6-1 Absolute maximum ratings**

Parameter	symbol	rating	Unit
Maximum pin voltage	V _{in} , EN, MODE	6.0	V
Operating ambient temperature	T _a	-30 to +85	°C
Operating IC temperature	T _{IC}	-30 to +125	°C
Storage temperature	T _{STO}	-30 to +85	°C

6-2 Electrical Characteristics (Ta=25 °C)

Parameter	Symbol	Condition		Min.	Typ.	Max.	Unit
Input voltage	Vin	LXDC3EP10F-208		2.5	3.7	5.5	V
		LXDC3EP12F-151					
		LXDC3EP15F-263					
		LXDC3EP18F-264					
		LXDC3EP25F-265		3.0	3.7	5.5	
		LXDC3EP33F-204		4.0	5.0	5.5	
UVLO Voltage	UVLO				2.2		V
Output voltage accuracy	Vout	PWM Mode Vin-Vout>0.7V	LXDC3EP10F-208	0.976	1.0	1.024	V
			LXDC3EP12F-151	1.176	1.2	1.224	
			LXDC3EP15F-263	1.47	1.5	1.53	
			LXDC3EP18F-264	1.764	1.8	1.836	
			LXDC3EP25F-265	2.45	2.5	2.55	
			LXDC3EP33F-204	3.234	3.3	3.366	
Load current range	Iout			0	-	1000	mA
Ripple Voltage	Vrpl	Vin=3.7V Io=1000mA BW=100MHz	LXDC3EP10F-208	-	15	-	mV(p-p)
			LXDC3EP12F-151				
			LXDC3EP15F-263				
			LXDC3EP18F-264				
		Vin=3.7V Io=1000mA BW=100MHz	LXDC3EP25F-265	-	20	-	
		Vin=5.0V Io=1000mA BW=100MHz	LXDC3EP33F-204	-	20	-	
Efficiency	EFF	Vin=3.7V Io=300mA	LXDC3EP10F-208		86	-	%
			LXDC3EP12F-151		88		
			LXDC3EP15F-263		90	-	
			LXDC3EP18F-264		92	-	
			LXDC3EP25F-265		94	-	
		Vin=5.0V Io=300mA	LXDC3EP33F-204		94	-	
Enable Voltage	ENon	ON; Enable		1.2	-	-	V
	ENoff	OFF; Disable		-	-	0.4	
MODE Voltage	MODE-H	High; Forced PWM mode		1.2	-	-	V
	MODE-L	Low; Power-Save mode		-	-	0.4	

Parameter	Symbol	Condition	Min.	Typ.	Max.	Unit
SW Frequency	Freq		-	4	-	MHz
Over Current Protection	OCP		1000	1200	1700	mA
Start -up Time	Ton		-	170	-	usec

(*1)The above characteristics are tested using the application circuit on section 8

6-3 Thermal and Current De-rating Information

The following figure shows the power dissipation and temperature rise characteristics example. These data are measured on Murata's evaluation board of this device at no air-flow condition.

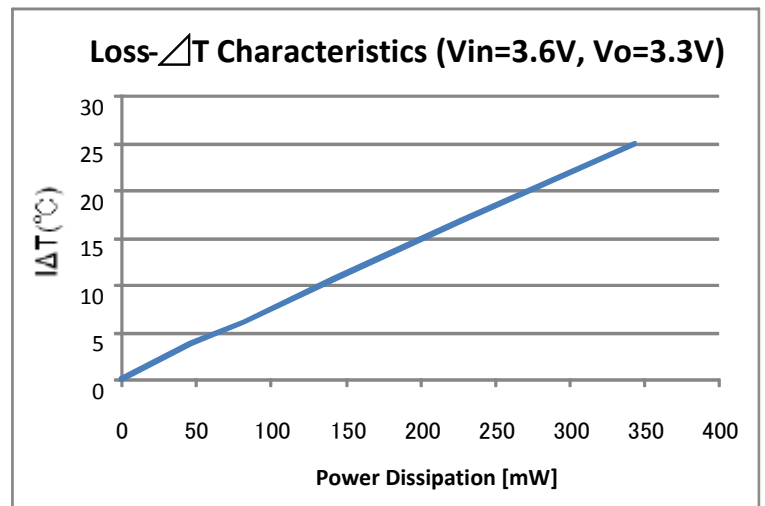
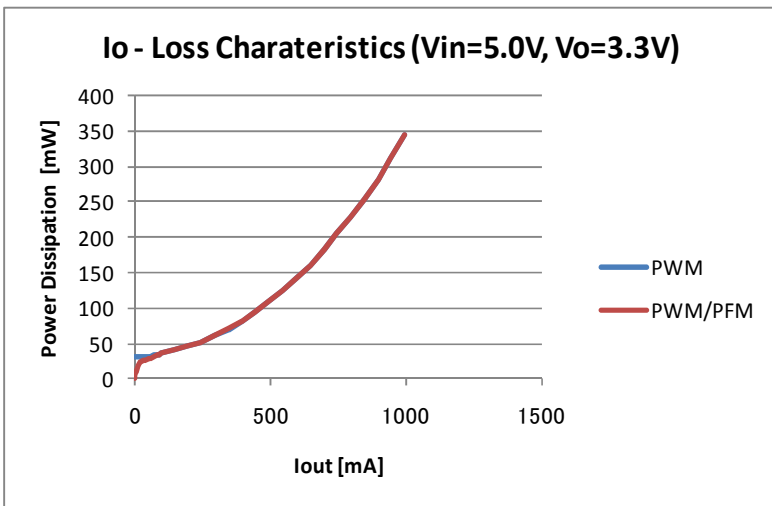

for the temperature of semiconductor is 80%.

MLCC capacitor's reliability and the lifetime is also dependant on temperature and applied voltage stress. Higher temperature and/or higher voltage cause shorter lifetime of MLCC, and the degradation can be described by the Arrhenius model. The most critical parameter of the degradation is IR (Insulation Resistance). The below figure shows MLCC's B1 life based on a failure rate reaching 1%. It should be noted that wear-out mechanisms in MLCC capacitor is not reversible but cumulative over time.

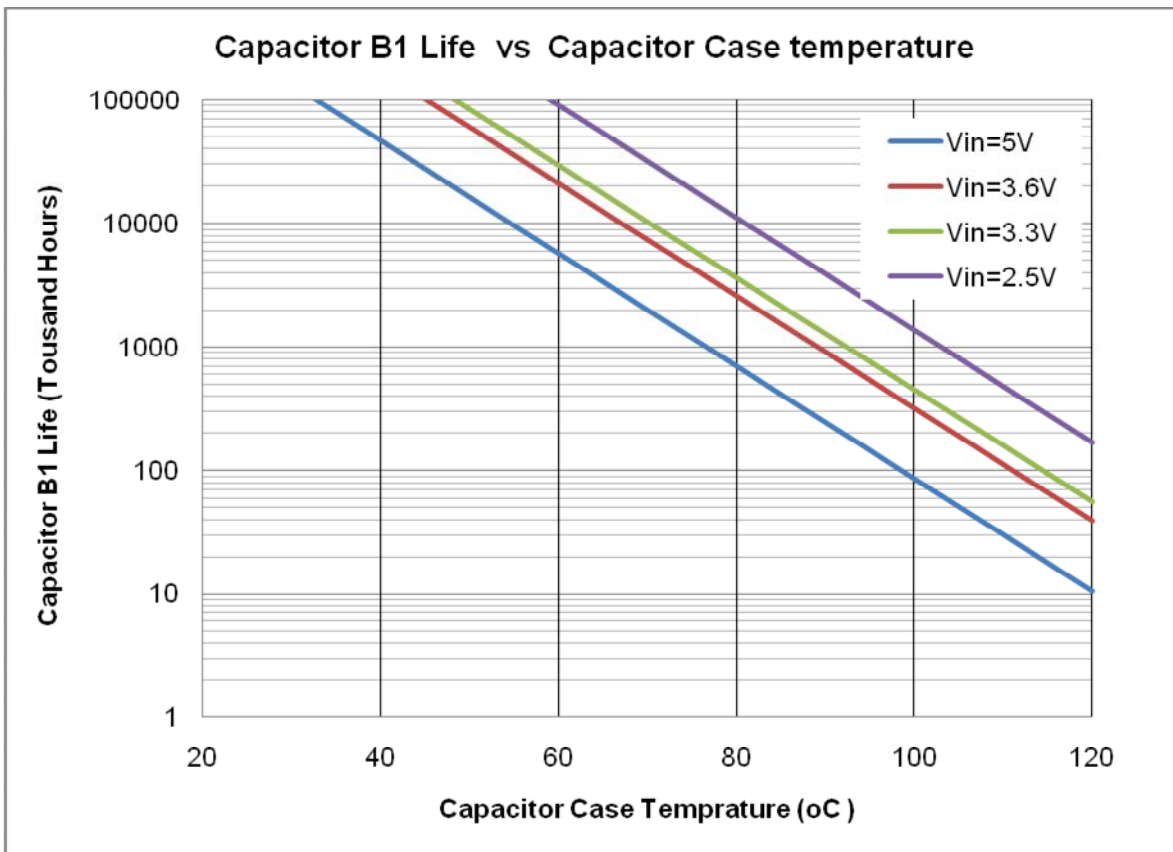

The following steps should be taken before the design fix of user's set for a reliable operation.

1. The ambient temperature of the device should be kept below 85 °C
2. The case temperature should be measured on the worst condition of each application. The temperature must be kept below 125 °C. An appropriate de-rating of temperature and/or output current should be taken.
3. The MLCC temperature should be considered as same as the case temperature. Considering the above figure, it should be checked if the expected B1 life of MLCC is acceptable or not.

7. Detailed Description

Power-Save Mode / Forced PWM Mode

The MODE pin allows selecting the operating mode. If the MODE pin is pulled to logic low voltage (MODE-L), the converter operates automatic pulse-skip and PWM mode. In this mode, the converter operates pulse-skip mode at light load current, and when the load current increases, the operating mode will change to PWM mode automatically. In this mode, the converter can work in high efficiency over wide load current range. The transition current between PFM and PWM is depend on V_{in} , V_{out} and other factors, but the ballpark threshold is about 50-200mA

If the MODE pin is pulled to logic high voltage (MODE-H), the device operates in Forced PWM mode. In this mode, the converter operates in PWM mode even at light load current. The advantage of this mode is that the converter operates with a fixed frequency that allows simple filtering of switching frequency. In this mode, the efficiency is lower compared to the PFM mode at light load current.

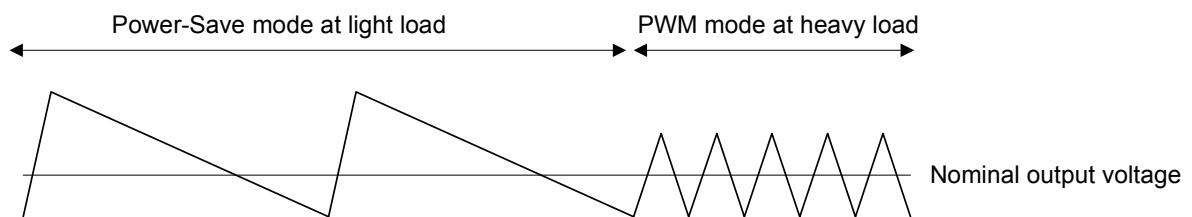

UVLO (Under Voltage Lock Out)

The input voltage (V_{in}) must reach or exceed the UVLO voltage (2.2Vtyp) before the device begins the start up sequence even when EN pin is kept high. UVLO function keeps away of an unstable operation at low V_{in} range

Soft Start

The device has an internal soft-start function that limits the inrush current during start-up. The soft-start system progressively increases the switching on-time from a minimum pulse-width to that of normal operation. Because of the function, the output voltage increases gradually from zero to nominal voltage at start-up event. The nominal soft-start time is 170usec.

Enable

The device starts operation when EN is set high and starts up with soft start. For proper operation, the EN pin must be terminated to logic high and must not be left floating. Pulling the EN pin to logic low forces the device shutdown.

Over Current Protection

When the output current reaches the OCP threshold, the device narrows the switching duty and decrease the output voltage. When the current goes below the threshold, the converter returns to normal operation automatically.

Thermal Shutdown

The device has a thermal overload protection function. When the internal IC's junction temperature exceeds around 150°C, the device goes into thermal shutdown. The device returns to its normal operation when the Internal IC's junction temperature falls below 130°C (typ). For reliable operation, the IC temperature should be kept below 125°C. Prolonged thermal overload condition may damage the device

8. Test Circuit

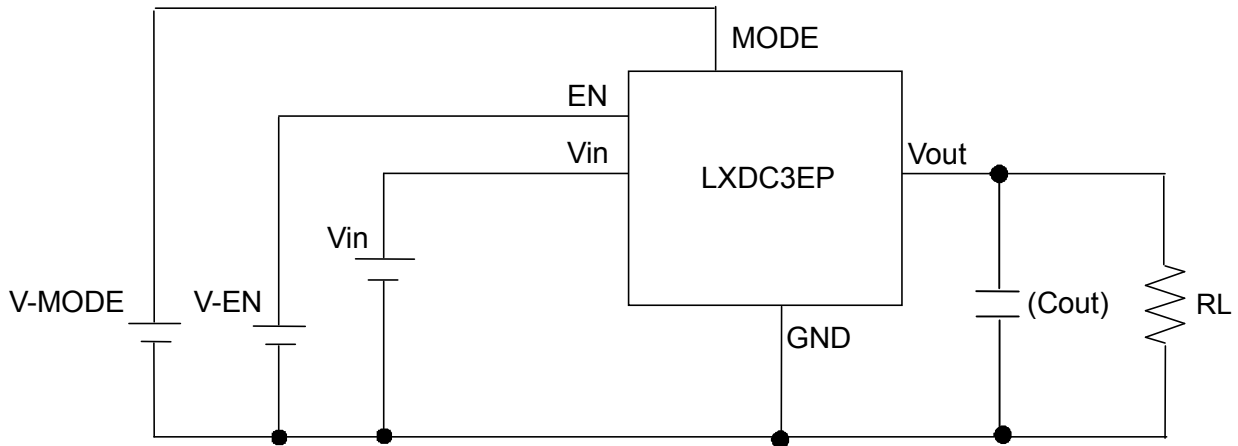

*Optional : Cout: 4.7uF/6.3V (LXDC3EP33F-204)

9. Reference Land Pattern

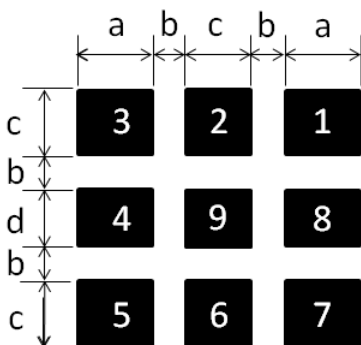

unit (mm)

Symbol	Dimension	Symbol	Dimension
a	0.8	c	0.7
b	0.4	d	0.6

10. Measurement Data

Micro DC-DC Converter evaluation board (P2LX0457B)

Measurement setup

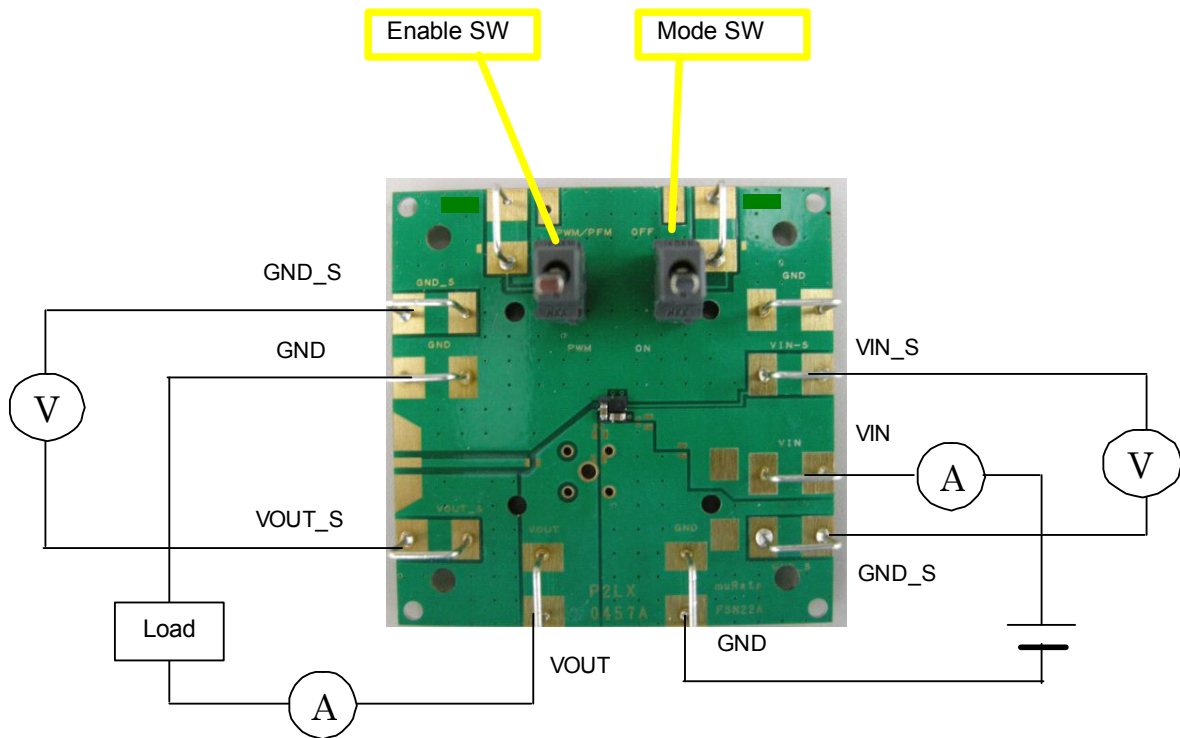

The enable switch has three positions.

1. When it is toggled to “ON” side, the device starts operation.
2. When it is toggled to “OFF” side, the device stop operation and keep shut down status.
3. When it is set to middle of “ON” and “OFF”, the EN pin becomes floated and can be applied an external voltage through the EN terminal pin on the EVB. If you don't apply external voltage to EN pin, the enable switch should not to be set to the middle position.

The mode switch has three states (PWM, PFM/PWM and Open).

1. When it is shorted to “PWM” side, the device operates PWM forced mode.
2. When it is shorted to “PFM/PWM” side, the device operates PFM/PWM automatic mode.
3. When it is set to open, the mode pin becomes floated and can be applied an external voltage through the Mode terminal pin on the EVB. If you don't apply external voltage to Mode pin, the mode switch should not to be set to the middle position.

Typical Measurement Data (reference purpose only) (Ta=25°C)

Efficiency

Vin=3.7V, Vout=1.0V

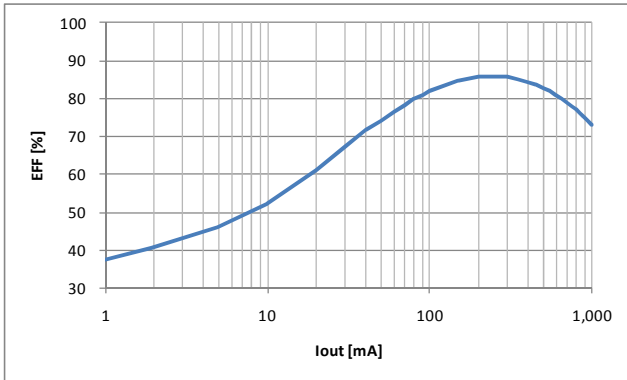

Vin=3.7V, Vout=1.2V

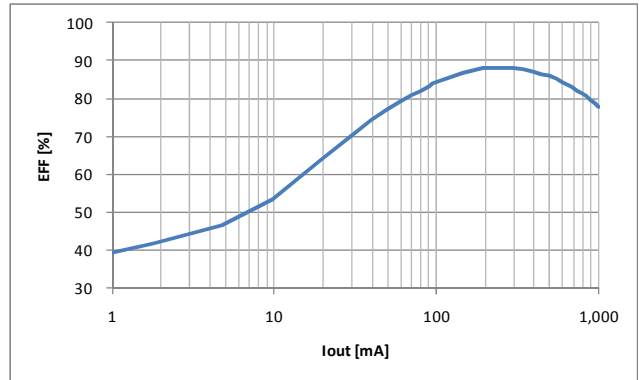

Vin=3.7V, Vout=1.5V

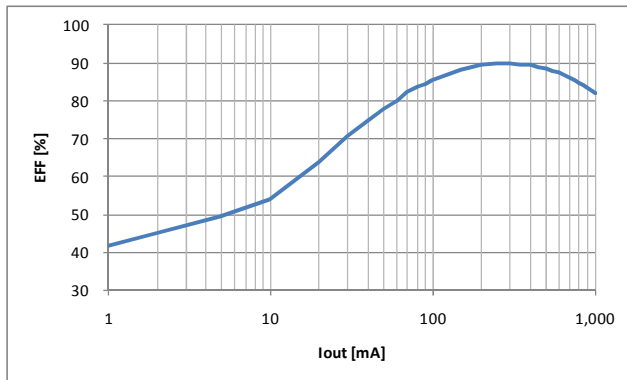

Vin=3.7V, Vout=1.8V

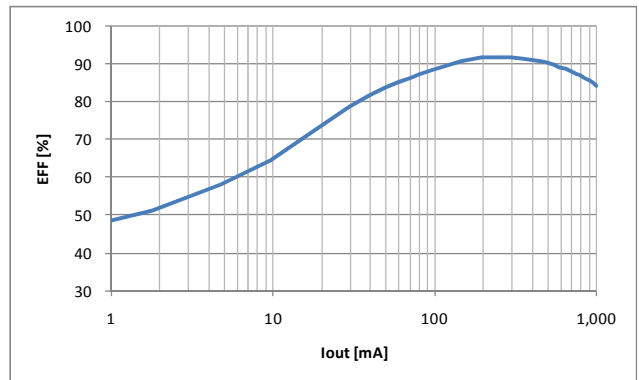

Vin=3.7V, Vout=2.5V

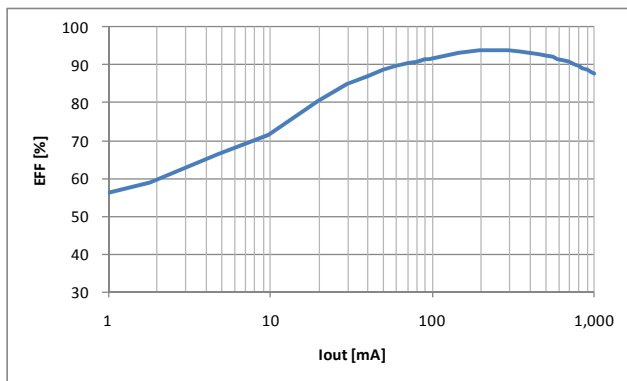

Vin=5.0V, Vout=3.3V

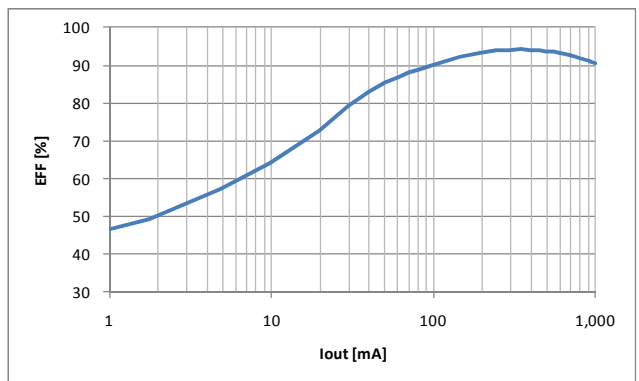

Road Regulation

Vin=3.7V, Vout=1.0V

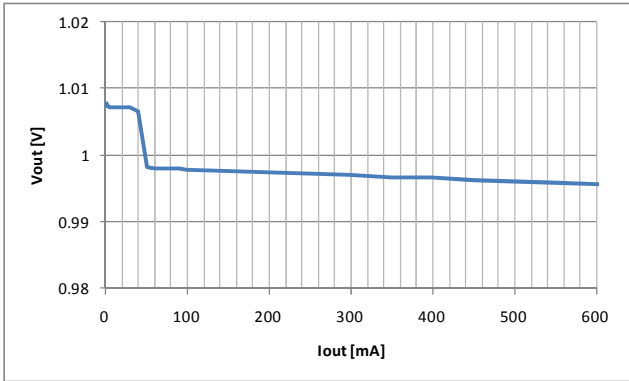

Vin=3.7V, Vout=1.2V

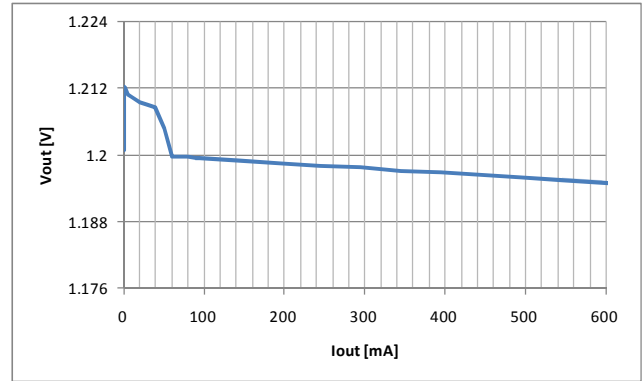

Vin=3.7V, Vout=1.5V

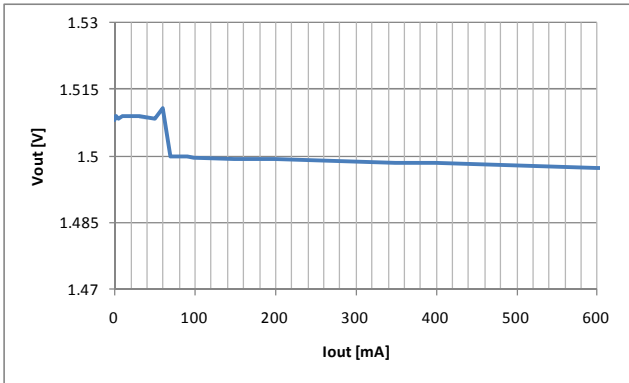

Vin=3.7V, Vout=1.8V

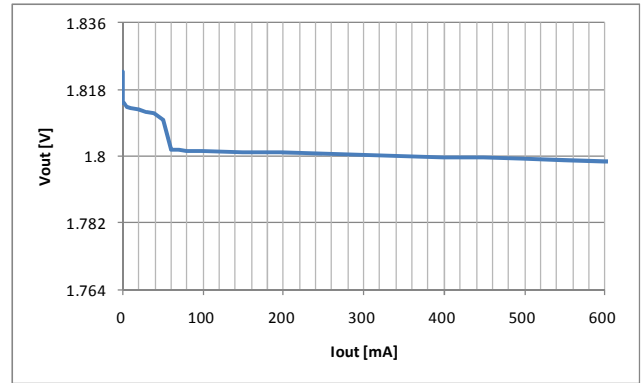

Vin=3.7V, Vout=2.5V

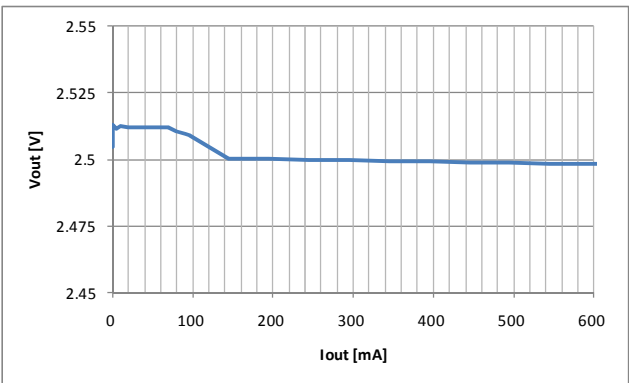

Vin=5.0V, Vout=3.3V

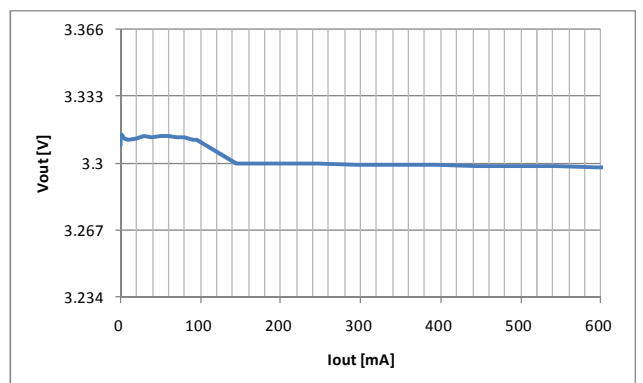

Output Ripple-Noise

Vin=3.7V, Vout=1.0V

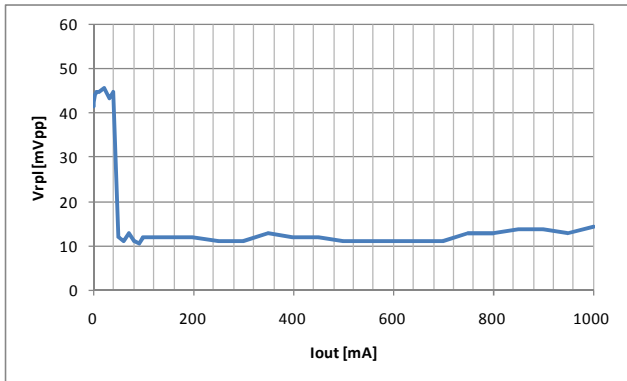

Vin=3.7V, Vout=1.2V

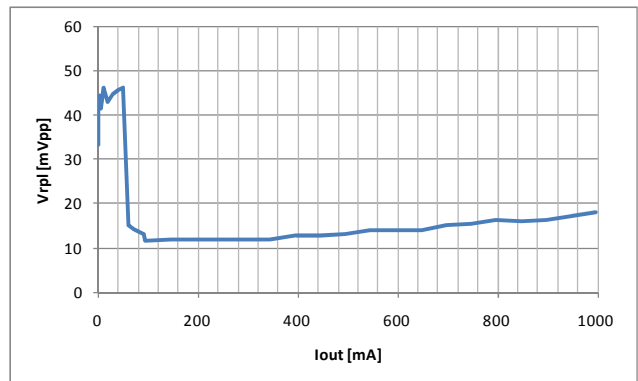

Vin=3.7V, Vout=1.5V

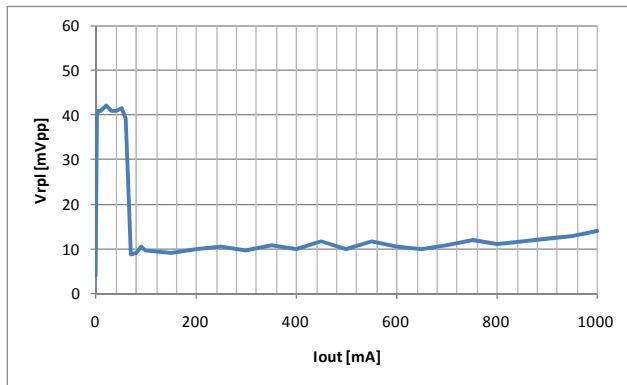

Vin=3.7V, Vout=1.8V

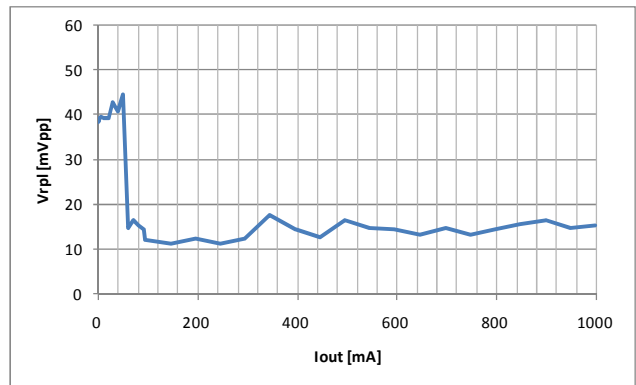

Vin=3.7V, Vout=2.5V

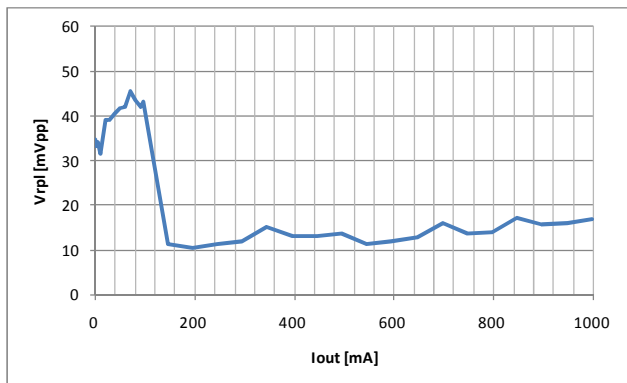

Vin=5.0V, Vout=3.3V



Typical Measurement Data (reference purpose only)

Load Transient Response

• $V_{in}=2.3V, V_{out}=1.2V$

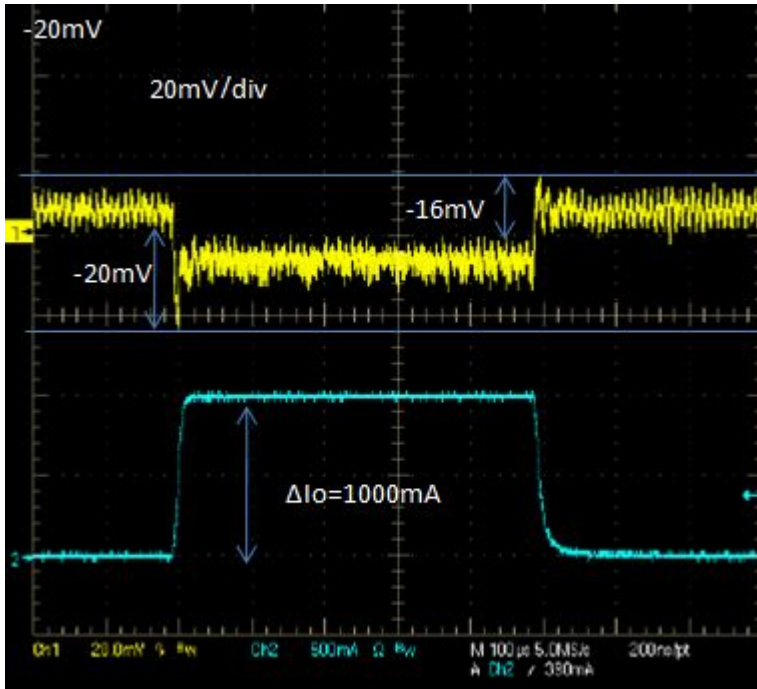

$V_{in}=3.7V, V_{out}=1.2V$

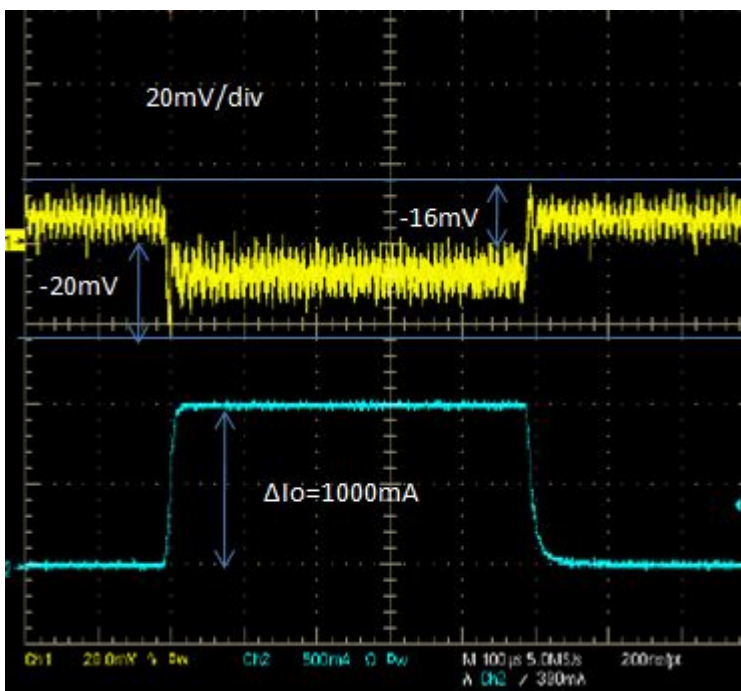

$V_{in}=5.5V, V_{out}=1.2V$

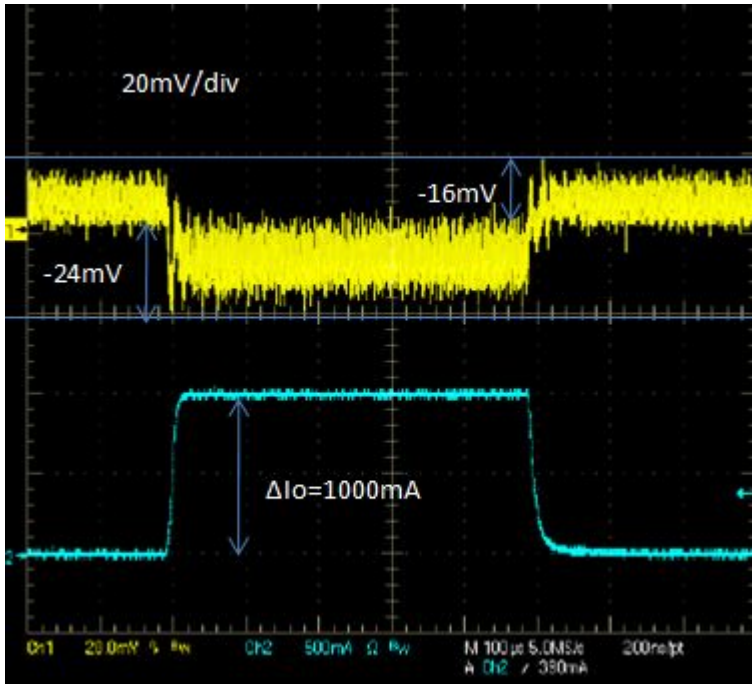

$V_{in}=5.0V, V_{out}=3.3V$

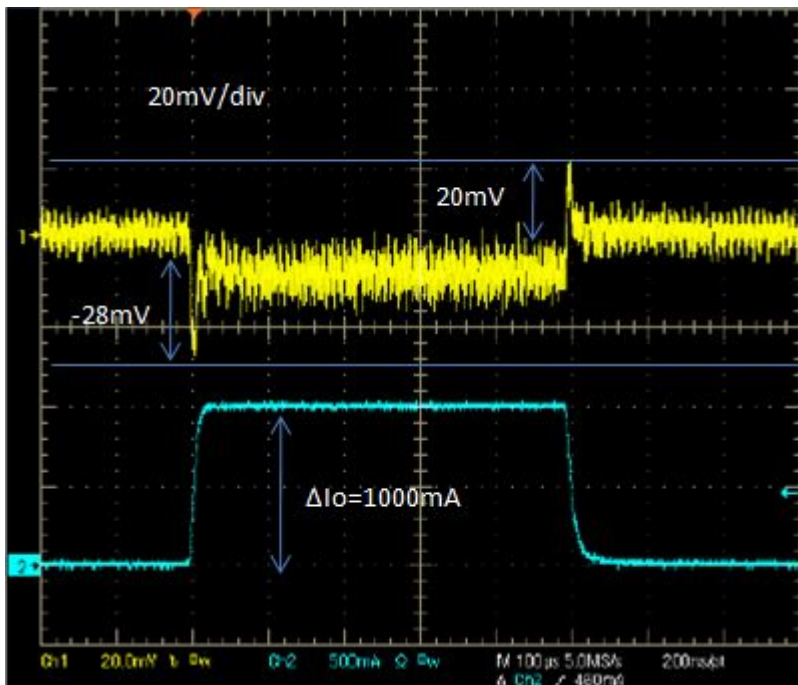

$V_{in}=5.5V, V_{out}=3.3V$

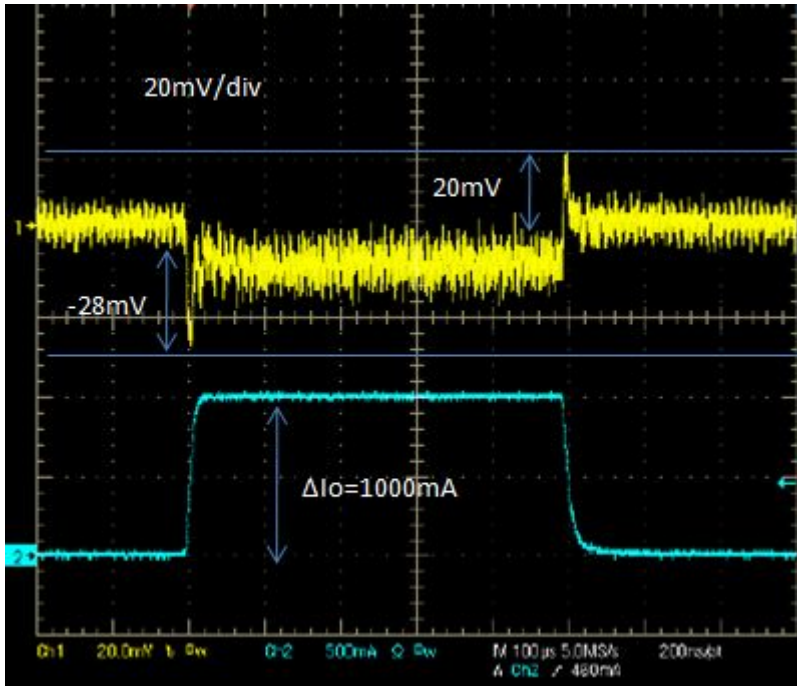

11. Reliability Tests

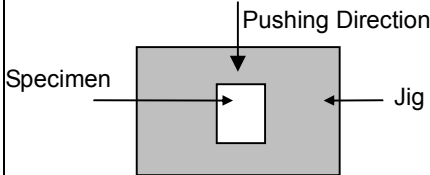
No.	Items	Specifications	Test Methods	QTY	Result (NG)	
1	Vibration Resistance	Appearance : No severe damages	Solder specimens on the testing jig (glass fluorine boards) shown in appended Fig.1 by a Pb free solder. The soldering shall be done either by iron or reflow and be conducted with care so that the soldering is uniform and free of defect such as by heat shock. Frequency : 10~2000 Hz Acceleration : 196 m/s ² Direction : X,Y,Z 3 axis Period : 2 h on each direction Total 6 h.	18	G (0)	
2	Deflection		Solder specimens on the testing jig (glass epoxy boards) shown in appended Fig.2 by a Pb free solder. The soldering shall be done either by iron or reflow and be conducted with care so that the soldering is uniform and free of defect such as by heat shock. Deflection : 1.6mm	18	G (0)	
3	Soldering strength (Push Strength)	9.8 N Minimum	Solder specimens onto test jig shown below. Apply pushing force at 0.5mm/s until electrode pads are peeled off or ceramics are broken. Pushing force is applied to longitudinal direction. 	18	G (0)	
4	Solderability of Termination	75% of the terminations is to be soldered evenly and continuously.	Immerse specimens first an ethanol solution of rosin, then in a Pb free solder solution for 3±0.5 sec. at 245±5 °C. Preheat : 150 °C, 60 sec. Solder Paste : Sn-3.0Ag-0.5Cu Flux : Solution of ethanol and rosin (25 % rosin in weight proportion)	18	G (0)	
5	Resistance to Soldering Heat (Reflow)	Appearance Electrical specifications	No severe damages Satisfy specifications listed in paragraph 6-2.	Preheat Temperature : 150-180 °C Preheat Period : 90+/-30 sec. High Temperature : 220 °C High Temp. Period : 20sec. Peak Temperature : 260+5/-0 °C Specimens are soldered twice with the above condition, and then kept in room condition for 24 h before measurements.	18	G (0)

No.	Items	Specifications	Test Methods	QTY	Result (NG)									
6	High Temp. Exposure	Appearance Electrical specifications No severe damages Satisfy specifications listed in paragraph 6-2.	Temperature: 85±2 °C Period: 1000+48/-0 h Room Condition: 2~24h	18	G (0)									
7	Temperature Cycle		Condition: 100 cycles in the following table <table border="1"> <thead> <tr> <th>Step</th> <th>Temp(°C)</th> <th>Time(min)</th> </tr> </thead> <tbody> <tr> <td>1</td> <td>Min. Operating Temp.+0/-3</td> <td>30±3</td> </tr> <tr> <td>2</td> <td>Max. Operating Temp.+3/-0</td> <td>30±3</td> </tr> </tbody> </table>	Step	Temp(°C)	Time(min)	1	Min. Operating Temp.+0/-3	30±3	2	Max. Operating Temp.+3/-0	30±3	18	G (0)
Step	Temp(°C)		Time(min)											
1	Min. Operating Temp.+0/-3		30±3											
2	Max. Operating Temp.+3/-0		30±3											
8	Humidity (Steady State)		Temperature: 85±2 °C Humidity: 80~90%RH Period: 1000+48/-0 h Room Condition: 2~24h	18	G (0)									
9	Low Temp. Exposure	Temperature: -40±2 °C Period: 1000+48/-0 h Room Condition: 2~24h	18	G (0)										
10	ESD(Machine Model)	C: 200pF, R: 0Ω TEST Voltage : +/-100V Number of electric discharges: 1	5	G (0)										
11	ESD(Human Body Model)	C: 100pF, R: 1500Ω TEST Voltage : +/-1000V Number of electric discharges: 1	5	G (0)										

12. Tape and Reel Packing

1) Dimensions of Tape (Plastic tape)

Unit: mm

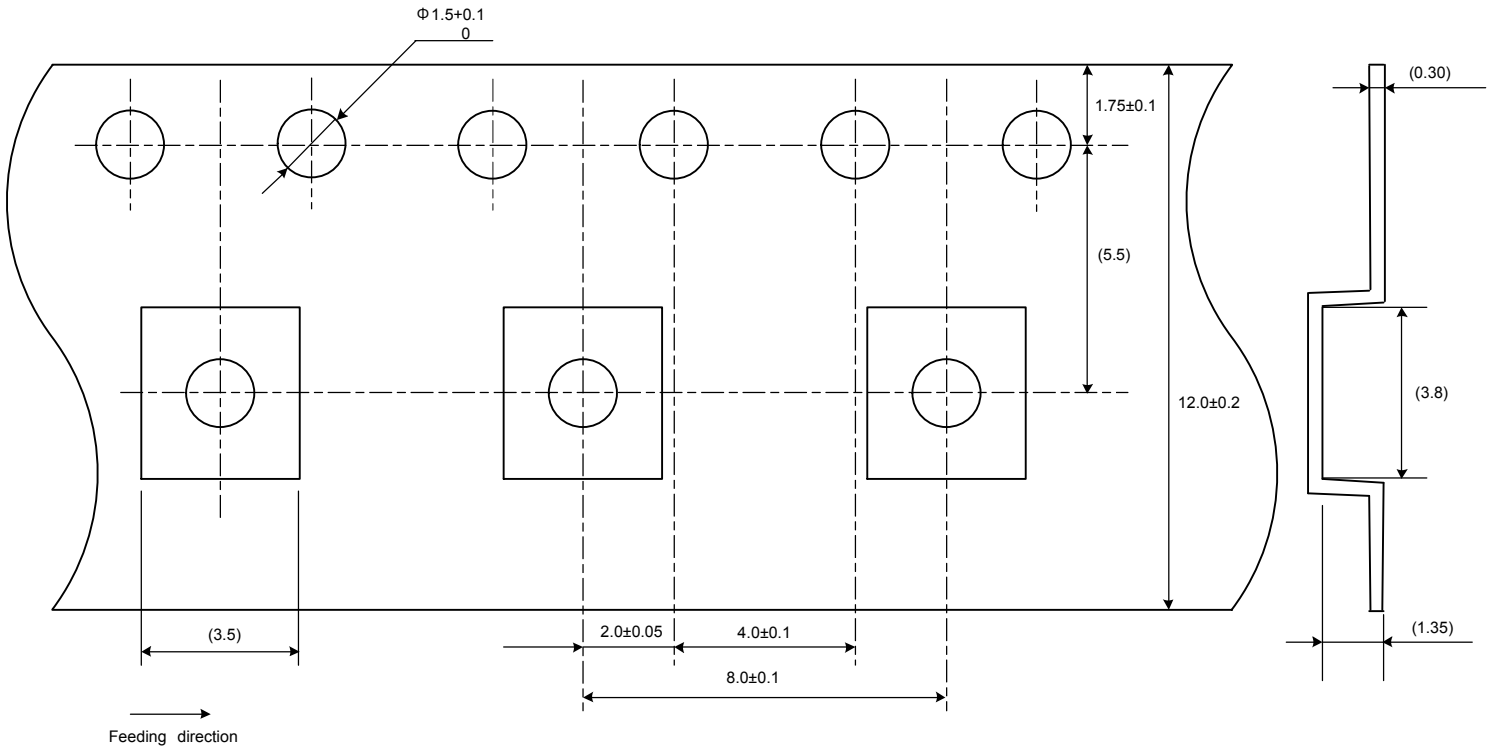

2) Dimensions of Reel

Unit: mm

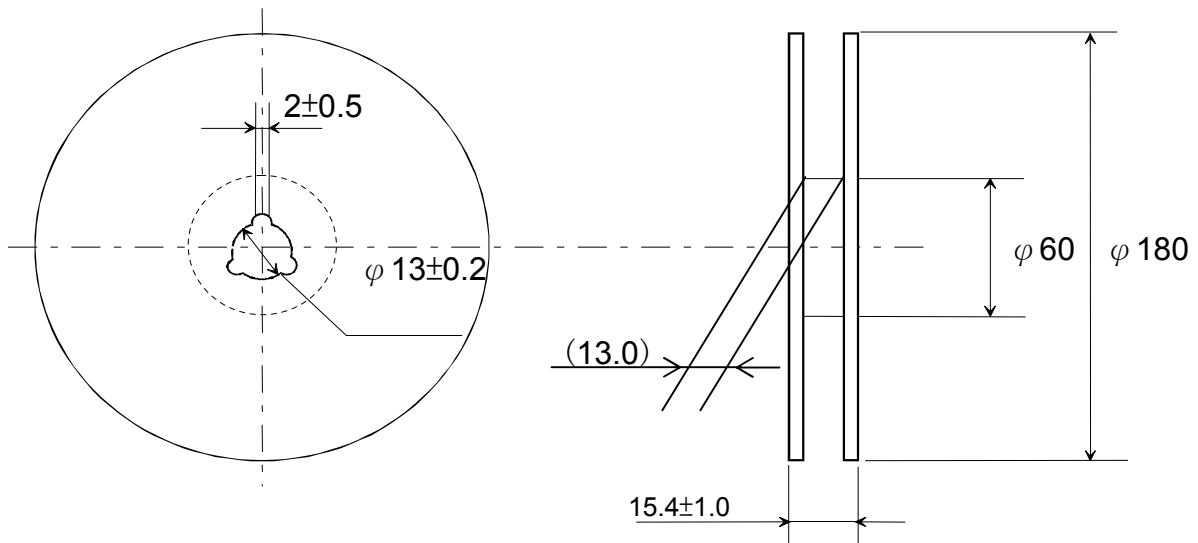

3) Taping Diagrams

- [1] Feeding Hole : As specified in (1)
- [2] Hole for chip : As specified in (1)
- [3] Cover tape : 50um in thickness
- [4] Base tape : As specified in (1)

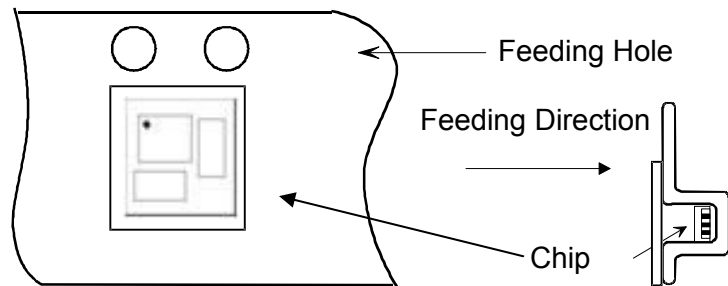
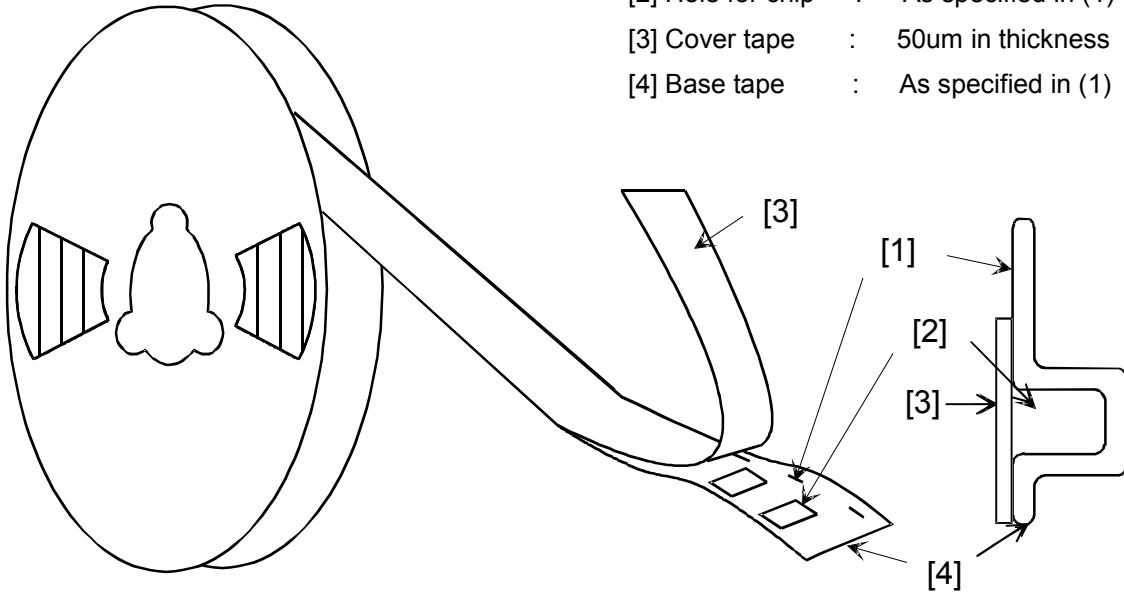

4) Leader and Tail tape

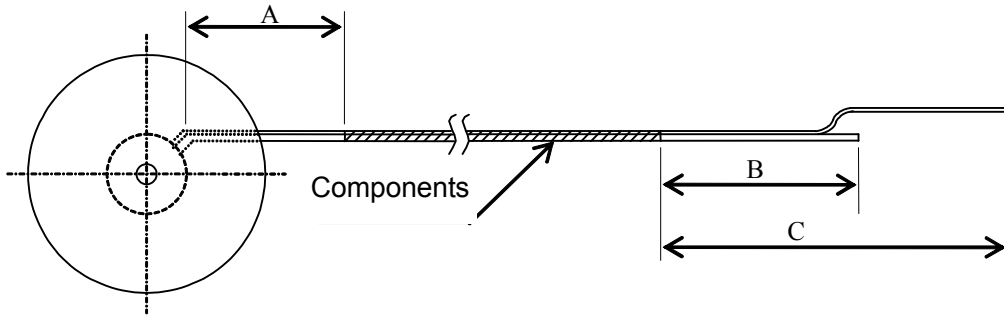

Symbol	Items	Ratings(mm)
A	No components at trailer	min 160
B	No components at leader	min 100
C	Whole leader	min 400

5) The tape for chips are wound clockwise, the feeding holes to the right side as the tape is pulled toward the user.

6) Packaging unit: 1,000 pcs./ reel

7) Material: Base Tape ... Plastic
 Reel ... Plastic
 Antistatic coating for both base tape and reel

8) Peeling of force

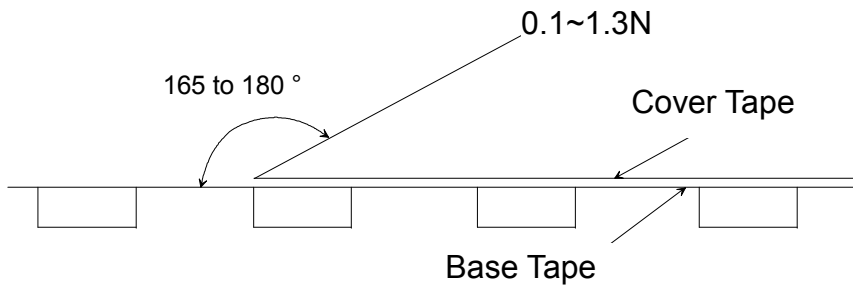

NOTICE

1. Storage Conditions:

To avoid damaging the solderability of the external electrodes, be sure to observe the following points.

- Store products where the ambient temperature is 15 to 35 °C and humidity 45 to 75% RH.
(Packing materials, In particular, may be deformed at the temperature over 40 °C.).
- Store products in non corrosive gas (Cl₂, NH₃, SO₂, No_x, etc.).
- Stored products should be used within 6 months of receipt. Solderability should be verified if this period is exceeded

This product is applicable to MSL1 (Based on IPC/JEDEC J-STD-020)

2. Handling Conditions:

Be careful in handling or transporting the product. Excessive stress or mechanical shock may damage the product because of the nature of ceramics structure.

Do not touch the product, especially the terminals, with bare hands. Doing so may result in poor solderability.

3. Standard PCB Design (Land Pattern and Dimensions):

All the ground terminals should be connected to ground patterns. Furthermore, the ground pattern should be provided between the IN and OUT terminals. Please refer to the specifications for the standard land dimensions.

The recommended land pattern and dimensions are shown for a reference purpose only. Electrical, mechanical and thermal characteristics of the product depend on the pattern design and material / thickness of the PCB. Therefore, be sure to check the product performance in the actual set. When using underfill materials, be sure to check the mechanical characteristics in the actual set.

4. Soldering Conditions:

Soldering is allowed up through 2 times.

Carefully perform preheating : ΔT less than 130 °C.

When products are immersed in solvent after mounting, pay special attention to maintain the temperature difference within 100 °C. Soldering must be carried out by the above mentioned conditions to prevent products from damage. Contact Murata before use if concerning other soldering conditions.

Reflow soldering standard conditions (example)

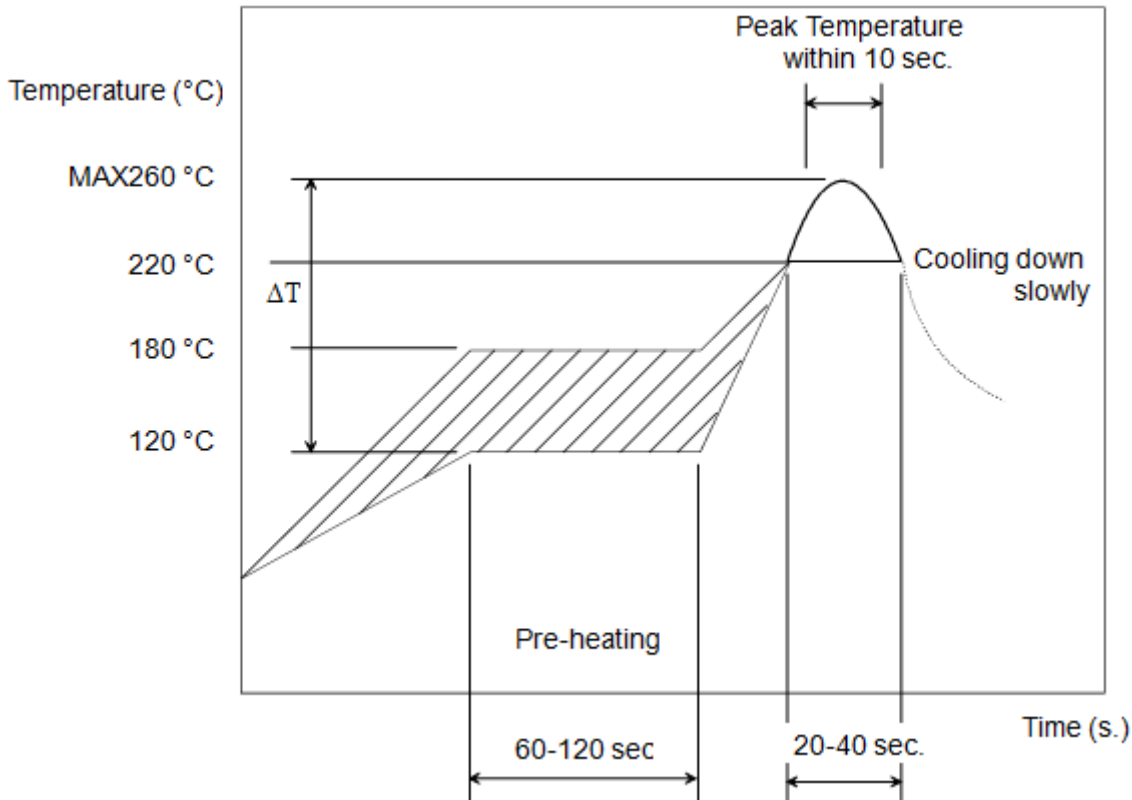

Use rosin type flux or weakly active flux with a chlorine content of 0.2 wt % or less.

5. Cleaning Conditions:

The product is not designed to be cleaned after soldering.

6. Operational Environment Conditions:

Products are designed to work for electronic products under normal environmental conditions (ambient temperature, humidity and pressure). Therefore, products have no problems to be used under the similar conditions to the above-mentioned. However, if products are used under the following circumstances, it may damage products and leakage of electricity and abnormal temperature may occur.

- In an atmosphere containing corrosive gas (Cl₂, NH₃, SO_x, NO_x etc.).
- In an atmosphere containing combustible and volatile gases.
- In a dusty environment.
- Direct sunlight
- Water splashing place.
- Humid place where water condenses.
- In a freezing environment.

If there are possibilities for products to be used under the preceding clause, consult with Murata before actual use.

If static electricity is added to this product, degradation and destruction may be produced.

Please use it after consideration enough so that neither static electricity nor excess voltage is added at the time of an assembly and measurement.

If product malfunctions may result in serious damage, including that to human life, sufficient fail-safe measures must be taken, including the following:

- (1) Installation of protection circuits or other protective device to improve system safety
- (2) Installation of redundant circuits in the case of single-circuit failure

7. Input Power Capacity:

Products shall be used in the input power capacity as specified in this specifications.

Inform Murata beforehand, in case that the components are used beyond such input power capacity range .

8. Limitation of Applications:

The products are designed and produced for application in ordinary electronic equipment (AV equipment, OA equipment, telecommunication, etc). If the products are to be used in devices requiring extremely high reliability following the application listed below, you should consult with the Murata staff in advance.

- Aircraft equipment.
- Aerospace equipment
- Undersea equipment.
- Power plant control equipment.
- Medical equipment.
- Transportation equipment (vehicles, trains, ships, etc.).
- Automobile equipment which includes the genuine brand of car manufacture, car factory-installed option and dealer-installed option.
- Traffic signal equipment.
- Disaster prevention / crime prevention equipment.
- Data-processing equipment.
- Application which malfunction or operational error may endanger human life and property of assets.
- Application which related to occurrence the serious damage
- Application of similar complexity and/ or reliability requirements to the applications listed in the above.



Note:

Please make sure that your product has been evaluated and confirmed against your specifications when our product is mounted to your product.

Product specifications are subject to change or our products in it may be discontinued without advance notice.

This catalog is for reference only and not an official product specification document, therefore, please review and approve our official product specification before ordering this product.