



- **Features**
 - ◆ Input voltage: 176-305Vac
 - ◆ Built-in active PFC function 0.98 Typ.
 - ◆ High efficiency: up to 90% Typ.
 - ◆ Built-in Lightning protection
 - ◆ Waterproof (IP67)
 - ◆ Constant Current / 0-10V Dimming / Clock Dimming(CLK)/PWM Dimming
 - ◆ Protection: OVP, SCP, OTP
 - ◆ Full Power at 65%Iomax~100%Iomax (Constant Power)



■ Specification

Model (ME075MxxxAQ_CP)		105	150	210	300	420
Input	Efficiency(220Vac)	90.0%	89.0%	88.0%	88.0%	87.0%
	Voltage Range (Vac)	176 ~ 305				
	Rated Input Voltage (Vac)	200-240				
	Frequency Range (Hz)	47~63				
	Power Factor	0.98 (Typical) , >0.9 at 220~277Vac input, with 70%~100% load conditions				
	THD	< 20%, at 220 ~ 277Vac input, with 70% ~ 100% load conditions				
	AC Current(Typ.)	0.42A MAX at 220VAC				
	Inrush Current(Typ.)	65A at 230Vac input 25°C cold start				
	Leakage Current(max.)	0.75mA at 277Vac 50Hz input				
Output	Rated Output Voltage (V)	108-72	75-50	54-36	38-25	27-18
	Output Voltage Range (V) _{Note.1}	108-43	75-30	54-22	38-15	27-11
	Rated Current(mA)	700-1050	1000-1500	1400-2100	2000-3000	2800-4200
	Output Current Range(mA)	70-1050	100-1500	140-2100	200-3000	280-4200
	Rated Power (W)	75(max)				
	Output Current Set Range	6.5%I _{o_max} ~100%I _{o_max}				
	Constant Power Output Set	65%I _{o_max} ~100%I _{o_max}				
	Ripple Current((PK-AV) /AV)	10% max. (peak-to-average value) at 100% Iout				
	Current Tolerance _{Note.2}	±5%				
	Line Regulation	±1%				
	Load Regulation	±3%				
	Setup, Rise Time	0.5s(typ.), measured at 220Vac input				
	Hold Up Time	10ms at 220Vac 100% load				
Dimming Control	12Vdc Output Voltage (Vdc)	10.8Vmin.~12Vtyp.~13.2Vmax.				
	12Vdc Output Current(Vdc)	0mA~20mA max.				
	0~10V/DIM+ Voltage	Absolute maximum voltage -10Vmin~20Vmax				
	0~10V/DIM+ Short Current	280uA~450uA (DIM+)=0				
	DIMMING FUNCTION	0~10V/10%I _o ~100%I _o ref. Dimming module diagram and dimming curve				
Protection	Over Voltage(V)	130	90	65	46	33
	Short Circuit	Hiccup mode.The power supply shall be self-recovery when the fault is removed.				
	Over Temperature	Protection type: the PSU will keep 50% normal output (Rated current) .				
Environment	Operating Temp.	-40~+70°C (Tc≤ 90°C)				
	Operating Humidity	20~95%RH, non-condensing				
	Storage Temp., Humidity	-40~+85°C, 5-100%RH				
	Temp. Coefficient	0.03%/°C (0~50°C)				
	Vibration	10~500Hz, 5G 12min/cycle, period for 72min each along X, Y, Z axes				
Safety & EMC	Safety Standard	UL8750, UL1012, CAN/CSA-C22.2No.107.1-01,EN61347-1, EN61347-2-13				
	Withstand Voltage	I/P-O/P:3.75KVAC I/P-CASE:3.75KVAC				
	Isolation Resistance	I/P-O/P ,I/P-FG,O/P-FG:100M Ohms/500VDC/25°C/70%RH				
	EMC Emission	EN55015, EN61000-3-2 Class C, EN61000-3-3				
Others	EMC Immunity	EN61000-4-2,3,4,5,6,8,11. EN61547 (Surge L-N 10KV)				
	MTBF	250,000 hours, measured at full load, 25°C ambient temperature MIL-HDBK-217F(25°C)				
	Dimension	173x67.5 x 37mm (LxWxH)				
	Weight	0.8kg				

Note.1: refer to V/I curve

Note.2: At Rated Current ,Includes set up tolerance, line regulation and load regulation.

■ Curve

Derating Curve

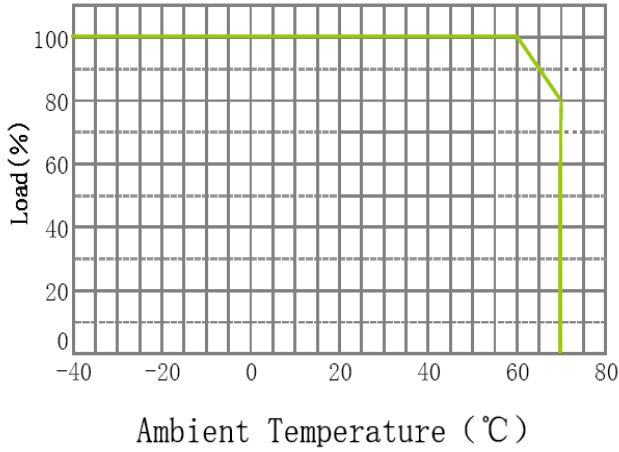

V/I Curve

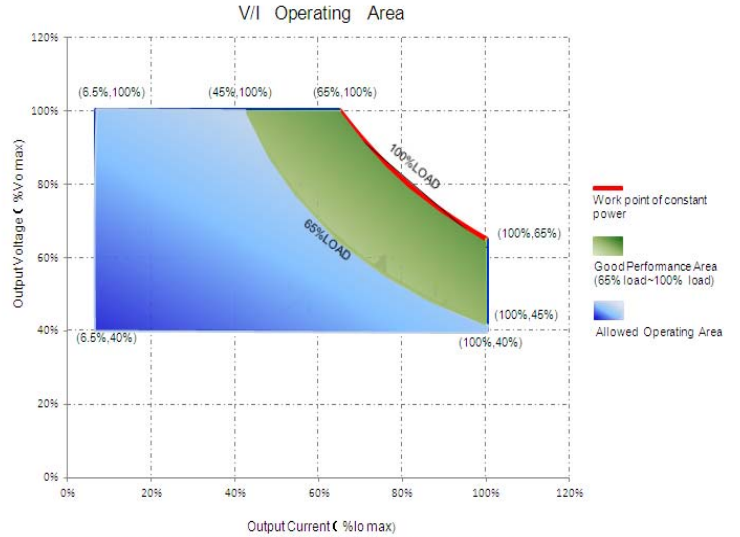

Note: Output current setting range with constant power 65%Io max-100%Io max.

Derating Curve

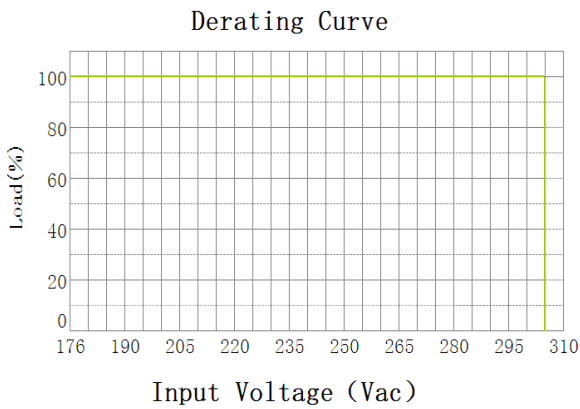

Lifetime VS. Tcase

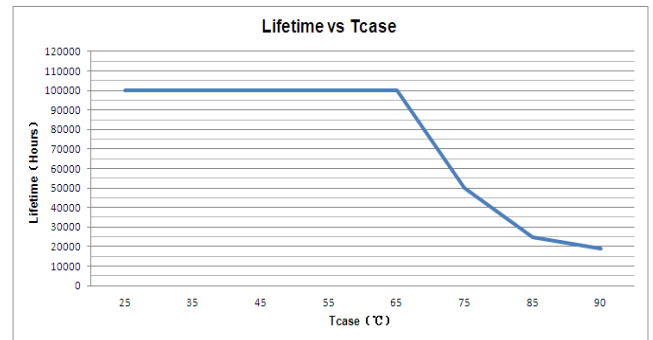

■ **Instruction**

1.Field Programmable Topology

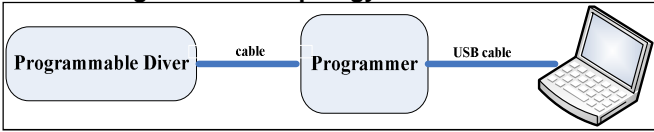

The programmable driver can be programmed by using special PC software and the programmer module.

2.Dimming Interface Description

Pin description

Pin	Name	Value	Description
1	Vaux 12V	10.8V-13.2V	Passive dimmers power supply
2	Dim+/Program	0-10V	Dimming/Programming input
3	Dim-	0V	DC Ground

3.Dimming Software Function Instruction

■ **Adjustable Output Current(AOC)**

Adjustable Output Current (AOC)
Module Current %

Users can set the rated current between 10%~100% by 1% per step.

■ **Adjustable Startup Time(AST)**

Adjustable Startup Time (AST)
Start Fadeup Time s

At power ON, the fast fade-up of light can be unpleasant in certain applications. To avoid such a situation, the driver fade-up time at start-up can be programmed to a value among 0s, 1s, 2s, 5s, 10s, 20s, 40s. The default start fade

■ **Set Module Working Hrs**

Set Module Working hrs (SMW)
Set Module Working hrs hrs

Use to reset the working hour counting in the microcontroller of the driver and collaborate with CLO.

■ **1-10V**

Allow users to set the max and min output current and corresponding output voltage to clarify the 1-10V dimming curve. Input a 0~10V signal from 2nd pin of the dimming interface. Default: input $\leq 1V$, output current 10%; input $\geq 8.5V$, output current 100%.

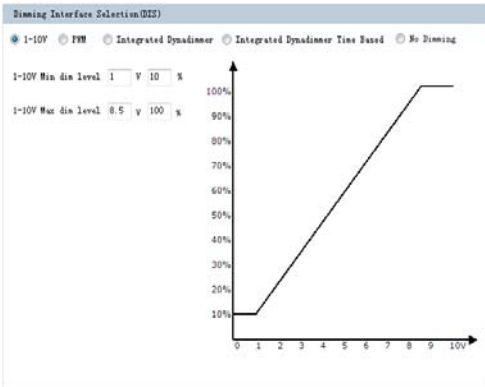

■ **PWM**

Input a PWM signal from the 2nd pin(Dim+/Program) of the dimming interface to change the output current. PWM duty circle: 1%~99%(it has both positive and negative logics), frequency: 500Hz~5kHz, 3V~10V is high, 0.3V~0.8V is low.

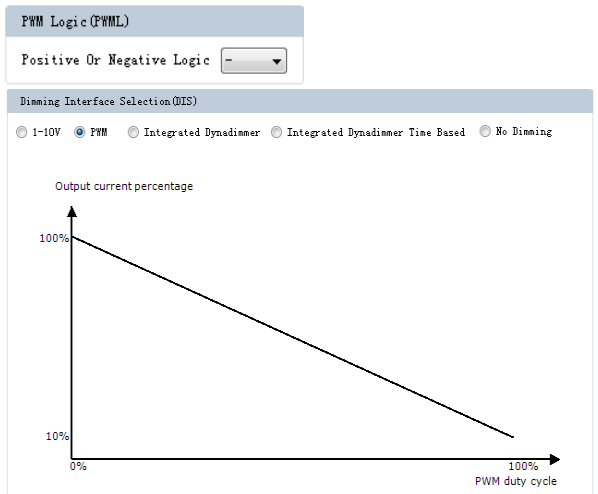
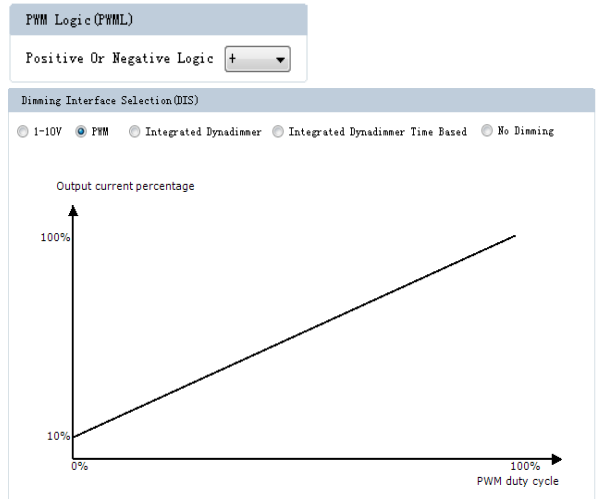

■ Instruction

■ Integrated Dynadimmer

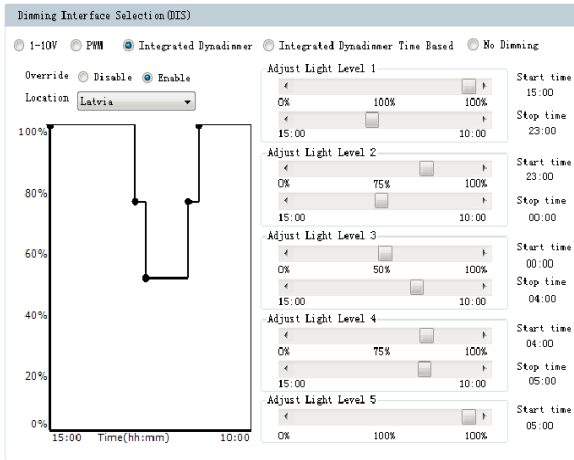

Integrated Dynadimmer allows dimming to predefined light levels based on the nightly operating time. With flexibility in setting time and light levels, the user can configure the driver for specific locations and application needs. Using Integrated Dynadimmer, it is possible to set up to 5 dim levels and time intervals. The driver does not have a real time clock. Instead it runs a virtual clock, determined by the length of nightly operating hours. After 3 ON-OFF cycles, the driver will calculate the virtual clock time. A valid ON-time is defined as a period during which the driver operates continuously for ≥ 4 hours to ≤ 24 hours. For example, if the requirement in summer is: 23:00-00:00: 75%, 00:00-04:00: 50%, 04:00-05:00: 75% (other time 100% or Off). The driver should be powered on for 7h, so it can calculate the virtual clock time as 22:00. Then we can set the dimming plan: 22:00~23:00: 100%, 23:00-00:00: 75%, 00:00-04:00: 50%, 04:00-05:00: 75%. From summer to winter, the valid ON-time changes day by day. The driver should be powered on for 17h in winter, and it also can calculate the virtual clock time as 17:00. Then the dimming plan is 17:00~23:00: 100%, 23:00-00:00: 75%, 00:00-04:00: 50%, 04:00-05:00: 75%, 05:00~10:00: 100%. From the above, if we set the dimming plan as shown in the picture, after repeating the driver ON-time for 3 consecutive days, the dimming plan takes effect from the 4th day onwards. Each day the driver powered on, it has a different start time according to the virtual clock time. So the driver can satisfy different requirements for different seasons.

■ Constant Light Output(CLO)

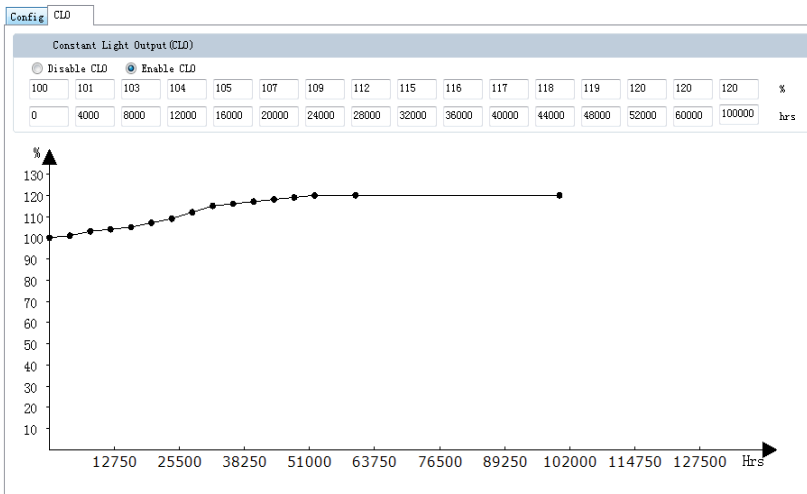

■ Integrated Dynadimmer Time Based

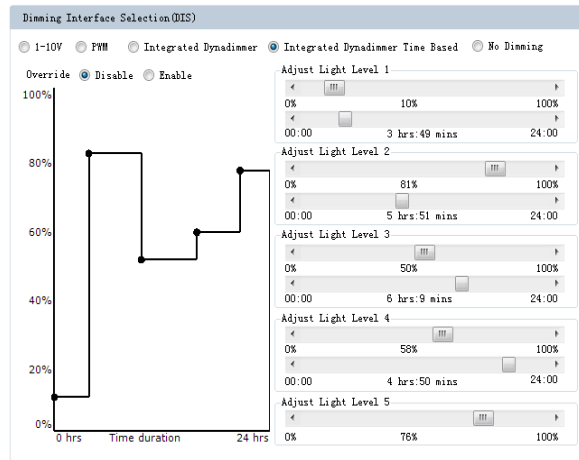

Allow users to separate 24hrs into 5 sections and corresponding output current.

■ No Dimming

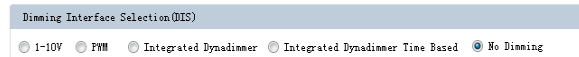

The driver will be in constant output mode.

Traditional light sources suffer from depreciation in light output over time. This applies to LED light sources as well. The CLO feature enables LED solutions to deliver constant lumen output through the life of the light engine. Based on the type of LEDs used, heat sinking and driver current, it is possible to estimate the depreciation of light output for specific LEDs and this information can be entered into the driver. The driver counts the number of light source working hours and will increase output current based on this input to enable CLO. When the CLO feature is enabled, the driver nominal output current will be defined by the CLO percentage as shown by the equation below: $\text{Driver target nominal output current} = \text{CLO percentage} * \text{AOC}$. For example, in the CLO profile shown in Figure, between 52,000-60,000 working hours, the CLO percentage is set at 120%. Assuming the nominal AOC is set to 500mA, the driver output current with CLO enabled will be $1.20 * 500 = 600 \text{ mA}$. The CLO percentage can be set to a value between 100%-120%, in increments of 1%. The LED module working hours can be set at any value between (0-100,000 hours).

■ Mechanical Specification

Dimensions(Unit:mm)

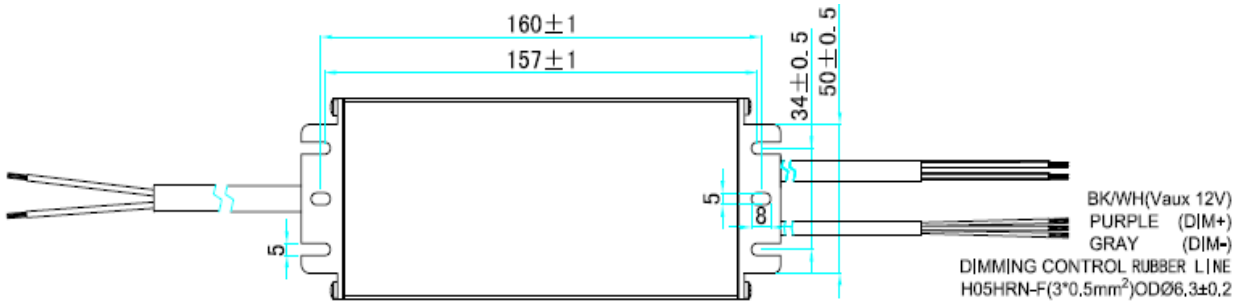

RUBBER LINE CCC 60245 IEC 57 (YZW)/VDE H05RN-F
 AC INPUT (2*1.0mm²) ODØ 6.8±0.3mm
 BROWN/L BLUE/N

RUBBER LINE VDE H05RN-F
 DC OUTPUT (2*1.0mm²) ODØ 6.8±0.3mm
 RED/V+ BLACK/V-

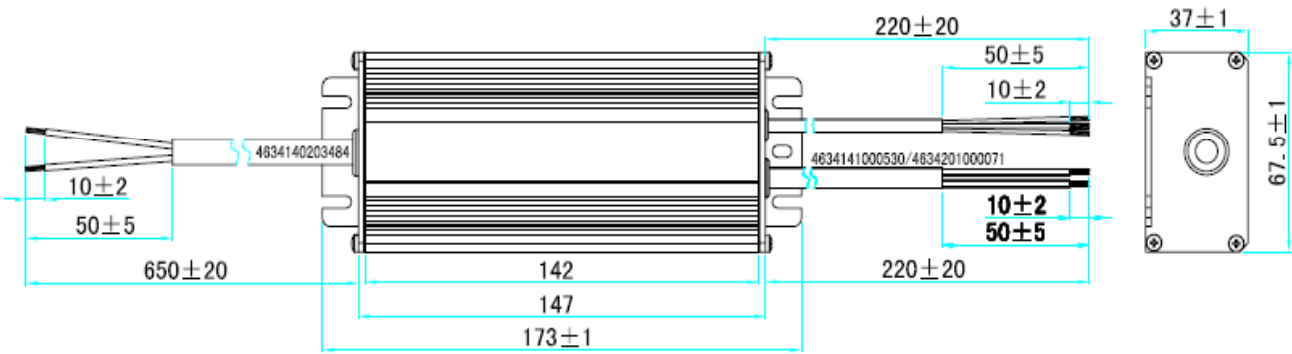
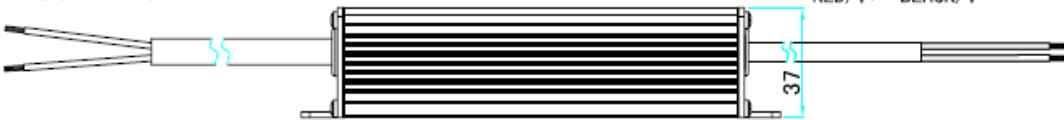

RoHS Compliance:

Our products comply with the European Directive 2002/95/EC, calling for the elimination of lead and other hazardous substances from electronic products.