

DESCRIPTION

The MP62040/MP62041 Power Distribution Switch is designed for high-side load switch. The switch operates from 1.7V to 5.5V nominal input voltage and includes an 85mΩ power MOSFET to handle up to 2A continuous load.

The MP62040/MP62041 has slew rate control with 115μs rising time to limit inrush current when enabling the switch.

The built-in level shift function allows a logic signal on enable input that may be different from the supply voltage to switch the high side P-channel MOSFET ON or OFF.

The MP62040/MP62041 is available in an ultra-small UTQFN4 package, with ultra-low height (0.55mm typ).

FEATURES

- 2A Continuous Current
- 1.7V to 5.5V Supply Range
- Soft Start: 115μs
- 1μA Shutdown Current
- 85mΩ MOSFET
- Active High & Active Low Options
- Space saving 1.6x1.2 mm UTQFN4 Package (0.55mm Height)

APPLICATIONS

- Load switch in portable applications
- Battery switch-over circuits
- Level translator

For MPS green status, please visit MPS website under Quality Assurance. "MPS" and "The Future of Analog IC Technology" are Registered Trademarks of Monolithic Power Systems, Inc.

TYPICAL APPLICATION

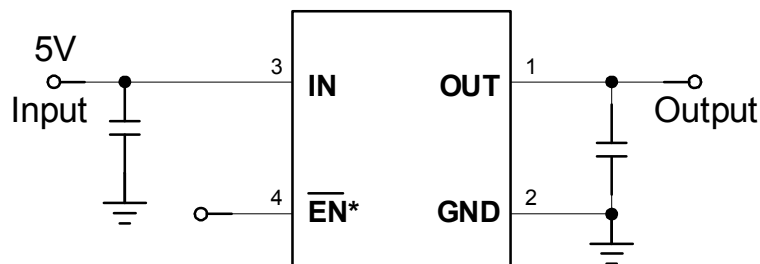

MP62040 / MP62041

(*: EN is active high for MP62041)

Single-Channel

PACKAGE REFERENCE

Part Number	Enable	Switch	Maximum Continuous Load Current	Package	Top Marking	Free Air Temperature (T _A)
MP62040DQFU*	Active Low	Single	2A	UTQFN4	AGY	-40°C to +85°C
MP62041DQFU**	Active High			UTQFN4	AEY	

* For Tape & Reel, add suffix -Z (e.g. MP62040DQFU-Z).

For RoHS compliant packaging, add suffix -LF (e.g. MP62040DQFU-LF-Z)

** For Tape & Reel, add suffix -Z (e.g. MP62041DQFU-Z).

For RoHS compliant packaging, add suffix -LF (e.g. MP62041DQFU-LF-Z)

PACKAGE REFERENCE

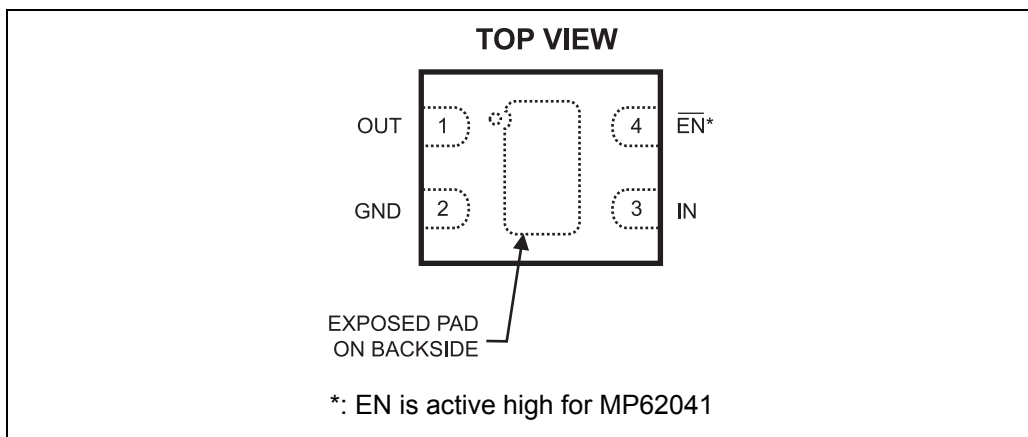

ABSOLUTE MAXIMUM RATINGS ⁽¹⁾

IN	-0.3V to +6.0V
EN, OUT to GND	-0.3V to +6.0V
Continuous Power Dissipation (T _A = +25°C) ⁽²⁾	
UTQFN40.7W
Continuous Drain Current	
T _A = +25°C	±2A
T _A = +85°C	±1.4A
Pulsed Drain Current ⁽³⁾	±6A
Continuous Diode Current ⁽⁴⁾	-50mA
Junction Temperature	150°C
Lead Temperature	260°C
Storage Temperature.....	-65°C to +150°C
Maximum Junction Temp. (T _J)	+125°C

<i>Thermal Resistance</i> ⁽⁵⁾	θ_{JA}	θ_{JC}
UTQFN4	173	127.. °C/W

Notes:

- Exceeding these ratings may damage the device.
- The maximum allowable power dissipation is a function of the maximum junction temperature T_J(MAX), the junction-to-ambient thermal resistance θ_{JA} , and the ambient temperature T_A. The maximum allowable continuous power dissipation at any ambient temperature is calculated by PD(MAX)=(T_J(MAX)-T_A)/ θ_{JA} . Exceeding the maximum allowable power dissipation will cause excessive die temperature, and the regulator will go into thermal shutdown. Internal thermal shutdown circuitry protects the device from permanent damage.
- Pulse width <300 μ s and duty cycle < 2%
- Continuous body diode conduction (reverse conduction) is not recommended.
- Measured on JESD51-7, 4-layer PCB.

ELECTRICAL CHARACTERISTICS ⁽⁶⁾
 $V_{IN}=3.6V$, $T_A=+25^{\circ}C$, unless otherwise noted.

Parameter	Symbol	Condition	Min	Typ	Max	Units
IN Voltage Range	V_{IN}		1.7		5.5	V
Supply Current		Device active, $I_{OUT}=0$		2		μA
Shutdown Current		Device disable, $V_{IN}=5.5V$, $V_{OUT}=float$			1	μA
FET On_Resistance		$V_{IN}=1.7V$, $I_{OUT}=100mA$		165	225	$m\Omega$
		$V_{IN}=1.8V$, $I_{OUT}=100mA$		155	215	$m\Omega$
		$V_{IN}=2.5V$, $I_{OUT}=100mA$		130	200	$m\Omega$
		$V_{IN}=3.6V$, $I_{OUT}=100mA$		100	140	$m\Omega$
		$V_{IN}=4.5V$, $I_{OUT}=100mA$		85	115	$m\Omega$
EN Input Logic High Voltage		$V_{IN} = 1.7V$ to $4.5V$, $I_D = -250\mu A$	1.2			V
EN Input Logic Low Voltage		$V_{IN} = 1.7V$ to $4.5V$, $I_D = -250\mu A$			0.4	V
EN Input Current		Device active, $V_{IN} = 5.5V$		2	4	μA
V_{OUT} Rising Time ⁽⁷⁾	T_r	$V_{IN}=3.6V$, $I_{OUT}=100mA$	75	115	200	μs
V_{OUT} Falling Time ⁽⁸⁾	T_f	$V_{IN}=3.6V$, $I_{OUT}=100mA$	65	75	100	μs
Turn On_Time ⁽⁹⁾	T_{on}	$V_{IN}=3.6V$, $I_{OUT}=100mA$		235	350	μs
Turn Off_Time ⁽¹⁰⁾	T_{off}	$V_{IN}=3.6V$, $I_{OUT}=100mA$		100	200	μs

Notes:

 6) Production test at $+25^{\circ}C$. Specifications over the temperature range are guaranteed by design and characterization.

7) Measured from 10% to 90%.

8) Measured from 90% to 10%.

9) Measured from (50%) EN signal to (90%) output signal.

10) Measured from (50%) EN signal to (10%) output signal.

PIN FUNCTIONS

UTQFN	Name	Description
1	OUT	IN-to-OUT Power-Distribution Output
2	GND	Ground and the thermal pad should both be connected to electrical ground.
3	IN	Input Voltage. Accepts 1.7V to 5.5V input.
4	$\overline{\text{EN}}$	Active Low: (MP62040), Active High: (MP62041)

PARAMETER MEASUREMENT INFORMATION

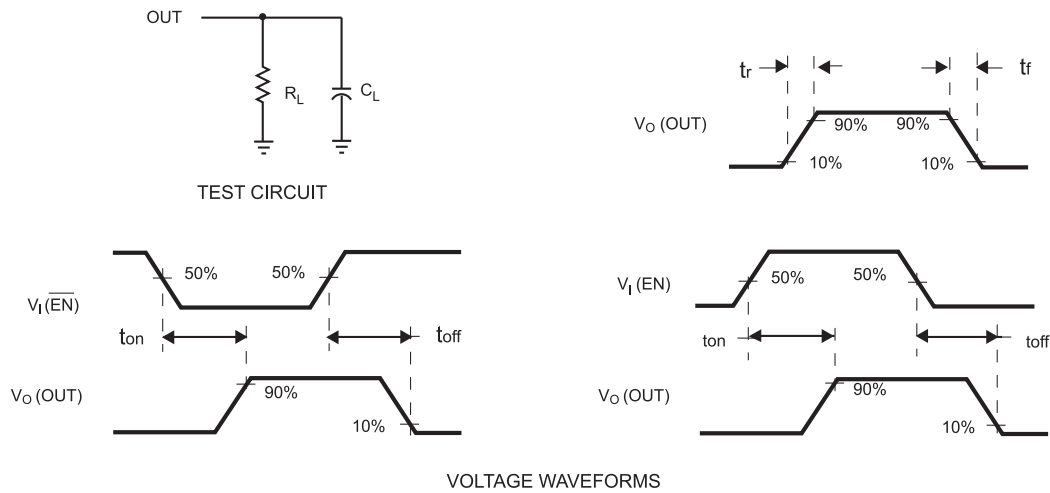
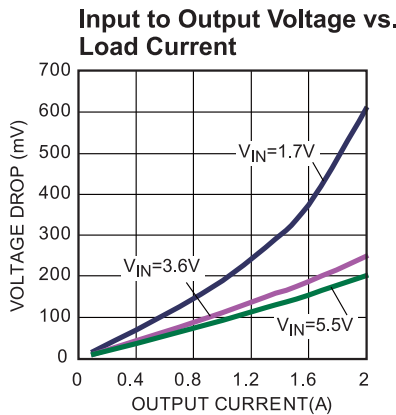
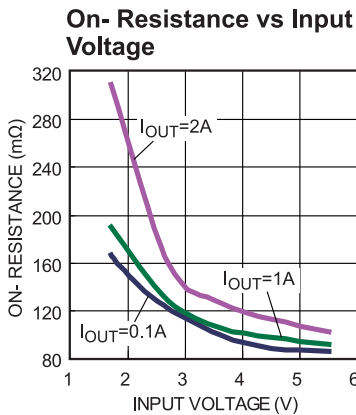
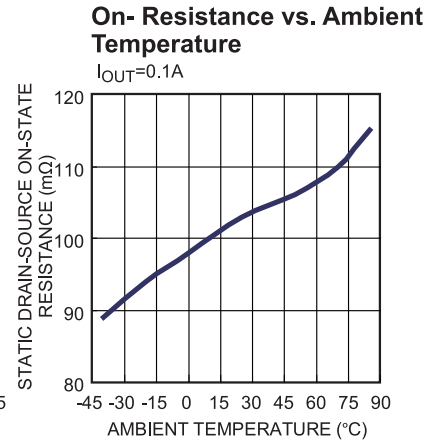
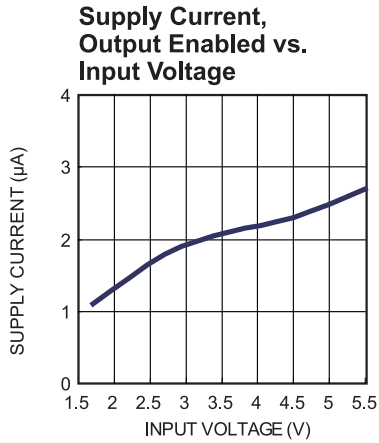
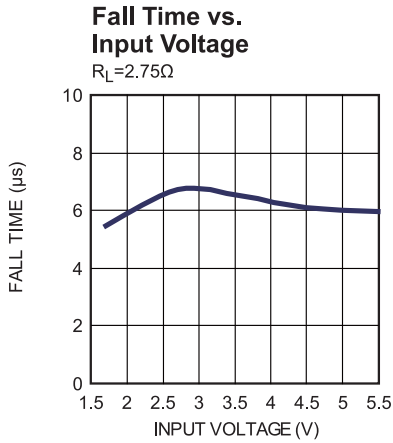
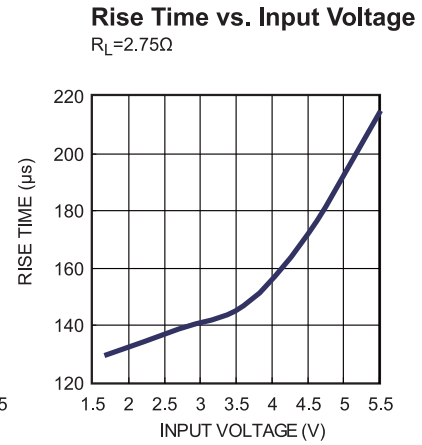
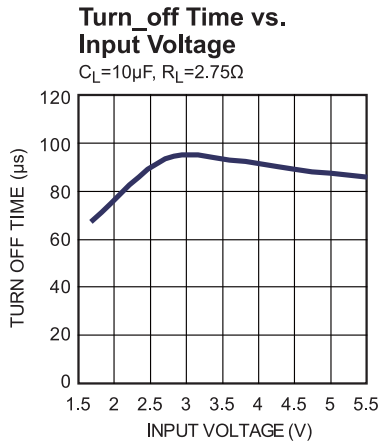
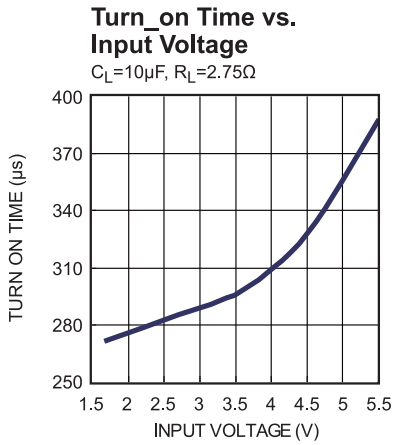

Figure1 — Definition of Tr, Tf, Ton, and Toff

TYPICAL PERFORMANCE CHARACTERISTICS

$V_{IN} = V_{EN} = 3.6V$, $C_L = 1\mu F$, $T_A = +25^\circ C$, unless otherwise noted.

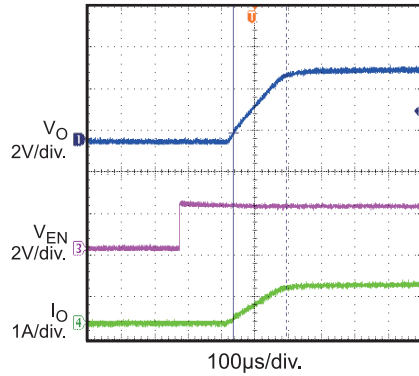
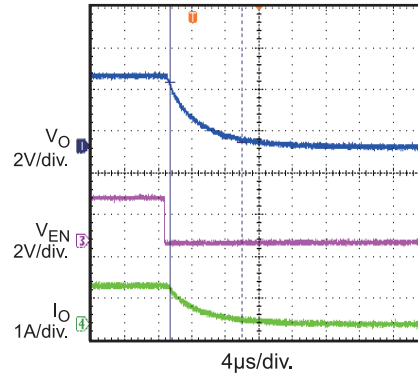
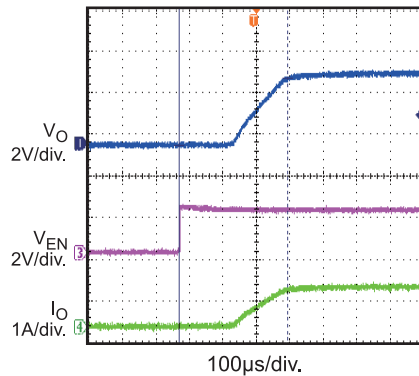
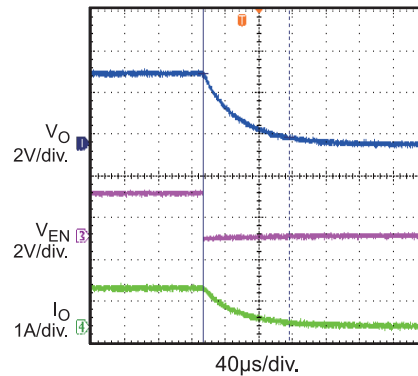

TYPICAL PERFORMANCE CHARACTERISTICS *(continued)*
 $V_{IN} = V_{EN} = 3.6V$, $C_L = 1\mu F$, $T_A = +25^\circ C$, unless otherwise noted.

**Turn_on Delay and Rise Time
with 1 μF Load**
 $R_L = 3.6\Omega$

**Turn_off Delay and Fall Time
with 1 μF Load**
 $R_L = 3.6\Omega$

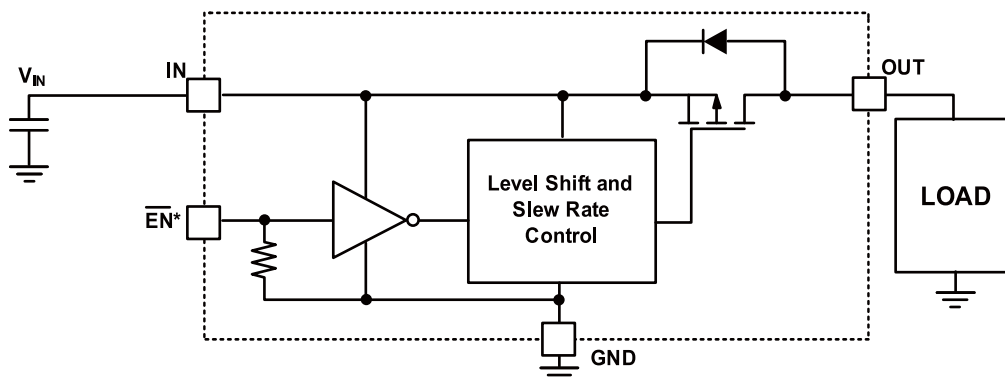
**Turn_on Delay and Rise Time
with 10 μF Load**
 $C_{OUT} = 10\mu F$, $R_L = 3.6\Omega$

**Turn_off Delay and Fall Time
with 10 μF Load**
 $C_{OUT} = 10\mu F$, $R_L = 3.6\Omega$

FUNCTION BLOCK DIAGRAM



(*: EN is active high for MP62041)

Figure 2 — Functional Block Diagram

DETAILED DESCRIPTION

The MP62040/MP62041 Power Distribution Switch is designed for high-side load switch. The switch operates from 1.7V to 5.5V nominal input voltage and can handle up to 2A continuous load.

Enable

The logic pin disables the switch to reduce overall supply current. Once the EN pin reaches logic enable threshold, the MP62040/MP62041 is enabled and the supply current is very small, only 2 μ A.

APPLICATION INFORMATION

Power-Supply Considerations

Over 10 μ F capacitor between IN and GND is recommended. This precaution reduces power-supply transients that may cause ringing on the input.

In order to achieve smaller output load transient ripple, placing a high-value electrolytic capacitor on the output pin(s) is recommended when the load is heavy.

PACKAGE INFORMATION

UTQFN (1.6x1.2mm)

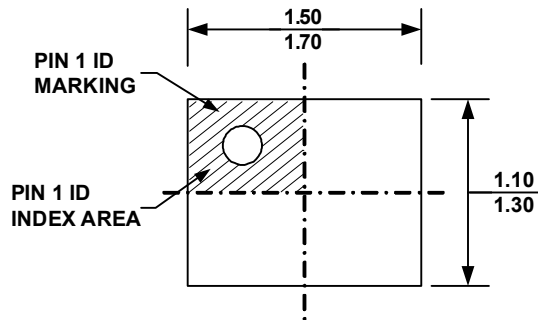

TOP VIEW

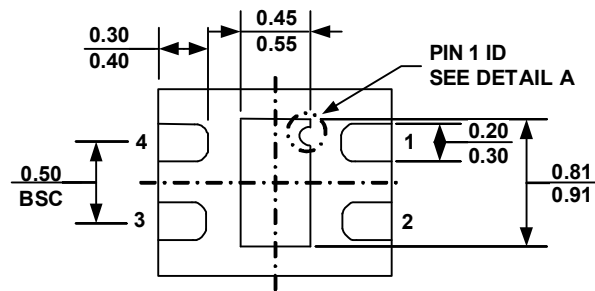

BOTTOM VIEW

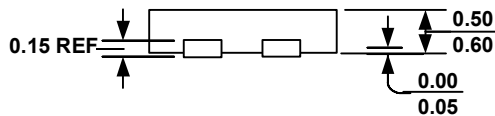

SIDE VIEW

PIN 1 ID OPTION A
R 0.10 TYP.

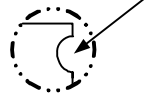

PIN 1 ID OPTION B
0.20x45° TYP.

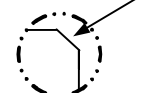

DETAIL A

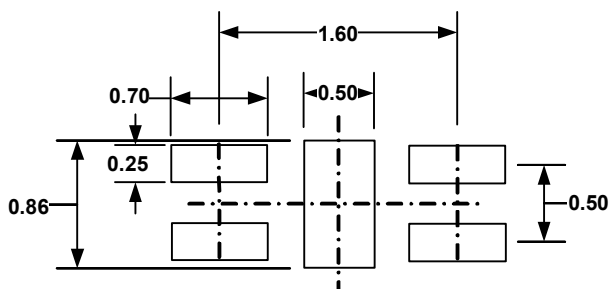

RECOMMENDED LAND PATTERN

NOTE:

- 1) ALL DIMENSIONS ARE IN MILLIMETERS
- 2) EXPOSED PADDLE SIZE DOES NOT INCLUDE MOLD FLASH
- 3) LEAD COPLANARITY SHALL BE 0.10 MILLIMETER MAX
- 4) JEDEC REFERENCE IS MO-229.
- 5) DRAWING IS NOT TO SCALE

NOTICE: The information in this document is subject to change without notice. Users should warrant and guarantee that third party Intellectual Property rights are not infringed upon when integrating MPS products into any application. MPS will not assume any legal responsibility for any said applications.