

### DESCRIPTION

The MP2480 is step-down switching regulator that delivers a constant current of up to 3A to high-power LEDs. It integrates a high-side, high-voltage power MOSFET with a current limit of 4.3A. The wide 5V to 36V input range accommodates a variety of step-down applications, making it ideal for general lighting and LCD backlighting applications. Hysteretic current-mode control helps provide for a very fast response, which makes the 20kHz dimming frequency possible. MPS's proprietary feedback control minimizes the number of external components while delivering an LED current with a typical accuracy of  $\pm 3\%$ .

The switching frequency goes up to 2MHz, thus permitting smaller components. Thermal shut down, and short circuit protection provide reliable fault-tolerant operation. A 160 $\mu$ A quiescent current allows for use in battery-powered applications.

The MP2480 is available in SOIC8-EP with an exposed pad on the bottom.

### FEATURES

- Wide 5V to 36V Operating Input Range
- Up to 95% Efficiency
- Hysteretic Control with No Compensation
- No Output Capacitor Required
- $\pm 3\%$  LED Current Accuracy
- Up to 2MHz Switching Frequency
- Up to 20kHz Dimming Frequency
- 200mV Reference Voltage
- Short-Circuit Protection with Integrated High-Side MOSFET
- Thermal Shut Down
- Available in SOIC8-EP

### APPLICATIONS

- High Power LED Driver
- General Lighting and LCD Backlighting
- Constant Current Source

All MPS parts are lead-free and adhere to the RoHS directive. For MPS green status, please visit MPS website under Quality Assurance. "MPS" and "The Future of Analog IC Technology" are Registered Trademarks of Monolithic Power Systems, Inc.

### TYPICAL APPLICATION

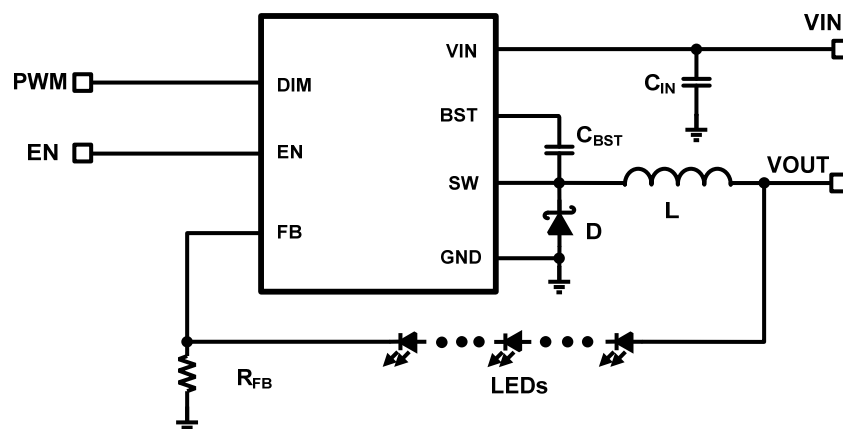

## ORDERING INFORMATION

Part Number	Package	Top Marking	Free Air Temperature (T <sub>A</sub> )
MP2480DN*	SOIC8-EP	MP2480	-40°C to +85°C

\* For Tape & Reel, add suffix -Z (e.g. MP2480DN-Z);  
 For RoHS compliant packaging, add suffix -LF (e.g. MP2480DN-LF-Z)

## PACKAGE REFERENCE

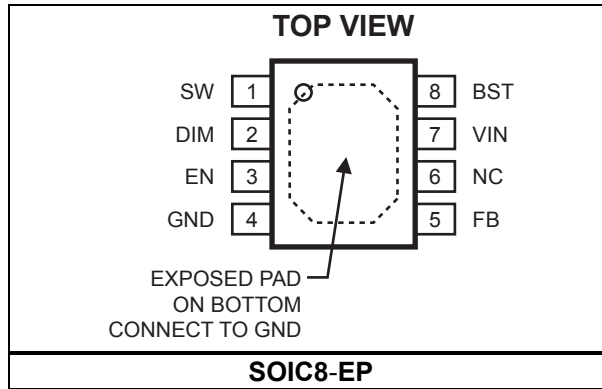

### ABSOLUTE MAXIMUM RATINGS <sup>(1)</sup>

Supply Voltage (V <sub>IN</sub> ).....	-0.3V to +40V
Switch Voltage (V <sub>SW</sub> ).....	-0.5V to (V <sub>IN</sub> + 0.5V)
BST to SW .....	-0.3V to +6V
All Other Pins .....	-0.3V to +6V
Junction Temperature .....	150°C
Continuous Power Dissipation (T <sub>A</sub> = 25°C) <sup>(2)</sup>	
SOIC8-EP .....	2.5W
Lead Temperature .....	260°C
Storage Temperature.....	-65°C to +150°C

### Recommended Operating Conditions <sup>(3)</sup>

Supply Voltage V <sub>IN</sub> .....	5V to 36V
EN and DIM Voltages .....	0V to 5V
Maximum Junction Temp. (T <sub>J</sub> ).....	125°C

### Thermal Resistance <sup>(4)</sup>

	θ <sub>JA</sub>	θ <sub>JC</sub>
SOIC8-EP .....	50	10 ... °C/W

**Notes:**

- 1) Exceeding these ratings may damage the device.
- 2) The maximum allowable power dissipation is a function of the maximum junction temperature T<sub>J</sub>(MAX), the junction-to-ambient thermal resistance θ<sub>JA</sub>, and the ambient temperature T<sub>A</sub>. The maximum allowable continuous power dissipation at any ambient temperature is calculated by P<sub>D</sub>(MAX)=(T<sub>J</sub>(MAX)-T<sub>A</sub>)/θ<sub>JA</sub>. Exceeding the maximum allowable power dissipation will cause excessive die temperature, and the regulator will go into thermal shutdown. Internal thermal shutdown circuitry protects the device from permanent damage.
- 3) The device is not guaranteed to function outside of its operating conditions.
- 4) Measured on JESD51-7 4-layer board.

## ELECTRICAL CHARACTERISTICS

$V_{IN} = 24V$ ,  $T_A = 25^\circ C$ , unless otherwise noted.

Specifications over temperature are guaranteed by design and characterization.

Parameter	Symbol	Condition	Min	Typ	Max	Units
VIN UVLO threshold			3.6	4.0	4.4	V
VIN UVLO hysteresis				0.4		V
Shutdown supply current		$V_{EN} = 0V$		2	5	$\mu A$
Quiescent supply current		No load, $V_{FB} = 250mV$		160	220	$\mu A$
Upper switch on resistance <sup>(5)</sup>	$R_{DS(ON)}$	$V_{BST} - V_{SW} = 5V$		150		m $\Omega$
Upper switch leakage current	$I_{SWLK}$	$V_{EN} = 0V$ , $V_{SW} = 0V$		0.01	1	$\mu A$
Current limit	$I_{PK}$	$V_{FB} = 0.15V$	3.5	4.3		A
EN up threshold	$V_{ENH}$		1.4	1.55	1.7	V
EN threshold hysteresis	$V_{ENHY}$			320		mV
EN input current	$I_{ENI}$	$V_{EN} = 5V$		0.01	1	$\mu A$
EN sinking current	$I_{ENS}$	$V_{EN} = 2V$		2	3	$\mu A$
DIM up threshold	$V_{DIMH}$		0.8	1.15	1.5	V
DIM threshold hysteresis	$V_{DIMHY}$			300		mV
DIM input current	$I_{DIM}$	$V_{DIM} = 5V$	-1		1	$\mu A$
		$V_{DIM} = 0V$	-5		-1	$\mu A$
Feedback voltage threshold high <sup>(5)</sup>	$V_{FBH}$	$5V < V_{IN} < 36V$ , $V_{FB}$ rising from 0V until $V_{SW} < 30V$	220	225	230	mV
Feedback voltage threshold low <sup>(5)</sup>	$V_{FBL}$	$5V < V_{IN} < 36V$ , $V_{FB}$ falling from 0.25V until $V_{SW} > 30V$	170	175	180	mV
FB pin input current	$I_{FB}$	$V_{FB} = 5V$ or $0V$	-100		100	nA
Max duty cycle <sup>(5)</sup>	$D_{MAX}$			98		%
Thermal shutdown <sup>(5)</sup>		Hysteresis = $20^\circ C$		150		$^\circ C$

**Note:**

5) Guaranteed by design.

## PIN FUNCTIONS

SOIC8-EP Pin #	Name	Description
1	SW	Switch Node. Output from the high-side switch. Requires a low- $V_F$ Schottky rectifier. Place the rectifier close to the SW pins to reduce switching spikes.
2	DIM	PWM Dimming Input. Pull this pin below the specified threshold to turn dimming off. Pull this pin above the specified threshold to turn dimming on. If there is no need for dimming, connect DIM and EN pins together.
3	EN	Enable Input. Pull this pin below the specified threshold to shutdown the chip. Pull this pin up above the specified threshold or leave it floating to enable the chip.
4	GND, Exposed pad	Ground. Connect as close as possible to the output capacitor. Avoid the high-current switching paths. Connect exposed pad to GND plane for optimal thermal performance.
5	FB	Feedback. Input to hysteretic comparators. Connect an external current sensing resistor in series with the LEDs to GND. Connects with the feedback voltage; regulated at +200mV with 25% ripple.
6	NC	Not connected
7	VIN	Input Supply. Supplies power to all the internal control circuitry, including both bootstrap regulators and the high-side switch. Place a decoupling capacitor to ground close to this pin to minimize switching spikes.
8	BST	Bootstrap. Positive power supply for the internal floating high-side MOSFET driver. Connect a bypass capacitor between this pin and SW pin.

**BLOCK DIAGRAM**

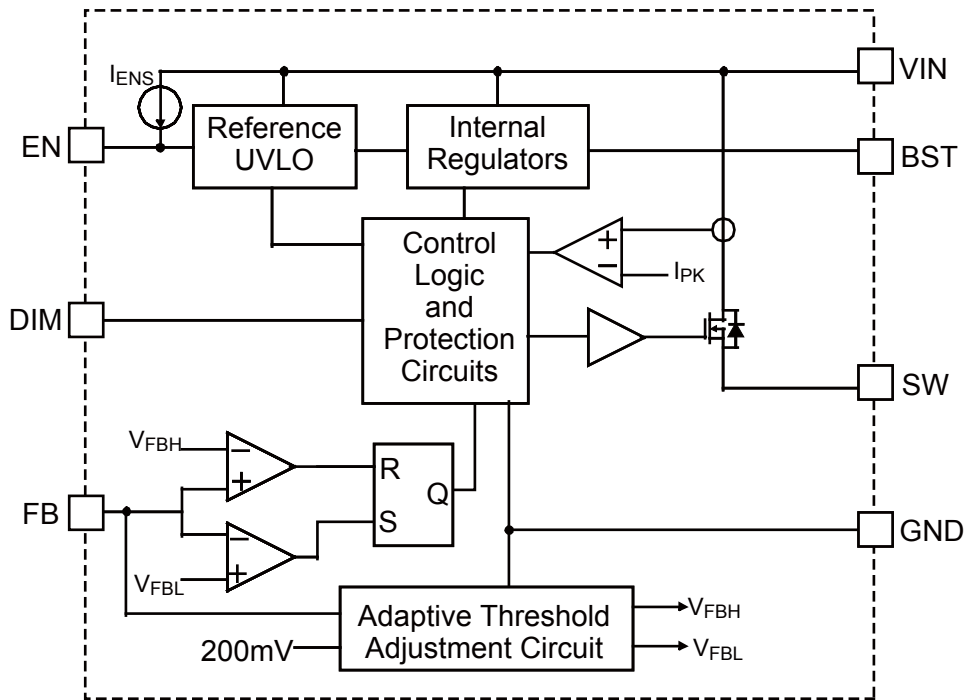

**Figure 1—Functional Block Diagram**

TYPICAL CHARACTERISTICS

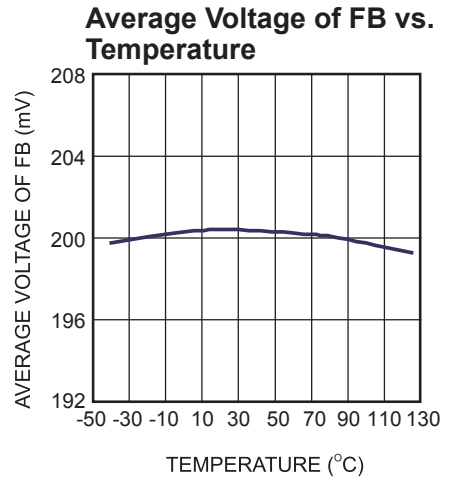
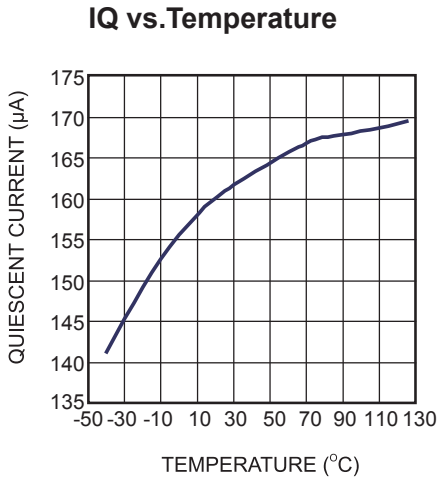
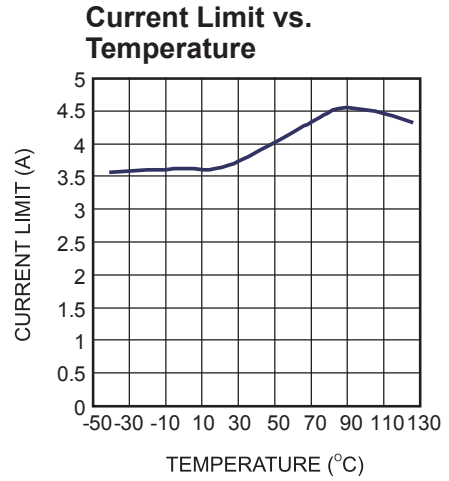
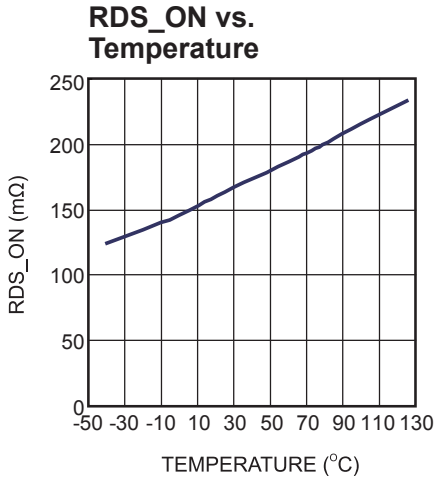

### TYPICAL PERFORMANCE CHARACTERISTICS

$L=47\mu\text{H}$ ,  $V_{\text{IN}}=30\text{V}$ ,  $I_{\text{LED}}=2\text{A}$ , 7 LED Load,  $T_{\text{A}}=25^{\circ}\text{C}$ , unless otherwise noted.

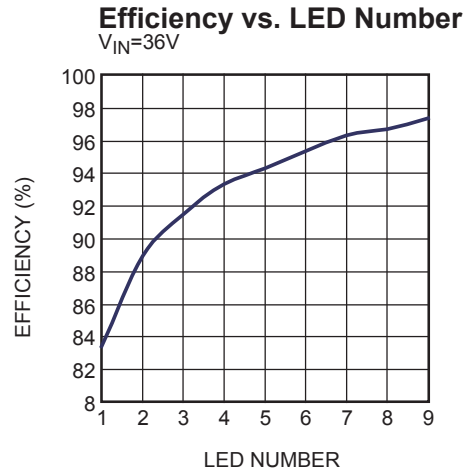
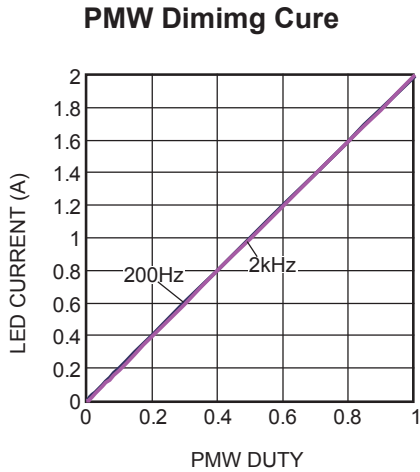

Steady State

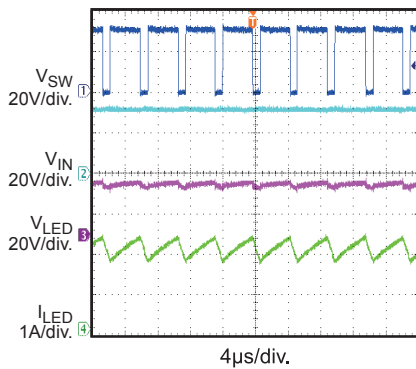

VIN Startup

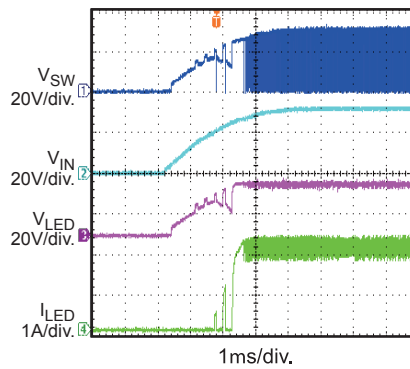

VIN Off

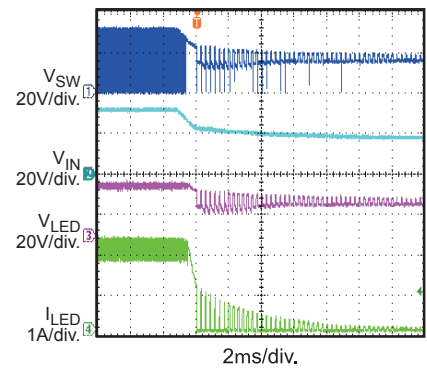

EN Startup

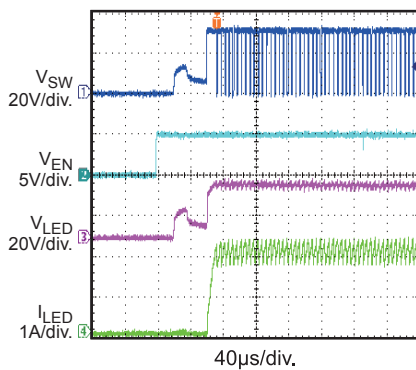

EN Off

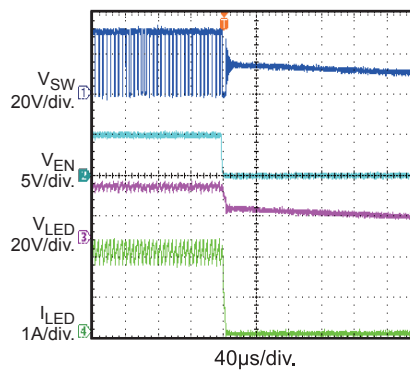

PWM Dimming

$f_{\text{PWM}} = 2\text{kHz}$ ,  $D_{\text{PWM}} = 50\%$

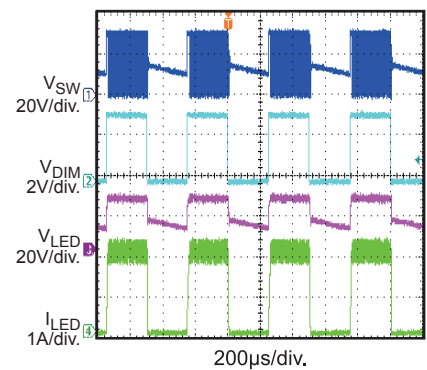

**TYPICAL PERFORMANCE CHARACTERISTICS** *(continued)*

$L=47\mu\text{H}$ ,  $V_{\text{IN}}=30\text{V}$ ,  $I_{\text{LED}}=2\text{A}$ , 7 LED Load,  $T_{\text{A}}=25^{\circ}\text{C}$ , unless otherwise noted.

**PWM Dimming**

$f_{\text{PWM}} = 200\text{Hz}$ ,  $D_{\text{PWM}} = 50\%$

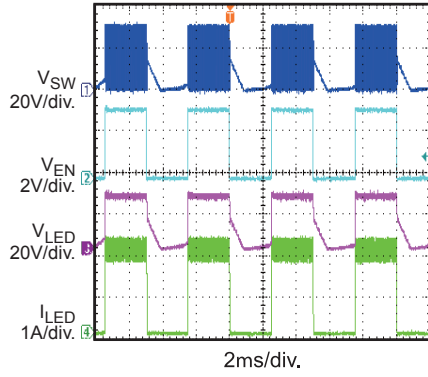

**Short LED+ to LED-**

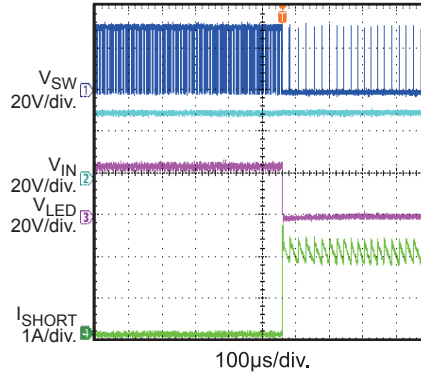

**Short LED+ to GND**

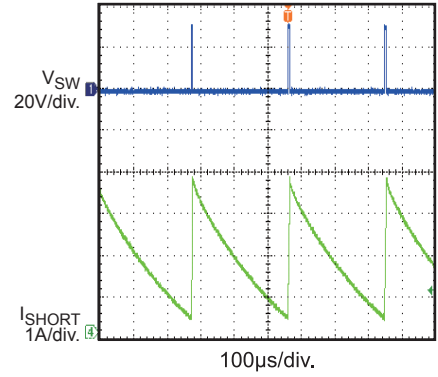



## OPERATION

### Hysteresis Current Control with Adaptive Threshold Adjustment

MP2480 operates in a hysteretic current-control mode to accurately regulate the LED current. The sensing resistor ( $R_{FB}$ ) connects to the FB pin to sense the LED current. The power MOSFET turns on and remains on until the voltage on the FB pin rises to the upper threshold of 225mV. The power MOSFET then turns off and remains off until FB pin falls to the lower threshold of 175mV. The two thresholds are adaptive and adjust to compensate for circuit delay. This regulates the LED current very accurately with an average of 200mV at the FB pin.

### Enable Control

The MP2480 has a dedicated enable-control pin (EN) with positive logic. Its falling threshold is 1.23V, and its rising threshold is 1.55V (320mV higher).

When floating, EN pulls up to about 3.0V by an internal 1 $\mu$ A current source so it is enabled. Pulling down a floating EN requires a current capability of 1 $\mu$ A..

### Floating Driver and Bootstrap Charging

The floating power MOSFET driver is powered by an external bootstrap capacitor. This floating driver has its own UVLO protection, with a rising threshold of 2.2V and a falling threshold of 150mV.

The dedicated internal bootstrap regulator charges and regulates the bootstrap capacitor to around 5V.

In case the internal circuit does not have sufficient voltage and the bootstrap capacitor has insufficient charge, extra external circuitry can ensure that the bootstrap voltage is in the normal operational region. Refer to External Bootstrap Diode in the Application section.

### Under-Voltage Lockout (UVLO)

Under-voltage lockout (UVLO) protects the chip from operating at insufficient supply voltage. The UVLO rising threshold is about 4.0V while its falling threshold is a consistent 3.6V.

### Thermal Shutdown

Thermal shutdown prevents the chip from operating at exceedingly high temperatures. When the silicon die temperature rises above its upper threshold, the chip shuts down. When the temperature falls below its lower threshold, the chip is enabled again.

### LED Short Protection

The LED current is within its limits and well-regulates while FB pin voltage is 200mV, as long as  $R_{FB}$  has not failed.

If the LED sensing resistor has failed or the output has shorted to GND, the voltage of FB pin falls.  $V_{IN}$  charges the inductor. When the inductor current reaches the current limit value, the power MOSFET turns off. MP2480 will retry the operation after about 300 $\mu$ s delay.

## APPLICATION INFORMATION

### COMPONENT SELECTION

#### Setting the LED Current

$R_{FB}$  is connected in series to the LEDs and sets the LED current,  $I_{LED}$ . The FB pin connects to the voltage on the sensing resistor  $R_{FB}$ , where.

$$I_{LED} = \frac{V_{FB}}{R_{FB}}$$

For example, for  $I_{LED} = 700\text{mA}$ ,  $R_{FB} = 286\text{m}\Omega$ .

#### Inductor Selection and Frequency Setting

The inductor  $L$  supplies a constant current to the LED. The inductor value is related to the switching frequency ( $f_s$ ) setting:

$$f_s = \frac{(V_{IN} - V_{OUT}) \cdot V_{OUT}}{V_{IN} \cdot L \cdot I_{LED} \cdot 25\%}$$

Where  $V_{IN}$  is the input voltage, and  $V_{OUT}$  is the output voltage that drives the LEDs. A larger-value inductor will result in smaller switching frequency.

The peak inductor current is about:

$$I_{LP} = I_{LED} \cdot 1.125$$

Choose an inductor that will not saturate under the maximum inductor peak current.

#### Output Rectifier Diode

The output rectifier diode supplies the current to the inductor when the high-side switch is off. To reduce losses due to the diode's forward voltage and recovery times, use a Schottky diode.

The RMS current through the diode is about:

$$I_D = I_{LED} \cdot \sqrt{1 - \frac{V_{OUT}}{V_{IN}}}$$

Choose a diode with a maximum reverse voltage rating greater than the maximum input voltage, and a current rating greater than the maximum diode current.

#### Input Capacitor $C_{IN}$

The input current to the step-down converter is discontinuous, and therefore requires a capacitor to supply the AC current to the step-down converter and maintain the DC input voltage. Use low-ESR capacitors for best performance, especially for high-switching-frequency applications.

The RMS current through the input capacitor is about:

$$I_D = I_{LED} \cdot \sqrt{\frac{V_{OUT}}{V_{IN}}}$$

With low ESR capacitors, the input voltage ripple can be estimated as:

$$\Delta V_{IN} = \frac{I_{LED}}{f_s \times C_{IN}} \times \frac{V_{OUT}}{V_{IN}} \times \left(1 - \frac{V_{OUT}}{V_{IN}}\right)$$

Choose the input capacitor with a high-enough RMS current rating and enough capacitance for a small input-voltage ripple.

Include a small high-quality ceramic capacitor (0.1 $\mu\text{F}$ ) placed as close to the IC as possible when using electrolytic or tantalum capacitors.

#### Output Capacitor $C_{OUT}$

The output capacitor ( $C_{OUT}$ ) is not necessary to reduce the LED ripple current: The LED ripple current (peak-to-peak value) is about 15% of the LED DC current. However, the output capacitor can be used to further reduce the LED ripple current. Use low-ESR capacitors to limit the output ripple voltage. The output ripple voltage can be estimated by:

$$\Delta V_{OUT} = \frac{V_{OUT}}{f_s \times L} \times \left(1 - \frac{V_{OUT}}{V_{IN}}\right) \times \left(R_{ESR} + \frac{1}{8 \times f_s \times C_{OUT}}\right)$$

Where  $R_{ESR}$  is the equivalent series resistance (ESR) value of the output capacitor.

### External Bootstrap Diode

An external bootstrap diode may enhance the efficiency of the LED driver. For the cases listed below, add an external BST diode is from a 5V rail to the BST pin:

- There is a 5V rail available in the system;
- $V_{IN} \leq 5V$ ;
- $3.3V < V_{OUT} < 5V$ ;

Add a diode for high duty cycle operations (when  $V_{OUT}/V_{IN} > 65\%$ ), and for very-high-frequency (over 1.5MHz) applications.

The bootstrap diode can be low-cost, such as a IN4148 or BAT54.

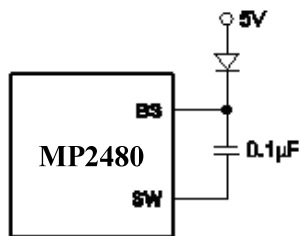

Figure 2—External Bootstrap Diode

### Layout Consideration

Place the input decoupling capacitors and the catch diode as close to MP2480 ( $V_{IN}$  pin, SW pin and PGND) as possible, with short, wide traces. This reduces the voltage spike on the SW node and lowers the EMI noise level.

Run the feedback trace as far away from the inductor and noisy power traces as possible. Try to run the feedback trace on the opposite side of the PCB to the inductor, with a ground plane separating the traces from the inductor.

To improve thermal conduction, create a grid of thermal vias right under the exposed pad. Use small vias (15mil barrel diameter) so that the holes fill during the plating process. Very large holes can cause 'solder-wicking' problems during the reflow soldering process. Use a pitch (distance between the centers) of around 40mil to space the vias.

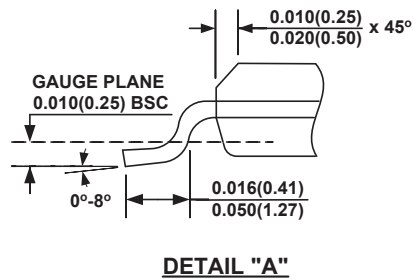
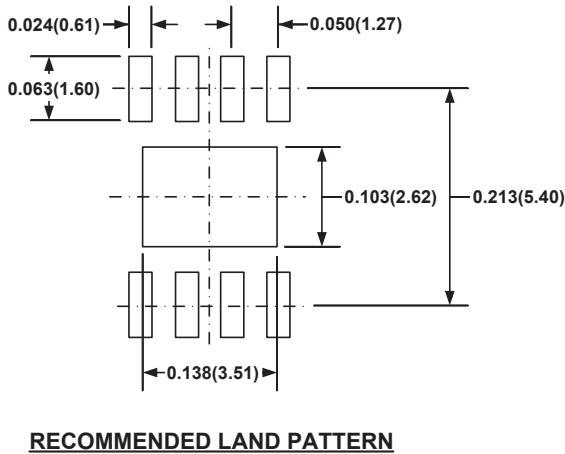
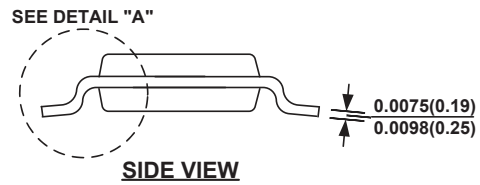
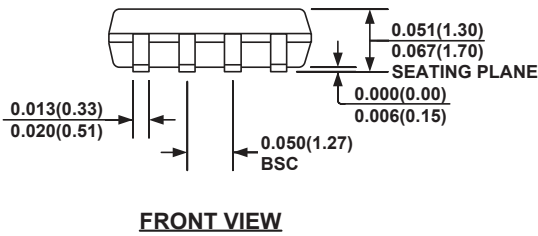
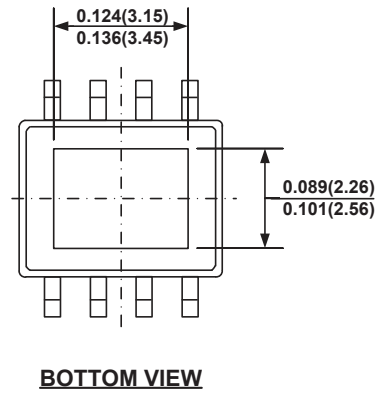
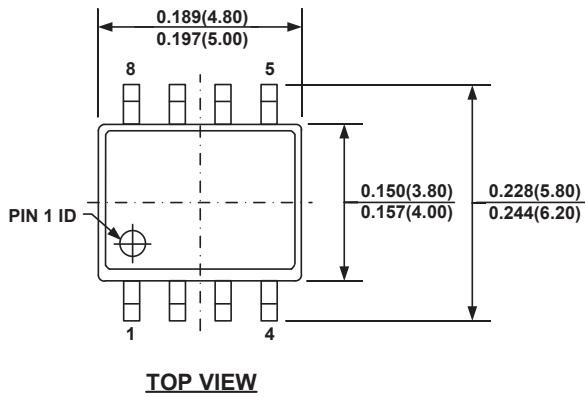
**PACKAGE INFORMATION**
**SOIC8-EP**

**NOTE:**

- 1) CONTROL DIMENSION IS IN INCHES. DIMENSION IN BRACKET IS IN MILLIMETERS.
- 2) PACKAGE LENGTH DOES NOT INCLUDE MOLD FLASH, PROTRUSIONS OR GATE BURRS.
- 3) PACKAGE WIDTH DOES NOT INCLUDE INTERLEAD FLASH OR PROTRUSIONS.
- 4) LEAD COPLANARITY (BOTTOM OF LEADS AFTER FORMING) SHALL BE 0.004" INCHES MAX.
- 5) DRAWING CONFORMS TO JEDEC MS-012, VARIATION BA.
- 6) DRAWING IS NOT TO SCALE.

**NOTICE:** The information in this document is subject to change without notice. Users should warrant and guarantee that third party Intellectual Property rights are not infringed upon when integrating MPS products into any application. MPS will not assume any legal responsibility for any said applications.