

DESCRIPTION

The **MMP742038-24** is part of a family of smart motor control boards for servo motor applications. This design is capable of delivering 38W continuous power, and is designed to fit NEMA 17 format, 42mm motors.

The board features: an embedded angular sensor; FOC control; selectable position, speed, and torque loop mode; and RS485 and PULSE/DIR input interfaces.

Easy-to-use GUI software provides flexibility by allowing users to optimize the design online through the RS485 control interface. The parameters are saved in the control board's non-volatile memory.

Users can also order a complete motor (**MSM942038-24**). A datasheet for the MSM942038-24 is available for download at www.monolithicpower.com.

FEATURES

- 18V to 36V Input Voltage Range
- Max 38W Continuous Power Output
- 0.3° Position Resolution
- RS485 Interface and PULSE/DIR Interface
- Position Control and Speed Control
- Operating Temperature: 0°C to 70°C (Power Derated > 40°C)
- Storage Temperature: -40°C to +125°C

ORDERING INFORMATION

Part Number	MMP742038-24-C
Diameter (mm)	42
Power (W)	38
Typical Voltage (V)	24
Control Mode	Speed/Position
Interface	RS485, PULSE/DIR

RECOMMENDED OPERATING CONDITIONS

Input voltage..... 18V to 36V
 Control interface voltage..... 0V to 5.5V
 Max pulse frequency 500kHz
 RS485 A/B voltage 0V to 5.5V
 RS485 common mode voltage ±15V
 Operation temperature 0°C to 70°C
 Storage temperature -40°C to +125°C

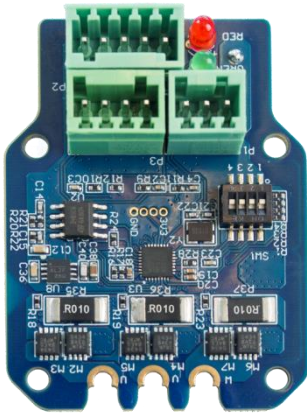

Figure 1: Motor Control PCBA

Motor Control Board			
Parameters	Condition	Value	Units
Input voltage		24	V
Output power	0°C to 40°C	38	W
Position resolution		0.3	°

INSTALLATION OF PCB ASSEMBLY IN SMART MOTOR

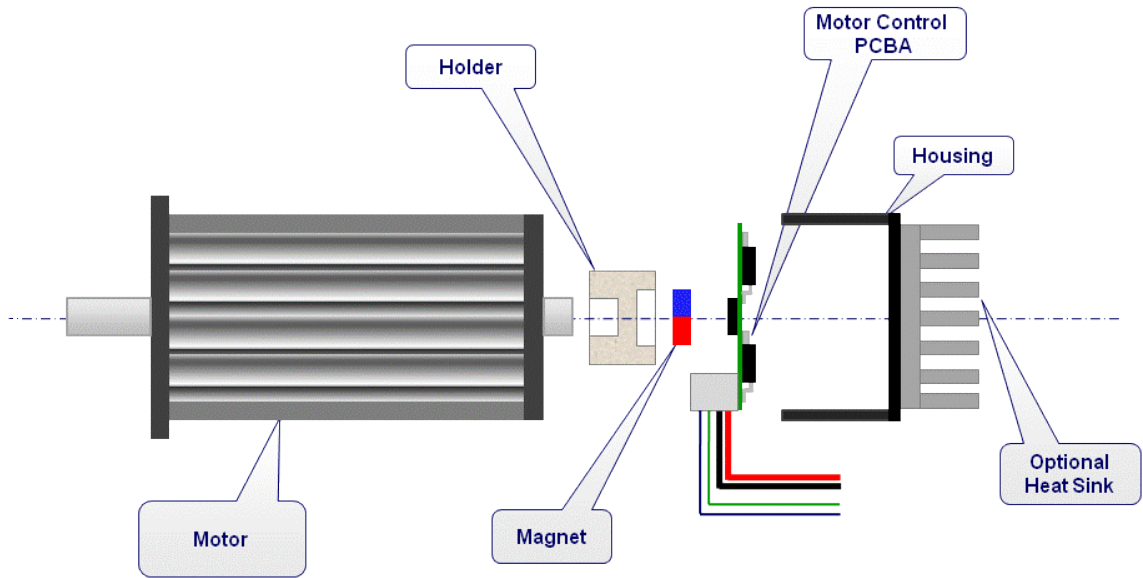

Figure 2: Smart Motor PCB Assembly

The motor control PCB assembly can be installed into a motor (see Figure 2). Users can manufacture their own control board housing and magnet holder based on the actual motor dimensions. MPS will supply the magnet.

Table 1 shows some examples of recommended magnets for use with the MMP module. A sintered NdFeB or SmCo magnet of a 6mm to 8mm diameter and 2.5mm to 3mm height with remanent field strength in the 1.0T to 1.2T range is recommended (see Figure 3). The diameter of the magnet depends on the specific motor shaft and holder design used. It is important that the magnetization is diametrically polarized.

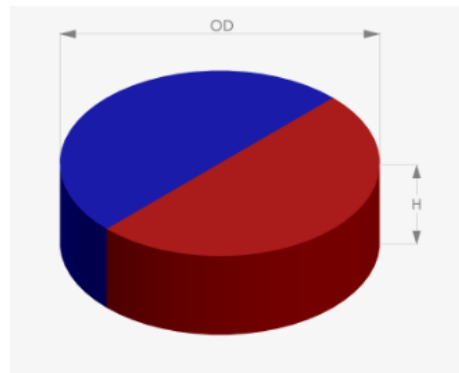

Figure 3: Magnet Height and Diameter

The magnet air gap spacing to the sensor surface should be set to achieve a field strength between 30mT min and 80mT max (see Figure 4). The MPS magnetic simulation tool at <http://sensors.monolithicpower.com/> can be used to find the correct air gap spacing for the particular magnet used.

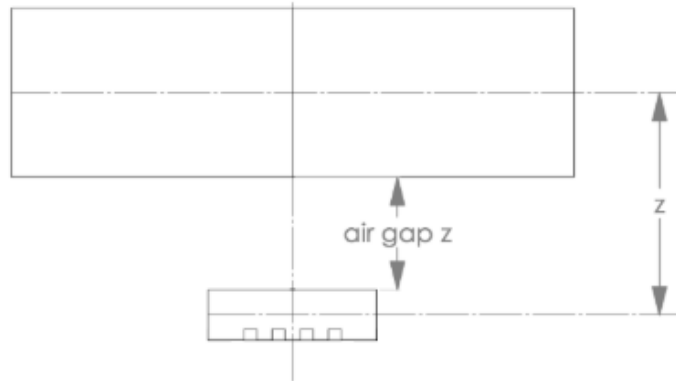

Figure 4: Magnet Air Gap Spacing

Table 1 shows the recommended minimum and maximum air gap spacing for the suggested magnets.

Table 1: Recommended Magnet Specifications

OD (mm)	H (mm)	Material	Remanence (Br) (T)	Magnetization	Recommended “Air Gap Z” Min/Max (mm)
6.0	2.5	N35	1.2	Diametrical	1.5 to 3.5
6.0	2.5	Sm26/16	1.08	Diametrical	1.3 to 3.3
6.0	3.0	N35	1.2	Diametrical	1.8 to 3.8
6.0	3.0	Sm26/16	1.08	Diametrical	1.5 to 3.6
8.0	2.5	N35	1.2	Diametrical	1.8 to 4.5
8.0	2.5	Sm26/16	1.08	Diametrical	1.5 to 4.1
8.0	3.0	N35	1.2	Diametrical	2.1 to 4.8
8.0	3.0	Sm26/16	1.08	Diametrical	1.8 to 4.5

The choice between neodymium or samarium cobalt material depends on the target motor’s end application. Neodymium magnets are strong and resistant to demagnetization, but samarium cobalt magnets have a higher working temperature range and better corrosion resistance.

Choosing the right holder material is important. It should be a nonmagnetic material such as aluminum, brass, or plastic so as not to influence or distort the sensor magnet’s field. The user can determine the attachment method to the shaft based on the design criteria for the motor. To avoid detachment due to the different coefficients of thermal expansion for the magnet, holder, and shaft, use of a high-temperature industrial adhesive is recommended.

The magnet holder requires a motor with a shaft that extends from the rear of the motor. Contact the individual motor supplier to discuss options for shaft diameter and length. This will determine the required holder size and housing depth.

The PCB housing design should take into account any heatsinking requirements for the motor driver components, additional bulk motor supply capacitance, and EMC filtering as needed to meet the target application’s specifications. The housing should center the central angle sensor IC to align to the motor shaft magnet holder with no more than $\pm 0.4\text{mm}$ of axial misalignment.

HARDWARE CONNECTION FOR PROGRAMMING SMART MOTOR

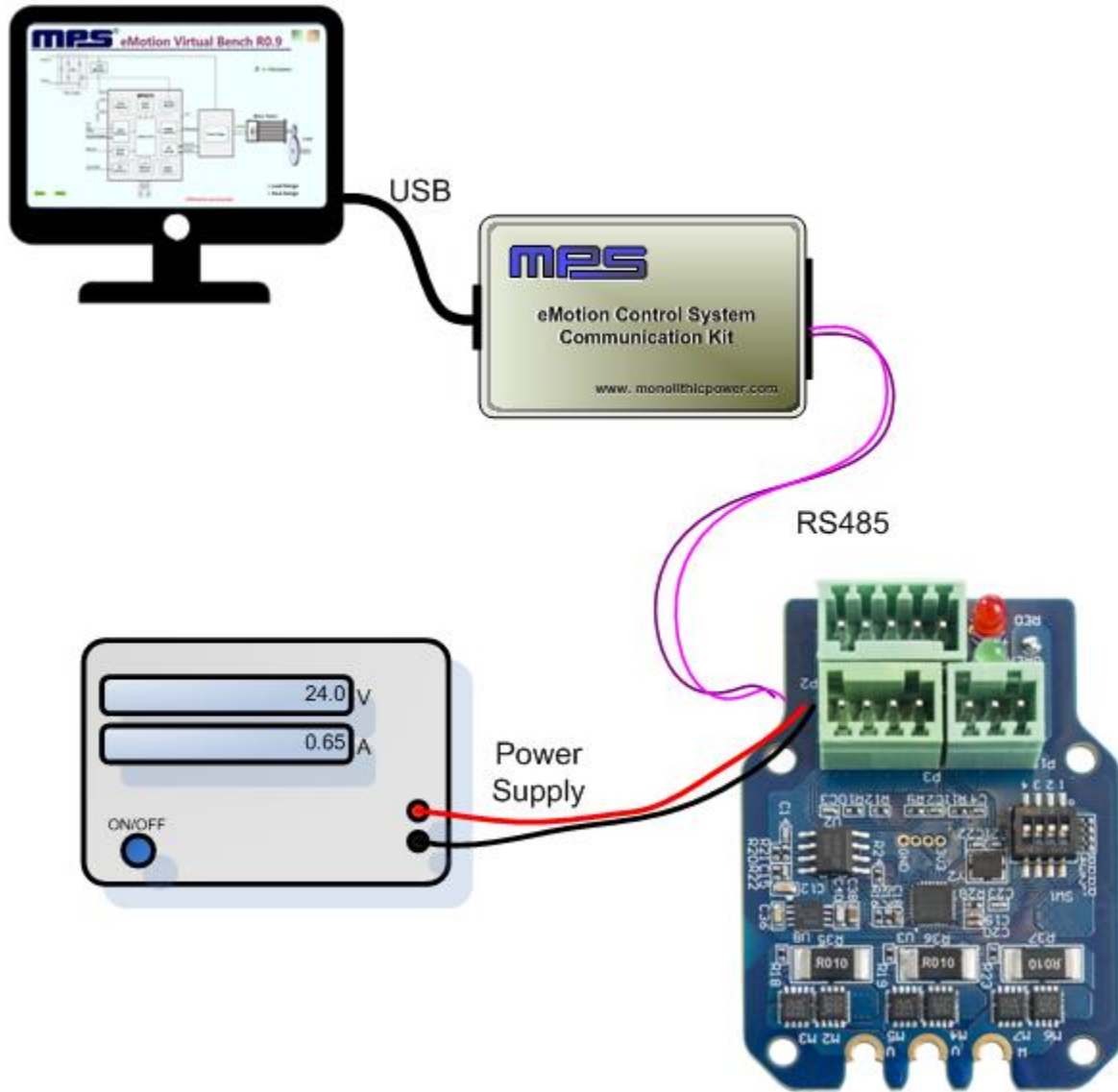

PIN CONFIGURATION

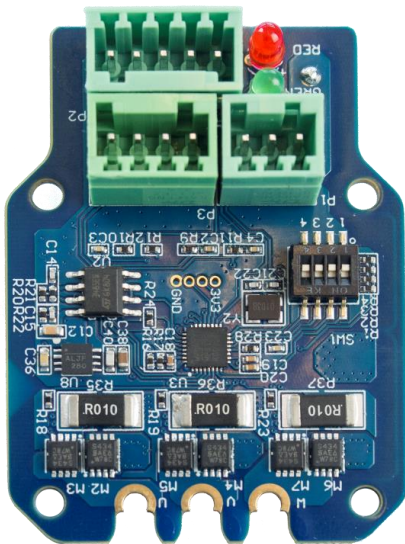
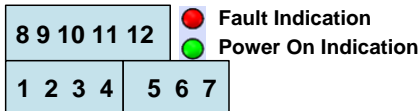

Pin Number	Designation	Pin Description
RS485 Interface		
1	EXT_5V	5V input for firmware programming
2	B	RS485 node B
3	AGND	RS485 ground
4	A	RS485 node A
Power Interface		
5	GND	Power ground
6	R-	Shunt resistor return node
7	VIN	Input power supply
Control Interface		
8	COM-	Common return
9	EN+	Enable input
10	PEND+	Position end output
11	PUL+	Pulse input
12	DIR+	Direction input

TYPICAL PERFORMANCE CHARACTERISTICS

T_A = 25°C, V_{IN} = 24V, unless otherwise noted.

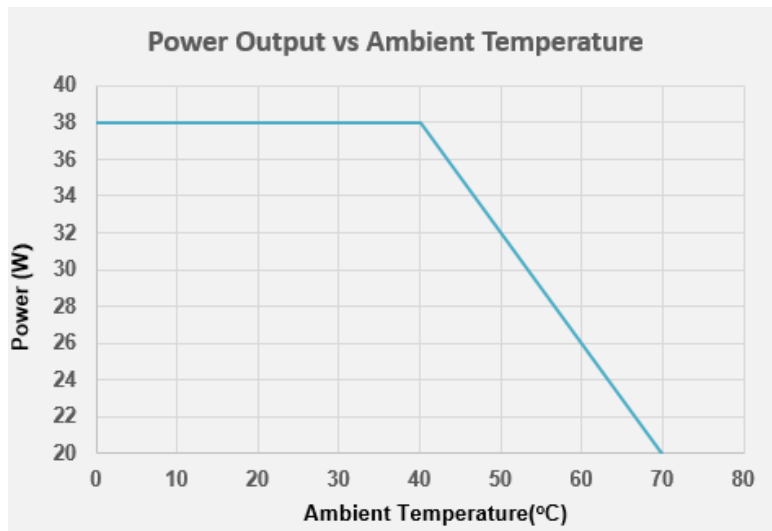

DRIVER MODULE MECHANICAL DRAWING

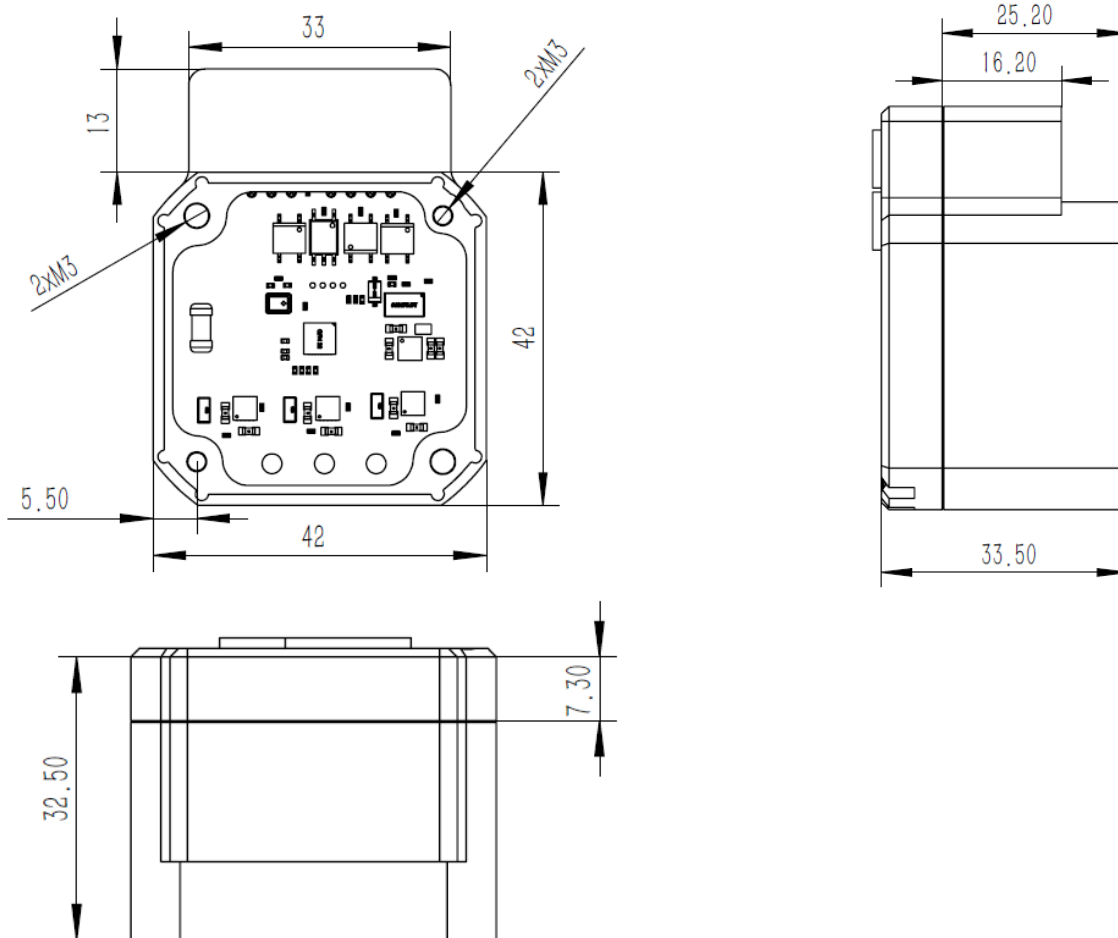

Note that no housing is supplied with the MMP742038-24 PCB.

The above drawings are for illustration only, and are based on dimensions for a NEMA 17 format motor. Contact the individual motor supplier for the particular mounting hole positions and dimension information.