

DWG. NO. SD-54363-038

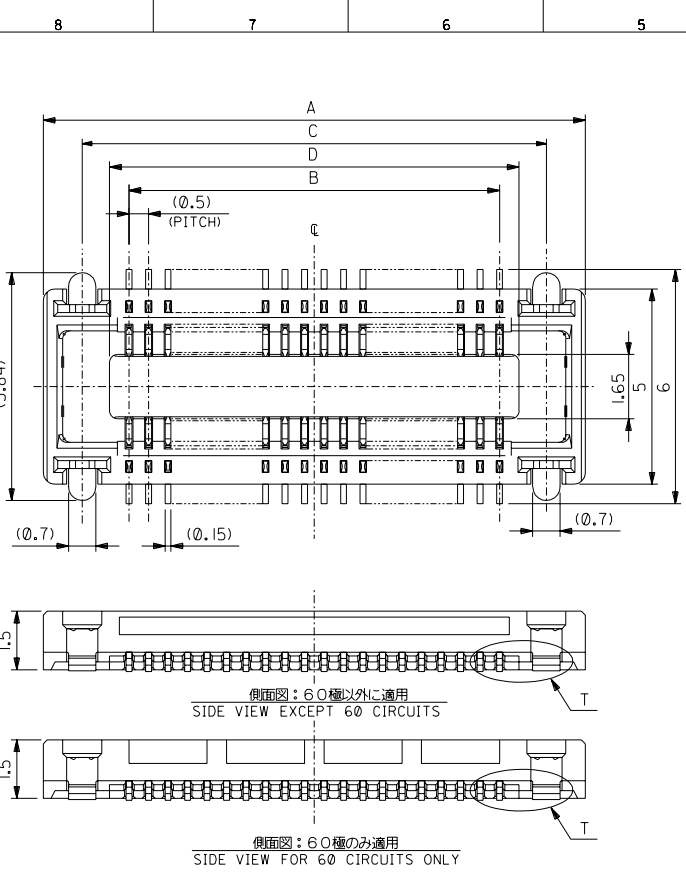

注記 NOTES:

1. 材質 MATERIAL  
ハウジング: LCP (液晶ポリマー)、ガラス充填、黒色、UL94V-0  
HOUSING: LCP (LIQUID CRYSTAL POLYMER), GLASS FILLED, BLACK, UL94V-0  
ターミナル: 銅合金 (t=0.15)  
TERMINAL: COPPER ALLOY (t=0.15)  
ネイル: 銅合金 (t=0.2)  
NAIL: COPPER ALLOY (t=0.2)
2. メッキ仕様 PLATING  
ターミナル TERMINAL  
接点部: 金メッキ 0.25マイクロメートル以上  
CONTACT AREA: GOLD 0.25 MICROMETER MINIMUM  
半田付テール: 金メッキ 0.4マイクロメートル以下  
SOLDER TAIL AREA: GOLD 0.4 MICROMETER MAXIMUM  
下地メッキ: ニッケルメッキ 1.5マイクロメートル以上  
UNDER PLATING: NICKEL 1.5 MICROMETER MINIMUM  
ネイル NAIL  
銅メッキ 3.0マイクロメートル以上  
Solder 3.0 MICROMETER MINIMUM  
下地メッキ: ニッケルメッキ 1.0マイクロメートル以上  
UNDER PLATING: Ni 1.0 MICROMETER MINIMUM
3. テール平坦度は、0.08ミリメートル以下。テールとネイルを併せた平坦度は、0.1ミリメートル以下。  
TAIL COPPLANARITY TO BE 0.08 MAXIMUM. TAILS AND NAILS COPPLANARITY TO BE 0.1 MAXIMUM.
4. 嵌合相手: 55299-\*\*\*\* (H=3mm)  
MATED CONN.: 55299-\*\*\*\* (H=3mm)  
55201-\*\*\*\*, 55650-\*\*\*\* (H=2mm)
5. この製品は54363-\*\*01, (エンボス梱包品 54363-\*\*08)の給付品です。  
THIS PRODUCT IS 'LEAD FREE' OF 54363-\*\*01, (EMBOSSED TAPE PKG 54363-\*\*08)

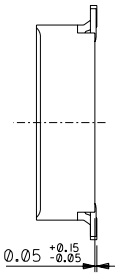

側面図: 60極以外に適用  
SIDE VIEW EXCEPT 60 CIRCUITS

側面図: 60極のみ適用  
SIDE VIEW FOR 60 CIRCUITS ONLY

40.5	41.9	39.5	43.9	54363-1678	54363-1671	160	—
35.5	36.9	34.5	38.9	54363-1478	54363-1471	140	○
30.5	31.9	29.5	33.9	54363-1278	54363-1271	120	○
28	29.4	27	31.4	54363-1178	54363-1171	110	○
25.5	26.9	24.5	28.9	54363-1078	54363-1071	100	○
23	24.4	22	26.4	54363-0978	54363-0971	90	—
20.5	21.9	19.5	23.9	54363-0878	54363-0871	80	○
18	19.4	17	21.4	54363-0778	54363-0771	70	○
15.5	16.9	14.5	18.9	54363-0678	54363-0671	60	○
13	14.4	12	16.4	54363-0578	54363-0571	50	○
10.5	11.9	9.5	13.9	54363-0478	54363-0471	40	○
8	9.4	7	11.4	54363-0378	54363-0371	30	○
5.5	6.9	4.5	8.9	54363-0278	54363-0271	20	○

D	C	B	A	エンボス梱包品 EMBOSSED TAPE PACKAGING	製品番号 MATERIAL NO.	極数 CIRCUITS	量産対応 AVAILABLE
				SCALE 10-1	DESIGN UNITS <input checked="" type="checkbox"/> mm <input type="checkbox"/> INCH	THIRD ANGLE PROJECTION	DIMENSIONS: <input type="checkbox"/> mm <input type="checkbox"/> INCH <input type="checkbox"/> mm ONLY
GENERAL TOLERANCES: (UNLESS SPECIFIED) 一般公差				DRAWN BY & DATE A. Iida '04/01/06	TITLE: 0.5 mm PITCH B/B CONN. REC. HOUSING ASS'Y (H=2,3mm) WITH FITTING NAIL -LEAD FREE-		
FINISH 仕上げ 注記参照 SEE NOTES				CHECKED BY & DATE S. Takaya '04/01/06	APPROVED BY & DATE M. Iida '04/01/06		
WIRE RANGE 適用電線範囲				ANGLE 角度	MATERIAL NO. DRAWING NO. SHEET NO. SD-54363-038.S01 SEE CHART SD-54363-038 1 OF 2		
INS. RANGE 被覆外径				THIS DRAWING CONTAINS INFORMATION THAT IS PROPRIETARY TO MOLEX INCORPORATED AND SHOULD NOT BE USED WITHOUT WRITTEN PERMISSION.			

DO NOT SCALE DRAWING

EC NO. DRWN: CHK: APPR:	EC NO. DRWN: CHK: APPR:	EC NO. DRWN: CHK: APPR:	REVISED ECNNO. J2004-2225 DRWN: A. IIDA '04/02/02 CHK: H. TAKASE APPR: M. IYAZAWA, Y. ITO	RELEASED ECNNO. J2004-1740 DRWN: A. IIDA '04/01/06 CHK: H. TAKASE APPR: M. IYAZAWA, Y. ITO	MATERIAL 材料 注記参照 SEE NOTES
FINISH 仕上げ 注記参照 SEE NOTES					
WIRE RANGE 適用電線範囲					
INS. RANGE 被覆外径					

EN-02J(097) MXJ-54

DWG. NO. SD-54363-038

8 7 6 5 4 3 2 1

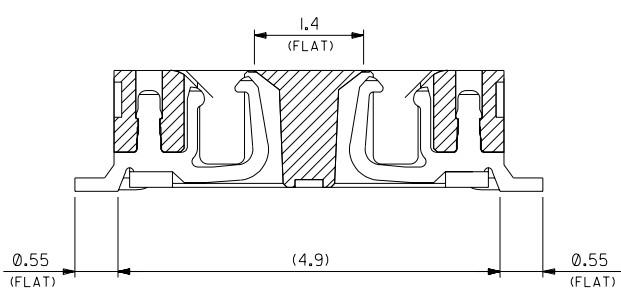

製品断面図 (半田付け部、吸着面寸法)  
DETAIL FOR SOLDERING AND VACUUM AREA

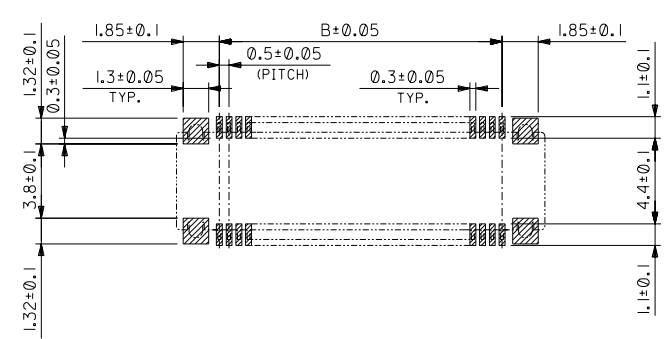

推奨基板寸法  
RECOMMENDED PCB PATTERN LAYOUT  
(SCALE:5-1)

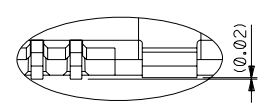

寸法詳細  
DETAIL T

DO NOT SCALE DRAWING

EC NO. DRWN: CHK: APPR:	EC NO. DRWN: CHK: APPR:	EC NO. DRWN: CHK: APPR:	EC NO. DRWN: CHK: APPR:	SEE SHEET 1 OF 2 EC NO. DRWN: CHK: APPR:	DESCRIPTION MATERIAL 材料 注記参照 SEE NOTES FINISH 仕上付 注記参照 SEE NOTES WIRE RANGE 適用電線範囲 INS. RANGE 被覆外径	GENERAL TOLERANCES: (UNLESS SPECIFIED) 一般公差 10 UNDER 未満 +0.2 10 OVER 以上 30 UNDER 未満 +0.25 30 OVER 以上 +0.3 ANGLE 角度 +3°	SCALE 20-1 DESIGN UNITS <input checked="" type="checkbox"/> mm <input type="checkbox"/> INCH DRAWN BY & DATE A. Iida '04/01/06 CHECKED BY & DATE S. Takase '04/01/06 APPROVED BY & DATE M. Yamada '04/01/06 CAD FILENAME SD-54363-038.S02	THIRD ANGLE PROJECTION DIMENSIONS: <input type="checkbox"/> mm <input type="checkbox"/> INCH <input checked="" type="checkbox"/> mm ONLY TITLE: 0.5 mm PITCH B/B CONN. REC. HOUSING ASS'Y (H=2,3mm) WITH FITTING NAIL -LEAD FREE-	MATERIAL NO. SEE CHART DRAWING NO. SD-54363-038 SHEET NO. 2 SIZE B	SHT REV REVISE ON CAD ONLY
8	7	6	5	4	3	2	1	EN-02J(097) MXJ-54		

DWG. NO. SD-54363-039

8 7 6 5 4 3 2 1

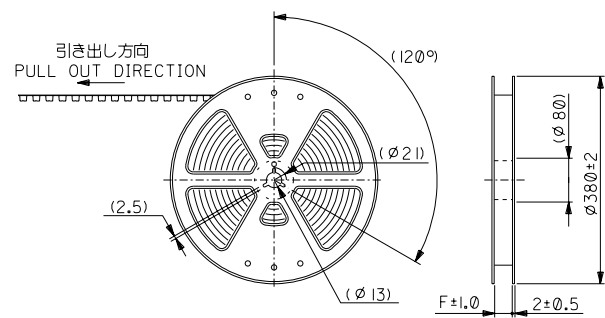

注) NOTES

- 製品番号 54363-\*\*\*71 詳細寸法については、製品単体図面を参照下さい。  
IN THE PACKAGE PART NUMBER 54363-\*\*\*71 DETAILED DIMENSIONS, SEE SALES DRAWING FOR CONNECTOR.
- 梱包数量: 2500個/リール  
NUMBER OF CONNECTORS: 2500 PCS/REEL.
- リードテープ長さ  
LEAD TAPE LENGTH

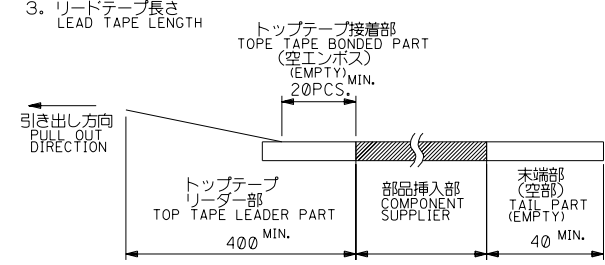

- トップテープの剥離強度: (剥離方向は下図参照)  
PEELING OFF FORCE OF TOP TAPE (PELLING DIRECTION AS SHOWN IN FOLLOWING FIGURE.)  
0.1~1.3N (10~130gf)

尚、本規格値は、出荷時に適用。  
THIS REQUIREMENT SHOULD BE APPLIED AT SHIPMENT.  
(但し、輸送時に剥離が発生しない事。)  
(PEEL OFF SHOULD NOT BE ALLOWED, DURING TRANSPORTATION.)

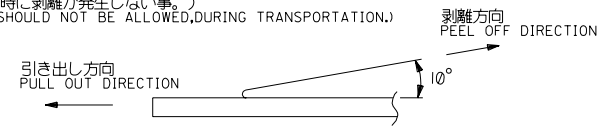

- 材料  
MATERIAL  
キャリアテープ: ポリプロピレン (PP)  
CARRIER TAPE: POLYPROPYLENE (PP)  
トップテープ: PET, PE, PEF  
TOP TAPE: PET, PE, PEF  
リール: ポリスチレン  
REEL: POLYSTYRENE
- この製品は54363-\*\*\*01, (エンボス梱包品 54363-\*\*\*08)の鉛フリー品です。  
THIS PRODUCT IS 'LEAD FREE' OF 54363-\*\*\*01, (EMBOSSED TAPE PKG 54363-\*\*\*08)

DO NOT SCALE DRAWING

EC NO. DRWN: CHK: APPR:		EC NO. DRWN: CHK: APPR:		EC NO. DRWN: CHK: APPR:		REVISED ECNNO. J2004-2225 DRWN: A.IDA '04/02/02 CHK: H.TAKASE APPR: MIYAZAWA, YO.ITO		RELEASED ECNNO. J2004-1740 DRWN: A.IDA '04/01/06 CHK: H.TAKASE APPR: MIYAZAWA, YO.ITO		MATERIAL 材料 注記参照 SEE NOTES		GENERAL TOLERANCES: (UNLESS SPECIFIED) — 一般公差		SCALE NONE		DESIGN UNITS <input checked="" type="checkbox"/> mm <input type="checkbox"/> INCH		THIRD ANGLE PROJECTION		DIMENSIONS: <input type="checkbox"/> mm <input type="checkbox"/> INCH <input checked="" type="checkbox"/> mm ONLY		SHT REV	
						A		0		FINISH 仕上げ 注記参照 SEE NOTES		10 未満 +0.2		DRAWN BY & DATE A. Iida '04/01/06		TITLE: 54363-***71 TAPING PACKAGE -LEAD FREE-							
										WIRE RANGE 適用電線範囲		10 OVER 以上 30 未満 +0.25		CHECKED BY & DATE S. Takase '04/01/06		MOLEX INCORPORATED							
										INS. RANGE 被覆外径		30 OVER 以上 +0.3		APPROVED BY & DATE Y. Ito '04/01/06		CAD FILENAME SD-54363-039.S01		MATERIAL NO. SEE CHART		DRAWING NO. SD-54363-039		SHEET NO. 1 OF 2	
												ANGLE 角度		±3°		THIS DRAWING CONTAINS INFORMATION THAT IS PROPRIETARY TO MOLEX INCORPORATED AND SHOULD NOT BE USED WITHOUT WRITTEN PERMISSION.				SIZE B			
																				EN-02J(097) MXJ-54			

DWG. NO. SD-54363-039

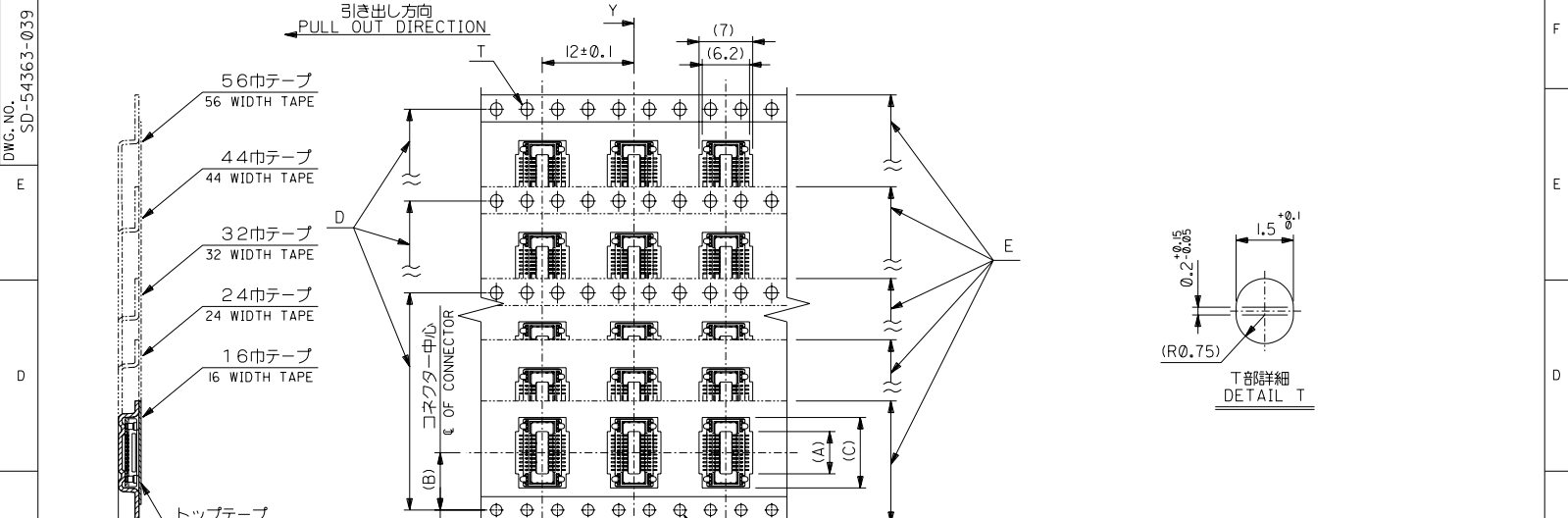

57.5	56±0.3	52.4	44.2 39.2 34.2	26.2	40.55 35.55	54363-1678 54363-1478	160 140	— ○
45.5	44±0.3	40.4	31.7 29.2 26.7 24.2	20.2	28.05 25.55 23.05 20.55	54363-1178 54363-1078 54363-0978 54363-0878	110 100 90 80	○ ○ — ○
33.5	32±0.3	28.4	21.7 19.2	14.2	18.05 15.55	54363-0778 54363-0678	70 60	○ ○
25.5	24±0.3	—	16.7 14.2 11.7	11.5	13.05 10.55 8.05	54363-0578 54363-0478 54363-0378	50 40 30	○ ○ ○
17.5	16±0.3	—	9.2	7.5	5.55	54363-0278	20	○

DO NOT SCALE DRAWING		SEE SHEET 1 OF 2		MATERIAL FINISH		GENERAL TOLERANCES: UNLESS SPECIFIED		SCALE: NONE		DESIGN UNITS: mm		THIRD ANGLE PROJECTION		DIMENSIONS: mm		SHT: 2		REV: 1	
EC NO.	DRWN:	CHK:	APPR:	EC NO.	DRWN:	CHK:	APPR:	10 UNDER	+0.2	DRAWN BY & DATE	TITLE: 54363-***71 TAPING PACKAGE -LEAD FREE-		MATERIAL NO. 54363-0278		CIRCUITS 20		量産対応 AVAILABLE		
EC NO.	DRWN:	CHK:	APPR:	EC NO.	DRWN:	CHK:	APPR:	10 OVER	+0.25	CHECKED BY & DATE	MATERIAL NO. SEE CHART		DRAWING NO. SD-54363-039		SHEET NO. 2		SIZE B		
EC NO.	DRWN:	CHK:	APPR:	EC NO.	DRWN:	CHK:	APPR:	30 OVER	+0.3	APPROVED BY & DATE	MATERIAL NO. SEE CHART		DRAWING NO. SD-54363-039		SHEET NO. 2		SIZE B		
WIRE RANGE		INS. RANGE		ANGLE		CAD FILENAME		THIS DRAWING CONTAINS INFORMATION THAT IS PROPRIETARY TO MOLEX INCORPORATED AND SHOULD NOT BE USED WITHOUT WRITTEN PERMISSION.		MATERIAL NO. SEE CHART		DRAWING NO. SD-54363-039		SHEET NO. 2		SIZE B			