

**Power Products**

Typical Terminal Styles.....	S-2
Quick Disconnects.....	S-3
Specialty Connectors.....	S-4
Terminal Blocks	
Beau® Eurostyle.....	S-5 to S-8
Barrier Strips.....	S-9 to S-12
Beauplug® Plugs and Sockets.....	S-13 to S-15
Wire Splice Terminal.....	S-15
Wire Management Products.....	S-15
Heavy-Duty Rectangular Industrial Connectors	
HMC™.....	S-16 to S-21
Mini-HMC™.....	S-22

**Sealed Connector Systems**

MX150L™.....	S-23 to S-24
XRC™.....	S-25 to S-27

**Automation Connectivity**

Brad® Nano-Change® (M8).....	S-28 to S-30
Brad Micro-Change® (M12).....	S-31 to S-40
Brad Ultra-Lock® (M12).....	S-34 to S-35
BradConnectivity™ mPm® Connectors.....	S-41
Brad Mini-Change®.....	S-42 to S-50
BradPower™.....	S-51 to S-54
BradConnectivity™ M23 Signal and Power Connectors.....	S-55
Network Protocols	
DeviceNet*.....	S-56 to S-63
PROFIBUS.....	S-64 to S-67
Ethernet.....	S-68 to S-74
Woodhead® Grips.....	S-75 to S-77

**I/O Connectors**

Commerical Micro-D.....	S-78
-------------------------	------

\* DeviceNet is a trademark of Open DeviceNet Vendor Association (ODVA)

Visit [www.molex.com](http://www.molex.com) to access more part numbers and product information, download sales drawings, product specifications, 3D models, place sample requests, and more.

# Typical Styles

## Standard Ring Tongue

The ring tongue terminal is the safest and most reliable style because it cannot be disconnected unless the screw is completely removed.

The basic Molex barrel, called Krimptite®, is noninsulated and features a quality, one-piece design. It is also the most economical style and has the greatest variety of uses where special features are not required.

The InsulKrimp® version features a rigid insulation sleeve of PVC affixed to the Krimptite barrel or the brazed-seam VersaKrimp™ barrel. It attaches to the wire with one quick crimp and the insulation sleeve protects against vibration damage by preventing wire flex at the crimp point. The funnel entrance into the barrel eliminates wire strand

“fold back,” increases crimping rates and enhances wire termination reliability.

When the butted-seam Krimptite barrel is bonded with a special brazing alloy, it becomes a VersaKrimp barrel. These brazed-seam barrel terminals will not open under conditions of stress or wire pull. As versatile as it is tough, it can be crimped under most adverse conditions by many types of tooling. The VersaKrimp is ideal for hard-to-crimp solid and stranded wires.

The NylaKrimp® barrel was designed specifically for larger wire applications. The color-coded barrel is formed by affixing a permanent, rigid, color-coded nylon insulating sleeve to the barrel. The insulation has a funnel entrance

into the barrel that eliminates wire strand “fold back,” increases crimping rates and enhances wire termination.

AviKrimp® terminals with color-coded barrels offer you the ultimate in high-performance terminal design and rugged construction. The Tin-plated Brass sleeve strengthens the barrel and secures the wire to protect against stress and high vibration. The color-coded nylon insulating sleeve extends beyond the metal support sleeve. A funnel ferrule wire entrance into the barrel prevents wire strand “fold back” for increased crimping rates and added wire termination reliability in the standard barrel length.

### Features

- Material: Copper
- Available in wire ranges from 24 to 26 AWG to 4/0
- All parts available loose piece; some are also available on mylar tape carrier



## Splices

Molex offers standard and special splices for nearly every type of wiring needed.

### Butt Splice

Stripped wires are inserted from each end and “butt” in the center, then a crimp at each end secures the connection.



### Step Down Butt Splice

The perfect solution when two wires need to be inserted in one end of a splice and a single wire in the other end.



### Parallel Splice

Stripped wires lie side-by-side in the splice and are secured by a single crimp in the middle.



### AviKrimp Butt Splice

With the extra metal sleeve and nylon insulation, these splices should be used when heavy vibration is anticipated and a strong strain relief is needed.



### Funnel Entry Butt Splice

With the funnel entry butt splice, the end that will be crimped by the crimping press is funneled to allow quick and easy wire insertion.



### Window Butt Splice

The unique feature of this splice is the “window” that is stamped into the copper splice and covered by nylon. The inspection window guarantees proper wire insertion and crimp tool alignment. QPL'd to Mil-T-7928/5



### Multi-Lock

This is an insulation displacement connector that allows tap-and-run connections. Using only ordinary channel lock pliers, these color-coded connectors make quick, reliable, preinsulated splices without having to strip, twist or solder.



### Nylon Closed End Connector

The nylon closed end connectors are used in a wide variety of situations to “pigtail” or tie together two or more wires.



### Wire Tap

The Wire Tap splices onto a wire using an insulation displacement barb. No special tools are required, simply squeeze together with pliers.



Note: The connectors shown here are only a representation of our product line. For a complete listing of all solderless terminals and connectors, please contact Molex Industrial Division at 1-800-800-0449, or at [www.molex.com](http://www.molex.com).

# Quick Disconnects

## Quick Disconnect Terminals For PC Board

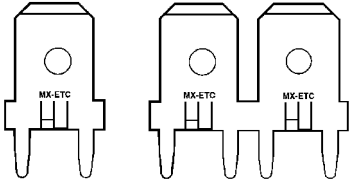

Molex offers a large selection of Standard Printed Circuit Board Mountable quick disconnect terminals. Some products offer a tab support mounting feature providing increased mounting reliability and terminal strength. Products are available as strip applied and loose piece. All products can be easily inserted into printed circuit boards using widely available, industry standard bench-type and fully-automated XY insertion tooling.

Molex PC board Quick Disconnect terminals are available in tab sizes ranging from 2.79 by 0.51 mm (.110 by .020") to 6.35 by 0.81 mm (.250 by .032"). Products are available in both vertical and right angle mounting configurations. All products are manufactured to NEMA specifications and are UL and CSA recognized.

### Features

Material: Brass  
Tab conforms to NEMA specifications  
Plating: Tin 3.81µm (150µ") min. thickness

## Fully-Insulated Quick Disconnects

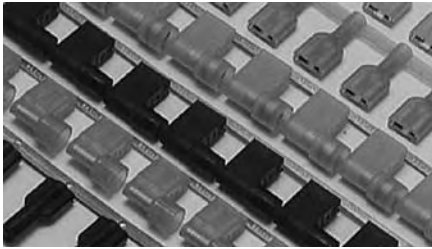

### Features

- Meets UL 310 standards (listed under UL File No. E79133)
- Color coded translucent insulator allows easy identification of terminal size and wire gauge
- Funnel entrance designed for increased crimping rates by speeding wire delivery into crimp section and eliminating wire strand fold back
- Wire stop stamped into the crimp barrel prevents insertion of over-stripped wire
- Avikrimp version has extra advantage of the secure metal support sleeve, and fulfills double crimp (support) requirements of VDE and DIN specifications
- The right angle flag terminal provides space saving design
- All parts available as loose piece; most are also available on either mylar tape, metal strip, and/or continuous molded carrier
- Some parts meet the UL 94V-0 flammability rating

## Fully-Insulated Piggyback Quick Disconnects

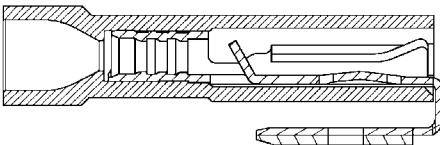

### Features

- Same functions as a standard piggyback terminal with the added feature of being fully insulated with a rigid nylon housing
- Also available in expanded flare versions
- Available in InsulKrimp (single crimp) or Avikrimp (double crimp) style
- Also available in barrel insulated InsulKrimp and Avikrimp versions



## Tape-fed And Loose-piece Quick Disconnects

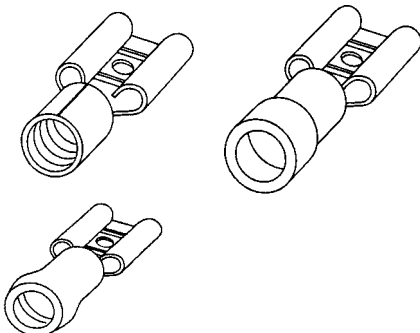

These non-insulated and partially insulated quick disconnects are available either loose piece or tape-mounted. Loose piece versions are individually fed into the dies of manual and powered hand crimping tools. Tape-fed versions are the same terminals mounted on mylar tape for automatic feeding into air- or electric-powered bench crimping presses.



Tape-fed terminals are ideal for applications where there are too many terminals for hand tool crimping and too few for strip press crimping. All loose piece and tape-fed terminals have a fully Tin-plated Brass construction with closed electrical barrels.

Parts are available in the following styles: Krimptite (buted seam), InsulKrimp (PVC insulated), and Avikrimp (nylon insulated with vibration support).

Note: The connectors shown here are only a representation of our product line. For a complete listing of all solderless terminals and connectors, please contact Molex at 1-800-800-0449, or at [www.molex.com](http://www.molex.com).

# Specialty Connectors

## Perma-Seal™ Terminals and Splices

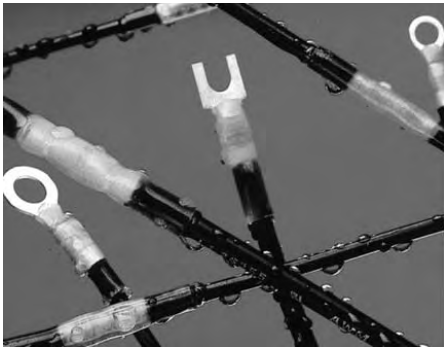

Perma-Seal terminals and splices provide a rugged, environmentally sealed connection for wire sizes 8 to 22 AWG that will insulate, seal and protect joints from physical abuse and abrasion, water, salt and other corrosive compounds.

These terminals give you long-lasting, moisture-proof connections that withstand water, salt, corrosion and heat, all of which cause serious problems for conventional, unsealed splices. The inner wall of the heat-shrinkable insulation sleeve is lined with a special hot-melt adhesive that is inert at room temperature, permitting wires to be inserted easily into the splices and terminals. As the sleeve is heated, the adhesive melts and flows under pressure from the tubing. This action creates a voidless seal that repels moisture incursion even during pressure cycling, and stands up to some of the most rigorous tests that can be applied to high-performance splices, such as the salt fog test MIL-T-7928.

The tough insulation sleeve of Perma-Seal splices and terminals resists abrasion and cutting. This protection helps to maintain the insulation and sealing properties even in the most hostile environments, inside and out.

## Heavy-Duty Copper Lugs and Splices

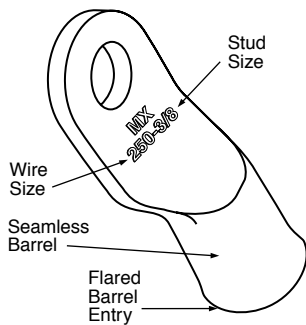

Our heavy-duty closed end crimpable terminals are designed for electrical and industrial applications such as welding equipment, forklifts, generators, power distribution equipment, motors, etc. They are manufactured of pure electrolytic copper, and are available in 8 AWG through 4/0 AWG wire and cable with a variety of stud sizes.

### Features

- Rated to 35KV applications
- UL listed, CSA certified
- Crimps in industry standard tooling
- Seamless barrel design
- Can be easily soldered or crimped
- Flared barrel entry for easy wire insertion
- AWG wire size identification on barrel
- Made of CDA-110 Copper stock offering 100% conductivity

## Star Ring Terminals



The Star Ring is a serrated ring that is mainly used for grounding. Unlike a ring terminal, when you tighten down on a star ring, the "star blades," or serrated edges, actually pierce through paint or other coatings, and bite into the metal to insure a good connection or ground. The product may also eliminate the need for lock washers.

### Features

Material: Brass or Steel

Non-insulated, PVC insulated, or nylon insulated

Wire ranges from 18 to 22 AWG and 14 to 16 AWG

Note: The connectors shown here are only a representation of our product line. For a complete listing of all solderless terminals and connectors, please contact Molex at 1-800-800-0449, or at [www.molex.com](http://www.molex.com).

# Eurostyle™ PCB Terminal Blocks

## Fixed, One Piece or Pluggable, Two Piece

Molex manufactures a wide variety of Eurostyle terminal blocks to fit your connector needs.

Whether you need a fixed, single-piece solution, or a pluggable, two-piece combination, Eurostyle terminal blocks from Molex provide a quality connection every time.

Beau Eurostyle terminal blocks are available from 3.50mm (.138") pitch to 15.00mm (.591") pitch, with current ratings ranging from 8.0 to 30.0A per circuit. The range of styles, configurations, pitches and ratings makes it easy for you to find the right connector for your design.

### Features and Benefits

- Rising cage clamp termination provides a secure connection without strand damage or intermittence
- Various imprinting styles available making wiring and repair faster and easier in the field
- Optional mounting ends ensure plugs maintain connection with PCB headers

- Some PCB headers available as surface mount compatible
- Industry standard interface for compatibility with existing board layouts
- Made from self-extinguishing nylon material, UL 94 V-0 flammability rating

### Reference Information

UL File No.: E48521

## Plugs



No. of Circuits	Pitch	Series	Component	Orientation	Current	Voltage	Wire Range (AWG)	Lead-free
2-20	3.50mm (.138")	39500	Plug	Horizontal	8.0	300V	16-30	Yes
		39503		Vertical				
		39504	Plug with retention screws	Horizontal				
		39507		Vertical				
2-20	3.81mm (.150")	39510	Plug	Horizontal	8.0	300V	16-30	
		39513		Vertical				
		39514	Plug with retention screws	Horizontal				
		39517		Vertical				
2-24	5.00mm (.197")	39520	Plug	Horizontal	18.0	300V	12-30	
		39523		Vertical				
		39524	Plug with retention screws	Horizontal				
		39527		Vertical				
2-24	5.08mm (.200")	39530	Plug	Horizontal	18.0	300V	12-30	
		39533		Vertical				
		39534	Plug with retention screws	Horizontal				
		39537		Vertical				
2-12	7.50mm (.295")	39371	Plug	Horizontal	15.0	300V	12-30	
		39374		Vertical				

## Headers

### Reference Information

UL File No.: E48521



### PCB Headers

No. of Circuits	Pitch	Series	Component	Orientation	Current	Voltage	Wire Range (AWG)	Lead-free
2-20	3.50mm (.138")	39502	PCB Header	Horizontal	8.0	300V	N/A	Yes
		39501		Vertical				
		39506	PCB Header with retention inserts	Horizontal				
		39505		Vertical				
2-20	3.81mm (.150")	39512	PCB Header	Horizontal	8.0	300V	N/A	
		39511		Vertical				
		39516	PCB Header with retention inserts	Horizontal				
		39515		Vertical				
2-24	5.00mm (.197")	39522	PCB Header	Horizontal	18.0	300V	N/A	
		39521		Vertical				
		39526	PCB Header with retention inserts	Horizontal				
		39525		Vertical				
4-48		39528	PCB Header, dual level	Horizontal and Vertical				
2-24	5.08mm (.200")	39532	PCB Header	Horizontal	18.0	300V	N/A	
		39531		Vertical				
		39536	PCB Header with retention inserts	Horizontal				
		39535		Vertical				
4-48		39538	PCB Header, dual level	Horizontal and Vertical				
2-12	7.50mm (.295")	39373	PCB Header	Horizontal	15.0	300V	N/A	
		39372		Vertical				

# Beau® Eurostyle™ PCB Terminal Blocks

Reference Information  
UL File No.: E48521

## Fixed Terminal Blocks



No. of Circuits	Pitch	Series	Orientation	Current	Voltage	Wire Range (AWG)	Lead-free
2-25	3.50mm (.138")	39357	Vertical	12.0	300V	16-18	Yes
2-24	5.00mm (.197")	39543	Vertical, Horizontal, 45° angle	10.0		14-22	
		39890	Vertical, 35° angle	13.5		16-30	
	5.08mm (.200")	39544	Vertical, Horizontal, 45° angle	15.0		12-30	
		39880	Vertical, 35° angle	13.5		16-30	
2-3*	6.35mm (.250")	39380	Vertical	30		10-30	
	9.53mm (.375")	39390					

\*Note: 39380 and 39390 are modular. Two and three circuit parts can be used to assemble larger circuit sizes.

# Eurostyle™ PCB Terminal Blocks Multi-level (Fixed) Blocks

### Features and Benefits

- Modular design allows larger circuit sizes to be created by stacking smaller circuit parts together, which reduces inventory
- Rising cage clamp wire termination provides secure, reliable contact
- Two and three level parts have staggered rows to make wiring easier

Reference Information  
UL File No.: E48521



Industrial Products

S

### Multi-Level

Circuits	Pitch	Series	Profile	Levels	Current	Voltage	Wire Range (AWG)	Lead-free
4-48	5.00 (.197)	39890	Low	2	13.5A	300V	16-30	Yes
			Medium		17.5A		12-30	
	5.08 (.200)	39880	Low		13.5A		16-30	
			Medium		17.5A		12-30	
6-72	5.00 (.197)	39890	Low	3	13.5A		16-30	
			Medium		17.5A		12-30	
	5.08 (.200)	39880	Low		13.5A		16-30	
			Medium		17.5A		12-30	
			High		24.0A	12-30		
			High		24.0A	12-30		

# Beau® Eurostyle™ PCB Terminal Blocks

## High-Power Terminal Blocks



### Features and Benefits

- Rising cage clamp wire termination provides secure, reliable contact
- Multiple PCB terminals distribute power more evenly, reducing "hot spots"
- Combination slotted/posi drive screw heads improve transmission of torque for superior wire retention
- Extended wire funnel entry surrounds the wire insulator, eliminating exposed wire strands and possible shorting

### Reference Information

UL File No.: E48521

### Fixed High-Power

Circuits	Pitch	Series	Orientation	Current	Voltage	Wire Range (AWG)	Lead-free
2-14	10.16 (.400)	39910	Vertical	60.0/40.0A	600V	6-18	Yes
2-12	15.00 (.591)	39920		85.0/115.0A		3-14/1-8	
3-16	8.00 (.315)	39950		20.0A		12-22	
3-12	8.00 (.315)	39960		30.0A		10-22	
2-12	10.16 (.400)	39970		60.0/40.0A	300V	6-18	

### Pluggable High-Power

#### Plug

Circuits	Pitch	Series	Component	Orientation	Current	Voltage	Wire Range (AWG)	Lead-free
2-10	12.00 (.472)	39421	Plug	Horizontal	85.0A	600V	3-14	Yes
2-8		39422	Plug with retention screws					

#### Header

Circuits	Pitch	Series	Component	Orientation	Current	Voltage	Lead-free
2-10	12.00 (.472)	39425	PCB Header	Horizontal	85.0A	600V	Yes
2-8		39426	PCB Header with retention inserts				

[www.molex.com/product/highpower\\_tb.html](http://www.molex.com/product/highpower_tb.html)

# Pluggable Beau® Euromate™



### Features and Benefits

- Wiring terminals are staggered and offset vertically to facilitate easier wiring access
- Rear barrier prevents over-insertion of wire into device
- Accepts 6.35mm (.250") ring and spade wiring terminals

### Reference Information

UL File No.: E48521

Circuits	Pitch	Series	Orientation	Current	Voltage	Wire Range (AWG)	Lead-free
3-21	3.81 (.138)	39930	Vertical	12.0A	300V	14-22	Yes
3-24	5.08 (.200)	39940		15.0A		12-22	

\* Mates with most 3.81 and 5.08mm (.138 and .200") pitch headers.

## Positive Locking Plugs and Headers



### Features and Benefits

- Polarization feature eliminates the potential for mismatching
- Low-profile Eurostyle plug
- Positive latching system resists vibration and wire loads
- Surface Mount Compatible headers can withstand reflow soldering temperatures, eliminating the need for a secondary wave soldering operation

### Reference Information

UL File No.: E48521

### Plugs

Circuits	Pitch	Series	Orientation	Current	Voltage	Wire Range (AWG)	Lead-free
2-24	5.08 (.200)	39980	Vertical	10.0A	300V	12-24	Yes
2-18	5.00 (.197)	39990				12-26	

### Headers

Circuits	Pitch	Series	Orientation	Current	Voltage	Lead-free
2-24	5.08 (.200)	39980	Vertical	10.0A	300V	Yes
2-18	5.00 (.197)	39990				

[www.molex.com/product/poslatch\\_tb.html](http://www.molex.com/product/poslatch_tb.html)

## Eurostyle™ Terminal Blocks

## Eurostyle Two-Screw Terminal Strips

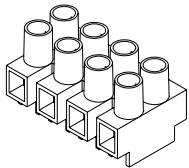

### Features and Benefits

- Modular design allows larger blocks to be easily cut into smaller circuit sizes
- Contacts and screws are recessed in the housing to help prevent short circuits and provide added finger safety
- Wire protectors prevent stranded wire damage during connection

Circuits	Pitch	Series	Current	Voltage	Wire Range (AWG)	Description	Lead-free
2-12	8.00 (.315)	39100-08XX	20.0A	600V	12-22	Standard profile, with standoffs	Yes
	10.00 (.394)	39100-10XX	30.0A		10-18		
	12.00 (.472)	39100-12XX	40.0A		8-20		
	15.00 (.591)	39100-15XX	63.0A		6-14		

Low profile (300V) versions of 8.00, 10.00 and 12.00mm (.315, .394 and .472") terminal blocks available  
Jumpers available in 2 or 3 circuit lengths



# Beau® Barrier Strips

**Beau terminal blocks provide a robust connection between wires and the PCB.**

Beau terminal blocks are a great connector for their durability and versatility. Barrier strips can handle currents of up to 45.0A per circuit and all are rated for 300 or 600V. With the variety of terminal styles, screws and other options available on barrier strips, these parts can be customized in many ways.

Special additions to barrier strips such as topside hardware, marker strips and hinged covers ensure that you get the best possible connector designed specifically for your application.

## Features

- Optional topside hardware allows for further customization to fit your design requirements
- Robust and durable screw terminals are ultrasonically welded into the thermoplastic insulator, reducing the risk for terminal twisting and solder joint failure
- Tri-barrier construction of some barrier strips provides a back wall to prevent over insertion and shorting
- No special tools required to terminate wires, only a No. 2 screwdriver required
- Broad range of screw and terminal options improves interconnect performance
- Various imprinting styles aid in labeling circuits for wiring, testing and repair in the field
- RoHS and ELV compliant

## 8.26mm (.325") Pitch Barrier Terminal Strips

### 38700 PC Terminal

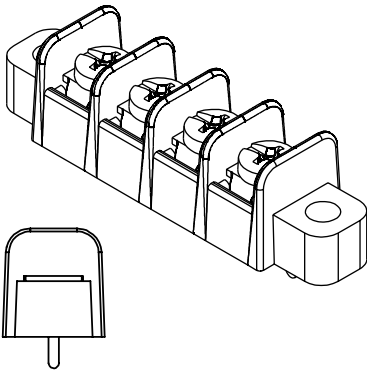

## Reference Information

Packaging: Tray  
UL File No.: E48521  
Flammability: UL 94V-0  
Designed In: Inches

## Electrical

Voltage: 300V  
Current: 15.0A  
Dielectric Withstanding Voltage: 1600V AC  
Insulation Resistance: 1000 Megohms min.

## Mechanical

Recommended Tightening Torque: 1.36Nm (12 in.-lb)

## Physical

Housing: PBT, black  
Terminal: Brass  
Screw: Steel, #6-32, Phillips/Slot combo head  
Plating: Terminal Area—Tin  
Screw—Zinc with clear chromate  
Wire Range: 14 to 22 AWG

Circuits	Order No.		Lead-free
	With Mounting Ends	Without Mounting Ends	
2	<a href="#">38700-6102</a>	<a href="#">38700-6302</a>	Yes
3	<a href="#">38700-6103</a>	<a href="#">38700-6303</a>	
4	<a href="#">38700-6104</a>	<a href="#">38700-6304</a>	
5	<a href="#">38700-6105</a>	<a href="#">38700-6305</a>	
6	<a href="#">38700-6106</a>	<a href="#">38700-6306</a>	
7	<a href="#">38700-6107</a>	<a href="#">38700-6307</a>	
8	<a href="#">38700-6108</a>	<a href="#">38700-6308</a>	
9	<a href="#">38700-6109</a>	<a href="#">38700-6309</a>	
10	<a href="#">38700-6110</a>	<a href="#">38700-6310</a>	
11	<a href="#">38700-6111</a>	<a href="#">38700-6311</a>	
12	<a href="#">38700-6112</a>	<a href="#">38700-6312</a>	
13	<a href="#">38700-6113</a>	<a href="#">38700-6313</a>	
14	<a href="#">38700-6114</a>	<a href="#">38700-6314</a>	

Circuits	Order No.		Lead-free
	With Mounting Ends	Without Mounting Ends	
15	<a href="#">38700-6115</a>	<a href="#">38700-6315</a>	Yes
16	<a href="#">38700-6116</a>	<a href="#">38700-6316</a>	
17	<a href="#">38700-6117</a>	<a href="#">38700-6317</a>	
18	<a href="#">38700-6118</a>	<a href="#">38700-6318</a>	
19	<a href="#">38700-6119</a>	<a href="#">38700-6319</a>	
20	<a href="#">38700-6120</a>	<a href="#">38700-6320</a>	
21	<a href="#">38700-6121</a>	<a href="#">38700-6321</a>	
22	<a href="#">38700-6122</a>	<a href="#">38700-6322</a>	
23	<a href="#">38700-6123</a>	<a href="#">38700-6323</a>	
24	<a href="#">38700-6124</a>	<a href="#">38700-6324</a>	
25	<a href="#">38700-6125</a>	<a href="#">38700-6325</a>	
26	<a href="#">38700-6126</a>	<a href="#">38700-6326</a>	

# 8.26mm (.325") Pitch Single Row Tri-Barrier Terminal Strips

**38704**  
PC Terminal

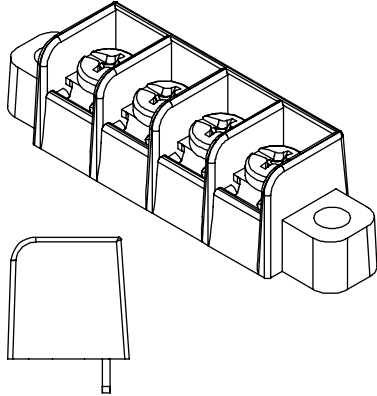

**Reference Information**

Packaging: Tray  
UL File No.: E48521  
Flammability: UL 94V-0  
Designed In: Inches

**Electrical**

Voltage: 300V  
Current: 15.0A  
Dielectric Withstanding Voltage: 1600V AC  
Insulation Resistance: 1000 Megohms min.

**Mechanical**

Recommended Tightening Torque: 1.36Nm (12 in.-lb)

**Physical**

Housing: PBT, black  
Terminal: Brass  
Screw: Steel, #6-32, Phillips/Slot combo head  
Plating: Terminal Area—Tin  
Screw—Zinc with clear chromate  
Wire Range: 14 to 22 AWG

Circuits	Order No.		Lead-free
	With Mounting Ends	Without Mounting Ends	
2	<a href="#">38704-4002</a>	<a href="#">38704-4102</a>	Yes
3	<a href="#">38704-4003</a>	<a href="#">38704-4102</a>	
4	<a href="#">38704-4004</a>	<a href="#">38704-4102</a>	
5	<a href="#">38704-4005</a>	<a href="#">38704-4102</a>	
6	<a href="#">38704-4006</a>	<a href="#">38704-4102</a>	
7	<a href="#">38704-4007</a>	<a href="#">38704-4102</a>	

Circuits	Order No.		Lead-free
	With Mounting Ends	Without Mounting Ends	
8	<a href="#">38704-4008</a>	<a href="#">38704-4108</a>	Yes
9	<a href="#">38704-4009</a>	<a href="#">38704-4109</a>	
10	<a href="#">38704-4010</a>	<a href="#">38704-4110</a>	
11	<a href="#">38704-4011</a>	<a href="#">38704-4111</a>	
12	<a href="#">38704-4012</a>	<a href="#">38704-4112</a>	

# 8.26mm (.325") Pitch Dual Level Barrier Terminal Strips

**38706**  
Dual Level, PC Terminal

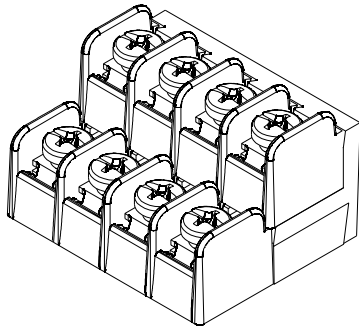

**Reference Information**

Packaging: Tray  
UL File No.: E48521  
Flammability: UL 94V-0

**Electrical**

Voltage: 300V  
Current: 15.0A  
Insulation Resistance: 5000 Megohms min.  
Dielectric Withstanding Voltage: 1600V AC

**Mechanical**

Recommended Tightening Torque: 1.36Nm (12 in.-lb.)  
Wire Range: 14 to 22 AWG

**Physical**

Housing: Polysulfone, black  
Terminal: Brass  
Screw: Steel, #6-32, Phillips/Slot combo head  
Plating: Terminal—Tin  
Screw—Zinc with clear chromate

Circuits	Order No.	Lead-free
4	<a href="#">38706-0004</a>	Yes
6	<a href="#">38706-0006</a>	
8	<a href="#">38706-0008</a>	
10	<a href="#">38706-0010</a>	
12	<a href="#">38706-0012</a>	
14	<a href="#">38706-0014</a>	

Circuits	Order No.	Lead-free
16	<a href="#">38706-0016</a>	Yes
18	<a href="#">38706-0018</a>	
20	<a href="#">38706-0020</a>	
22	<a href="#">38706-0022</a>	
24	<a href="#">38706-0024</a>	

# 9.53mm (.375") Pitch Single Row Barrier Terminal Strips

## 38720 Panel Mount

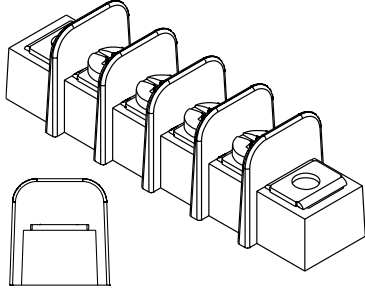

### Reference Information

Packaging: Tray  
UL File No.: E48521  
Flammability: UL 94V-0  
Designed In: Inches

### Electrical

Voltage: 300V  
Current: 15.0A  
Dielectric Withstanding Voltage: 1600V AC  
Insulation Resistance: 5000 Megohms min.

### Mechanical

Recommended Tightening Torque: 1.36Nm (12 in.-lb)

### Physical

Housing: PBT, black  
Terminal: Brass  
Screw: Steel, #6-32, Phillips/Slot combo head  
Plating: Terminal Area—Tin  
Screw—Zinc with clear chromate  
Wire Range: 14 to 22 AWG

Circuits	Order No.		Lead-free
	With Mounting Ends	Without Mounting Ends	
2	<a href="#">38720-0202</a>	<a href="#">38720-0302</a>	Yes
3	<a href="#">38720-0203</a>	<a href="#">38720-0303</a>	
4	<a href="#">38720-0204</a>	<a href="#">38720-0304</a>	
5	<a href="#">38720-0205</a>	<a href="#">38720-0305</a>	
6	<a href="#">38720-0206</a>	<a href="#">38720-0306</a>	
7	<a href="#">38720-0207</a>	<a href="#">38720-0307</a>	
8	<a href="#">38720-0208</a>	<a href="#">38720-0308</a>	
9	<a href="#">38720-0209</a>	<a href="#">38720-0309</a>	
10	<a href="#">38720-0210</a>	<a href="#">38720-0310</a>	
11	<a href="#">38720-0211</a>	<a href="#">38720-0311</a>	
12	<a href="#">38720-0212</a>	<a href="#">38720-0312</a>	
13	<a href="#">38720-0213</a>	<a href="#">38720-0313</a>	
14	<a href="#">38720-0214</a>	<a href="#">38720-0314</a>	

Circuits	Order No.		Lead-free
	With Mounting Ends	Without Mounting Ends	
15	<a href="#">38720-0215</a>	<a href="#">38720-0315</a>	Yes
16	<a href="#">38720-0216</a>	<a href="#">38720-0316</a>	
17	<a href="#">38720-0217</a>	<a href="#">38720-0317</a>	
18	<a href="#">38720-0218</a>	<a href="#">38720-0318</a>	
19	<a href="#">38720-0219</a>	<a href="#">38720-0319</a>	
20	<a href="#">38720-0220</a>	<a href="#">38720-0320</a>	
21	<a href="#">38720-0221</a>	<a href="#">38720-0321</a>	
22	<a href="#">38720-0222</a>	<a href="#">38720-0322</a>	
23	<a href="#">38720-0223</a>	<a href="#">38720-0323</a>	
24	<a href="#">38720-0224</a>	<a href="#">38720-0324</a>	
25	<a href="#">38720-0225</a>	<a href="#">38720-0325</a>	
26	<a href="#">38720-0226</a>	<a href="#">38720-0326</a>	

# 9.53mm (.375") Pitch Single Row Barrier Terminal Strips

## 38720 PC Terminal

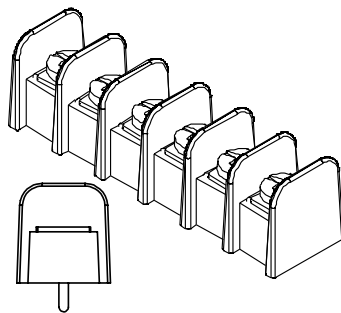

### Reference Information

Packaging: Tray  
UL File No.: E48521  
Flammability: UL 94V-0  
Designed In: Inches

### Electrical

Voltage: 300V  
Current: 15.0A  
Dielectric Withstanding Voltage: 1600V AC  
Insulation Resistance: 1000 Megohms min.

### Mechanical

Recommended Tightening Torque: 1.36Nm (12 in.-lb)

### Physical

Housing: PBT, black  
Terminal: Brass  
Screw: Steel, #6-32, Philips/Slot combo head  
Plating: Terminal Area—Tin  
Screw—Zinc with clear chromate  
Wire Range: 14 to 22 AWG

Circuits	Order No.		Lead-free
	With Mounting Ends	Without Mounting Ends	
2	<a href="#">38720-6202</a>	<a href="#">38720-6302</a>	Yes
3	<a href="#">38720-6203</a>	<a href="#">38720-6303</a>	
4	<a href="#">38720-6204</a>	<a href="#">38720-6304</a>	
5	<a href="#">38720-6205</a>	<a href="#">38720-6305</a>	
6	<a href="#">38720-6206</a>	<a href="#">38720-6306</a>	
7	<a href="#">38720-6207</a>	<a href="#">38720-6307</a>	
8	<a href="#">38720-6208</a>	<a href="#">38720-6308</a>	
9	<a href="#">38720-6209</a>	<a href="#">38720-6309</a>	
10	<a href="#">38720-6210</a>	<a href="#">38720-6310</a>	
11	<a href="#">38720-6211</a>	<a href="#">38720-6311</a>	
12	<a href="#">38720-6212</a>	<a href="#">38720-6312</a>	
13	<a href="#">38720-6213</a>	<a href="#">38720-6313</a>	
14	<a href="#">38720-6214</a>	<a href="#">38720-6314</a>	

Circuits	Order No.		Lead-free
	With Mounting Ends	Without Mounting Ends	
15	<a href="#">38720-6215</a>	<a href="#">38720-6315</a>	Yes
16	<a href="#">38720-6216</a>	<a href="#">38720-6316</a>	
17	<a href="#">38720-6217</a>	<a href="#">38720-6317</a>	
18	<a href="#">38720-6218</a>	<a href="#">38720-6318</a>	
19	<a href="#">38720-6219</a>	<a href="#">38720-6319</a>	
20	<a href="#">38720-6220</a>	<a href="#">38720-6320</a>	
21	<a href="#">38720-6221</a>	<a href="#">38720-6321</a>	
22	<a href="#">38720-6222</a>	<a href="#">38720-6322</a>	
23	<a href="#">38720-6223</a>	<a href="#">38720-6323</a>	
24	<a href="#">38720-6224</a>	<a href="#">38720-6324</a>	
25	<a href="#">38720-6225</a>	<a href="#">38720-6325</a>	
26	<a href="#">38720-6226</a>	<a href="#">38720-6326</a>	

# 9.53mm (.375") Pitch Double Row Barrier Terminal Strips

**38760/38770**  
Panel Mount

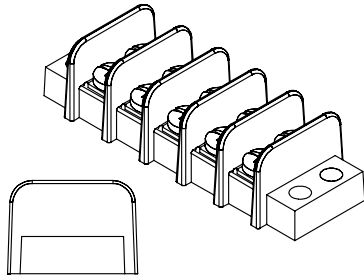

### Reference Information

Packaging: Tray  
UL File No.: E48521  
Flammability: UL 94V-0  
Designed In: Inches

### Electrical

Voltage: 300V  
Current: 15.0A  
Dielectric Withstanding Voltage: 1600V AC  
Insulation Resistance: 1000 Megohms min.

### Mechanical

Recommended Tightening Torque: 1.26Nm (12 in.-lb)

### Physical

Housing: PBT, black  
Terminal: Brass  
Screw: Steel, #6-32, Phillips/Slot combo head  
Plating: Terminal Area—Tin  
Screw—Zinc with clear chromate  
Wire Range: 14 to 22 AWG

Circuits	Order No.		Lead-free
	Low Profile	Standard	
2	<a href="#">38770-0102</a>	<a href="#">38760-0102</a>	Yes
3	<a href="#">38770-0103</a>	<a href="#">38760-0103</a>	
4	<a href="#">38770-0104</a>	<a href="#">38760-0104</a>	
5	<a href="#">38770-0105</a>	<a href="#">38760-0105</a>	
6	<a href="#">38770-0106</a>	<a href="#">38760-0106</a>	
7	<a href="#">38770-0107</a>	<a href="#">38760-0107</a>	
8	<a href="#">38770-0108</a>	<a href="#">38760-0108</a>	
9	<a href="#">38770-0109</a>	<a href="#">38760-0109</a>	
10	<a href="#">38770-0110</a>	<a href="#">38760-0110</a>	
11	<a href="#">38770-0111</a>	<a href="#">38760-0111</a>	
12	<a href="#">38770-0112</a>	<a href="#">38760-0112</a>	
13	<a href="#">38770-0113</a>	<a href="#">38760-0113</a>	
14	<a href="#">38770-0114</a>	<a href="#">38760-0114</a>	
15	<a href="#">38770-0115</a>	<a href="#">38760-0115</a>	

Circuits	Order No.		Lead-free
	Low Profile	Standard	
16	<a href="#">38770-0116</a>	<a href="#">38760-0116</a>	Yes
17	<a href="#">38770-0117</a>	<a href="#">38760-0117</a>	
18	<a href="#">38770-0118</a>	<a href="#">38760-0118</a>	
19	<a href="#">38770-0119</a>	<a href="#">38760-0119</a>	
20	<a href="#">38770-0120</a>	<a href="#">38760-0120</a>	
21	<a href="#">38770-0121</a>	<a href="#">38760-0121</a>	
22	<a href="#">38770-0122</a>	<a href="#">38760-0122</a>	
23	<a href="#">38770-0123</a>	<a href="#">38760-0123</a>	
24	<a href="#">38770-0124</a>	<a href="#">38760-0124</a>	
25	<a href="#">38770-0125</a>	<a href="#">38760-0125</a>	
26	<a href="#">38770-0126</a>	<a href="#">38760-0126</a>	
27	<a href="#">38770-0127</a>	<a href="#">38760-0127</a>	
28	<a href="#">38770-0128</a>	<a href="#">38760-0128</a>	
29	<a href="#">38770-0129</a>	<a href="#">38760-0129</a>	
30	<a href="#">38770-0130</a>	<a href="#">38760-0130</a>	

# 11.1mm (.438") Pitch Double Row Barrier Terminal Strips

**38780**  
Panel Mount

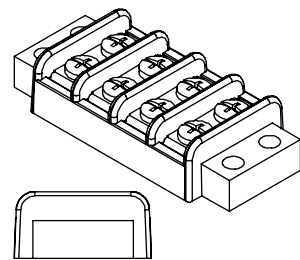

### Reference Information

Packaging: Tray  
UL File No.: E48521  
Flammability: UL 94V-0  
Designed In: Inches

### Electrical

Voltage: 300V  
Current: 15.0A  
Dielectric Withstanding Voltage: 1600V AC  
Insulation Resistance: 1000 Megohms min.

### Mechanical

Recommended Tightening Torque: 1.36Nm (12 in.-lb)

### Physical

Housing: PBT, black  
Terminal: Brass  
Screw: Steel, #6-32, Phillips/Slot combo head  
Plating: Terminal Area—Nickel  
Screw—Zinc with clear chromate  
Wire Range: 14 to 22 AWG

Circuits	Order No.	Lead-free
2	<a href="#">38780-0102</a>	Yes
3	<a href="#">38780-0103</a>	
4	<a href="#">38780-0104</a>	
5	<a href="#">38780-0105</a>	
6	<a href="#">38780-0106</a>	
7	<a href="#">38780-0107</a>	
8	<a href="#">38780-0108</a>	
9	<a href="#">38780-0109</a>	
10	<a href="#">38780-0110</a>	
11	<a href="#">38780-0111</a>	

Circuits	Order No.	Lead-free
12	<a href="#">38780-0112</a>	Yes
13	<a href="#">38780-0113</a>	
14	<a href="#">38780-0114</a>	
15	<a href="#">38780-0115</a>	
16	<a href="#">38780-0116</a>	
17	<a href="#">38780-0117</a>	
18	<a href="#">38780-0118</a>	
19	<a href="#">38780-0119</a>	
20	<a href="#">38780-0120</a>	
21	<a href="#">38780-0121</a>	

Circuits	Order No.	Lead-free
22	<a href="#">38780-0122</a>	Yes
23	<a href="#">38780-0123</a>	
24	<a href="#">38780-0124</a>	
25	<a href="#">38780-0125</a>	
26	<a href="#">38780-0126</a>	
27	<a href="#">38780-0127</a>	
28	<a href="#">38780-0128</a>	
29	<a href="#">38780-0129</a>	
30	<a href="#">38780-0130</a>	

# Beau™ Power Connectors Panel Mount Plugs and Sockets

**38330**

**Angle Bracket,  
Angle Bracket Tapped,  
Without Angle Bracket**



Angle Bracket shown

**Features and Benefits**

- Robust blade contacts resist damage from improper mating
- Large surface area of dual wipe female contact produces maximum current capacity
- All circuits are rated for full current load

**Reference Information**

Packaging: Tray  
UL File No.: E34763  
CSA File No.: 22156  
Designed In: Inches

**Electrical**

Voltage: 250V  
Current: 10.0A

**Mechanical**

Durability: 500 cycles

**Physical**

Housing: Phenolic  
Plug Contact: Brass  
Socket Contact: Phosphor Bronze  
Plating: Plug Contact—Tin  
Socket Contact—Tin

**Plugs**

Circuits	Order No.			Lead-free
	Angle Bracket	Angle Bracket Tapped	Without Angle Bracket	
2	<a href="#">38330-0102</a>	<a href="#">38330-1502</a>	<a href="#">38330-2202</a>	Yes
3	<a href="#">38330-0103</a>	<a href="#">38330-1503</a>	<a href="#">38330-2203</a>	
4	<a href="#">38330-0104</a>	<a href="#">38330-1504</a>	<a href="#">38330-2204</a>	
6	<a href="#">38330-0106</a>	<a href="#">38330-1506</a>	<a href="#">38330-2206</a>	
8	<a href="#">38330-0108</a>	<a href="#">38330-1508</a>	<a href="#">38330-2208</a>	
10	<a href="#">38330-0110</a>	<a href="#">38330-1510</a>	<a href="#">38330-2210</a>	
12	<a href="#">38330-0112</a>	<a href="#">38330-1512</a>	<a href="#">38330-2212</a>	
15	<a href="#">38330-0115</a>	<a href="#">38330-1515</a>	<a href="#">38330-2215</a>	
18	<a href="#">38330-0118</a>	<a href="#">38330-1518</a>	<a href="#">38330-2218</a>	
21	<a href="#">38330-0121</a>	<a href="#">38330-1521</a>	<a href="#">38330-2221</a>	
24	<a href="#">38330-0124</a>	<a href="#">38330-1524</a>	<a href="#">38330-2224</a>	
27	<a href="#">38330-0127</a>	<a href="#">38330-1527</a>	<a href="#">38330-2227</a>	
30	<a href="#">38330-0130</a>	<a href="#">38330-1530</a>	<a href="#">38330-2230</a>	
33	<a href="#">38330-0133</a>	<a href="#">38330-1533</a>	<a href="#">38330-2233</a>	

**Sockets**

Circuits	Order No.			Lead-free
	Angle Bracket	Angle Bracket Tapped	Without Angle Bracket	
2	<a href="#">38330-0502</a>	<a href="#">38330-1902</a>	<a href="#">38330-2602</a>	Yes
3	<a href="#">38330-0503</a>	<a href="#">38330-1903</a>	<a href="#">38330-2603</a>	
4	<a href="#">38330-0504</a>	<a href="#">38330-1904</a>	<a href="#">38330-2604</a>	
6	<a href="#">38330-0506</a>	<a href="#">38330-1906</a>	<a href="#">38330-2606</a>	
8	<a href="#">38330-0508</a>	<a href="#">38330-1908</a>	<a href="#">38330-2608</a>	
10	<a href="#">38330-0510</a>	<a href="#">38330-1910</a>	<a href="#">38330-2610</a>	
12	<a href="#">38330-0512</a>	<a href="#">38330-1912</a>	<a href="#">38330-2612</a>	
15	<a href="#">38330-0515</a>	<a href="#">38330-1915</a>	<a href="#">38330-2615</a>	
18	<a href="#">38330-0518</a>	<a href="#">38330-1918</a>	<a href="#">38330-2618</a>	
21	<a href="#">38330-0521</a>	<a href="#">38330-1921</a>	<a href="#">38330-2621</a>	
24	<a href="#">38330-0524</a>	<a href="#">38330-1924</a>	<a href="#">38330-2624</a>	
27	<a href="#">38330-0527</a>	<a href="#">38330-1927</a>	<a href="#">38330-2627</a>	
30	<a href="#">38330-0530</a>	<a href="#">38330-1930</a>	<a href="#">38330-2630</a>	
33	<a href="#">38330-0533</a>	<a href="#">38330-1933</a>	<a href="#">38330-2633</a>	

Note: Solder Eye is the standard contact tail for plugs and sockets. Contact Molex for additional contact options and order numbers.

# Beau™ Power Connectors Cable Mount Plugs and Sockets

**38331**

**Cable Clamp Top**



Cable Clamp Top shown

**Features and Benefits**

- Latch and keeper hardware ensure that plug and socket remain mated even in high vibration applications
- Robust blade contacts resist damage from improper mating
- Large surface area of dual wipe female contact produces maximum current capacity
- All circuits are rated for full current load

**Reference Information**

Packaging: Tray  
UL File No.: E34763  
CSA File No.: 22156  
Designed In: Inches

**Electrical**

Voltage: 250V  
Current: 10.0A

**Mechanical**

Durability: 500 cycles

**Physical**

Housing: Phenolic  
Plug Contact: Brass  
Socket Contact: Phosphor Bronze  
Plating: Plug Contact—Tin  
Socket Contact—Tin

**Plugs**

Circuits	Order No.	Lead-free
	Cable Clamp Top	
2	<a href="#">38331-5602</a>	Yes
3	<a href="#">38331-5603</a>	
4	<a href="#">38331-5604</a>	
6	<a href="#">38331-5606</a>	
8	<a href="#">38331-5608</a>	
10	<a href="#">38331-5610</a>	
12	<a href="#">38331-5612</a>	

Circuits	Order No.	Lead-free
	Cable Clamp Top	
15	<a href="#">38331-5615</a>	Yes
18	<a href="#">38331-5618</a>	
21	<a href="#">38331-5621</a>	
24	<a href="#">38331-5624</a>	
27	<a href="#">38331-5627</a>	
30	<a href="#">38331-5630</a>	
33	<a href="#">38331-5633</a>	

**Sockets**

Circuits	Order No.	Lead-free
	Cable Clamp Top	
2	<a href="#">38331-8002</a>	Yes
3	<a href="#">38331-8003</a>	
4	<a href="#">38331-8004</a>	
6	<a href="#">38331-8006</a>	
8	<a href="#">38331-8008</a>	
10	<a href="#">38331-8010</a>	
12	<a href="#">38331-8012</a>	

Circuits	Order No.	Lead-free
	Cable Clamp Top	
15	<a href="#">38331-8015</a>	Yes
18	<a href="#">38331-8018</a>	
21	<a href="#">38331-8021</a>	
24	<a href="#">38331-8024</a>	
27	<a href="#">38331-8027</a>	
30	<a href="#">38331-8030</a>	
33	<a href="#">38331-8033</a>	

Note: Solder Eye is the standard contact tail for plugs and sockets. Contact Molex for additional contact options and order numbers.

# Beau™ Power Connectors Panel Mount Plugs and Sockets

## 38540 Angle Bracket



Angle Bracket shown

### Features and Benefits

- Robust blade contacts resist damage from improper mating
- Large surface area of dual wipe female contact produces maximum current capacity
- All circuits are rated for full current load

### Reference Information

Packaging: Tray  
UL File No.: E34763  
CSA File No.: 22156  
Designed In: Inches

### Electrical

Voltage: 250V  
Current: 15.0A

### Mechanical

Durability: 500 cycles

### Physical

Housing: Phenolic  
Plug Contact: Brass  
Socket Contact: Phosphor Bronze  
Plating: Plug Contact—Tin  
Socket Contact—Tin

### Plugs

Circuits	Order No.	Lead-free
	Angle Bracket	
4	<a href="#">38540-0104</a>	Yes
5	<a href="#">38540-0105</a>	
6	<a href="#">38540-0106</a>	
7	<a href="#">38540-0107</a>	
8	<a href="#">38540-0108</a>	
9	<a href="#">38540-0109</a>	
10	<a href="#">38540-0110</a>	
11	<a href="#">38540-0111</a>	
12	<a href="#">38540-0112</a>	
13	<a href="#">38540-0113</a>	
14	<a href="#">38540-0114</a>	
15	<a href="#">38540-0115</a>	
16	<a href="#">38540-0116</a>	

Note: Solder Hook is the standard contact tail for plugs. Contact Molex for additional contact options and order numbers.

### Sockets

Circuits	Order No.	Lead-free
	Angle Bracket	
4	<a href="#">38540-0604</a>	Yes
5	<a href="#">38540-0605</a>	
6	<a href="#">38540-0606</a>	
7	<a href="#">38540-0607</a>	
8	<a href="#">38540-0608</a>	
9	<a href="#">38540-0609</a>	
10	<a href="#">38540-0610</a>	
11	<a href="#">38540-0611</a>	
12	<a href="#">38540-0612</a>	
13	<a href="#">38540-0613</a>	
14	<a href="#">38540-0614</a>	
15	<a href="#">38540-0615</a>	
16	<a href="#">38540-0616</a>	

Note: Solder Eye is the standard contact tail for sockets. Contact Molex for additional contact options and order numbers.

# Beau™ Power Connectors Cable Mount Plugs and Sockets

## 38541 Cable Clamp Top



Cable Clamp Top shown

### Features and Benefits

- Strain relief cable clamps can be used with round or flat cable
- Robust blade contacts resist damage from improper mating
- Large surface area of dual wipe female contact produces maximum current capacity
- All circuits are rated for full current load

### Reference Information

Packaging: Tray  
UL File No.: E34763  
CSA File No.: 22156  
Designed In: Inches

### Electrical

Voltage: 250V  
Current: 15.0A

### Mechanical

Durability: 500 cycles

### Physical

Housing: Phenolic  
Plug Contact: Brass  
Socket Contact: Phosphor Bronze  
Plating: Plug Contact—Tin  
Socket Contact—Tin

### Plugs

Circuits	Order No.	Lead-free
	Cable Clamp Top	
4	<a href="#">38541-5404</a>	Yes
5	<a href="#">38541-5405</a>	
6	<a href="#">38541-5406</a>	
7	<a href="#">38541-5407</a>	
8	<a href="#">38541-5408</a>	
9	<a href="#">38541-5409</a>	
10	<a href="#">38541-5410</a>	
11	<a href="#">38541-5411</a>	
12	<a href="#">38541-5412</a>	
13	<a href="#">38541-5413</a>	
14	<a href="#">38541-5414</a>	
15	<a href="#">38541-5415</a>	
16	<a href="#">38541-5416</a>	

Note: Solder Hook is the standard contact tail for plugs. Contact Molex for additional contact options and order numbers.

### Sockets

Circuits	Order No.	Lead-free
	Cable Clamp Top	
4	<a href="#">38541-8404</a>	Yes
5	<a href="#">38541-8405</a>	
6	<a href="#">38541-8406</a>	
7	<a href="#">38541-8407</a>	
8	<a href="#">38541-8408</a>	
9	<a href="#">38541-8409</a>	
10	<a href="#">38541-8410</a>	
11	<a href="#">38541-8411</a>	
12	<a href="#">38541-8412</a>	
13	<a href="#">38541-8413</a>	
14	<a href="#">38541-8414</a>	
15	<a href="#">38541-8415</a>	
16	<a href="#">38541-8416</a>	

Note: Solder Eye is the standard contact tail for sockets. Contact Molex for additional contact options and order numbers.

# Wire Splice Terminal

35760

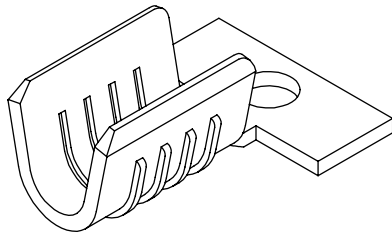

### Features and Benefits

- Uninsulated splices shaped like an open “U” accommodate stranded wire
- Non-insulation support

### Reference Information

Product Specification: PS-35760-003  
 Packaging: Reel  
 Designed In: Millimeters

### Electrical

Current: 25.0A  
 Contact Resistance: 3 milliohms max.

### Physical

Contact: Brass  
 Plating: Tin

Order No.	Material	Wire Range	Lead-free
<a href="#">35760-7100</a>	Brass	24-22	Yes
<a href="#">35760-7110</a>	Tin-plated Brass		
<a href="#">35760-7200</a>	Brass	22-18	
<a href="#">35760-7205</a>	Tin-plated Brass		
<a href="#">35760-7210</a>	Tin-plated Brass		
<a href="#">35760-7300</a>	Brass	16-14	
<a href="#">35760-7310</a>	Tin-plated Brass		
<a href="#">35760-7400</a>	Brass	14-10	
<a href="#">35760-7410</a>	Tin-plated Brass		

[www.molex.com/customer.html?seriesNumber=35760](http://www.molex.com/customer.html?seriesNumber=35760)

## Wire Management Products



### Heat Shrink Tubing

Molex offers a wide variety of heat shrink tubing including thin-wall, adhesive-lined dual-wall and heavy-wall polyolefin tubing as well as heat shrinkable PVC.

Thin (single) wall is high quality tubing with a wide variety of uses. It is made from flame retardant polyolefin, giving it excellent physical, chemical and electrical properties that meet industrial and military requirements for highly reliable, general-purpose tubing.

Dual-wall tubing is adhesive lined, and manufactured using fully flame retardant polyolefin tubing which offers superior strain relief as well as environmental sealing capabilities.

Heavy-wall tubing is UL rated for direct burial applications. This tubing is chemically cross linked during manufacturing which ensures that it will not split or rupture during installation, even if overheated.

### Closed-End Connectors

Molex nylon closed-end connectors feature two-piece construction. A translucent nylon insulator is adhered to the pure electrolytic, copper insert. Closed-end connectors are used in a wide variety of situations to “pigtail” two or more wires together, and can be used as a dead end splice or one power line and multiple lead offs.

### Multi-Lock Connectors

The Multi-Lock is an insulation displacement connector that allows quick tap-and-run connections. Using ordinary channel lock pliers, these color-coded connectors make quick, reliable, pre-insulated splices without having to strip, twist or solder.

The Multi-Lock connector consists of a polypropylene insulation with a tin-plated brass barb. Once the appropriate wires have been inserted, the barb is squeezed such that it “displaces” the insulation and makes contact with the wire, creating an electrical connection. The cover is then snapped into position, completely insulating the barb and wire.

### Wire Connectors

Molex Wire Connectors offer a cost effective way to produce safe and secure wire connections. The tough, thermoplastic shell provides UL-94V2 flame retardant protection while the fixed square-wire spring construction offers a secure connection that will not relax over time.

Standard Twist Locks feature a threaded funnel entry to easily guide wires into the connector.

Wing Locks offer deep gripping ribs and swept-back wings that permit a higher torque.

High Temp Wire Connectors are used in applications that require continued exposure to heat.

### Cable Ties

Molex offers a full line of standard cable ties as well as selected mounting and identification ties. Our cable ties are constructed from durable nylon 6/6 and offer a compact, one piece design. These industry standard products are designed to meet or exceed the MIL-S-23190E tensile strength requirements.

# Heavy-Duty Rectangular Industrial Connectors



## INTRODUCTION

Molex's line of HMC heavy-duty rectangular industrial connectors are designed for rugged applications such as robotics, machinery equipment, transportation, power generation and industrial controls. HMC provides an innovative new approach to traditional heavy-duty connections.

The HMC series includes some unique design features such as: rugged metal cable-side hood with easy-to-actuate "one-touch" lock; removable modular housing inserts that can be custom configured; and various circuit and amperage types to meet different power and signal needs.

## Features

### HMC™ Series

- Unique rounded-shape metal hood with single-action lock for space savings and easy handling
- Easy field removal of modules
- Cable-clamp solution that integrates sealed ring and holder into one-piece cover
- Single-module type enables housing inserts to be loaded into either side
- Multi-module type enables flexible module configurations that can be custom configured; and various circuit and amperage types to meet different power and signal needs

## HMC Series—Module Type



12 circuits, 35.0/10.0A, IP65



40 circuits, 10.0A, IP65



52 circuits, 10.0A, IP65



36 circuits, 12.0A, IP65



48/72 circuits, 20.0/12.0A, IP65



**HMC™**  
**12 circuits—35A/**  
**10 circuits - IP65**  
**10A/2 circuits**  
**Connection System**

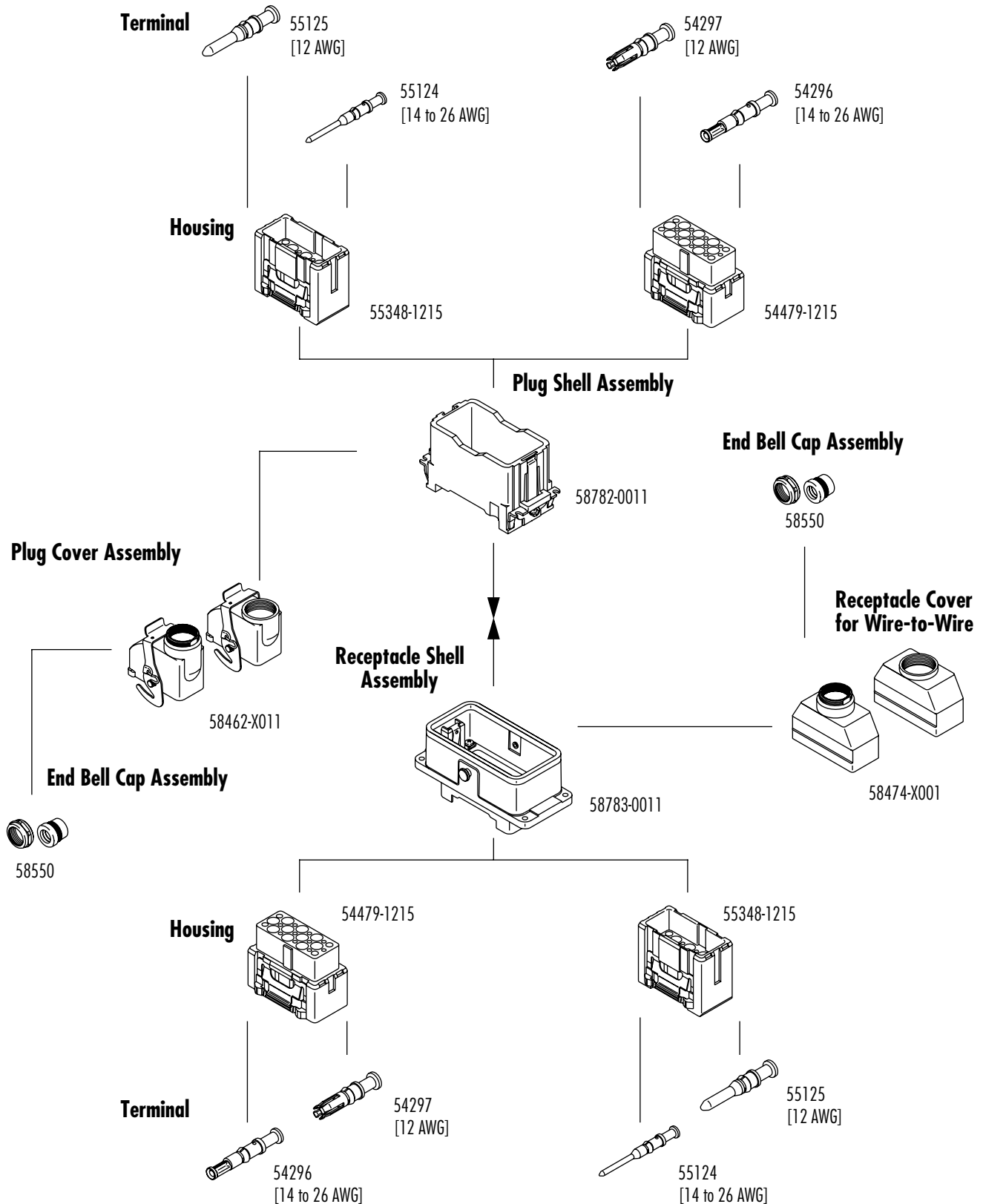

# HMC™ 10A/40 circuits—IP65 Connection System

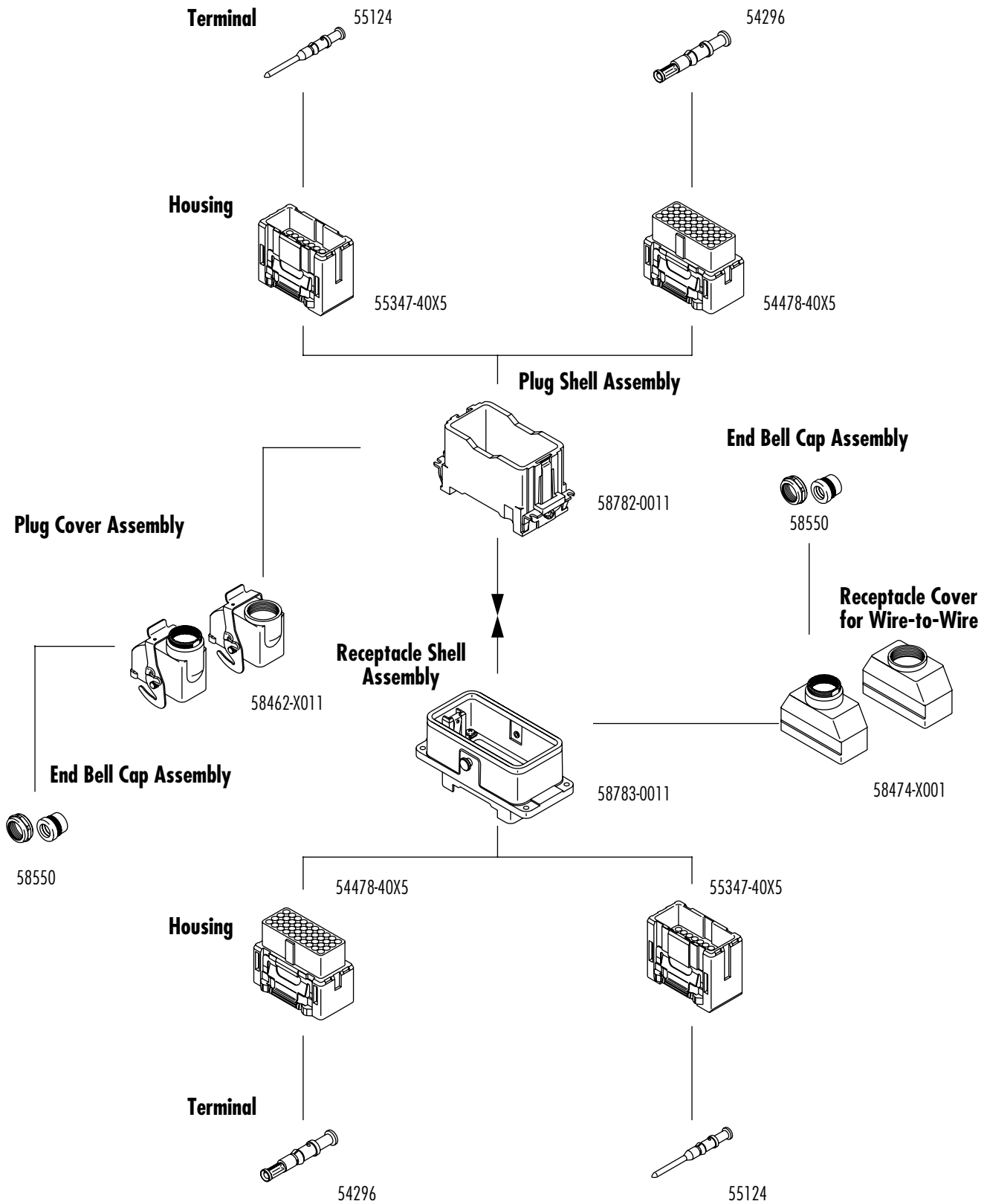

Industrial Products

S

**HMC™**  
**10A/52 circuits—IP65**  
**Connection System**

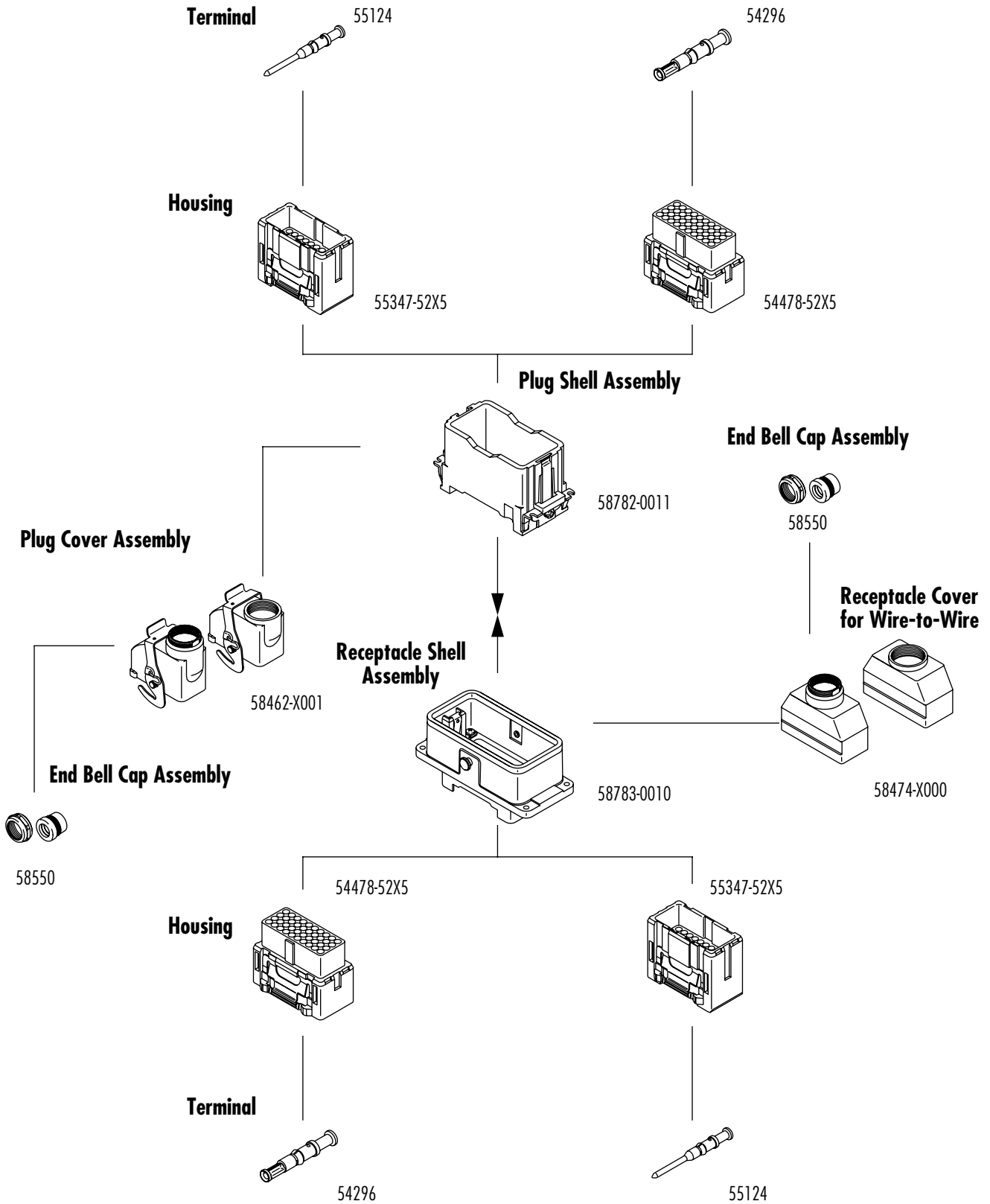

# HMC™ 12A/36 circuits—IP65 Connection System

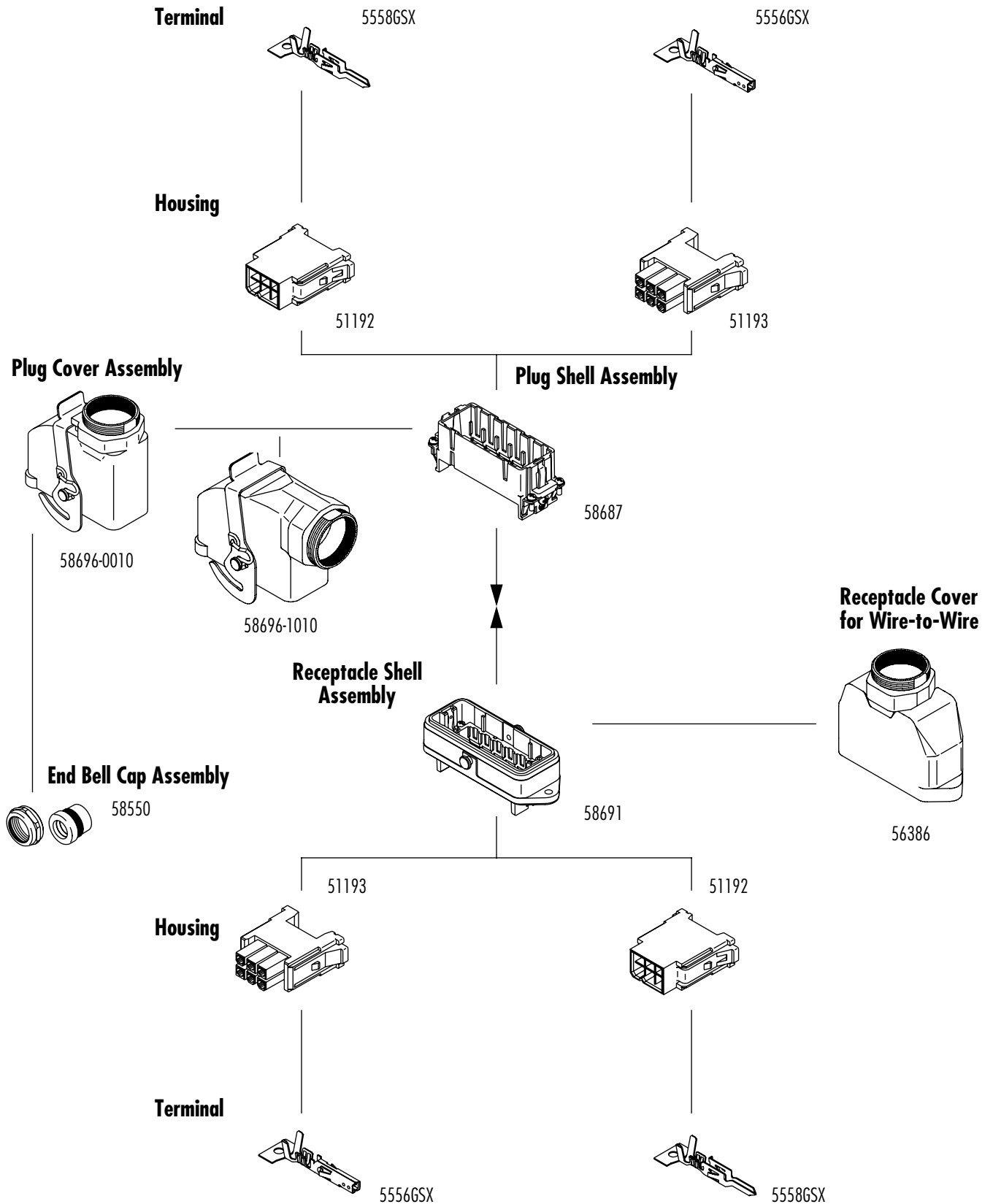

**HMC™**  
**(20A/48 circuits)—IP65**  
**(12A/72 circuits)**  
**Connection System**

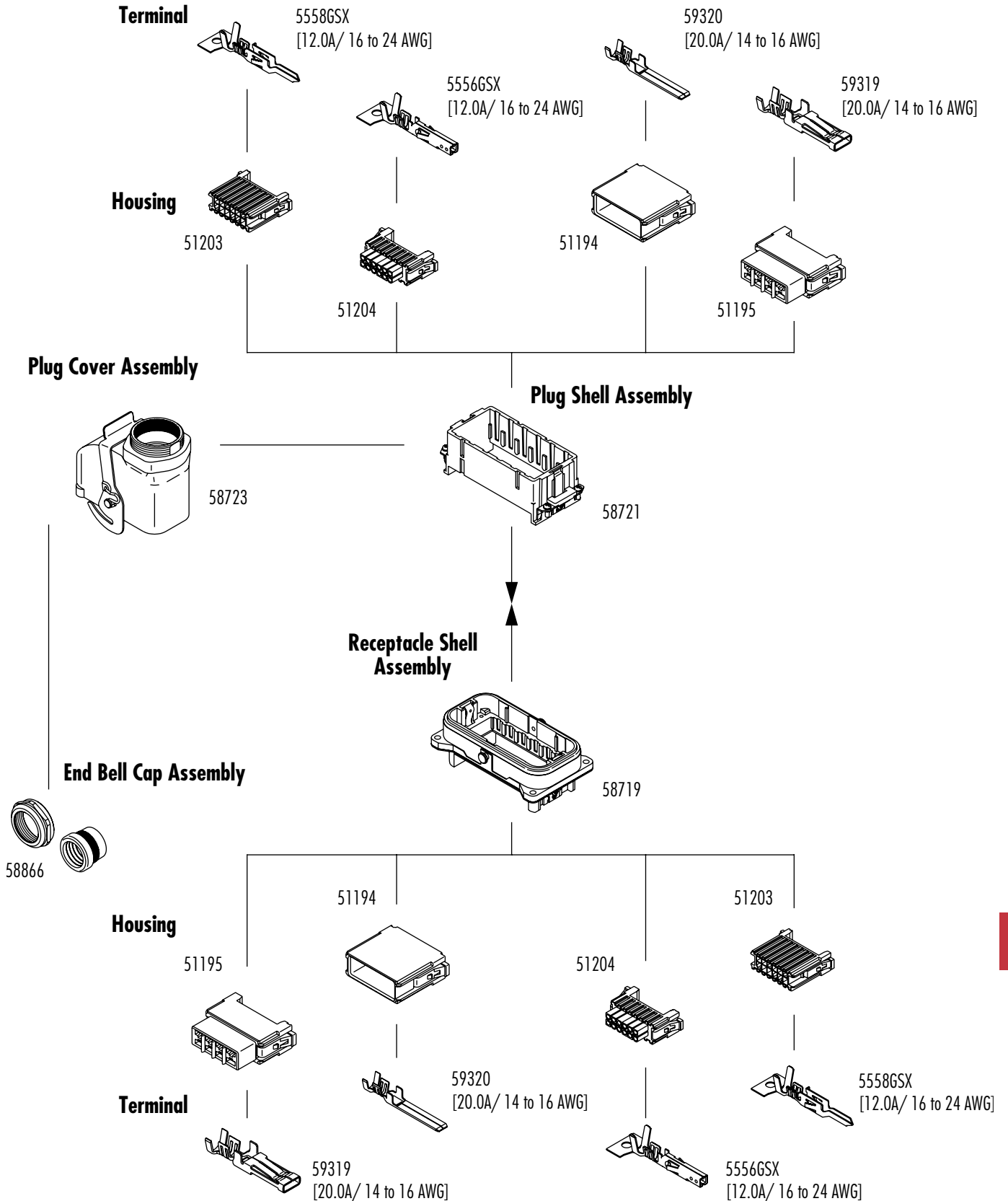

# Mini-HMC™ Rectangular Industrial Connector System

## Introduction



Molex's Mini-HMC system was developed to meet the needs of smaller industrial robotic applications. Mini-HMC provides the ruggedness of traditional Heavy Duty connectors but in a smaller form factor.

Mini-HMC offers many of the same unique features of our standard HMC™ (Heavy Duty Modular) connectors such as "one-touch" lock and removable housings. The system also utilizes the same crimp terminals as our CRC™ (Compact Robotic) industrial connectors.

## Specifications

- Current: 7.0A
- Voltage: 250V
- Circuit Size Range: 40 (fully loaded)
- Contact Resistance: 10 milliohms max.
- Insulation Resistance: 1000 Megohms min.
- Dielectric Strength: AC 1500V/1 minute
- Contact Retention Force: 24.5N
- Durability: 50 cycles

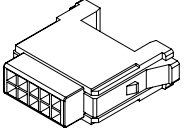
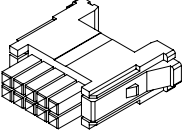
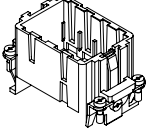
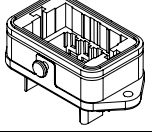
## SELECTION MATRIX

	Description	Order No.	Circuits	Rows	Material	Plating	Packaging
	Plug	<a href="#">500812-1000</a>	10	2	Nylon 66, Glass-Filled UL 94V-0		Bag
	Receptacle	<a href="#">500813-1000</a>	10	2	Nylon 66, Glass-Filled UL 94V-0		Bag
	Plug Shell	<a href="#">500810-0000</a> (A) <a href="#">500810-0010</a> (B)	40	8	Plug Shell: Aluminum Alloy Plug Grounded Terminal: Brass Head Screws: Steel	Nickel	Bag
	Receptacle Shell	<a href="#">500809-0000</a> (A) <a href="#">500809-0010</a> (B)	40	8	Receptacle Shell: Aluminum Alloy Receptacle Ground Terminal: Brass Head Screws: Steel	Nickel	Bag
	Cover	<a href="#">500811-0010</a>	40		Plug Cover: Aluminum Alloy Cover Lock Pin/Level Spring: Stainless Steel	Nickel	Bag
	End Bell Cap Assembly	<a href="#">58550-000*</a>			Cable Cap: Brass Bush: PVC	Nickel	Bag

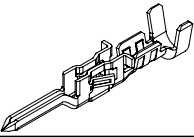
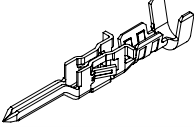
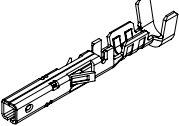
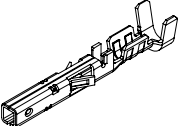
	Description	Order No.	Material	Plating (Contact/Crimp)	Packaging
	AWG# 24-28	<a href="#">56118-8*28</a>	Phosphor Bronze	Gold/Tin	-8228: Reel -8328: Bag
	AWG# 18-22	<a href="#">56119-8*28</a>	Phosphor Bronze	Gold/Tin	-8228: Reel -8328: Bag
	AWG# 24-28	<a href="#">56120-8*28</a>	Phosphor Bronze	Gold/Tin	-8428: Reel -8528: Bag
	AWG# 18-22	<a href="#">56121-8*28</a>	Phosphor Bronze	Gold/Tin	-8428: Reel -8528: Bag

# MX150L™ Sealed Connector System

The pre-assembled, submersible MX150L is a high performance connector system suitable for challenging, rugged and harsh applications.

The MX150L sealed connector system is designed to meet the need for a rugged, environmentally sealed connector system supporting both low-level signal applications as well as power applications up to 40.0A, from on-engine automotive and marine applications to off-road construction equipment applications. The system is comprised of wire-to-wire, wire-to-panel and wire-to-board configurations.

These innovative mat-sealed connectors are based upon the 1.50 and 2.50mm (.059 and .098") blade-type terminals. This design eliminates the need to purchase, handle and crimp individual wire seals to lower applied cost. The mat-seal design is a single silicone-based seal with individual wire openings and a seal cap to protect, securely retain and provide strain relief to the seal. The cost-effective connector design features all-in-one plug and receptacle housings with pre-assembled mat-wire and interfacial connector seals. Integral Terminal Position Assurance (TPA) and optional Connector Position Assurance (CPA) components eliminate time-consuming and costly assembly operations. Completing the application is as simple as crimping the appropriate terminal, inserting the crimped terminal lead and seating the TPA to its final locked position. No additional components are required.

Tooling solutions include FineAdjust™ crimp press applicators for high-volume production, as well as hand tools for low-volume production and field repairs.

## Features and Benefits

- Pre-assembled connector housings, seals, TPA components and mat-seal cap shipped in 1 piece to provide applied labor and cost savings
- Integral TPA assures that crimped terminal leads are properly locked into connector (TPA will not seat into final lock position and connector system will not latch if terminal is not locked properly into position)
- Conforms to UL 1977, which allows for a UL recognized sealed connector system for use in data, signal, control and power applications
- Superior electrical and mechanical performance capabilities surpass performance of most mature competitive products in market
- Audible and tactile clicks on insertion, extraction and mating feedback facilitates reliable mating and terminal loading and removal
- Unused circuits can be blocked using plastic seal plugs, which facilitates flexibility of sealing unused circuits without adding complexity to part numbers and customer inventory
- Integral locking latch with secondary, pre-loaded CPA option assures that connector system is properly latched. CPA will not move to final locked position if connector is not latched. Confirms positive mating of connector
- Sealed panel mount plugs are equipped with a blind hole loss feature that reduces extra hardware while improving the sealing process during assembly by eliminating a leak path
- Integral, 2-way mat and interface seals designed and tested to IEC IP 67 exceeds "waterproof" demands as a true sealed connector system tested under submersed conditions in various fluids
- Easy terminal insertion and extraction provides quick, low-cost field repairs using common screwdriver, needle nose pliers and terminal extraction tool
- Protective mat-seal cap protects, securely retains and provides strain relief to wire seal interface
- Simple crimp, poke and plug application eliminates need to crimp individual wire seals

## MX150L Sealed Connector Systems - Exploded View

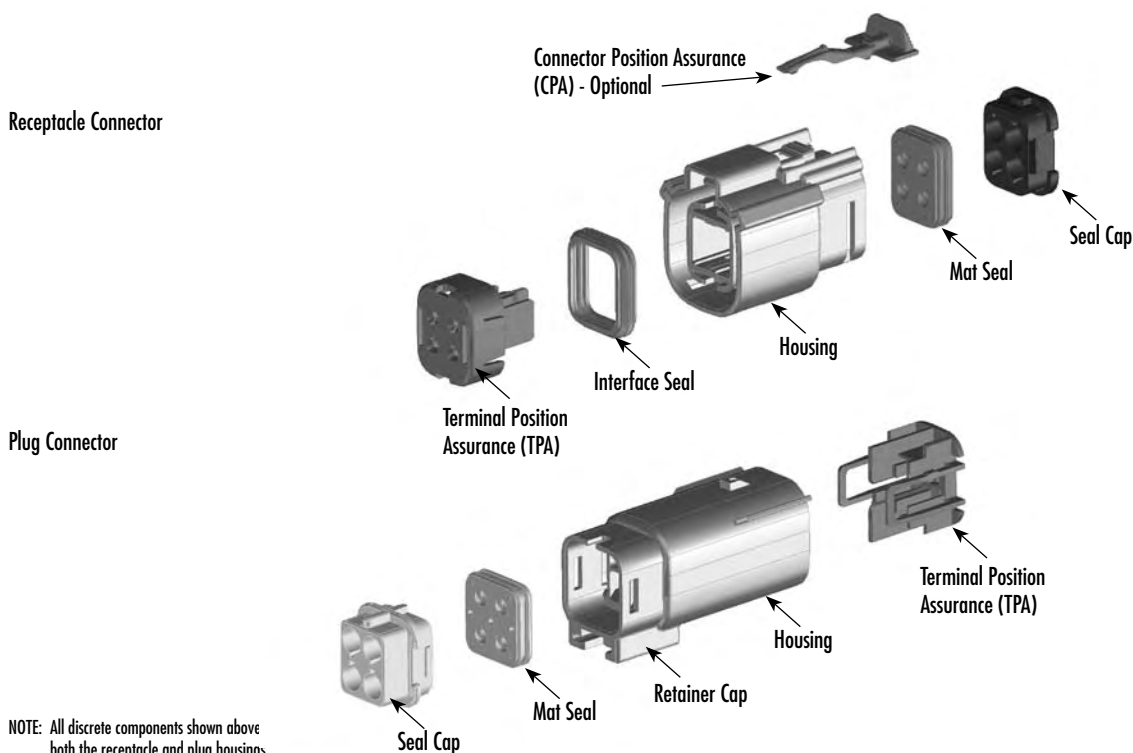

NOTE: All discrete components shown above both the receptacle and plug housings are pre-assembled. Terminals are simply crimped and poked into the housings. No additional wire seals, wedge locks or CPA locks are required.

# MX150L™ Product Overview

14 TO 22 AWG Wire-to-Wire, Wire-to-Board and Panel Mount

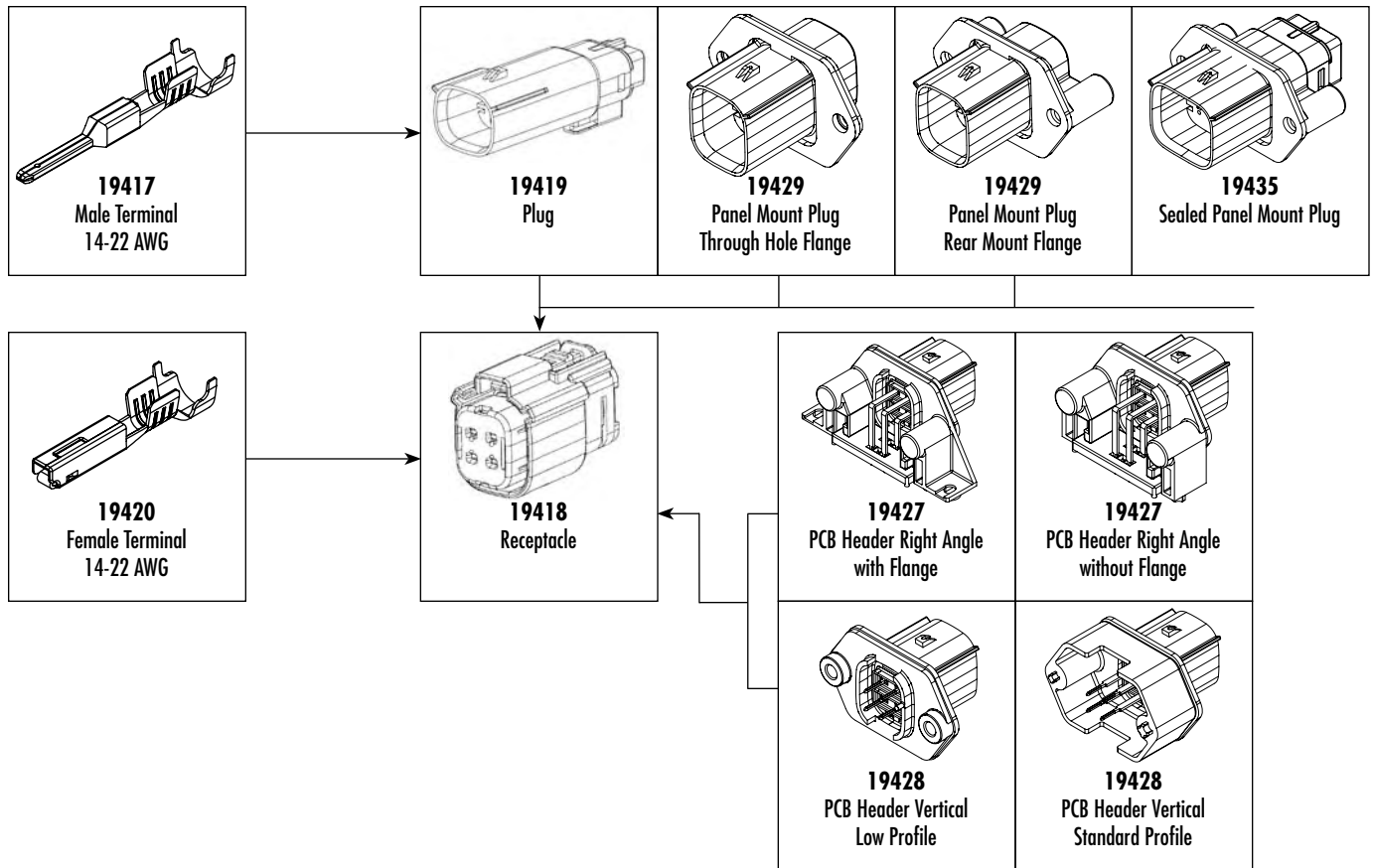

8, 10 and 12 AWG Wire-to-Wire and Panel Mount

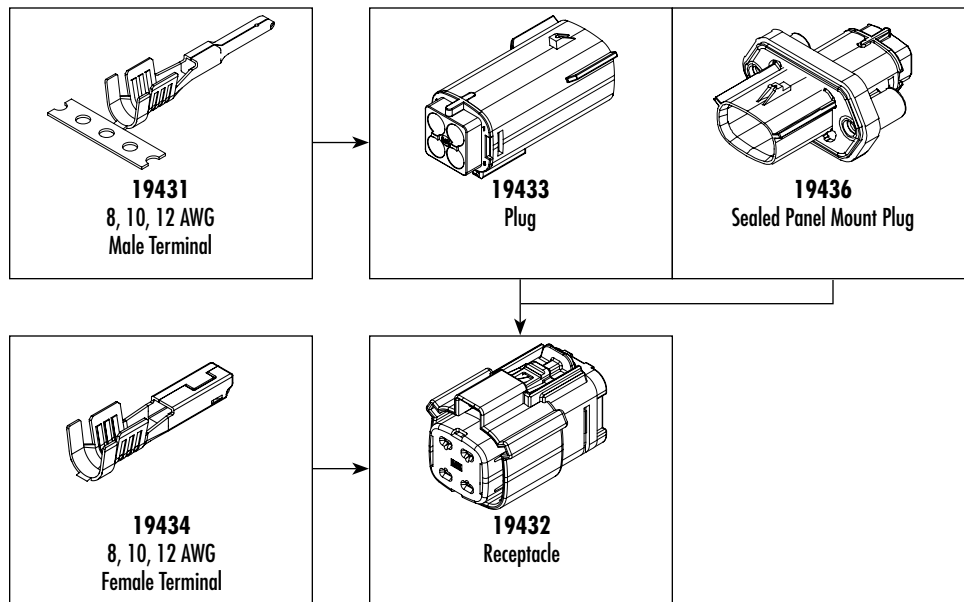



# XRC™ Extra Rugged Circular Sealed Connectors Crimp Terminal

84590

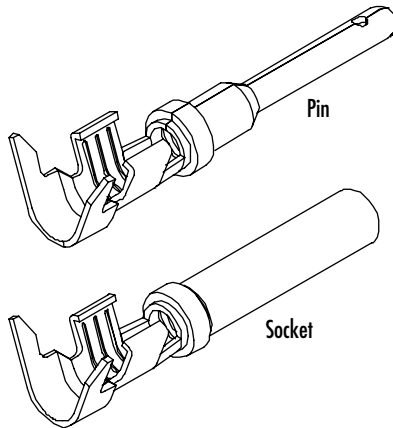

### Reference Information

Packaging: Reel  
 Use With: 84501 and 84507 plug housings  
 84502 and 84508 receptacle housings  
 Designed In: Inches

### Electrical

Current: 18 AWG—10.0A max.  
 16 and 14 AWG—13.0A max.  
 Contact Resistance: 30 milliohms max.

### Mechanical

Contact Retention to Housing: 53.4N (12 lb)  
 Durability: 100 cycles

### Physical

Contact: Copper Alloy  
 Plating: Contact Area—Nickel Overall  
 Underplating—Copper

Order No.	Wire Range (AWG)	Gender	Terminal Size	Insulation Outside Diameter	Lead-free
<a href="#">84590-0021</a>	14 to 18	Pin	16	2.41 to 3.81mm (.095 to .150")	Yes
<a href="#">84590-0022</a>				1.91 to 3.91mm (.075 to .150")	
<a href="#">84590-0020</a>	16 to 18	Socket		1.40 to 2.16mm (.055 to .085")	
<a href="#">84590-0024</a>	14 to 18			2.41 to 3.81mm (.095 to .150")	
<a href="#">84590-0023</a>	16 to 18			1.91 to 3.91mm (.075 to .150")	
<a href="#">84590-0025</a>				1.40 to 2.16mm (.055 to .085")	

# XRC™ Extra Rugged Circular Sealed Connectors Plug Housing

84501

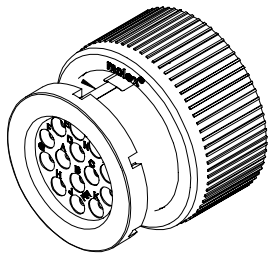

### Features and Benefits

- Environmentally sealed to IP67 standard and protects against the ingress of dust, water and other contaminants to maintain the integrity of the mated pair
- Seal retainer lip is compatible with backshell and overmolding applications
- Bayonet style latch provides quick and easy connections for reduced installation and service time as well as ensures proper depth when mated
- Simple crimp-and-poke technology does not require terminal alignment when installing crimped wires
- Tactile and audible mating feedback facilitates reliable mating

### Reference Information

Packaging: Tray  
 Mates With: 84508 receptacle  
 Use With: 84590 crimp terminals and  
 84509-0002 circuit plug  
 Designed In: Inches

### Electrical

Current: 18 AWG—10.0A max.  
 16 and 14 AWG—13.0A max.  
 Contact Resistance: 30 milliohms max.  
 Dielectric Withstanding Voltage: 1600V AC  
 Insulation Resistance: 1000 Megohms min.

### Mechanical

Contact Retention to Housing: 53.4N (12 lb)  
 Mating Force: 133.5N (30 lb) max.  
 Unmating Force: 26.7N (6 lb) min.  
 Durability: 100 cycles

### Physical

Housing: Glass-filled PBT  
 Seals: Silicone rubber  
 Contact: Copper Alloy  
 Insulation Outside Diameter: Thin wall

Circuits	Shell Size	Order No.	Terminal Insert Configuration	Wire Range	Lead-free
14	18	<a href="#">84501-0001</a>	Pin insert	14 to 18	Yes

# XRC™ Extra Rugged Circular Sealed Connectors Plug Housing

84507

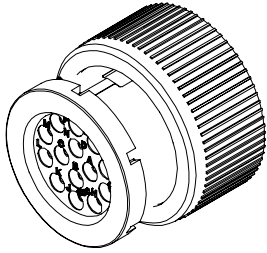

### Features and Benefits

- Environmentally sealed to IP67 standard and protects against the ingress of dust, water and other contaminants to maintain the integrity of the mated pair
- Seal retainer lip is compatible with backshell and overmolding applications
- Bayonet style latch provides quick and easy connections for reduced installation and service time as well as ensures proper depth when mated
- Simple crimp-and-poke technology does not require terminal alignment when installing crimped wires
- Tactile and audible mating feedback facilitates reliable mating

### Reference Information

Packaging: Tray  
 Mates With: 84502 receptacle  
 Use With: 84590 crimp terminals and 84509-0002 circuit plug  
 Designed In: Inches

### Electrical

Current: 18 AWG—10.0A max.  
 16 and 14 AWG—13.0A max.  
 Contact Resistance: 30 milliohms max.  
 Dielectric Withstanding Voltage: 1600V AC  
 Insulation Resistance: 1000 Megohms min.

### Mechanical

Contact Retention to Housing: 53.4N (12 lb)  
 Mating Force: 133.5N (30 lb) max.  
 Unmating Force: 26.7N (6 lb) min.  
 Durability: 100 cycles

### Physical

Housing: Glass-filled PBT  
 Seals: Silicone rubber  
 Contact: Copper Alloy  
 Insulation Outside Diameter: Thin wall

Circuits	Shell Size	Order No.	Terminal Insert Configuration	Wire Range	Lead-free
14	18	<a href="#">84507-0012</a>	Socket insert	14 to 18	Yes

# XRC™ Extra Rugged Circular Sealed Connectors Receptacle Housing

84502

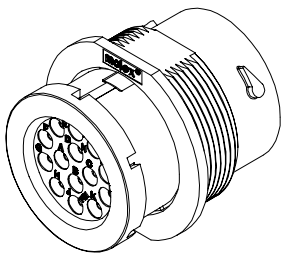

### Features and Benefits

- Environmentally sealed to IP67 standard and protects against the ingress of dust, water and other contaminants to maintain the integrity of the mated pair
- Seal retainer lip is compatible with backshell and overmolding applications
- Bayonet style latch provides quick and easy connections for reduced installation and service time as well as ensures proper depth when mated
- Simple crimp-and-poke technology does not require terminal alignment when installing crimped wires
- Tactile and audible mating feedback facilitates reliable mating

### Reference Information

Packaging: Tray  
 Mates With: 84507 plug  
 Use With: 84590 crimp terminals, 84502-0004 panel mount hex nut (optional) and 84509-0002 circuit plug  
 Designed In: Inches

### Electrical

Current: 18 AWG—10.0A max.  
 16 and 14 AWG—13.0A max.  
 Contact Resistance: 30 milliohms max.  
 Dielectric Withstanding Voltage: 1600V AC  
 Insulation Resistance: 1000 Megohms min.

### Mechanical

Contact Retention to Housing: 53.4N (12 lb)  
 Mating Force: 133.5N (30 lb) max.  
 Unmating Force: 26.7N (6 lb) min.  
 Durability: 100 cycles

### Physical

Housing: Glass-filled PBT  
 Seals: Silicone rubber  
 Contact: Copper Alloy  
 Insulation Outside Diameter: Thin wall

Circuits	Shell Size	Order No.	Terminal Insert Configuration	Wire Range	Lead-free
14	18	<a href="#">84502-0008</a>	Pin insert	14 to 18	Yes

# XRC™ Extra Rugged Circular Sealed Connectors Receptacle Housing

84508

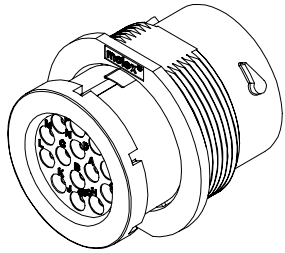

### Features and Benefits

- Environmentally sealed to IP67 standard and protects against the ingress of dust, water and other contaminants to maintain the integrity of the mated pair
- Seal retainer lip is compatible with backshell and overmolding applications
- Bayonet style latch provides quick and easy connections for reduced installation and service time as well as ensures proper depth when mated
- Simple crimp-and-poke technology does not require terminal alignment when installing crimped wires
- Tactile and audible mating feedback facilitates reliable mating

### Reference Information

Packaging: Tray  
 Mates With: 84501 plug  
 Use With: 84590 crimp terminals,  
 84502-0004 panel mount hex nut (optional) and  
 84509-0002 circuit plug  
 Designed In: Inches

### Electrical

Current: 18 AWG—10.0A max.  
 16 and 14 AWG—13.0A max.  
 Contact Resistance: 30 milliohms max.  
 Dielectric Withstanding Voltage: 1600V AC  
 Insulation Resistance: 1000 Megohms min.

### Mechanical

Contact Retention to Housing: 53.4N (12 lb)  
 Mating Force: 133.5N (30 lb) max.  
 Unmating Force: 26.7N (6 lb) min.  
 Durability: 100 cycles

### Physical

Housing: Glass-filled PBT  
 Seals: Silicone rubber  
 Contact: Copper Alloy  
 Insulation Outside Diameter: Thin wall

Circuits	Shell Size	Order No.	Terminal Insert Configuration	Wire Range	Lead-free
14	18	<a href="#">84508-0001</a>	Socket insert	14 to 18	Yes

# XRC™ Extra Rugged Circular Sealed Connectors Circuit Plug

84509

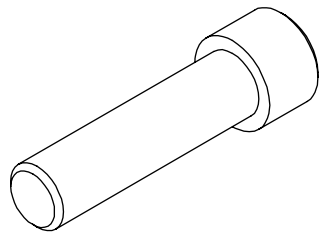

### Features and Benefits

- Optional circuit plug supports the ability to implement sealed blank cavities in both plug and receptacle housings
- Provides the ability to plan for possible future circuit additions while maintaining the sealing integrity of the mated pair

### Reference Information

Packaging: Box  
 Use With: 84501 and 84507 plug housings  
 84502 and 84508 receptacle housings  
 Designed In: Inches

### Physical

Material: PBT, UL 94V-0

Order No.	Contact Size	Color	Lead-free
<a href="#">84509-0002</a>	12 and 16	Natural/White	Yes

# XRC™ Extra Rugged Circular Sealed Connectors Panel Mount Hex Nut

84502

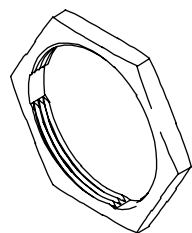

### Reference Information

Packaging: Box  
 Use with: Molex shell size 18 receptacle housings  
 Designed In: Inches

### Physical

Material: PBT, UL 94V-0

Order No.	Color	Lead-free
<a href="#">84502-0004</a>	Black	Yes

# Brad® Nano-Change® (M8) Cordset

120027/120028/120086/120087  
Single and Double-Ended

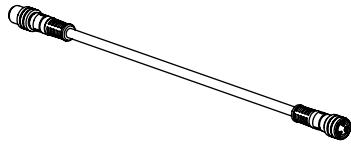

### Features and Benefits

- M8 connector per IEC 61072-2-104
- #24 AWG yellow PVC cable
- Threaded coupling to withstand harsh industrial environments

### Reference Information

UL File No.: E152210

### Electrical

Voltage: 60V AC/75V DC

Current: 3P—4.0A

4P—4.0A

5P—3.0A

### Mechanical

Connector Face: PBT

Molded Body: TPE

O-Ring: Viton

Coupling Nut: Nickel-plated Brass

Cable: Yellow, PVC Cable Jacket, #24 AWG over 19 by #36

Copper stranding, UL style 2661

Outside Diameter:

3P—0.17" (4.3mm)

4P—0.18" (4.6mm)

5P—0.20" (5.1mm)

### Environmental

Protection: IP67

## Single-Ended

Poles	Cable Length (m)	PVC Cable				PUR* Cable			
		Male		Female		Male		Female	
		Old Part No.	Order No.	Old Part No.	Order No.	Old Part No.	Order No.	Old Part No.	Order No.
3	2.0	403006A10M020	<a href="#">120086-0132</a>	403000A10M020	<a href="#">120086-0102</a>	403006P03M020	<a href="#">120027-0911</a>	403000P03M020	<a href="#">120027-0003</a>
	4.0	403006A10M040	<a href="#">120086-0133</a>	403000A10M040	<a href="#">120086-0106</a>	403006P03M040	<a href="#">120027-0453</a>	403000P03M040	<a href="#">120027-1130</a>
	5.0	403006A10M050	<a href="#">120086-0134</a>	403000A10M050	<a href="#">120086-0107</a>	403006P03M050	<a href="#">120086-0474</a>	403000P03M050	<a href="#">120086-0466</a>
	6.0	403006A10M060	<a href="#">120086-0575</a>	403000A10M060	<a href="#">120086-0108</a>	403006P03M060	<a href="#">120086-0583</a>	403000P03M060	<a href="#">120086-0589</a>
	10.0	403006A10M100	<a href="#">120086-0135</a>	403000A10M100	<a href="#">120086-0111</a>	403006P03M100	<a href="#">120027-0933</a>	403000P03M100	<a href="#">120027-0005</a>
4	2.0	404006A10M020	<a href="#">120086-0183</a>	404000A10M020	<a href="#">120086-0144</a>	404006P03M020	<a href="#">120027-0960</a>	404000P03M020	<a href="#">120027-0014</a>
	4.0	404006A10M040	<a href="#">120086-0184</a>	404000A10M040	<a href="#">120086-0146</a>	404006P03M040	<a href="#">120086-0584</a>	404000P03M040	<a href="#">120086-0590</a>
	5.0	404006A10M050	<a href="#">120086-0185</a>	404000A10M050	<a href="#">120086-0147</a>	404006P03M050	<a href="#">120027-1017</a>	404000P03M050	<a href="#">120027-0015</a>
	6.0	404006A10M060	<a href="#">120086-0576</a>	404000A10M060	<a href="#">120086-0148</a>	404006P03M060	<a href="#">120086-0585</a>	404000P03M060	<a href="#">120086-0591</a>
	10.0	404006A10M100	<a href="#">120086-0577</a>	404000A10M100	<a href="#">120086-0155</a>	404006P03M100	<a href="#">120027-1137</a>	404000P03M100	<a href="#">120027-0016</a>
5	2.0	405006A10M020	<a href="#">120086-0206</a>	405000A10M020	<a href="#">120086-0191</a>	405006P02M020	<a href="#">120027-0752</a>	405000P02M020	<a href="#">120027-0709</a>
	4.0	405006A10M040	<a href="#">120086-0207</a>	405000A10M040	<a href="#">120086-0192</a>	405006P02M040	<a href="#">120086-0586</a>	405000P02M040	<a href="#">120086-0592</a>
	5.0	405006A10M050	<a href="#">120086-0208</a>	405000A10M050	<a href="#">120086-0193</a>	405006P02M050	<a href="#">120027-0657</a>	405000P02M050	<a href="#">120086-0475</a>
	6.0	405006A10M060	<a href="#">120086-0541</a>	405000A10M060	<a href="#">120086-0578</a>	405006P02M060	<a href="#">120086-0587</a>	405000P02M060	<a href="#">120086-0593</a>
	10.0	405006A10M100	<a href="#">120086-0579</a>	405000A10M100	<a href="#">120086-0194</a>	405006P02M100	<a href="#">120086-0588</a>	405000P02M100	<a href="#">120086-0594</a>

\* Preferred Version in Europe

## Double-Ended

Poles	Cable Length (m)	PVC Cable		PUR* Cable	
		Male Straight/Female Straight Extension			
		Old Part No.	Order No.	Old Part No.	Order No.
3	0.6	443030A10M006	<a href="#">120087-0071</a>	443030P03M006	<a href="#">120028-0681</a>
	1.0	443030A10M010	<a href="#">120087-0074</a>	443030P03M010	<a href="#">120087-0515</a>
	2.0	443030A10M020	<a href="#">120087-0078</a>	443030P03M020	<a href="#">120028-0682</a>
	3.0	443030A10M030	<a href="#">120087-0079</a>	443030P03M030	<a href="#">120028-0947</a>
	4.0	443030A10M040	<a href="#">120087-0080</a>	443030P03M040	<a href="#">120028-1269</a>
4	5.0	443030A10M050	<a href="#">120087-0081</a>	443030P03M050	<a href="#">120028-0870</a>
	0.6	444030A10M006	<a href="#">120087-0092</a>	444030P03M006	<a href="#">120028-0473</a>
	1.0	444030A10M010	<a href="#">120087-0093</a>	444030P03M010	<a href="#">120028-0365</a>
	2.0	444030A10M020	<a href="#">120087-0095</a>	444030P03M020	<a href="#">120028-0696</a>
	3.0	444030A10M030	<a href="#">120087-0096</a>	444030P03M030	<a href="#">120028-0697</a>
5	4.0	444030A10M040	<a href="#">120087-0097</a>	444030P03M040	<a href="#">120087-0686</a>
	5.0	444030A10M050	<a href="#">120087-0098</a>	444030P03M050	<a href="#">120028-0970</a>
	0.6	445030A10M006	<a href="#">120087-0677</a>	445030P02M006	<a href="#">120087-0687</a>
	1.0	445030A10M010	<a href="#">120087-0112</a>	445030P02M010	<a href="#">120028-1309</a>
	2.0	445030A10M020	<a href="#">120087-0113</a>	445030P02M020	<a href="#">120087-8035</a>
5	3.0	445030A10M030	<a href="#">120087-0678</a>	445030P02M030	<a href="#">120087-0688</a>
	4.0	445030A10M040	<a href="#">120087-0114</a>	445030P02M040	<a href="#">120087-8036</a>
	5.0	445030A10M050	<a href="#">120087-0041</a>	445030P02M050	<a href="#">120028-1310</a>

\* Preferred Version in Europe

# Brad® Nano-Change® (M8) Receptacle

120090

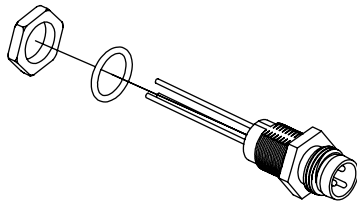

### Features and Benefits

- M8 connector per IEC 61072-2-104
- Nickel-plated Brass body
- IP67 rating on threaded connection

### Reference Information

UL File No.: E152210

### Electrical

Voltage: 60V AC/75V DC

Current: 3P—4.0A

4P—4.0A

5P—3.0A

### Mechanical

Connector Face: PBT

Shell: Nickel-plated Brass

O-Ring: Viton

Wire: PVC; #24 AWG (19 by #36)

### Environmental

Protection: Coupler—NEMA IP67

Snap—NEMA 4, IP65

Poles	Old Part No.	Order No.	Gender
3	4R3P00A27C300	<a href="#">120090-0016</a>	Female
	4R3P06A27C300	<a href="#">120090-0020</a>	Male
4	4R4P00A27C300	<a href="#">120090-0029</a>	Female
	4R4P06A27C300	<a href="#">120090-0032</a>	Male
5	4R5P00A27C300	<a href="#">120090-0037</a>	Female
	4R5P06A27C300	<a href="#">120090-0038</a>	Male

# Brad® Nano-Change® (M8) Attachable Connector

120091

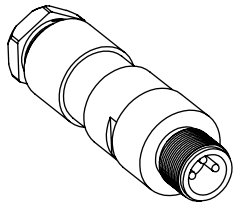

### Features and Benefits

- M8 connector per IEC 61076-2-104
- Allows easy field conversion to threaded connection quick-disconnect
- Solder connections for reliability in vibration applications
- Male and female in both straight and 90° versions

### Electrical

Voltage: 60V AC/75V DC

Current: 4.0A

### Mechanical

Connector Face: PA

Body: PA

Coupling Nut: Nickel-plated Brass

Termination: Solder lugs; accepts conductor to #20 AWG

### Environmental

Protection: IP67

Poles	Old Part No.	Order No.	Orientation	Gender
3	N03FA03124	<a href="#">120091-0001</a>	Straight	Female
	N03FA04124	<a href="#">120091-0003</a>	90°	Female
	N03MA03124	<a href="#">120091-0004</a>	Straight	Male
	N03MA04124	<a href="#">120091-0006</a>	90°	Male
4	N04FA03124	<a href="#">120091-0007</a>	Straight	Female
	N04FA04124	<a href="#">120091-0009</a>	90°	Female
	N04MA03124	<a href="#">120091-0010</a>	Straight	Male
	N04MA04124	<a href="#">120091-0012</a>	90°	Male

# Brad® Nano-Change® (M8) Distribution Box

120113

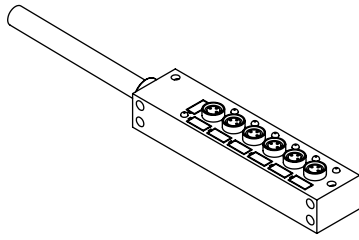

## Features and Benefits

- M8 connector per IEC 61072-2-104
- Connectorized Home Run cable connector version for maximum flexibility
- Flexibility with 4, 8, and 10 ports
- PNP and NPN versions for use with a variety of DC sensor

## Mechanical

Insert: Thermoplastic polyester  
 Housing: PBT  
 Receptacle Housing: Nickel-plated Brass  
 ID Label: ABS  
 O-Ring: Viton  
 Home Run Connector Cabling: M16 14 pole connector, metal shell  
 Cable Jacket: Black PUR/PVC composite, black PUR  
 Diameter: PUR—0.28" (7mm)

## Electrical

Voltage: 10 to 30V DC  
 Current: 2.0A max. per port; 6A total per MPIS unit  
 Indicating Lights: Green LED—power; Yellow LED—function  
 Average LED Life: 100,000 hours

## Environmental

Protection: IP67

	4 Port	6 Port	8 Port	10 Port
V(+) and V(-):	2 x 0.75mm <sup>2</sup>	2 x 0.75mm <sup>2</sup>	2 x 0.75mm <sup>2</sup>	2 x 0.75mm <sup>2</sup>
Control:	4 x 0.34mm <sup>2</sup>	6 x 0.34mm <sup>2</sup>	8 x 0.34mm <sup>2</sup>	Outer
Stranding				
V(+) and V(-):	95 x 0.1mm	85 x 0.1mm	95 x 0.1mm	95 x 0.1mm
Control	42 x 0.1mm	42 x 0.1mm	42 x 0.1mm	42 x 0.1mm

Ports	Old Part No.	Order No.	Description
4	BNY401P-FBC	<a href="#">120113-0023</a>	Top Mount, Connector with Integral Home Run Connector
8	BNY801P-FBC	<a href="#">120113-0029</a>	
10	BNYA01P-FBC	<a href="#">120113-0020</a>	
4	BNY401P-FBP-05	<a href="#">120113-0025</a>	Top Mount with Top Cable Entry, Molded Home Run Cable
8	BNY801P-FBP-05	<a href="#">120113-0032</a>	
10	BNYA01P-FBP-05	<a href="#">120113-0022</a>	
4	BEY401P-FBP-05	<a href="#">120113-0006</a>	
6	BEY601P-FBP-05	<a href="#">120113-0011</a>	
8	BEY801P-FBP-05	<a href="#">120113-0014</a>	
10	BEYA01P-FBP-05	<a href="#">120113-0002</a>	
4	BEY401P-FBP-10	<a href="#">120113-0007</a>	

# Brad® Micro-Change® (M12) Cordset

120006/120065  
Single Keyway  
Single-Ended

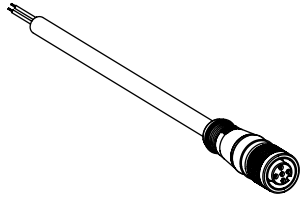

## Features and Benefits

- Single key M12 connector per IEC 61076-2-101
- 22 AWG yellow PVC, PUR thermoplastic elastomer (TPE) cables
- DC color code
- Highly reliable low-resistance contact design with Gold/Palladium Nickel plating

## Reference Information

UL File No.: E152210  
CSA File No.: LR6837

## Electrical

Voltage: 250V AC/DC  
Current: 4.0A

## Mechanical

Connector Face: PUR  
Molded Body: PUR  
O-Ring: Nitrile rubber  
Coupling Nut: Nickel plated brass  
Cable:  
PVC—Yellow 22 AWG PVC jacket and PVC conductor insulation over 26 x 36 Copper strand, 300V, UL Style AWM 2661, CSA AWM I/IT A/B  
TPE—Yellow 22 AWG TPE jacket and PVC conductor insulation over 19 x 34 copper stranding, 300V, High Flex Cable(>10 millionbind cycles), UL ITC/PLTC 105°C, CSA AWM I/IT AB 90°C 300V FT4  
Cable Outside Diameter: 4P—0.20" (5.10mm)  
5P—0.23" (5.80mm)

## Environmental

Protection: IP67

Cable Type	Poles	Length (m)	Straight				Right Angle			
			Male		Female		Male		Female	
			Old Part No.	Order No.	Old Part No.	Order No.	Old Part No.	Order No.	Old Part No.	Order No.
TPE	4	2.0	804006K05M020	<a href="#">120065-1129</a>	804000K05M020	<a href="#">120065-1121</a>	804007K05M020	<a href="#">120065-1691</a>	804001K05M020	<a href="#">120065-1639</a>
		4.0	804006K05M040	<a href="#">120065-1130</a>	804000K05M040	<a href="#">120065-1123</a>	804007K05M040	<a href="#">120065-1692</a>	804001K05M040	<a href="#">120065-1641</a>
		5.0	804006K05M050	<a href="#">120065-1131</a>	804000K05M050	<a href="#">120065-1124</a>	804007K05M050	<a href="#">120065-1693</a>	804001K05M050	<a href="#">120065-1642</a>
		6.0	804006K05M060	<a href="#">120065-1132</a>	804000K05M060	<a href="#">120065-1125</a>	804007K05M060	<a href="#">120065-1694</a>	804001K05M060	<a href="#">120065-1643</a>
		10.0	804006K05M100	<a href="#">120065-1133</a>	804000K05M100	<a href="#">120065-1126</a>	804007K05M100	<a href="#">120065-1695</a>	804001K05M100	<a href="#">120065-1644</a>
PVC	4	2.0	804006A09M020	<a href="#">120065-0414</a>	804000A09M020	<a href="#">120065-0255</a>	804007A09M020	<a href="#">120065-1662</a>	804001A09M020	<a href="#">120065-1551</a>
		4.0	804006A09M040	<a href="#">120065-0418</a>	804000A09M040	<a href="#">120065-0261</a>	804007A09M040	<a href="#">120065-1665</a>	804001A09M040	<a href="#">120065-1555</a>
		5.0	804006A09M050	<a href="#">120065-0419</a>	804000A09M050	<a href="#">120065-0265</a>	804007A09M050	<a href="#">120065-1666</a>	804001A09M050	<a href="#">120065-1558</a>
		6.0	804006A09M060	<a href="#">120065-0421</a>	804000A09M060	<a href="#">120065-0268</a>	804007A09M060	<a href="#">120065-1668</a>	804001A09M060	<a href="#">120065-1562</a>
		10.0	804006A09M100	<a href="#">120065-0425</a>	804000A09M100	<a href="#">120065-0277</a>	804007A09M100	<a href="#">120065-1669</a>	804001A09M100	<a href="#">120065-1567</a>
PUR*	4	2.0	804006P03M020	<a href="#">120006-0570</a>	804000P03M020	<a href="#">120006-0018</a>	804007P03M020	<a href="#">120006-0592</a>	804001P03M020	<a href="#">120006-0024</a>
		4.0	804006P03M040	<a href="#">120065-2141</a>	804000P03M040	<a href="#">120065-2143</a>	804007P03M040	<a href="#">120065-2145</a>	804001P03M040	<a href="#">120065-2147</a>
		5.0	804006P03M050	<a href="#">120006-0047</a>	804000P03M050	<a href="#">120006-0019</a>	804007P03M050	<a href="#">120006-0594</a>	804001P03M050	<a href="#">120006-0025</a>
		6.0	804006P03M060	<a href="#">120065-2142</a>	804000P03M060	<a href="#">120065-2144</a>	804007P03M060	<a href="#">120065-2146</a>	804001P03M060	<a href="#">120065-8206</a>
		10.0	804006P03M100	<a href="#">120006-0572</a>	804000P03M100	<a href="#">120065-1782</a>	804007P03M100	<a href="#">120006-0595</a>	804001P03M100	<a href="#">120065-1787</a>
TPE	5	2.0	805006K03M020	<a href="#">120065-1374</a>	805000K03M020	<a href="#">120065-1367</a>	805007K03M020	<a href="#">120065-2159</a>	805001K03M020	<a href="#">120065-1720</a>
		4.0	805006K03M040	<a href="#">120065-2150</a>	805000K03M040	<a href="#">120065-1369</a>	805007K03M040	<a href="#">120065-2160</a>	805001K03M040	<a href="#">120065-1721</a>
		5.0	805006K03M050	<a href="#">120065-2151</a>	805000K03M050	<a href="#">120065-1370</a>	805007K03M050	<a href="#">120065-2161</a>	805001K03M050	<a href="#">120065-1722</a>
		6.0	805006K03M060	<a href="#">120065-2152</a>	805000K03M060	<a href="#">120065-1371</a>	805007K03M060	<a href="#">120065-2162</a>	805001K03M060	<a href="#">120065-1723</a>
		10.0	805006K03M100	<a href="#">120065-2153</a>	805000K03M100	<a href="#">120065-1373</a>	805007K03M100	<a href="#">120065-2163</a>	805001K03M100	<a href="#">120065-2155</a>
PVC	5	2.0	805006A09M020	<a href="#">120065-0523</a>	805000A09M020	<a href="#">120065-0471</a>	805007A09M020	<a href="#">120065-1724</a>	805001A09M020	<a href="#">120065-1697</a>
		4.0	805006A09M040	<a href="#">120065-0526</a>	805000A09M040	<a href="#">120065-0476</a>	805007A09M040	<a href="#">120065-1726</a>	805001A09M040	<a href="#">120065-1700</a>
		5.0	805006A09M050	<a href="#">120065-0528</a>	805000A09M050	<a href="#">120065-0479</a>	805007A09M050	<a href="#">120065-1727</a>	805001A09M050	<a href="#">120065-1701</a>
		6.0	805006A09M060	<a href="#">120065-0531</a>	805000A09M060	<a href="#">120065-0483</a>	805007A09M060	<a href="#">120065-1728</a>	805001A09M060	<a href="#">120065-1703</a>
		10.0	805006A09M100	<a href="#">120065-0533</a>	805000A09M100	<a href="#">120065-0487</a>	805007A09M100	<a href="#">120065-2123</a>	805001A09M100	<a href="#">120065-1706</a>
PUR*	5	2.0	805006P03M020	<a href="#">120006-0680</a>	805000P03M020	<a href="#">120006-0647</a>	805007P03M020	<a href="#">120006-0697</a>	805001P03M020	<a href="#">120006-0663</a>
		4.0	805006P03M040	<a href="#">120065-2157</a>	805000P03M040	<a href="#">120065-8020</a>	805007P03M040	<a href="#">120006-0699</a>	805001P03M040	<a href="#">120065-8184</a>
		5.0	805006P03M050	<a href="#">120006-0682</a>	805000P03M050	<a href="#">120065-1792</a>	805007P03M050	<a href="#">120065-8186</a>	805001P03M050	<a href="#">120065-1793</a>
		6.0	805006P03M060	<a href="#">120006-2082</a>	805000P03M060	<a href="#">120065-2154</a>	805007P03M060	<a href="#">120065-2149</a>	805001P03M060	<a href="#">120065-2156</a>
		10.0	805006P03M100	<a href="#">120065-2158</a>	805000P03M100	<a href="#">120006-0649</a>	805007P03M100	<a href="#">120065-5006</a>	805001P03M100	<a href="#">120006-0664</a>

\*Preferred Version in Europe

# Brad® Micro-Change® (M12) Cordset

**120066**  
**Double-Ended**  
**Single Keyway**

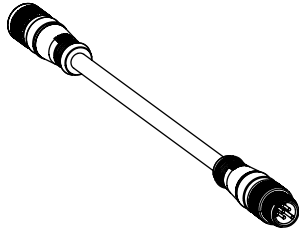

### Features and Benefits

- Single key M12 connector per IEC 61076-2-101
- 22 AWG yellow PVC and thermoplastic elastomer (TPE) cables
- DC color code
- Highly reliable low-resistance contact design with Gold/Palladium Nickel plating

### Reference Information

UL File No.: E152210  
 CSA File No.: LR6837

### Electrical

Voltage: 250V AC/DC  
 Current: 4.0A

### Mechanical

Connector Face: PUR  
 Molded Body: PUR  
 O-Ring: Nitrile rubber  
 Coupling Nut: Nickel plated brass  
 Cable:  
 PVC—Yellow 22 AWG PVC jacket and PVC conductor insulation over 26 x 36 Copper strand, 300V, UL Style AWM 2661, CSA AWM I/IT A/B  
 TPE—Yellow 22 AWG TPE jacket and PVC conductor insulation over 19 x 34 copper stranding, 300V, High Flex Cable(>10 millionbind cycles), UL ITC/PLTC 105°C, CSA AWM I/IT AB 90°C 300V FT4  
 Cable Outside Diameter: 4P—0.20" (5.10mm)  
 5P—0.23" (5.80mm)

### Environmental

Protection: IP67

Cable Type	Poles	Length (m)	Female/Male Extension	
			Old Part No.	Order No.
PVC	4	0.6	884030A09M006	<a href="#">120066-0262</a>
		1.0	884030A09M010	<a href="#">120066-0266</a>
		2.0	884030A09M020	<a href="#">120066-0271</a>
		4.0	884030A09M040	<a href="#">120066-0279</a>
		5.0	884030A09M050	<a href="#">120066-0284</a>
TPE	4	0.6	884030K05M006	<a href="#">120066-0686</a>
		1.0	884030K05M010	<a href="#">120066-0687</a>
		2.0	884030K05M020	<a href="#">120066-0689</a>
		3.0	884030K05M030	<a href="#">120066-0690</a>
		4.0	884030K05M040	<a href="#">120066-0691</a>
	5	5.0	884030K05M050	<a href="#">120066-0692</a>
		0.6	885030K03M006	<a href="#">120066-1033</a>
		1.0	885030K03M010	<a href="#">120066-1034</a>
		2.0	885030K03M020	<a href="#">120066-1035</a>
		4.0	885030K03M040	<a href="#">120066-1037</a>
PUR*	4	5.0	885030K03M050	<a href="#">120066-1038</a>
		0.6	884030F03M006	<a href="#">120007-0487</a>
		1.0	884030F03M010	<a href="#">120007-0488</a>
		2.0	884030F03M020	<a href="#">120007-0489</a>
		4.0	884030F03M040	<a href="#">120007-2803</a>
5.0	884030F03M050	<a href="#">120007-0490</a>		

\*Preferred Version in Europe



# Brad® Micro-Change® (M12) Receptacle

**120070**  
Single Keyway

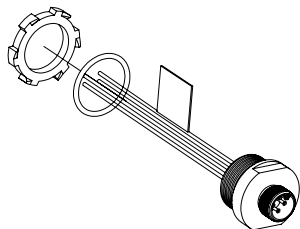

### Features and Benefits

- Single key M12 connector per IEC 61076-2-101
- 22 AWG PVC 12 inch leads—DC color code, epoxy potted
- Black anodized aluminum shell
- Used in control panels, junction boxes and sensors

### Reference Information

UL File No.: 3P and 4P E152210, 5P UL recognized  
CSA File No.: LR6837

### Electrical

Voltage: 250V AC/DC  
Current: 4.0A

### Mechanical

Shell: Black anodized aluminum  
Insert: Nylon 6/6  
Conductors: 22 AWG with PVC insulation over 26 by #36  
Copper stranding, 300V, UL Style 1061, CSA AWM SR  
O-Ring: Nitrile Rubber

### Environmental

Protection: IP67

Poles	Male		Mounting Thread	Female		Mounting Thread
	Old Part No.	Order No.		Old Part No.	Order No.	
4	8R4006A18A120	<a href="#">120070-0184</a>	1/2" - 14NPT	8R4A00A18A120	<a href="#">120070-0114</a>	1/4" - 18NPT
5	8R5006A18A120	<a href="#">120070-0252</a>		8R5A00A18A120	<a href="#">120070-0201</a>	

\*Note: Other mounting threads available, contact Molex.

# Brad® Micro-Change® (M12) Field Attachables

**120071**  
Single Keyway

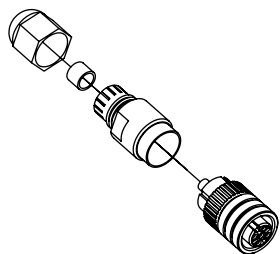

### Features and Benefits

- Single key M12 connector per IEC 61076-2-101
- Screw terminal connection accepts up to 18 AWG conductors
- Easy field installation of quick-disconnect design
- For use with all standard single keyway M12 receptacles and cordsets

### Reference Information

CSA File No.: LR6837

### Electrical

Voltage: 4P—250V AC, 300V DC  
5P—30V AC, 36V DC  
Current: 4.0A

### Mechanical

Connector Face: Polyamide  
Molded Body: Polyamide  
Contact: Silver plated Brass  
Coupling Nut: Nickel plated Brass  
Grommet: Nitrile rubber  
Maximum Conductor Size: 18 AWG

### Environmental

Protection: IP67

Poles	Male		Female		Orientation	Description
	Old Part No.	Order No.	Old Part No.	Order No.		
4	8A4006-31	<a href="#">120071-0038</a>	8A4000-31	<a href="#">120071-0035</a>	Straight	With PG 7 Cable Fitting (0.13 - 0.26" O.D. [3.3-6.6mm] cable)
	8A4007-31	<a href="#">120071-0040</a>	8A4001-31	<a href="#">120071-0037</a>		
5	8A5006-31	<a href="#">120071-0045</a>	8A5000-31	<a href="#">120071-0041</a>	Straight	
	8A5007-31	<a href="#">120071-0049</a>	8A5001-31	<a href="#">120071-0044</a>		
4	8A4006-32	<a href="#">120071-0039</a>	8A4000-32	<a href="#">120071-0036</a>	Straight	With PG 9 Cable Fitting (0.16 - 0.32" O.D. [4.1-8.1mm] cable)
5	8A5006-32	<a href="#">120071-0047</a>	8A5000-32	<a href="#">120071-0043</a>		

# Brad® Ultra-Lock® (M12) Cordset

**120079**  
**Single-Ended**

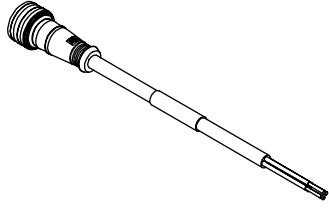

### Features and Benefits

- Simply push down to connect and pull up to disconnect
- Surpasses the performance and reliability of traditional threaded connectors to deliver increased productivity and cost savings
- Ultra-lock connectors incorporate a unique radial seal and mechanical locking design that deliver unsurpassed performance

### Electrical

Voltage: 3P and 4P—250V  
5P—60V  
Insulation Resistance: >10<sup>9</sup> ohms  
Rated Current T Amb. 40C: 4.0A  
Contact Resistance: <5 milliohms

### Mechanical

Connector Face: PUR  
Connector Body: PUR  
Locking Mechanism: Nickel-plated Brass  
Contact: Male—Brass  
Female—Phosphor Bronze  
Contact Plating: Gold over Nickel  
O-Ring: Viton

### Environmental

Pollution Degree (IEC 60 664-1): 3  
Protection: IP67/69K

Poles	Cable Type	Length (m)	Male Straight		Female Straight		Female Right Angle		
			Old Part No.	Order No.	Old Part No.	Order No.	Old Part No.	Order No.	
4	PVC	2.0					W04001A09M020	<a href="#">120079-0232</a>	
		4.0					W04001A09M040	<a href="#">120079-0233</a>	
		5.0					W04001A09M050	<a href="#">120079-0234</a>	
		6.0					W04001A09M060	<a href="#">120079-0235</a>	
		10.0					W04001A09M100	<a href="#">120079-0195</a>	
	TPE	2.0	W04006K05M020	<a href="#">120079-0156</a>	W04000K05M020	<a href="#">120079-0149</a>	W04001K05M020	<a href="#">120079-0221</a>	
		4.0	W04006K05M040	<a href="#">120079-0143</a>	W04000K05M040	<a href="#">120079-0148</a>	W04001K05M040	<a href="#">120079-0183</a>	
		5.0	W04006K05M050	<a href="#">120079-0142</a>	W04000K05M050	<a href="#">120079-0147</a>	W04001K05M050	<a href="#">120079-0184</a>	
		6.0	W04006K05M060	<a href="#">120079-0141</a>	W04000K05M060	<a href="#">120079-0134</a>	W04001K05M060	<a href="#">120079-0185</a>	
		10.0	W04006K05M100	<a href="#">120079-0140</a>	W04000K05M100	<a href="#">120079-0145</a>	W04001K05M100	<a href="#">120079-0186</a>	
	PUR*	2.0	W04006P03M020	<a href="#">120079-8006</a>	W04000P03M020	<a href="#">120079-8012</a>	W04001P03M020	<a href="#">120079-8013</a>	
		4.0	W04006P03M040	<a href="#">120079-5064</a>	W04000P03M040	<a href="#">120079-5068</a>	W04001P03M040	<a href="#">120079-5071</a>	
		5.0	W04006P03M050	<a href="#">120079-5065</a>	W04000P03M050	<a href="#">120079-5069</a>	W04001P03M050	<a href="#">120079-8007</a>	
		6.0	W04006P03M060	<a href="#">120079-5066</a>	W04000P03M060	<a href="#">120079-5070</a>	W04001P03M060	<a href="#">120079-5073</a>	
		10.0	W04006P03M100	<a href="#">120079-8011</a>	W04000P03M100	<a href="#">120079-8010</a>	W04001P03M100	<a href="#">120079-5072</a>	
	5	PVC	2.0	W05006A09M020	<a href="#">120079-0092</a>	W05000A09M020	<a href="#">120079-0109</a>	W05001A09M020	<a href="#">120079-0223</a>
			4.0	W05006A09M040	<a href="#">120079-0091</a>	W05000A09M040	<a href="#">120079-0096</a>	W05001A09M040	<a href="#">120079-0202</a>
			5.0	W05006A09M050	<a href="#">120079-0090</a>	W05000A09M050	<a href="#">120079-0095</a>	W05001A09M050	<a href="#">120079-0203</a>
6.0			W05006A09M060	<a href="#">120079-0089</a>	W05000A09M060	<a href="#">120079-0094</a>	W05001A09M060	<a href="#">120079-0204</a>	
10.0			W05006A09M100	<a href="#">120079-0088</a>	W05000A09M100	<a href="#">120079-0093</a>	W05001A09M100	<a href="#">120079-0205</a>	
PUR*		2.0	W05006P03M020	<a href="#">120079-5055</a>			W05001P03M020	<a href="#">120079-5088</a>	
		4.0	W05006P03M040	<a href="#">120079-5079</a>			W05001P03M040	<a href="#">120079-5089</a>	
		5.0	W05006P03M050	<a href="#">120079-5080</a>			W05001P03M050	<a href="#">120079-5090</a>	
		6.0	W05006P03M060	<a href="#">120079-5081</a>			W05001P03M060	<a href="#">120079-5091</a>	
		10.0	W05006P03M100	<a href="#">120079-5082</a>			W05001P03M100	<a href="#">120079-5092</a>	

\*Preferred Version in Europe

# Brad® Ultra-Lock® (M12) Cordset

**120080**  
**Doubled-Ended**

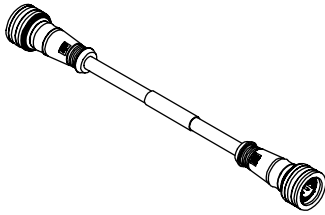

### Features and Benefits

- Simply push down to connect and pull up to disconnect
- Surpasses the performance and reliability of traditional threaded connectors to deliver increased productivity and cost savings
- Ultra-lock connectors incorporate a unique radial seal and mechanical locking design that deliver unsurpassed performance

### Electrical

Voltage: 4P—250V  
5P—60V  
Insulation Resistance: >10<sup>9</sup> ohms  
Rated Current T Amb.: 4.0A  
Contact Resistance: <5 milliohms

### Mechanical

Connector Face: PUR  
Contact Carrier: PUR  
Locking Mechanism: Nickel-plated Brass  
Contact: Male—Brass  
Female—Phosphor Bronze  
Contact Plating: Gold over Nickel  
O-Ring: Viton  
Durability: 30,000 mate/demate

### Environmental

Pollution Degree (IEC 60 664-1): 3  
Protection: IP67/69K

Poles	Cable Type	Length (m)	Ultra-Lock Male/Threaded Female Extension		Ultra-Lock Male/ Ultra-Lock Female Extension	
			Old Material No.	Order No.	Old Material No.	Order No.
4	PVC	0.6	8W4030A09M006	<a href="#">120080-0042</a>	WW4030A09M006	<a href="#">120080-0009</a>
		1.0	8W4030A09M010	<a href="#">120080-0043</a>	WW4030A09M010	<a href="#">120080-0403</a>
		2.0	8W4030A09M020	<a href="#">120080-0044</a>	WW4030A09M020	<a href="#">120080-0331</a>
		3.0	8W4030A09M030	<a href="#">120080-0449</a>	WW4030A09M030	<a href="#">120080-0450</a>
		4.0	8W4030A09M040	<a href="#">120080-0045</a>	WW4030A09M040	<a href="#">120080-0332</a>
	TPE	0.6	8W4030K05M006	<a href="#">120080-0455</a>	WW4030K05M006	<a href="#">120080-5054</a>
		1.0	8W4030K05M010	<a href="#">120080-0073</a>	WW4030K05M010	<a href="#">120080-0417</a>
		2.0	8W4030K05M020	<a href="#">120080-0074</a>	WW4030K05M020	<a href="#">120080-0406</a>
		3.0	8W4030K05M030	<a href="#">120080-0442</a>	WW4030K05M030	<a href="#">120080-5055</a>
		4.0	8W4030K05M040	<a href="#">120080-0075</a>	WW4030K05M040	<a href="#">120080-0405</a>
	PUR*	0.6	8W4030P03M006	<a href="#">120080-0076</a>	WW4030K05M050	<a href="#">120080-0404</a>
		1.0	8W4030P03M010	<a href="#">120080-5028</a>	WW4030P03M006	<a href="#">120080-5044</a>
		2.0	8W4030P03M020	<a href="#">120080-5029</a>	WW4030P03M010	<a href="#">120080-5045</a>
		3.0	8W4030P03M030	<a href="#">120080-5030</a>	WW4030P03M020	<a href="#">120080-5018</a>
		4.0	8W4030P03M040	<a href="#">120080-8004</a>	WW4030P03M030	<a href="#">120080-5046</a>
5	PVC	0.6	8W4030P03M050	<a href="#">120080-5031</a>	WW4030P03M040	<a href="#">120080-5047</a>
		1.0	8W4030P03M050	<a href="#">120080-8005</a>	WW4030P03M050	<a href="#">120080-5048</a>
		2.0	8W5030A09M006	<a href="#">120080-0451</a>	WW4030P03M050	<a href="#">120080-5048</a>
		3.0	8W5030A09M010	<a href="#">120080-0059</a>	WW5030A09M006	<a href="#">120080-0453</a>
		4.0	8W5030A09M020	<a href="#">120080-0060</a>	WW5030A09M010	<a href="#">120080-0325</a>
	PUR*	0.6	8W5030A09M030	<a href="#">120080-0452</a>	WW5030A09M020	<a href="#">120080-0313</a>
		1.0	8W5030A09M040	<a href="#">120080-0061</a>	WW5030A09M030	<a href="#">120080-0454</a>
		2.0	8W5030A09M050	<a href="#">120080-0062</a>	WW5030A09M040	<a href="#">120080-0312</a>
		3.0	8W5030P03M006	<a href="#">120080-5032</a>	WW5030A09M050	<a href="#">120080-0311</a>
		4.0	8W5030P03M010	<a href="#">120080-5033</a>	WW5030P03M006	<a href="#">120080-5049</a>
	PUR*	0.6	8W5030P03M020	<a href="#">120080-5034</a>	WW5030P03M010	<a href="#">120080-5050</a>
		1.0	8W5030P03M030	<a href="#">120080-5035</a>	WW5030P03M020	<a href="#">120080-5051</a>
		2.0	8W5030P03M040	<a href="#">120080-5036</a>	WW5030P03M030	<a href="#">120080-5052</a>
		3.0	8W5030P03M050	<a href="#">120080-5037</a>	WW5030P03M040	<a href="#">120080-5053</a>
		4.0	8W5030P03M050	<a href="#">120080-5037</a>	WW5030P03M050	<a href="#">120080-5019</a>

\*Preferred Version in Europe

# Brad® Ultra-Lock® (M12) Receptacle

**120025/120084**  
**Single Keyway**

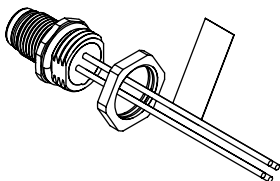

### Features and Benefits

- Mating receptacles for Ultra-Lock® cordsets
- 0.34mm<sup>2</sup> (22 AWG) PVC 30cm wire leads, DC color code
- Fully potted to maintain water tight rating of enclosure
- Used in control panels, junction boxes and sensors
- Offered with wire leads or PCB pins for easy incorporation into devices

### Electrical

Voltage: 4P—250V AC/DC  
5P—60V AC/DC  
Current: 4.0A

### Mechanical

Shell: Nickel-plated Brass  
Insert: PUR  
Conductors: 0.34mm<sup>2</sup> (22 AWG) PVC insulation  
O-Ring: Viton

### Environmental

Protection: IP67/IP69K

Poles	Mounting Thread	Front Panel Mount				Rear Panel Mount			
		Male		Female		Male		Female	
		Old Part No.	Order No.	Old Part No.	Order No.	Old Part No.	Order No.	Old Part No.	Order No.
4	M16 x 1	WR4U26E03C300	<a href="#">120025-0005</a>	WR4U20E03C300	<a href="#">120025-0006</a>	WR4U46000	<a href="#">120084-0028</a>	WR4U40000	<a href="#">120084-0029</a>
5		WR5U26E03C300	<a href="#">120025-0007</a>	WR5U20E03C300	<a href="#">120025-0008</a>	WR5U46000	<a href="#">120084-0031</a>	WR5U40000	<a href="#">120084-0030</a>

# Brad® Micro-Change® (1/2"-20 UNC) Cordset

**120072**  
Single-Ended  
Dual Keyway

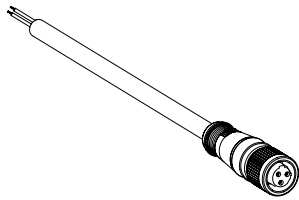

### Features and Benefits

- Dual key connector with 1/2"-20 UNF coupler
- 22 AWG yellow PVC cable with metallic braid—auto color code
- Low-resistance contact design with Gold/Palladium Nickel plating

### Reference Information

UL File No.: E152210  
CSA File No.: LR6837

### Electrical

Voltage: 250V AC/DC  
Current: 4.0A

### Mechanical

Connector Face: Nylon 6/6  
Molded Body: PVC  
O-Ring: Nitrile rubber  
Coupling Nut: Zinc diecast with black epoxy coat  
Cable: Yellow 22 AWG PVC jacket 70% metallic braid and PVC conductor insulation over 26 by #36 Copper stranding, 300V, UL Style 2661, CSA AWM I/II A/B  
Outside Diameter (22 AWG with 70% Braid):  
3P—0.23" (5.80mm)  
4P—0.25" (6.40mm)  
5P—0.26" (6.60mm)

### Environmental

Protection: IP67

Poles	Length	Male Straight		Female Straight	
		Old Part No.	Order No.	Old Part No.	Order No.
3	6.0'	703006D02F060	<a href="#">120072-0302</a>	703000D02F060	<a href="#">120072-0171</a>
	12.0'	703006D02F120	<a href="#">120072-0305</a>	703000D02F120	<a href="#">120072-0178</a>
	20.0'	703006D02F200	<a href="#">120072-0308</a>	703000D02F200	<a href="#">120072-0185</a>
4	6.0'	704006D02F060	<a href="#">120072-0445</a>	704000D02F060	<a href="#">120072-0356</a>
	12.0'	704006D02F120	<a href="#">120072-0447</a>	704000D02F120	<a href="#">120072-0359</a>
	20.0'	704006D02F200	<a href="#">120072-0450</a>	704000D02F200	<a href="#">120072-0364</a>
5	6.0'	705006D02F060	<a href="#">120072-0551</a>	705000D02F060	<a href="#">120072-0471</a>
	12.0'	705006D02F120	<a href="#">120072-0553</a>	705000D02F120	<a href="#">120072-0474</a>
	20.0'	705006D02F200	<a href="#">120072-0555</a>	705000D02F200	<a href="#">120072-0477</a>

# Brad® Micro-Change® (1/2"-20 UNC) Receptacle

**120074**  
Dual Keyway

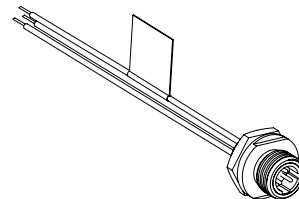

### Features and Benefits

- Dual keyway connector with 1/2"-20 UNC coupler
- 22 AWG PVC 12 inch leads—auto color code, epoxy potted
- Gray anodized aluminum shell
- Used in control panels, junction boxes and sensors

### Reference Information

UL File No.: E152210  
CSA File No.: LR6837

### Electrical

Voltage: 250V AC/DC  
Current: 4.0A

### Mechanical

Shell: Gray anodized aluminum  
Insert: Nylon 6/6  
O-Ring: Nitrile Rubber  
Conductors: 22 AWG with PVC insulation over 26 by #36 Copper stranding, 300V, UL Style 1061, CSA AWM SR

### Environmental

Protection: IP67

Poles	Male		Female		Mounting Thread
	Old Part No.	Order No.	Old Part No.	Order No.	
3	7R3A06A19A120	<a href="#">120074-0079</a>	7R3A00A19A120	<a href="#">120074-0058</a>	1/4" - NPT
4	7R4A06A19A120	<a href="#">120074-0140</a>	7R4A00A19A120	<a href="#">120074-0122</a>	
5	7R5A06A19A120	<a href="#">120074-0190</a>	7R5A00A19A120	<a href="#">120074-0178</a>	

\*Note: Other mounting threads available, contact Molex.

# Brad® Micro-Change® (½"-20 UNF) Field Attachables

**120075**  
**Dual Keyway**

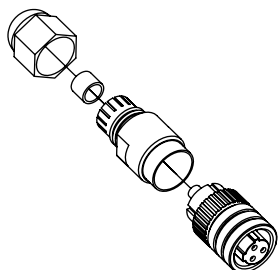

### Features and Benefits

- Dual keyway connector with ½"-20 UNC coupler
- Screw terminal connection accepts up to 18 AWG conductors
- Easy field installation of quick-disconnect design
- For use with all standard dual keyway ½"-20 UNF receptacles and cordsets

### Electrical

Voltage: 250V AC/DC  
Current: 3P—4.0A

### Mechanical

Connector Face: Nylon 6/6  
Molded Body: Nylon 6/6  
Contact: Gold plated Copper alloy  
Coupling Nut: Nickel plated Brass  
Grommet: Nitrile rubber  
Maximum Conductor Size: 18 AWG

### Environmental

Protection: IP67

Poles	Male		Female		Orientation	Description
	Old Part No.	Order No.	Old Part No.	Order No.		
3	7A3006-31	<a href="#">120075-0017</a>	7A3000-31	<a href="#">120075-0014</a>	Straight	With PG 7 Cable Fitting (0.13 - 0.26" O.D. [3.3-6.6mm] cable)
	7A3007-31	<a href="#">120075-0019</a>	7A3001-31	<a href="#">120075-0016</a>	90 degree	
	7A3006-32	<a href="#">120075-0018</a>	7A3000-32	<a href="#">120075-0015</a>	Straight	With PG 9 Cable Fitting (0.16 - 0.32" O.D. [4.1-8.1mm] cable)

# Brad® Micro-Change® (M12) Ultra-Lock® Sealed Distribution Box

**120119/130007/130008**

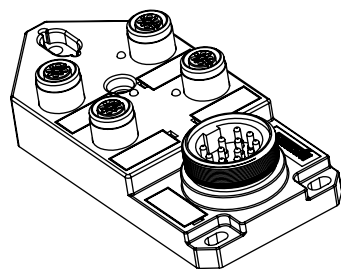

### Features and Benefits

- Available in a variety of formats for backward compatibility with different connector styles
- Accepts Ultra-Lock and threaded M12 cordsets

### Electrical

Voltage (IEC 60 664-1): 10-30V DC  
Insulation Resistance (IEC 60 512-2): >10<sup>9</sup> ohms  
Rated Current T Amb. 40C (IEC 60 512-3): 2 A per I/O  
Current: 12.0A  
Contact Resistance (IEC 60 512-2): <5 milliohms

### Mechanical

Body: PBT  
Contact Carrier: PBT  
Shell Material: Nickel over Brass  
Contact: Phosphor Bronze  
Contact Plating: Gold over Nickel  
Cable Jacket: PUR  
O-Ring: Viton

### Environmental

Pollution Degree (IEC 60 664-1): 3  
Protection: IP67/69K

Single I/O Per Port with/Integral Mini-Change Connector		
Old Part No.	Order No.	Description
BKY401P-FBB	<a href="#">120119-0002</a>	4-Port, 5-Pole/ 4 wire-single I/O per port
BKY601P-FBB	<a href="#">120119-0010</a>	6-Port, 5-Pole/ 4 wire-single I/O per port
BKY801P-FBB	<a href="#">120119-0017</a>	8-Port, 5-Pole/ 4 wire-single I/O per port

Double I/O Per Port with/Integral Mini-Change Connector		
Old Part No.	Order No.	Description
BKY403P-FBB	<a href="#">120119-0005</a>	4-Port, 5-Pole/ 5 wire-dual I/O per port
BKY603P-FBB	<a href="#">120119-0013</a>	6-Port, 5-Pole/ 5 wire-dual I/O per port
BKY803P-FBB	<a href="#">120119-0020</a>	8-Port, 5-Pole/ 5 wire-dual I/O per port

### Suggested home-run cable assembly for above junction boxes

Mini-Change® 90° Female Single-Ended Home Run Cable			
Old Part No.	Order No.	Description	Length (m)
302101A04M050	<a href="#">130008-0279</a>	18/3 22/8 PVC MI	5.0
302101A04M100	<a href="#">130008-0282</a>	18/3 22/8	10.0

### Suggested home-run cable assembly for above junction boxes

Mini-Change Female			
Old Part No.	Order No.	Description	Length (m)
208000A04M050	<a href="#">130007-0176</a>	MC 8P FP 5M 8 PVC MICRO MPIS	5.0
208000A04M100	<a href="#">130007-0177</a>	MC 8P FP 10M 8 PVC MICRO MPIS	10.0
301000A04M050	<a href="#">130008-0073</a>	MC 10P FP 5M PVC HOME RUN	5.0
301000A04M100	<a href="#">130008-0075</a>	MC 10P FP 10M PVC HOME RUN	10.0
301001A04M050	<a href="#">130008-0489</a>	MC 10P FP 90D 5M PVC HOME RUN	5.0
301001A04M100	<a href="#">130008-0112</a>	MC 10P FP 90D 10M 22/10 PVC	10.0

# Brad® Micro-Change® (M12) Sealed Distribution Box

120114

Top Mount, Single Keyway with Molded Home Run Cable

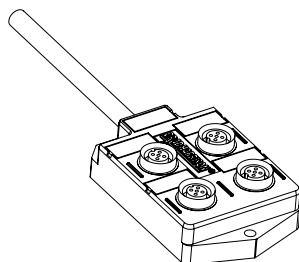

### Features and Benefits

- Simplifies wiring installation, molded PVC home run cable
- Flexibility with 4 and 8 port configurations
- PNP and NPN versions for use in a variety of DC sensors

### Reference Information

UL File No.: E46237  
CSA File No.: LR6837

### Electrical

Voltage: 10-30V DC  
Current: 4.0A per port, 12.0A max. per unit  
Indicating Lights: Green LED—power, yellow LED—function  
Average LED Expectancy: 100,000 hours

### Mechanical

Insert: PA  
Housing: Glass-filled PBT  
Receptacle Housing: Nickel-plated Brass  
ID Label: ABS  
Home Run Connector: Black, PUR cable jacket, (3) 16 AWG over either (4) or (8) 22 AWG and PVC conductor insulation over either 41 by #34 (16 AWG) or 26 by #36 (22 AWG) Copper stranding over 65 by #34 Copper stranding, 600 V  
Outside Diameter: 0.29" (7.4mm)

### Environmental

Protection: IP67

Port	Old Part No.	Order No.	Functional Wiring	Home Run Cable
4	BTY401P-FBE-05	<a href="#">120114-0021</a>	PNP	5M PVC
	BTY401P-FBE-10	<a href="#">120114-0022</a>		10M PVC
	BTY401P-FBP-05	<a href="#">120114-0024</a>	Dual-in PNP	5M PUR
	BTY405P-FBP-05	<a href="#">120114-0039</a>		5M PU
8	BTY801N-FBE-05	<a href="#">120114-0061</a>	NPN	5M PVC
	BTY801P-FBE-05	<a href="#">120114-0068</a>	PNP	5M PVC
	BTY801P-FBE-10	<a href="#">120114-0069</a>		10M PVC
	BTY801P-FBP-05	<a href="#">120114-0072</a>	Dual-in PNP	5M PUR
	BTY805P-FBP-05	<a href="#">120114-0089</a>		5M PUR

# Brad® Micro-Change® (M12) Sealed Distribution Box

120114

Top Mount, Single Keyway with Mini-Change® Home Run Connector

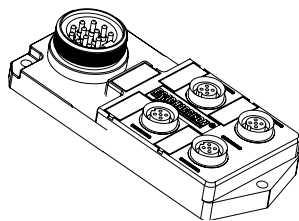

### Features and Benefits

- Connectorized home run cable connector version for maximum flexibility
- Flexibility with 4 and 8 port configurations
- PNP and NPN versions for use with a variety of DC sensors

### Reference Information

UL File No.: E46237  
CSA File No.: LR6837

### Electrical

Voltage: 10-30V DC  
Current: 4.0A per port, 12.0A total per MPIS unit  
Indicating Lights: Green LED—power, yellow LED—function  
Average LED Expectancy: 100,000 hours

### Mechanical

Insert: PA  
Housing: Glass-filled PBT  
Receptacle Housing: Nickel-plated Brass  
ID Label: ABS

### Environmental

Protection: IP67

Port	Old Part No.	Order No.	Functional Wiring
4	BTY401N-FBB	<a href="#">120114-0014</a>	PNP
	BTY401P-FBB	<a href="#">120114-0019</a>	
8	BTY801N-FBB	<a href="#">120114-0059</a>	NPN
	BTY801P-FBB	<a href="#">120114-0065</a>	

### Home Run Cables

Cable Type	Length	Old Part No.	Order No.
PVC	5m	302000A01M050	<a href="#">130008-0187</a>
	10m	302000A01M100	<a href="#">130008-0188</a>
	3 feet	302001A01F030	<a href="#">130008-0211</a>
	6 feet	302001A01F060	<a href="#">130008-0212</a>

## Brad® Micro-Change® (M12) Sealed Distribution Box

120114

Top Mount, Single Keyway  
Twin Wired with Field Attachable  
Home Run Cable

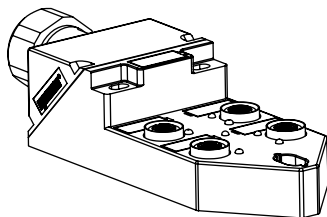

Port	Old Part No.	Order No.
4	BTY403P-FBA	<a href="#">120114-0029</a>

### Features and Benefits

- Field-attachable home run cable provides flexibility in installation
- Allows for specialty user-supplied control cable options
- User can decide home run cable lengths at last minute
- Cable can exit at either top or end of MPIS

### Electrical

Voltage: 10-30V DC  
Current: 2.0A max. per port, 12A max. per unit  
Indicating Lights: Green LED—power, yellow LED—function  
Average LED Expectancy: 100,000 hours

### Mechanical

Insert: PBT  
Housing: PBT  
Receptacle Housing: Nickel-plated Brass  
ID Label: PA  
Home Run Connector: Screw termination; maximum wire gauge 18 AWG, control cable diameter to fit PG16 grommet 0.31-0.51" (8-14mm)

### Environmental

Protection: IP67

## Brad® Micro-Change® (M12) Sealed Distribution Box

120115

Side Mount, Single Keyway with  
12" Mini-Change® Molded Home  
Run Connector

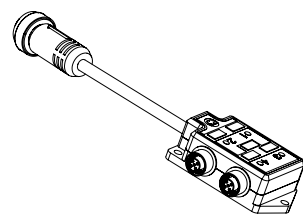

Port	Old Part No.	Order No.	Functional Wiring
4	803P402	<a href="#">120115-0047</a>	PNP
6	803P602	<a href="#">120115-0050</a>	
8	803P802	<a href="#">120115-0055</a>	

### Features and Benefits

- Molded home run connector provides flexibility
- Flexibility with 4, 6 and 8 port configurations
- PNP for use with a variety of DC sensors

### Reference Information

UL File No.: E46237  
CSA File No.: LR6837

### Electrical

Voltage: 10-30V DC  
Current: 4.0A per port, 12.0A total per MPIS unit  
Indicating Lights: Green LED—power, yellow LED—function  
Average LED Expectancy: 100,000 hours

### Mechanical

Insert: Nylon 6/6  
Housing: Nylon 6/6  
Receptacle Housing: Black E-coat  
ID Label: ABS  
Home Run Connector Cabling: Yellow, PVC cable jacket, (1) 18 AWG and either (5) or (7) 22 AWG control cabling and PVC conductor insulation over 41 by #34 (18 AWG) and 26 by #36 (22 AWG), UL listed style 2661, CSA certified 105° C, 300 V  
Outside Diameter: 0.29" (7.4mm)

### Environmental

Protection: IP67

# Brad® Micro-Change® Sealed Distribution Box

120115

## Side Mount, Single Keyway with Home Run Connector

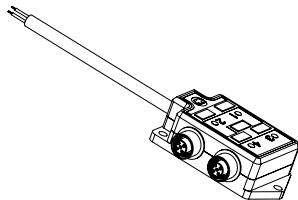

### Features and Benefits

- Simplifies wiring installation, integrated PVC home run cable
- Flexibility with 4, 6 and 8 port configurations
- PNP for use with a variety of DC sensors

### Reference Information

UL File No.: E46237  
CSA File No.: LR6837

### Electrical

Voltage: 10-30V DC  
Current: 4.0A max. per port, 12.0A total per MPIS unit  
Indicating Lights: Green LED—power, yellow LED—function  
Average LED Expectancy: 100,000 hours

### Mechanical

Insert: Nylon 6/6  
Housing: Nylon 6/6  
Receptacle Housing: Black E-coat  
ID Label: ABS  
Home Run Connector Cabling: Yellow, PVC cable jacket, (1) 18 AWG and either (5) or (7) 22 AWG control cables and PVC conductor insulation over 41 by #34 (18 AWG) and 26 by #36 (22 AWG) Copper stranding, UL listed style 2661, CSA certified 105° C, 300 V  
Outside Diameter: 0.29" (7.4mm)

### Environmental

Protection: IP67

Port	Old Part No.	Order No.	Functional Wiring	Home Run Cable
4	803P401	<a href="#">120115-0046</a>	PNP	5.0m - PVC #18 AWG
6	803P601	<a href="#">120115-0048</a>		
8	803P801	<a href="#">120115-0054</a>		

# Brad® Micro-Change® (1/2" NPT-20) Sealed Distribution Box

120115

## Side Mount, Dual Keyway Parallel Wiring with Home Run Connector

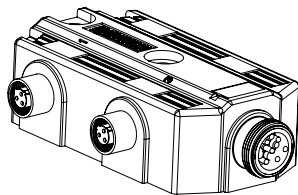

### Features and Benefits

- Connectorized home run cable connection for maximum flexibility
- Flexibility with 4 and 8 port configurations
- For use with a variety of AC sensors

### Reference Information

UL File No.: E46237  
CSA File No.: LR6837

### Electrical

Voltage: 120V AC  
Current: 4.0A per port, 12.0A total per MPIS unit

### Mechanical

Insert: Nylon 6/6  
Housing: PBT  
Receptacle Housing: Zinc die cast with black epoxy coat  
ID Label: ABS  
Home Run Connector: Yellow, ST00W PVC cable jacket, 16 AWG/6,8 and 10 conductor and PVC conductor insulation over 65 by #34 Copper stranding, UL listed ST00W 105° C, CSA certified ST 105° C, 600 V  
Outside Diameter: 4 Port—0.54" (13.7mm)  
8 Port—0.66" (16.8mm)

### Environmental

Protection: IP67

Port	Old Part No.	Order No.	Home Run Connector Style
4	702P401	<a href="#">120115-0017</a>	6P MR STD
8	702P801	<a href="#">120115-0022</a>	10P MR STD



## BradConnectivity™ mPm® Connectors

Our BradConnectivity mPm product line offers a wide range of connectors including DIN connectors, DIN splitters, molded cable connectors, suppressor adaptors, Junior Timer connectors and proximity switches for magnetic cylinders.

The mPm range of connectors is available with standard options including filament, neon or LED illuminating devices, VDR, diodes or transil diodes (with or without illuminating devices) to offer protection against overvoltage or peaks caused when switching off.

The mPm connectors are used extensively to provide electrical connections in a wide range of applications. The most common applications are in conjunction with hydraulic, pneumatic or electro magnetic devices, including solenoid valves. Other applications include pressure transducers, proximity switches, flow monitors, level sensors, limit switches, thermostats, industrial thermometers and low energy motors.

The mPm connectors are also available with approval cURus on request.

All mPm connectors offer protection from dust and water according to EN60529 (IP65 and IP67 on request) and conform to VDE 01101/89 operating voltage up to 250V group C with respect to the insulation class. The terminal block in mPm connectors is securely assembled and retained in the connector casing by way of a spring loaded lug. With this feature the terminal block remains secure in the casing reducing the danger of accidental contact or exposure to live parts even when the fixing screw is removed.

The mPm DIN connectors are designed to reduce the number of components, making them easier to assemble and with fewer parts to stock. They are supplied in single set or bulk components, eliminating the costly effort of disassembly and providing further cost savings. The new generation of mPm DIN connectors provide repeatable, unsurpassed IP67 sealing performance (even in humidity) using an external nut over the cable. The external nut accepts a wider range of cables from 4mm to 9mm, reducing the current number of different nuts from 3 (P607, P608, P611) to 1 (external nut).

Choose from the largest selection of DIN field-attachables, molded DIN and DIN accessories.

The mPm connectors with moulded cables offer a fast and efficient method of connection resulting in greatly reduced installation time and cost. They can be supplied with or without integral LED indicators and suppression circuits. A diagram is printed on each connector with circuit to allow easy user identification.

BradConnectivity mPm overmolded Junior Timer connectors are available in straight and 90 degree versions. These pre-wired overmolded connectors offer an economical alternative to hard wiring and mate with industry standard Junior Timer interfaces or solenoids and other mobile hydraulic devices and other harsh environment applications. The integrated surge suppression circuitry (VDR) protects the system and extends overall lifetime. LED indication is built into the connector head for easy identification of system status. With an IP65 environmental rating the Junior Timer provides protection in harsh and demanding environments. Plus the cable locking clip protects the connection in high vibration applications.

Also mPm offers a wide range of proximity switches. They are available with attached flying leads or a plug connector, the latter facilitating maintenance operations with all voltage disconnected. The plug connector is also available with an M12 ring nut fastener, giving enhanced security in the presence of high vibrations. The switches are impregnated with epoxy resin to give protection in accordance with IP67, excellent resistance to impact and operational temperature range of -20° to +85°C.



DIN Field Attachable



DIN Connectors



DIN Overmolded Valve Connectors



DIN Splitter

# Brad® Mini-Change® A-Size Single-Ended Cordset STOOW Cable

**130006**  
**Internal Thread**

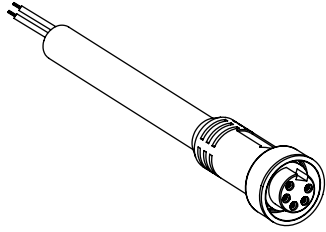

## Features and Benefits

- Patented Quad Beam contact with gold/nickel plating provides high reliability and low resistance
- Epoxy coated coupling nut is corrosion and weld slag resistant
- Cable is oil, water and UV resistant

## Reference Information

UL File No.: E152210  
CSA File No.: LR6837

## Electrical

Voltage: 600V AC/DC  
Current: 2P—13.0A  
3P—13.0A  
4P—10.0A  
5P—8.0A  
6P—8.0A

## Mechanical

Connector Face: PVC UL 94-V0  
Molded Body: PVC UL 94-V0  
Coupling Nut: Zinc diecast with black epoxy coat. Optional  
Stainless Steel type 303, type 316 or gray Nylon 6/6  
Cable: Yellow, #16 AWG, UL STOOW, CSA ST, PVC jacket and  
insulation, 65 x #34 stranding  
Cable Diameter: 2P—0.37" (9.4mm)  
3P—0.41" (10.4mm)  
4P—0.42" (10.7mm)  
5P—0.50" (12.7mm)  
6P—0.54" (13.7mm)

## Environmental

Protection: IP67

Poles	Length	Male Straight		Female Straight		Female Right Angle	
		Old Part No.	Order No.	Old Part No.	Order No.	Old Part No.	Order No.
2	3.0'	102002A01F030	<a href="#">130006-0156</a>	102000A01F030	<a href="#">130006-0088</a>	102001A01F030	<a href="#">130006-0134</a>
	6.0'	102002A01F060	<a href="#">130006-0159</a>	102000A01F060	<a href="#">130006-0091</a>	102001A01F060	<a href="#">130006-0137</a>
	12.0'	102002A01F120	<a href="#">130006-0162</a>	102000A01F120	<a href="#">130006-0096</a>	102001A01F120	<a href="#">130006-0141</a>
	20.0'	102002A01F200	<a href="#">130006-0168</a>	102000A01F200	<a href="#">130006-0102</a>	102001A01F200	<a href="#">130006-0146</a>
3	3.0'	103002A01F030	<a href="#">130006-0529</a>	103000A01F030	<a href="#">130006-0217</a>	103001A01F030	<a href="#">130006-0422</a>
	6.0'	103002A01F060	<a href="#">130006-0534</a>	103000A01F060	<a href="#">130006-0221</a>	103001A01F060	<a href="#">130006-0426</a>
	12.0'	103002A01F120	<a href="#">130006-0542</a>	103000A01F120	<a href="#">130006-0232</a>	103001A01F120	<a href="#">130006-0430</a>
	20.0'	103002A01F200	<a href="#">130006-0549</a>	103000A01F200	<a href="#">130006-0241</a>	103001A01F200	<a href="#">130006-0436</a>
4	3.0'	104002A01F030	<a href="#">130006-0991</a>	104000A01F030	<a href="#">130006-0725</a>	104001A01F030	<a href="#">130006-0898</a>
	6.0'	104002A01F060	<a href="#">130006-0995</a>	104000A01F060	<a href="#">130006-0728</a>	104001A01F060	<a href="#">130006-0902</a>
	12.0'	104002A01F120	<a href="#">130006-1002</a>	104000A01F120	<a href="#">130006-0737</a>	104001A01F120	<a href="#">130006-0905</a>
	20.0'	104002A01F200	<a href="#">130006-1009</a>	104000A01F200	<a href="#">130006-0744</a>	104001A01F200	<a href="#">130006-0912</a>
5	3.0'	105002A01F030	<a href="#">130006-1435</a>	105000A01F030	<a href="#">130006-1160</a>	105001A01F030	<a href="#">130006-1346</a>
	6.0'	105002A01F060	<a href="#">130006-1438</a>	105000A01F060	<a href="#">130006-1163</a>	105001A01F060	<a href="#">130006-1349</a>
	12.0'	105002A01F120	<a href="#">130006-1447</a>	105000A01F120	<a href="#">130006-1171</a>	105001A01F120	<a href="#">130006-1353</a>
	20.0'	105002A01F200	<a href="#">130006-1453</a>	105000A01F200	<a href="#">130006-1179</a>	105001A01F200	<a href="#">130006-1360</a>
6	3.0'	106002A01F030*	<a href="#">130006-1672*</a>	106000A01F030	<a href="#">130006-1579</a>	106001A01F030*	<a href="#">130006-1651*</a>
	6.0'	106002A01F060*	<a href="#">130006-1675*</a>	106000A01F060	<a href="#">130006-1583</a>	106001A01F060*	<a href="#">130006-1653*</a>
	12.0'	106002A01F120*	<a href="#">130006-1679*</a>	106000A01F120	<a href="#">130006-1590</a>	106001A01F120*	<a href="#">130006-1656*</a>
	20.0'	106002A01F200*	<a href="#">130006-1686*</a>	106000A01F200	<a href="#">130006-1600</a>	106001A01F200*	<a href="#">130006-1661*</a>

\*Note: This is the A-Size 6-pole Mini-Change, please refer to series 130007 for the B-Size.

# Brad® Mini-Change® A-Size Double-Ended Cordset STOOW Cable

**130011**

**Extension Cable  
Internal Thread Both Ends**

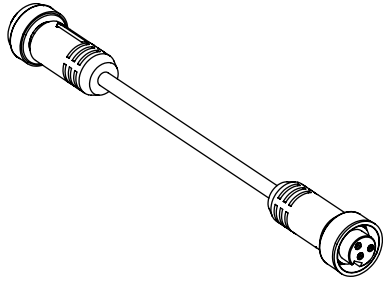

### Features and Benefits

- Patented Quad Beam contact with gold/nickel plating provides high reliability and low resistance
- Epoxy coated coupling nut is corrosion and weld slag resistant
- Cable is oil, water and UV resistant

### Reference Information

UL File No.: E1 52210

CSA File No.: LR6837

### Electrical

Voltage: 600V AC/DC

Current: 2P—13.0A

3P—13.0A

4P—10.0A

5P—8.0A

6P—8.0A

### Mechanical

Connector Face: PVC UL 94-V0

Molded Body: PVC UL 94-V0

Coupling Nut: Zinc diecast with black epoxy coat. Optional Stainless Steel type 303, type 316 or gray Nylon 6/6

Cable: Yellow, #16 AWG, UL STOOW, CSA ST, PVC jacket and insulation, 65 x #34 stranding

Cable Diameter: 2P—0.37" (9.4mm)

3P—0.41" (10.4mm)

4P—0.42" (10.7mm)

5P—0.50" (12.7mm)

6P—0.54" (13.7mm)

### Environmental

Protection: IP67

Poles	Length	Female/Male	
		Old Part No.	Order No.
2	6.0'	112020A01F060	<a href="#">130010-0147</a>
	12.0'	112020A01F120	<a href="#">130010-0152</a>
	20.0'	112020A01F200	<a href="#">130010-0159</a>
3	3.0'	113020A01F030	<a href="#">130010-0214</a>
	6.0'	113020A01F060	<a href="#">130010-0221</a>
	12.0'	113020A01F120	<a href="#">130010-0228</a>
	15.0'	113020A01F150	<a href="#">130010-0233</a>
4	20.0'	113020A01F200	<a href="#">130010-0238</a>
	3.0'	114020A01F030	<a href="#">130010-0519</a>
	6.0'	114020A01F060	<a href="#">130010-0525</a>
	12.0'	114020A01F120	<a href="#">130010-0533</a>
5	20.0'	114020A01F200	<a href="#">130010-0541</a>
	3.0'	115020A01F030	<a href="#">130010-0999</a>
	6.0'	115020A01F060	<a href="#">130010-1005</a>
	12.0'	115020A01F120	<a href="#">130010-1013</a>
6*	15.0'	115020A01F150	<a href="#">130010-1016</a>
	20.0'	115020A01F200	<a href="#">130010-1020</a>
	3.0'	116020A01F030	<a href="#">130010-1312</a>
	6.0'	116020A01F060	<a href="#">130010-1316</a>
6*	12.0'	116020A01F120	<a href="#">130010-1327</a>
	20.0'	116020A01F200	<a href="#">130010-1338</a>

\*Note: This is the A-Size 6-pole Mini-Change, please refer to series 130011 for the B-Size.

# Brad® Mini-Change® A-Size Double-Ended Cordset TPE Cable

**130010**

**Extension Cord  
Male External Thread  
Female Internal Thread**

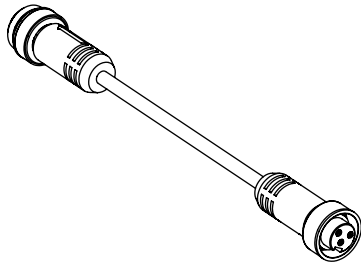

### Features and Benefits

- Patented Quad Beam contact with gold/nickel plating provides high reliability and low resistance
- Epoxy coated coupling nut is corrosion and held slag resistant
- TPE cable is weld slag and coolant resistant. It is exposed-run, tray routed and continuous flex rated.

### Reference Information

UL File No.: E152210  
CSA File No.: LR6837

### Electrical

Voltage: 600V AC/DC  
Current: 3P—13.0A  
4P—10.0A  
5P—8.0A

### Mechanical

Connector Face: PVC UL 94-V0  
Molded Body: PVC UL 94-V0  
Coupling Nut: Zinc diecast with black epoxy coat. Optional Stainless Steel type 303 or type 316  
Cable: Yellow, #16 AWG, UL type TC-ER, CSA TC, TPE jacketed, PVC/Nylon insulation, 65 x #34 stranding  
Outside Diameter: 3P—0.41" (10.4mm)  
4P—0.42" (10.7mm) .43" (10.9mm)  
5P—0.50" (12.7mm) .46" (11.7mm)

### Environmental

Protection: IP67

Poles	Length	Female/Male	
		Old Part No.	Order No.
3	1.0m	113030K13M010	<a href="#">130010-0487</a>
	2.0m	113030K13M020	<a href="#">130010-0488</a>
	3.0m	113030K13M030	<a href="#">130010-0489</a>
	4.0m	113030K13M040	<a href="#">130010-0490</a>
	5.0m	113030K13M050	<a href="#">130010-0491</a>
	6.0m	113030K13M060	<a href="#">130010-0492</a>
4	1.0m	114030K12M010	<a href="#">130010-0864</a>
	2.0m	114030K12M020	<a href="#">130010-0865</a>
	3.0m	114030K12M030	<a href="#">130010-0866</a>
	4.0m	114030K12M040	<a href="#">130010-0867</a>
	5.0m	114030K12M050	<a href="#">130010-0868</a>
	6.0m	114030K12M060	<a href="#">130010-0869</a>
5	1.0m	115030K13M010	<a href="#">130010-0102</a>
	2.0m	115030K13M020	<a href="#">130010-0103</a>
	3.0m	115030K13M030	<a href="#">130010-0104</a>
	4.0m	115030K13M040	<a href="#">130010-1750</a>
	5.0m	115030K13M050	<a href="#">130010-0105</a>
	6.0m	115030K13M060	<a href="#">130010-1758</a>

# Brad® Mini-Change® A-Size Receptacle 16 AWG

**130013/130099**  
External Thread with Leads

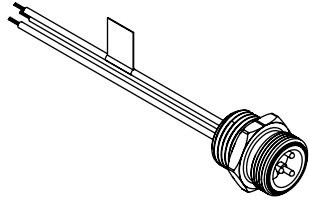

### Features and Benefits

- Patented Quad Beam contact with gold/nickel plating provides high reliability and low resistance
- Black epoxy coated Zinc diecast shell design
- #16 AWG, PVC insulated leads, U.S. color code

### Reference Information

UL File No.: E152210  
CSA File No.: LR6837

### Electrical

Voltage: 600V AC/DC  
Amperage: 2P—13.0A  
3P—13.0A  
4P—10.0A  
5P—8.0A  
6P—8.0A

### Mechanical

Shell: Zinc diecast with black epoxy coat, optional stainless steel type 303, type 316 or gray Nylon 6/6  
90°—Zinc diecast with black epoxy coat (only)  
Flange Mount—Gray anodized aluminum, optional stainless steel type 303  
Insert: PVC UL 94-V0  
Conductors: #16 AWG, PVC insulation over 26 x #30 Copper stranding, 600V, UL Style 1015, CSA TEW

### Environmental

Protection: IP67

### Accessories

Old Part No.	Order No.	Description
5601	130099-0143	Locknut 1/2" - 14NPT, Zinc plated Steel
5611	130099-0149	1/2" Gasket, black neoprene

Poles	Length	Male		Female		Orientation
		Old Part No.	Order No.	Old Part No.	Order No.	
2	12"	1R2006A20A120	<a href="#">130013-0076</a>	1R2004A20A120	<a href="#">130013-0060</a>	Straight
	6'	1R2006A20F060	<a href="#">130013-0084</a>	1R2004A20F060	<a href="#">130013-0067</a>	
	12"	1R2007A20A120	<a href="#">130013-0090</a>	1R2005A20A120	<a href="#">130013-0074</a>	
3	12"	1R3006A20A120	<a href="#">130013-0202</a>	1R3004A20A120	<a href="#">130013-0135</a>	Straight
	6'	1R3006A20F060	<a href="#">130013-0215</a>	1R3004A20F060	<a href="#">130013-0148</a>	
	12"	1R3007A20A120	<a href="#">130013-0247</a>	1R3005A20A120	<a href="#">130013-0184</a>	
4	12"	1R4006A20A120	<a href="#">130013-0353</a>	1R4004A20A120	<a href="#">130013-0314</a>	Straight
	6'	1R4006A20F060	<a href="#">130013-0361</a>	1R4004A20F060	<a href="#">130013-0325</a>	
	12"	1R4007A20A120	<a href="#">130013-0386</a>	1R4005A20A120	<a href="#">130013-0337</a>	
5	12"	1R5006A20A120	<a href="#">130013-0493</a>	1R5004A20A120	<a href="#">130013-0442</a>	Straight
	6'	1R5006A20F060	<a href="#">130013-0503</a>	1R5004A20F060	<a href="#">130013-0452</a>	
	12"	1R5007A20A120	<a href="#">130013-0534</a>	1R5005A20A120	<a href="#">130013-0482</a>	
6	12"	1R6006A20A120	<a href="#">130013-0593</a>	1R6004A20A120*	<a href="#">130013-0567*</a>	Straight
	6'	1R6006A20F060	<a href="#">130013-0605</a>	1R6004A20F060*	<a href="#">130013-0576*</a>	
	12"	1R6007A20A120	<a href="#">130013-0612</a>	1R6005A20A120*	<a href="#">130013-0589*</a>	

\*Note: This is the A-Size 6-pole Mini-Change, please refer to series 130014 for the B-Size.

# Brad® Mini-Change® A-Size Receptacle

**130013**  
With Leads

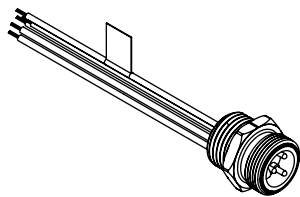

### Features and Benefits

- Patented Quad Beam contact with gold/nickel plating provides high reliability and low resistance
- Black epoxy coated Zinc diecast shell design
- #16 AWG, PVC insulated leads, U.S. color code

### Reference Information

UL File No.: E152210  
CSA File No.: LR6837

### Electrical

Voltage: 300V AC/DC  
Current: 3P—10.0A  
4P—7.0A  
5P—5.6A

### Mechanical

Shell: Zinc diecast with black epoxy coat, optional stainless steel type 303  
Insert: PVC UL 94-V0  
Conductors: #18 AWG, PVC insulation over 16 x #30 Copper stranding, 300V, UL Style 1061, CSA AWM SR

### Environmental

Protection: IP 68, NEMA 6P

AWG	Mounting Thread	Poles	Length	Male		Color Rotation
				Old Part No.	Order No.	
18	1/2" -1 NPT	3	12"	1R3006A17A120	<a href="#">130013-0193</a>	#18 Auto
		4		1R4006A16A120	<a href="#">130013-0341</a>	#18 IEC
		5		1R5006A17A120	<a href="#">130013-0489</a>	#18 Auto
16	1/2" -NPT	4		1R4006A39M020	<a href="#">1300130378</a>	#16 IEC
		3		1R3006A25A120	<a href="#">130013-0268</a>	
		4		1R4006A16A120	<a href="#">130013-0396</a>	#18 IEC
18	PG 13.5	5		1R5006A25A120	<a href="#">130013-0548</a>	

### Solder Cup Contacts

Mounting Thread	Poles	Order No.	
		Male	Female
1/2" -14 NPT	4		<a href="#">84854-9102</a>
	5	<a href="#">84854-9101</a>	<a href="#">84854-9100</a>

### Internal Thread

Poles	Length	Female		Color Rotation
		Old Part No.	Order No.	
3	2M	1R3000A20M020	<a href="#">130013-0112</a>	#16 US
4		1R4000A39M020	<a href="#">130013-0301</a>	
5		1R5000A20M020	<a href="#">130013-0426</a>	#16 IEC

# Brad® Mini-Change® B-Size Single-Ended Cordset STOOW Cable

**130007**  
Internal Thread

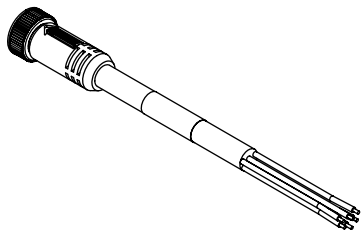

### Features and Benefits

- Patented Quad Beam contact with gold/nickel plating provides high reliability and low resistance
- Epoxy coated coupling nut is corrosion and held slag resistant
- Cable is oil, water and UV resistant

### Reference Information

UL File No.: E152210  
CSA File No.: LR6837

### Electrical

Voltage: 600V AC/DC  
Current: 6P—8.0A  
7P—8.0A  
8P—7.0A

### Mechanical

Connector Face: PVC UL 94-V0  
Molded Body: PVC UL 94-V0  
Coupling Nut: Zinc diecast with black epoxy coat, optional Stainless Steel type 303  
Cable: Yellow, #16 AWG, UL STOOW, CSA ST, PVC jacket and insulation, 65 x #34 stranding  
Outside Diameter: 6P—0.54" (13.7mm)  
7P—0.54" (13.7mm)  
8P—0.61" (15.5mm)

### Environmental

Protection: IP67

Poles	Length	Male Straight		Female Straight	
		Old Part No.	Order No.	Old Part No.	Order No.
6	3'	206002A01F030*	<a href="#">130007-0049*</a>	206000A01F030	<a href="#">130007-0022</a>
	6'	206002A01F060*	<a href="#">130007-0051*</a>	206000A01F060	<a href="#">130007-0024</a>
	12'	206002A01F120*	<a href="#">130007-0054*</a>	206000A01F120	<a href="#">130007-0026</a>
	20'	206002A01F200*	<a href="#">130007-0057*</a>	206000A01F200	<a href="#">130007-0028</a>
7	3'	207002A01F030	<a href="#">130007-0113</a>	207000A01F030	<a href="#">130007-0071</a>
	6'	207002A01F060	<a href="#">130007-0115</a>	207000A01F060	<a href="#">130007-0073</a>
	12'	207002A01F120	<a href="#">130007-0117</a>	207000A01F120	<a href="#">130007-0076</a>
	20'			207000A01F200	<a href="#">130007-0080</a>
8	3'	208002A01F030	<a href="#">130007-0197</a>	208000A01F030	<a href="#">130007-0139</a>
	6'	208002A01F060	<a href="#">130007-0199</a>	208000A01F060	<a href="#">130007-0142</a>
	12'	208002A01F120	<a href="#">130007-0202</a>	208000A01F120	<a href="#">130007-0145</a>
	20'	208002A01F200	<a href="#">130007-0204</a>	208000A01F200	<a href="#">130007-0149</a>

\*Note: This is the B-Size 6-pole Mini-Change, please refer to series 130006 for the A-Size.

# Brad® Mini-Change® B-Size Double-Ended Cordset STOOW Cable

**130011**  
Extension Cable  
Internal Thread Both Ends

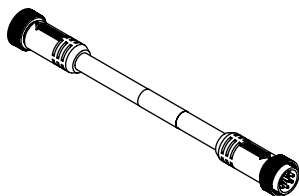

### Features and Benefits

- Patented Quad Beam contact with gold/nickel plating provides high reliability and low resistance
- Epoxy coated coupling nut is corrosion and held slag resistant
- Cable is oil, water and UV resistant

### Reference Information

UL File No.: E152210  
CSA File No.: LR6837

### Electrical

Voltage: 600V AC/DC  
Current: 6P—8.0A  
7P—8.0A  
8P—7.0A

### Mechanical

Connector Face: PVC UL 94-V0  
Molded Body: PVC UL 94-V0  
Coupling Nut: Zinc diecast with black epoxy coat, optional Stainless Steel type 303  
Cable: Yellow, #16 AWG, UL STOOW, CSA ST, PVC jacket and insulation, 65 x #34 stranding  
Outside Diameter: 6P—0.54" (13.7mm)  
7P—0.54" (13.7mm)  
8P—0.61" (15.5mm)

### Environmental

Protection: IP67

Poles	Length	Female Straight/Male Straight	
		Old Part No.	Order No.
6	6'	226020A01F060*	<a href="#">130011-0010*</a>
	12'	226020A01F120*	<a href="#">130011-0016*</a>
	20'	226020A01F200*	<a href="#">130011-0019*</a>
7	6'	227020A01F060	<a href="#">130011-0051</a>
	12'	227020A01F120	<a href="#">130011-0055</a>
	20'	227020A01F200	<a href="#">130011-0057</a>
8	6'	228020A01F060	<a href="#">130011-0119</a>
	12'	228020A01F120	<a href="#">130011-0124</a>
	20'	228020A01F200	<a href="#">130011-0130</a>

\*Note: This is the B-Size 6-pole Mini-Change, please refer to series 130006 for the A-Size.

# Brad® Mini-Change® B-Size Receptacle 16 AWG

**130014**  
External Thread

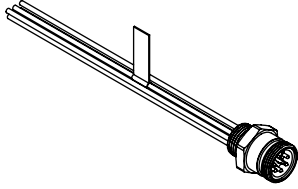

### Features and Benefits

- Patented Quad Beam contact with gold/nickel plating provides high reliability and low resistance
- Black epoxy coated Zinc diecast shell design
- #16 AWG, PVC insulated leads, U.S. color code

### Reference Information

UL File No.: E152210  
CSA File No.: LR6837

### Electrical

Voltage: 600V AC/DC  
Current: 6P—8.0A  
7P—8.0A  
8P—7.0A

### Mechanical

Shell: Zinc diecast with black epoxy coat, optional Stainless Steel type 303  
Insert: PVC UL 94-V0  
Conductors: #16 AWG, PVC insulation over 26 x #30 Copper stranding, 600V, UL Style 1015, CSA TEW

### Environmental

Protection: IP67

Poles	Lead Length	Male		Female	
		Old Part No.	Order No.	Old Part No.	Order No.
6	12"	2R6006A20A120*	<a href="#">130014-0025*</a>	2R6004A20A120	<a href="#">130014-0015</a>
	6'	2R6006A20F060*	<a href="#">130014-0032*</a>	2R6004A20F060	<a href="#">130014-0019</a>
7	12"	2R7006A20A120	<a href="#">130014-0050</a>	2R7004A20A120	<a href="#">130014-0037</a>
	6'	2R7006A20F060	<a href="#">130014-0055</a>	2R7004A20F060	<a href="#">130014-0042</a>
8	12"	2R8006A20A120	<a href="#">130014-0078</a>	2R8004A20A120	<a href="#">130014-0061</a>
	6'	2R8006A20F060	<a href="#">130014-0084</a>	2R8004A20F060	<a href="#">130014-0067</a>

\*Note: This is the B-Size 6-pole Mini-Change, please refer to series 130006 for the A-Size.

# Brad® Mini-Change® C-Size Single-Ended Cordset STOOW Cable

**130008**  
Internal Thread

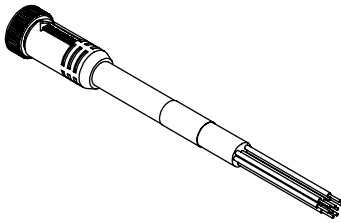

### Features and Benefits

- Patented Quad Beam contact with gold/nickel plating provides high reliability and low resistance
- Epoxy coated coupling nut is corrosion and weld slag resistant
- Cable is oil, water and UV resistant

### Reference Information

UL File No.: E152210  
CSA File No.: LR6837

### Electrical

Voltage: 600V AC/DC  
Current: 9P—7.0A  
10P—7.0A  
12P—5.0A

### Mechanical

Connector Face: PVC UL 94-V0  
Molded Body: PVC UL 94-V0  
Coupling Nut: Zinc diecast with black epoxy coat. Optional Stainless Steel type 303 or gray Nylon 6/6  
Cable: Yellow, #16 AWG, UL STOOW, CSA ST, PVC jacket and insulation, 65 x #34 stranding  
Outside Diameter: 9P—0.64" (16.3mm)  
10P—0.66" (16.8mm)  
12P—0.71" (18.0mm)

### Environmental

Protection: IP67

Poles	Length	Male Straight		Female Straight		Female Right Angle	
		Old Part No.	Order No.	Old Part No.	Order No.	Old Part No.	Order No.
9	3'	309002A01F030	<a href="#">130008-0364</a>	309000A01F030	<a href="#">130008-0323</a>		
	6'	309002A01F060	<a href="#">130008-0366</a>	309000A01F060	<a href="#">130008-0325</a>	309001A01F060	130008-0351
	12'	309002A01F120	<a href="#">130008-0368</a>	309000A01F120	<a href="#">130008-0329</a>	309001A01F120	130008-0353
	20'	309002A01F200	<a href="#">130008-0370</a>	309000A01F200	<a href="#">130008-0332</a>	309001A01F200	130008-0355
10	3'	301002A01F030	<a href="#">130008-0115</a>	301000A01F030	<a href="#">130008-0023</a>		
	6'	301002A01F060	<a href="#">130008-0117</a>	301000A01F060	<a href="#">130008-0025</a>	301001A01F060	130008-0098
	12'	301002A01F120	<a href="#">130008-0120</a>	301000A01F120	<a href="#">130008-0028</a>	301001A01F120	130008-0100
	20'	301002A01F200	<a href="#">130008-0124</a>	301000A01F200	<a href="#">130008-0033</a>	301001A01F200	130008-0104
12	3'	302002A01F030	<a href="#">130008-0229</a>	302000A01F030	<a href="#">130008-0154</a>		
	6'	302002A01F060	<a href="#">130008-0231</a>	302000A01F060	<a href="#">130008-0157</a>	302001A01F060	130008-0212
	12'	302002A01F120	<a href="#">130008-0234</a>	302000A01F120	<a href="#">130008-0161</a>	302001A01F120	130008-0215
	20'	302002A01F200	<a href="#">130008-0238</a>	302000A01F200	<a href="#">130008-0165</a>	302001A01F200	130008-0218

# Brad® Mini-Change® C-Size Double-Ended Cordset PVC Cable

**130012**  
Extension Cord  
Internal Thread Both Ends

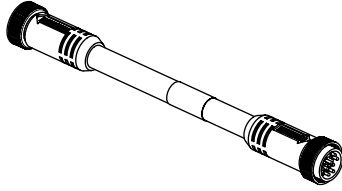

### Features and Benefits

- Patented Quad Beam contact with gold/nickel plating provides high reliability and low resistance
- Epoxy coated coupling nut is corrosion and weld slag resistant
- Cable is oil, water and UV resistant

### Reference Information

UL File No.: E152210  
CSA File No.: LR6837

### Electrical

Voltage: 600V AC/DC  
Current: 9P—7.0A  
10P—7.0A  
12P—5.0A

### Mechanical

Connector Face: PVC UL 94-V0  
Molded Body: PVC UL 94-V0  
Coupling Nut: Zinc diecast with black epoxy coat, optional Stainless Steel type 303  
Cable: Yellow, #16 AWG, UL STOOW, CSA ST, PVC jacket and insulation, 65 x #34 stranding  
Outside Diameter: 9P—0.64" (16.3mm)  
10P—0.66" (16.8mm)  
12P—0.71" (18.0mm)

### Environmental

Protection: IP67

Poles	Length	Male Straight	
		Old Part No.	Order No.
9	6'	339020A01F060	<a href="#">130012-0385</a>
	12'	339020A01F120	<a href="#">130012-0391</a>
	20'	339020A01F200	<a href="#">130012-0396</a>
10	6'	331020A01F060	<a href="#">130012-0009</a>
	12'	331020A01F120	<a href="#">130012-0016</a>
	20'	331020A01F200	<a href="#">130012-0019</a>
12	6'	332020A01F060	<a href="#">130012-0113</a>
	12'	332020A01F120	<a href="#">130012-0119</a>
	20'	332020A01F200	<a href="#">130012-0127</a>

# Brad® Mini-Change® C-Size Receptacle

**130015**  
External Thread

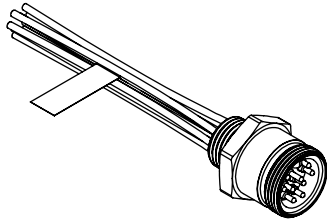

### Features and Benefits

- Patented Quad Beam contact with gold/nickel plating provides high reliability and low resistance
- Black epoxy coated Zinc diecast shell design
- #16 AWG, PVC insulated leads, U.S. color code

### Reference Information

UL File No.: E152210  
CSA File No.: LR6837

### Electrical

Voltage: 600V AC/DC  
Current: 9P—7.0A  
10P—7.0A  
12P—5.0A

### Mechanical

Shell: Zinc diecast with black epoxy coat, optional Stainless Steel type 303  
Insert: PVC UL 94-V0  
Conductors: #16 AWG, PVC insulation over 36 x #30 Copper stranding, 600V, UL Style 1015, CSA TEW

### Environmental

Protection: IP67

Mounting Thread	Poles	Length	Male Straight		Female Straight	
			Old Part No.	Order No.	Old Part No.	Order No.
½"-14 NPT	9	12"	3R9006A20A120	<a href="#">130015-0137</a>	3R9004A20A120	<a href="#">130015-0117</a>
		6'	3R9006A20F060	<a href="#">130015-0143</a>	3R9004A20F060	<a href="#">130015-0124</a>
	10	12"	3R1006A20A120	<a href="#">130015-0044</a>	3R1004A20A120	<a href="#">130015-0024</a>
		6'	3R1006A20F060	<a href="#">130015-0049</a>	3R1004A20F060	<a href="#">130015-0033</a>
	12	12"	3R2006A20A120	<a href="#">130015-0076</a>	3R2004A20A120	<a href="#">130015-0054</a>
		6'	3R2006A20F060	<a href="#">130015-0082</a>	3R2004A20F060	<a href="#">130015-0062</a>



# Brad® Mini-Change® C-Size Single and Double-Ended Cordset and Receptacle

130008/130012/130015  
19-Pole

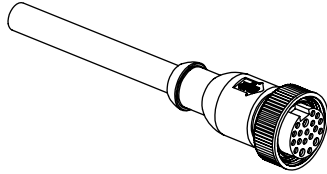

### Features and Benefits

- #18 AWG power and #22 AWG control conductors
- Oil- and abrasion-resistant black polyurethane (PUR) jacket
- Mating receptacles available in male and female designs

### Electrical

Voltage: 300V AC/DC  
Current: 3.0A—18AWG  
2.0A—22AWG

### Mechanical

Connector Face: PVC UL 94-V0  
Molded Body: PVC UL 94-V0  
Coupling Nut: Zinc diecast with black epoxy coat  
Contact: Gold plated Brass  
Cable: Black #18 AWG (.75mm<sup>2</sup>) and #22 AWG (.34mm<sup>2</sup>),  
PUR jacket and PVC conductor insulation over 42 x .15mm  
(#18) and 42 x .10mm (#22) Copper stranding  
Outside Diameter: 19P—.45" (11.4mm)  
Receptacle Shell: Gray anodized Aluminum  
Receptacle Insert: PVC UL 94-V0  
Receptacle Conductors: #22 AWG with PVC insulation  
#18 AWG with PVC insulation

### Environmental

Protection: IP67

### Single-Ended Cordset

Poles	Length	Female Straight		Female Right Angle	
		Old Part No.	Order No.	Old Part No.	Order No.
19	5M	30300P80M050	130008-0303	303001P80M050	130008-0315
	10M	30300P80M100	130008-0306	303001P80M100	130008-0316
	5M	30300B20M050	130008-0294	303001B20M050	130008-0312
	10M	30300B20M100	130008-0295	303001B20M100	130008-0313

### Double-Ended Cordset

Poles	Length	Male Straight/Female Straight	
		Old Part No.	Order No.
19	5M	333030P80M050	130012-0339
	10M	333030P80M100	130012-0341
	5M	333030B20M050	130012-0561
	10M	333030B20M100	130012-0562

### Receptacle

Poles	Length	Male		Female	
		Old Part No.	Order No.	Old Part No.	Order No.
19	0.3M	3R3N36E80C300	130015-0109	3R3N30E80C300	130015-0098
	2M	3R3N36E80M020	130015-0112	3R3N30E80M020	130015-0102

# Brad® Mini-Change® Field Attachable Connector

130017

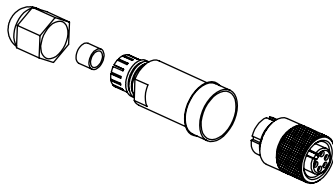

### Features and Benefits

- Allows easy field conversion to quick disconnect
- Male with internal or external threads—female with internal threads
- Secure screw terminals #15 AWG to #24 AWG—compatible with existing Mini-Change®

### Reference Information

CSA File No.: LR6837

### Electrical

Voltage: 600V AC/DC  
Current: 3P—13.0A  
4P—10.0A  
5P—8.0A

### Mechanical

Connector Face: Polyurethane  
Body: Polyamide PA6  
Contact: Gold-plated Brass  
Coupling Nut: Nickel-plated Brass or type 36 stainless steel  
Grommet: Neoprene  
Cable Range O.D.: .20" to .48" (5.0 to 12.0mm)  
Acceptable Wire Gauge Range:  
#24 AWG (.25mm<sup>2</sup>) to #15 AWG (2.0mm<sup>2</sup>)

### Environmental

Protection: IP67

Poles	Male		Female		Description
	Old Part No.	Order No.	Old Part No.	Order No.	
3	1A3002-34	130017-0008	1A3000-34	130017-0004	Straight with internal threads
	1A3002-348	130017-0009	1A3000-348	130017-0005	Stainless Steel straight with internal threads
	1A3006-34	130017-0011			Straight with external threads
	1A3006-348	130017-0012			Stainless Steel straight with external threads
4	1A4002-34	130017-0018	1A4000-34	130017-0015	Straight with internal threads
	1A4002-348	130017-0019	1A4000-348	130017-0016	Stainless Steel straight with internal threads
	1A4006-34	130017-0020			Straight with external threads
	1A4006-348	130017-0021			Stainless Steel straight with external threads
5	1A5002-34	130017-0026	1A5000-34	130017-0023	Straight with internal threads
	1A5002-348	130017-0027	1A5000-348	130017-0024	Stainless Steel straight with internal threads
	1A5006-34	130017-0029			Straight with external threads
	1A5006-348	130017-0030			Stainless Steel straight with external threads

# Brad® Mini-Change® Accessories

130006/130013/  
130018/130201

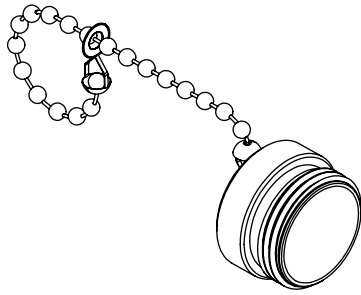

## Features and Benefits

- Closure caps for receptacles, connectors and Multi-ports
- Threaded unions for mating (2) cordsets
- Female and male plugs for liquid tight conduit terminations
- 90° adapters with (1) male and (1) female plug

## Reference Information

UL File No.: E152210\*  
CSA File No.: LR6837†

## Electrical

Liquid-tight plugs and 90° adaptors  
Voltage: 600V  
Current: 2P—13.0A  
3P—10.0A  
4P—8.0A  
5P—8.0A

## Mechanical

Closure Caps: Anodized aluminum, stainless steel or gray nylon (A-size only)  
Threaded Union: Gray anodized Aluminum  
Liquid-tight Plugs Connector Body: Zinc plated Steel  
Coupling Nut: Gray anodized Aluminum  
Clamp Nut: Zinc plated Steel  
Insert: PVC UL 94-V0  
90° Adapter Connector Body: Yellow PVC  
Coupling Nuts: Zinc diecast with black epoxy  
Insert: PVC UL 94-V0

## Environmental

Protection: IP67

## Dust Cap

Size	Poles	Plug			Receptacle		
		Old Part No.	Order No.	Description	Old Part No.	Order No.	Description
A	2-6	65-0085	<a href="#">130201-1109</a>	Black Epoxy Coat	65-0086	<a href="#">130201-1111</a>	Anodized Aluminum
		65-0085SS	<a href="#">130201-1110</a>	Stainless Steel	65-0086N	<a href="#">130201-1112</a>	Nylon
					65-0086SS	<a href="#">130201-1113</a>	Stainless Steel
B	6, 7 and 8	65-0102	<a href="#">130201-1115</a>	Anodized Aluminum	65-0103	<a href="#">130201-1116</a>	Anodized Aluminum
					65-0103SS	<a href="#">130201-1117</a>	Stainless Steel
C	9, 10 and 12	65-0104	<a href="#">130201-1118</a>	Anodized Aluminum	65-0105	<a href="#">130201-1120</a>	Anodized Aluminum
		65-0104SS	<a href="#">130201-1119</a>	Stainless Steel	65-0105SS	<a href="#">130201-1121</a>	Stainless Steel

## Threaded Unions

Old Part No.	Order No.	Description
55-0426	<a href="#">130201-1224</a>	A-Size, 2P, 6P
55-0466	<a href="#">130201-1226</a>	B-Size, 6P, 7P, 8P
55-0496	<a href="#">130201-1228</a>	C-Size, 9P, 10P, 12P

## Bulk Head Pass-Through Adapters

Old Part No.	Order No.
1R3030	<a href="#">130013-0255</a> †
1R4030	<a href="#">130013-0388</a> †
1R5030	<a href="#">130013-0541</a> †

\* UL File No.: E152210

† CSA File No.: LR6837

## Plugs

Poles	Male		Female	
	Old Part No.	Order No.	Old Part No.	Order No.
2	40780	<a href="#">130006-2098</a>	40718	<a href="#">130006-2098</a>
3	41037	<a href="#">130006-2102</a>	40925	<a href="#">130006-2099</a>
4	51149	<a href="#">130006-0184</a>	41132	<a href="#">130006-2103</a>
5	41593	<a href="#">130006-2109</a>	41344	<a href="#">130006-2107</a>

## 90° Adapters

Poles	Old Part No.	Order No.
2	40761	<a href="#">130018-0204</a>
3	41048	<a href="#">130018-0206</a>
4	41212	<a href="#">130018-0207</a>
5	41481	<a href="#">130018-0210</a>

## The Brad® Brand of Automation Products— Designed for Performance and Reliability

Molex empowers the industrial infrastructure through its Brad automation products. Brad products are ruggedly designed, engineered and constructed to provide easy installation and long-term, reliable performance in harsh environments. Whether they're for connecting power, industrial networks or automation equipment such as sensors, I/O devices, computer systems, robots, or conveyor systems, Brad products are the ideal choice for connecting the plant floor.

Brad products include:

**BradConnectivity™** connectors, cordsets and distribution boxes for sensor and actuator applications. Designed to meet our customers' requirements and built industrial-tough to ensure flexibility, interoperability and rock-solid performance. The BradConnectivity solutions include:

### Mini-Change® Connectivity

The industry's first quick-disconnect alternative to hardwiring, commonly used with 18 and 30mm proximity switches, photoelectric sensors and limit switches as well as for network I/O-power connection.

### Micro-Change® (M12) Connectivity

When space and time are in short supply, Micro-Change (M12) connectivity provides compact migration towards soft-wiring solutions. These industry standard connectors are available in single and dual keyways for a myriad of network and I/O applications.

### Nano-Change® (M8) Connectivity

The industry's broadest selection of space saving cordsets, receptacles, inserts, splitters and molded junction boxes. They provide rugged performance in tight spaces while minimizing downtime, maintenance and wiring time.

**BradCommunications™** network interface cards, gateways, diagnostic tools and Industrial Ethernet switches. Designed to enhance communication of industrial networks and devices. The BradCommunications solutions include:

Network interface cards

PC network interfaces connect "Soft" PLC, HMI/OI or SCADA applications installed on a PC based computer to an industrial network

PLC communication modules connect a PLC to an industrial network

Embedded interfaces quickly integrate an industrial network into an OEM device

Gateways connect networks to other networks or devices, exchange information across many protocols as well as creating a communications link between the plant floor and the office.

Diagnostic tools provide a clear understanding of the "health" of the network to increase production uptime as well as obtaining an early warning through its predictive technologies.

Industrial Ethernet switches intelligently route Ethernet messages, eliminate collisions and provide deterministic performance of your Ethernet network.

**BradControl™** networked I/O for on-machine applications. Designed to provide reliable connections in harsh environments between industrial controllers communicating on an industrial network and I/O devices. The BradControl solution includes:

Classic 60mm I/O modules

Compact 30mm I/O modules

**BradPower™** products bring power reliably to motors, lights, heaters and other electrical devices. The BradPower solution includes:

Cordsets, connectors, receptacles, tees and reducers that create a modular, flexible wiring system for machine power distribution and motor control

# BradPower™ Modular Power Solutions Overmolded Cordsets and Connectors



## Features and Benefits

- Available in 3 or 4 pole
- UL Listed for use in US and Canada
- IP67, IP68 and IP69K rated
- NFPA-79-2002 standard compliance
- Total installed cost can be reduced from 20 to 50% vs. conventional hard-wiring

- Modular components mean faster, easier installation and maintenance
- Eliminates the potential for mis-wiring
- Requires no tools, no pipe bending, no wire pulling, no conduit or raceways
- Complete range of modular components available for food and beverage processors

## Modular, Easy to install

BradPower solutions replace machine hard wiring with modular, quick-connect systems comprised of crush-resistant, pre-wired cordsets and factory-molded connectors. The result is a robust, scalable and easy-to-install power distribution system that does not require the specialized tools and labor typically associated with traditional conduit or raceway installations.

## Performance

BradPower wiring systems' modular components make installation faster, easier and more reliable. Where multiple machines are involved, assembling the systems is consistent and repeatable.

## Bottom-Line Benefits

Compared to traditional conduit-based hard wiring, BradPower modular solutions provide:

- Reduced labor costs
- Simplified connections
- Increased plant flexibility
- Reduced commission time

BradPower modular solutions deliver rapid return on capital equipment investments

## Markets and Applications

Robotic machinery  
Material handling equipment  
Packaging systems  
Food and beverage processing  
Factory automation  
Motor control  
Power distribution

# BradPower™ Modular Power Solutions

## Trunk/Feeder Cordsets

### Features

- 600V AC; 30.0A (3 pole) and 25.0A (4 pole)
- Dual rated 10 AWG cable
- Multiple key options available



## Drop/Branch Cordsets

### Features

- 600V AC
- 15.0A (3 pole, 14 AWG); 13.0A (3 pole, 16 AWG)
- 15.0A (4 pole, 14 AWG); 10.0A (4 pole, 16 AWG)
- Features Mini-Change® to allow for quick connection of field devices



## Tees

### Features

- 600V AC
- 30.0A (3 pole) and 25.0A (4 pole)
- Multiple key options available
- Multiple key options available
- Serve as the termination point at motors and devices



## Receptacles

### Features

- 600V AC
- 30.0A (3 pole) and 25.0A (4 pole)
- Multiple key options available
- Tees with drop connector available for access points to branch circuits to field devices
- Tees with trunk connector available to split main feeder circuit into sub-segments



## Reducers

### Features

- 600V AC
- Trunk reducer to female drop
- Reducers are essential in achieving the most versatile, scalable wiring system possible
- Multiple key options available (trunk/feeder lines)



# BradPower™ Modular Power Solutions

---

## Field Attachables

### Features

- 600V AC
- Trunk/Feeder—30.0A (3 pole); 25.0A (4 pole)
- Drop/Branch—15.0A
- Cut cable to length on-site for maximum flexibility and convenience



## Disconnect Switch

### Features

- 600V AC
- 15.0A
- Easily installed without special tools or highly skilled labor



## Accessories

### Features

- Closure caps maintain sealing integrity and provide convenient “stop points” for expandable power systems
- Locking clips snap over the outside of trunk/feeder or drop/branch connection points to limit access to the flexible wiring system



# BradConnectivity™ M23 Signal and Power Connectors

BradConnectivity M23 connectors and receptacles for signal and power applications were designed to meet our customers' stringent requirements for reliability and performance in the harshest of industrial environments.

## M23 Signal Connectors

Includes field attachable male and female cable connectors and receptacles from 6-pole to 19-pole in straight and right-angled versions. Cable connectors for a broad range of cable outer diameters and receptacles for front mounting or back mounting guarantee the highest flexibility.

### Features

- Cable assembly and shielding in one assembly step
- Clipped-on strain-relief insert prevents cable rotation
- Flexible EMC-O-Ring guarantees reliable EMC-protection
- Radial-encompassing spring contacts assure low plug-in resistance and high mating cycles
- Integrated locking clip secures the contact in the insert and allows easy assembly and disassembly



## M23 Power Connectors

For power applications up to 28 amps. Brad® offers field-attachable cable connectors and receptacles in 5+PE and 4+3+PE versions. Applying the same modular design as the signal connectors, both pole counts can be used in straight and right-angled versions.

Crimp contacts are available with different crimp ranges. Female contacts with integrated springs assure exceptional electrical performance with ultimate contact reliability in both signal and power product ranges.

*Additional tools and accessories are available, contact Molex*

### Features

- Modularity—same insert for all housings
- The integrated locking clip allows quick assembly
- Complete assembly and disassembly without special tools
- Lowest contact resistance as a result of a Gold-plated contact area
- Integrated strain-relief fitting



# DeviceNet\* IP67 I/O Module

112092

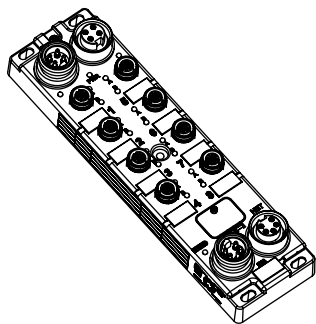

## Features and Benefits

- IP67 digital IO modules—reliable world-class product for harsh environment
- Supports ADR and Quick-Connect
- Standard mounting hole pattern allows for interchangeable with popular I/O modules
- Visible diagnostic through status LEDs for network, module, external power, inputs and outputs

## Reference Information

Approvals: ODVA, UL, CUL, CUE

## Compact

### Physical

I/O Configurations:

- 8 inputs
- 4 inputs/4 outputs

I/O Connectors:

- 4 Port—Micro-Change® 5-pole M12 female BradConnectivity™ Ultra-Lock™, internally threaded
- 8 Port—Nano-Change® 3-pole threaded M8 female

Bus Connectors:

- Network In—Micro-Change 5-pole M12 male
- Network Out—Micro-Change 5-pole M12 female

Auxiliary Power Connector:

- Power In—Micro-Change 5-pole M12 male

Address Settings: 0 to 63 using rotary switches or software

Input Type: Compatible with dry contact and PNP or NPN 3-wire switches; electronic short circuit protection.

Housing Dimensions:

30 x 175 x 20mm (1.18 x 6.89 x 0.78")

Mounting Dimensions:

- 23mm (0.91") horizontal on centers
- 168mm (6.61") vertical on centers
- Center hole

Storage Temperature: -25 to 85° C (-13 to 185° F)

RH Operating: 5 to 95% non-condensing

EMC: IEC 61000-6-2

Protection: IP67 according to IEC 60529

Vibration: IEC 60068-2-6 conformance

Shock: 10G, 11ms, 3 axis

### Electrical

External Power Requirements:

- Module and Input Power—24V DC (input devices plus module)
- Output Power—24V DC (13 to 28V), 4.0A max. per module

Baud Rate Settings: Auto baud—125, 250, 500 Kbaud

Input Delay: 3 ms

Input Device Supply: 140 mA per port at 25° C

Output Load Current:

- 1.0A max. per channel; electronic short circuit protection

Maximum Switching Frequency: 200 Hz

## Classic

### Physical

I/O Configurations:

- 16 inputs
- 8 inputs/8 outputs

I/O Connectors:

- Micro-Change® 5-pole M12 female BradConnectivity™ Ultra-Lock™, internally threaded

Bus Connectors:

- Network In—Mini-Change® 5-pole male
- Network Out—5-pole female

Auxiliary Power Connector:

- Power In—Mini-Change 4-pole male
- Power Out—4-pole female

Address Settings: 0 to 63 using rotary switches or software

Input Type:

- Compatible with dry contact and PNP or NPN 3-wire switches; electronic short circuit protection

Housing Dimensions:

60 x 220 x 20mm (2.36 x 8.66 x 0.78")

Mounting Dimensions:

- 37.5mm (1.48") horizontal on centers
- 210mm (8.27") vertical on centers Center hole

Storage Temperature: -20 to 85° C (-4 to 185° F)

RH Operating: 5 to 95% non-condensing

EMC: IEC 61000-6-2

Protection: IP67 according to IEC 60529

Vibration: IEC 60068-2-6 conformance

Shock: 10G, 11ms, 3 axis

### Electrical

External Power Requirements:

- Module and Input Power—24V DC (input devices plus module)
- Output Power—24V DC (13 to 28V), 8.0A max. per module

Baud Rate Settings: Auto baud—125, 250, 500 Kbaud

Input Device Supply: 140 mA per port at 25° C

Output Load Current: 1.0A max. per channel; electronic short circuit protection

Maximum Switching Frequency: 200 Hz

	Old Part No.	Order No.	Option	Description
Compact (30mm)	TBDDN-480N-80U	<a href="#">112092-0018</a>	8 input	DeviceNet Slave, Compact Digital, 4-port, M12 Ultra-Lock, 8 input
	TBDDN-480P-80U	<a href="#">112092-0007</a>	8 input	DeviceNet Slave, Compact Digital, 4-port, M12 Ultra-Lock, 8 input
	TBDDN-444N-88U	<a href="#">112092-5004</a>	4 input, 4 output	DeviceNet Slave, Compact Digital, 4-port, M12 Ultra-Lock, 4 input, 4 output
	TBDDN-444P-88U	<a href="#">112092-0006</a>	4 input, 4 output	DeviceNet Slave, Compact Digital, 4-port, M12 Ultra-Lock, 4 input, 4 output
	TBDDN-880N-804	<a href="#">112092-0022</a>	8 input	DeviceNet Slave, Compact Digital, 8-port, M8, 8 input
	TBDDN-880P-804	<a href="#">112092-0008</a>	8 input	DeviceNet Slave, Compact Digital, 8-port, M8, 8 input
Classic (60mm)	TCDDN-8DOP-10U	<a href="#">112092-0010</a>	16 input	DeviceNet Slave, Classic Digital, 8-port, M12 Ultra-Lock, 16 input
	TCDDN-8DON-10U	<a href="#">112092-0019</a>	16 input	DeviceNet Slave, Classic Digital, 8-port, M12 Ultra-Lock, 16 input
	TCDDN-888P-11U	<a href="#">112092-0009</a>	8 input 8 output	DeviceNet Slave, Classic Digital, 8-port, M12 Ultra-Lock, 8 input / 8 output
	TCDDN-888N-11U	<a href="#">112092-0020</a>	8 input 8 output	DeviceNet Slave, Classic Digital, 8-port, M12 Ultra-Lock, 8 input / 8 output

\* DeviceNet is a trademark of Open DeviceNet Vendor Association (ODVA)



# DeviceNet\* Micro-Change® (M12) Drop Cordset

**130027/130028**  
Single and Double-Ended

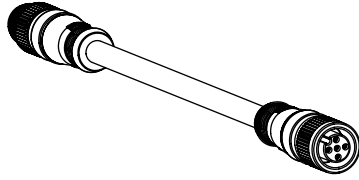

## Features and Benefits

- Rugged, IP68 rated connectors for continued connection integrity in industrial environments
- Variety of cable types, cable exit, form factor, coupling nut and length options for maximum flexibility
- Connect tees or ports on drop distribution boxes to active devices
- Micro-Change (M12) to Micro-Change (M12) cordsets or Micro-Change (M12) to Nano-Change® (M8) cordsets
- Single and double-ended
- Straight and 90°
- Standard and application-specific lengths

## Thin Standard Specifications

### Overall

Rating: 300V 80°C  
Outer Jacket: PVC  
Inner Insulation: Power—Semirigid PVC  
Data—PE foam  
Construction: Two shielded pairs, #22 Tin-Copper drain wire between pairs  
Cable Jacket Color: Gray

### Power Pair

Wire: Two #22 individually Tinned stranded Copper  
Shielding: Aluminum foil shield, 25% overlap  
DC Resistance: 16.5 ohms/1000 ft max. at 20° C max.  
Current: 4.0A  
Color Code: Red/black

### Data Pair

Wire: Two #22 individually Tinned stranded Copper  
Shielding: Aluminum foil shield, 25% overlap  
DC Resistance: 16.5 ohms/1000 ft max. at 20° C  
Velocity of Propagation: 75%  
Capacitance: 11 pF/ft  
Color Code: White/blue

### Reference Information

UL: CL2, AWM 2464  
CSA: FT4 Rated

## Thin High Flex Specifications

### Overall

Rating: 300V 80°C  
Outer Jacket: PVC  
Inner Insulation: Power—Semirigid PVC  
Data—PE foam  
Flexure: Rolling Flex > 1 million cycles at 10x bend radius  
Construction: Two foil shielded pairs, #26 Tin-Copper drains between pairs  
Cable Jacket Color: Gray

### Power Pair

Wire: Two #22 individually Tinned stranded Copper  
Shielding: Aluminum outside/polyester tape, 25% overlap  
DC Resistance: 17.5 ohms/1000 ft max. at 20° C  
Current: 4.0A max.  
Color Code: Red/black

### Data Pair

Wire: Two #24 individually Tinned stranded Copper  
Shielding: Aluminum outside/polyester tape, 25% overlap  
DC Resistance: 28 ohms/1000 ft max. at 20° C  
Velocity of Propagation: 75%  
Capacitance: 12 pF/ft  
Color Code: White/blue

### Reference Information

UL: CL3 AWM 20626, Flame UL 1581  
CSA: AWM: 1/II A/B, 80°C, 300V ft

## Thin Standard Cable

Cable Length (m)	Single-Ended						Double-Ended					
	Male Straight		Male 90°		Female 90°		Female Straight/Male Straight		Female 90°/Male Straight		Female 90°/Male 90°	
	Old Part No.	Order No.	Old Part No.	Order No.	Old Part No.	Order No.	Old Part No.	Order No.	Old Part No.	Order No.	Old Part No.	Order No.
1.0	DND02A-M010	<a href="#">130027-0012</a>	DND03A-M010	<a href="#">130027-0037</a>	DND30A-M010	<a href="#">130027-0075</a>	DND22A-M010	<a href="#">130028-0028</a>	DND32A-M010	<a href="#">130028-0085</a>	DND33A-M010	<a href="#">130028-0104</a>
3.0	DND02A-M030	<a href="#">130027-0015</a>	DND03A-M030	<a href="#">130027-0040</a>	DND30A-M030	<a href="#">130027-0077</a>	DND22A-M030	<a href="#">130028-0037</a>	DND32A-M030	<a href="#">130028-0089</a>	DND33A-M030	<a href="#">130028-0110</a>
5.0	DND02A-M050	<a href="#">130027-0017</a>	DND03A-M050	<a href="#">130027-0041</a>	DND30A-M050	<a href="#">130027-0079</a>	DND22A-M050	<a href="#">130028-0042</a>	DND32A-M050	<a href="#">130028-0091</a>	DND33A-M050	<a href="#">130028-0113</a>

## Thin High Flex

Cable Length (m)	Single-Ended						Double-Ended					
	Male Straight		Male 90°		Female 90°		Female Straight/Male Straight		Female 90°/Male Straight		Female 90°/Male 90°	
	Old Part No.	Order No.	Old Part No.	Order No.	Old Part No.	Order No.	Old Part No.	Order No.	Old Part No.	Order No.	Old Part No.	Order No.
1.0	DNDF02A-M010	<a href="#">130027-0103</a>	DNDF03A-M010	<a href="#">130027-0115</a>	DNDF30A-M010	<a href="#">130027-0161</a>	DNDF22A-M010	<a href="#">130028-0132</a>	DNDF32A-M010	<a href="#">130028-0172</a>	DNDF33A-M010	<a href="#">130028-0183</a>
3.0	DNDF02A-M030	<a href="#">130027-0159</a>	DNDF03A-M030	<a href="#">130027-0117</a>	DNDF30A-M030	<a href="#">130027-0162</a>	DNDF22A-M030	<a href="#">130028-0140</a>	DNDF32A-M030	<a href="#">130028-0244</a>	DNDF33A-M030	<a href="#">130028-0249</a>
5.0	DNDF02A-M050	<a href="#">130027-0106</a>	DNDF03A-M050	<a href="#">130027-0160</a>	DNDF30A-M050	<a href="#">130027-0130</a>	DNDF22A-M050	<a href="#">130028-0143</a>	DNDF32A-M050	<a href="#">130028-0178</a>	DNDF33A-M050	<a href="#">130028-0185</a>

\* DeviceNet is a trademark of Open DeviceNet Vendor Association (ODVA)

# DeviceNet\* Mini-Change® Trunk Cordset

## 130024/130025 Single and Double-Ended

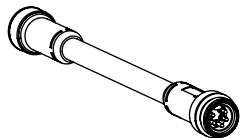

### Features and Benefits

- Plug-and-play connection between DeviceNet nodes
- Mini-Change® cordsets
- Single and double-ended
- Straight and 90°
- Standard and application-specific lengths
- Rugged, IP-68 rated connectors for continual connection integrity in industrial environments
- Phosphor-bronze contacts for greater reliability
- Variety of cable types, cable exit, coupling nut and length options for maximum flexibility

### Reference Information

UL File No.: E152210  
CSA File No.: LR6837

### Thick Standard

#### Overall

Rating: 300V, 80°C  
Outer Jacket: Gray PVC  
Outside Diameter: 0.48" (12.10mm)  
Inner Insulation:

Power—PVC with Nylon skin  
Data—PE foam

Construction: Two shielded pairs with #18 AWG (19 by #30) drain wire between pairs

### Thick Standard Cable

Cable Length (m)	Single-Ended								Double-Ended (Female/Male)					
	Male Straight		Male 90°		Female Straight		Female 90°		Straight/Straight		90°/Straight		90°/90°	
	Old Part No.	Order No.	Old Part No.	Order No.	Old Part No.	Order No.	Old Part No.	Order No.	Old Part No.	Order No.	Old Part No.	Order No.	Old Part No.	Order No.
1.0	DN01A-M010	130024-0028	DN09A-M010	130024-0059	DN10A-M010	130024-0073	DN90A-M010	130024-0133	DN11A-M010	130025-0054	DN91A-M010	130025-0173	DN99A-M010	130025-0197
3.0	DN01A-M030	130024-0032	DN09A-M030	130024-0061	DN10A-M030	130024-0078	DN90A-M030	130024-0136	DN11A-M030	130025-0067	DN91A-M030	130025-0177	DN99A-M030	130025-0200
5.0	DN01A-M050	130024-0034	DN09A-M050	130024-0064	DN10A-M050	130024-0080	DN90A-M050	130024-0137	DN11A-M050	130025-0073	DN91A-M050	130025-0179	DN99A-M050	130025-0202

### Thick Flex-Rated Cable

Cable Length (m)	Single-Ended								Double-Ended (Female/Male)					
	Male Straight		Male 90°		Female Straight		Female 90°		Straight/Straight		90°/Straight		90°/90°	
	Old Part No.	Order No.	Old Part No.	Order No.	Old Part No.	Order No.	Old Part No.	Order No.	Old Part No.	Order No.	Old Part No.	Order No.	Old Part No.	Order No.
1.0	DNF01A-M010	130024-0265	DNF09A-M010	130025-0538	DNF10A-M010	130024-0337	DNF90A-M010	130024-0341	DNF11A-M010	130025-0408	DNF91A-M010	130025-0468	DNF99A-M010	130025-0482
3.0	DNF01A-M030	130024-0267	DNF09A-M030	130025-0539	DNF10A-M030	130024-0338	DNF90A-M030	130024-0342	DNF11A-M030	130025-0412	DNF91A-M030	130025-0470	DNF99A-M030	130025-0542
5.0	DNF01A-M050	130024-0269	DNF09A-M050	130025-0540	DNF10A-M050	130024-0287	DNF90A-M050	130024-0343	DNF11A-M050	130025-0415	DNF91A-M050	130025-0472	DNF99A-M050	130025-0486

### Mid Cable

Cable Length (m)	Single-Ended								Double-Ended (Female/Male)					
	Male Straight		Male 90°		Female Straight		Female 90°		Straight/Straight		90°/Straight		90°/90°	
	Old Part No.	Order No.	Old Part No.	Order No.	Old Part No.	Order No.	Old Part No.	Order No.	Old Part No.	Order No.	Old Part No.	Order No.	Old Part No.	Order No.
1.0	DNB01A-M010	130024-0146	DNB09A-M010	130024-0163	DNB10A-M010	130024-0169	DNB90A-M010	130024-0178	DNB11A-M010	130025-0233	DNB91A-M010	130025-0259	DNB99A-M010	130025-0267
3.0	DNB01A-M030	130025-0292	DNB09A-M030	130024-0336	DNB10A-M030	130024-0339	DNB90A-M030	130024-0344	DNB11A-M030	130025-0235	DNB91A-M030	130025-0541	DNB99A-M030	130025-0270
5.0	DNB01A-M050	130024-0151	DNB09A-M050	130024-0165	DNB10A-M050	130024-0340	DNB90A-M050	130024-0180	DNB11A-M050	130025-0237	DNB91A-M050	130025-0261	DNB99A-M050	130025-0271

### Thin Standard Cable

Cable Length (m)	Double-Ended					
	Female Straight/Male Straight		Female 90°/Male Straight		Female 90°/Male 90°	
	Old Part No.	Order No.	Old Part No.	Order No.	Old Part No.	Order No.
1.0	DND11A-M010	130025-0287	DND91A-M010	130025-0322	DND99A-M010	130025-0543
3.0	DND11A-M030	130025-0292	DND91A-M030	130025-0324	DND99A-M030	130025-0544
5.0	DND11A-M050	130025-0295	DND91A-M050	130025-0326	DND99A-M050	130025-0545

### Thin High Flex Cable

Cable Length (m)	Double-Ended					
	Female Straight/Male Straight		Female 90°/Male Straight		Female 90°/Male 90°	
	Old Part No.	Order No.	Old Part No.	Order No.	Old Part No.	Order No.
1.0	DNDF11A-M010	130025-0502	DNDF91A-M010	130025-0546	DNDF99A-M010	130025-0513
3.0	DNDF11A-M030	130025-0504	DNDF91A-M030	130025-0547	DNDF99A-M030	130025-0333
5.0	DNDF11A-M050	130025-0508	DNDF91A-M050	130025-0548	DNDF99A-M050	130025-0515

\* DeviceNet is a trademark of Open DeviceNet Vendor Association (ODVA)

# DeviceNet\* Receptacle

120070/130031/  
130039/130188

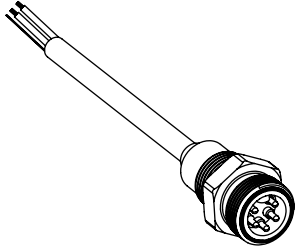

## Features and Benefits

- Connects the external trunk line with an enclosure
- Mini-Change® receptacles with DeviceNet color rotation
- Male and female
- Front-Panel mount
- Bulkhead feed-through
- PCB-mount or cable lead
- A variety of options allows for maximum flexibility in connecting devices nodes
- Bulkhead version features rugged keyways for positive alignment of connections

## Thick Media

### Electrical

Voltage: 300V AC/DC  
Current: Based on cable used

### Mechanical

Shell (Receptacle): Gray anodized Aluminum  
Shell (Bulkhead) Nickel-Brass  
Gasket Material (Bulkhead): Neoprene  
Thrust Washer (Bulkhead): Nylon  
Locknut Material (Bulkhead): Brass alloy  
Insert: PVC UL 94V  
Outside Diameter: Thick—0.48" (12.10mm)  
Mid—0.34" (8.60mm)  
Thick-Flex—0.48" (12.20mm)

### Environmental

Protection: IP67

## Thin Media

### Reference Information

(Except for Bulkhead)  
UL File No.: E152210  
CSA File No.: LR6837

### Electrical

Voltage Rating: 250V AC/DC  
Current: 4.0A

### Mechanical

Shell: Receptacle—Anodized Aluminum  
Bulkhead—Nickel over Brass  
PCB—Thermoplastic  
Insert: Nylon 6/6  
Coupling Nut: PCB—Delrin  
Gasket Material: Bulkhead—Neoprene  
Lock Washer: Bulkhead—Steel Alloy  
Support Bracket: Steel, Tin, Lead, coated  
MB Panel Thickness: PCB—0.639 to 0.070"

### Environmental

Protection: Receptacles—IP67  
Bulkhead—PCB IP67

## Drop Receptacle Micro-Change (M12)

PCB Mount								12" Wire Pigtail			
Male Straight		Male 90°		Female Straight		Female 90°		Male Straight		Female Straight	
Old Part No.	Order No.	Old Part No.	Order No.	Old Part No.	Order No.	Old Part No.	Order No.	Old Part No.	Order No.	Old Part No.	Order No.
8R5L560005-35	<a href="#">120070-0243</a>	8R5L570005-35	<a href="#">120070-0245</a>	8R5L500005-35	<a href="#">120070-0239</a>	8R5L510005-35	<a href="#">120070-0241</a>	81612	<a href="#">130031-0026</a>	81611	<a href="#">130031-0023</a>

## Trunk Receptacle—Front Panel Mount with Cable

Mounting Thread	Cable Length (m)	Description	Male Straight		Female Straight	
			Old Part No.	Order No.	Old Part No.	Order No.
1/2" - 14 NPT	0.50	Thick Standard Cable	DN5100-M005	<a href="#">130039-0297</a>	DN5000-M005	<a href="#">130039-0283</a>
	1.0		DN5100-M010	<a href="#">130039-0299</a>	DN5000-M010	<a href="#">130039-0284</a>
	0.50	Mid Cable	DNB5100-M005	<a href="#">130039-0317</a>	DNB5000-M005	<a href="#">130039-0311</a>
	1.0		DNB5100-M010	<a href="#">130039-0318</a>	DNB5000-M010	<a href="#">130039-0312</a>

## Trunk Receptacle—Double-Ended Back Panel Mount to Mini-Change Receptacle (Female/Male)

Mounting Thread	Cable Length (m)	Description	Receptacle/Straight		Receptacle/90°		Straight/Receptacle	
			Old Part No.	Order No.	Old Part No.	Order No.	Old Part No.	Order No.
1/2" - 14 NPT	1.0	Thick Standard Cable	DN5210A-M010	<a href="#">130039-0096</a>	DN5290A-M010	<a href="#">130039-0098</a>	DN5301A-M010	<a href="#">130039-0101</a>

Mounting Thread	PCB Mount				Bulkhead Feed-Through	
	Male Straight		Female Straight		Male Straight	Female Straight
	Old Part No.	Order No.	Old Part No.	Order No.	Old Part No.	Order No.
1/2" - 14 NPT	67-0065	<a href="#">130188-0033</a>	67-0075	<a href="#">130188-0034</a>	1R5030	<a href="#">130013-0541</a>

\* DeviceNet is a trademark of Open DeviceNet Vendor Association (ODVA)

# DeviceNet\* Sealed Distribution Box

130036/130037/130039

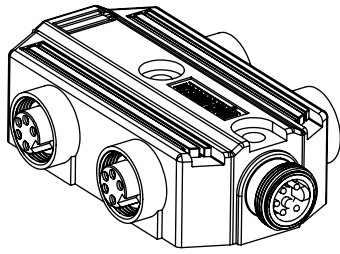

### Features and Benefits

- Allows several trunk cables or drop cables with Mini-Change® style of connectors to be consolidated and can be connected to the trunk
- Eliminate the need to have numerous tees connected near a single point
- Rugged enclosure for reliable connectors in industrial environment

### Thin Media

#### Reference Information

cCSAus File No.: LR6837

#### Electrical

Voltage: 120V AC/DC

Amperage: 7.0A total per unit

#### Mechanical

Insert: PVC

Housing: Zinc diecast with black epoxy coat

ID Label: ABS

#### Environmental

Protection: IP67

### Thick Media

#### Reference Information

UL File No.: E46237

CSA File No.: LR6837

#### Electrical

Voltage: 120V AC/DC

Amperage: 7.0A total per unit

#### Mechanical

Insert: PVC

Housing: PET (Polyester)

Receptacle Housing: Zinc diecast with black epoxy coat

ID Label: ABS

#### Environmental

Protection: IP67

Mounting	Ports	Thick Media				Thin Media			
		Mini-Change BUS IN with Mini Ports		Mini-Change BUS IN/BUS OUT with Mini Ports		Mini-Change BUS IN with Mini Ports		Mini-Change BUS IN/BUS OUT with Mini Ports	
		Old Part No.	Order No.	Old Part No.	Order No.	Old Part No.	Order No.	Old Part No.	Order No.
Side	2			DN2100	<a href="#">130039-0336</a>				
	4	DN4000	<a href="#">130036-0005</a>	DN4100	<a href="#">130036-0006</a>	DND4000	<a href="#">130036-0011</a>	DND4100	<a href="#">130036-0012</a>
	6	DN6000	<a href="#">130036-0008</a>	DN6100	<a href="#">130036-0009</a>	DND6000	<a href="#">130036-0014</a>	DND6100	<a href="#">130036-0015</a>

Mounting	Ports	Thick Media					
		Mini-Change BUS IN with Micro Ports		Mini-Change BUS IN with 2 Meter Cable with Micro Ports		Mini-Change BUS IN/BUS OUT with 2 Meter Cable with Micro Ports	
		Old Part No.	Order No.	Old Part No.	Order No.	Old Part No.	Order No.
Top	4	DND4200	<a href="#">130037-0004</a>	DND4500-02	<a href="#">130037-0006</a>	DND4300-02	<a href="#">130037-0005</a>

# DeviceNet\* Tee and Splitter

130035/130039

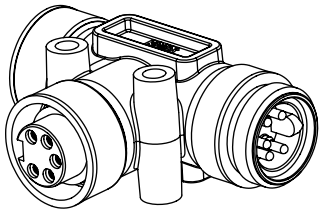

### Features and Benefits

- Phosphor bronze contacts for greatest reliability
- Variety of Mini-Change® to Micro-Change® (M12) cordset configurations for installation flexibility
- Tees enable tapping into trunk line to add drop lines or devices
- Splitters allow service to two devices through just one connection
- Power monitor tees show you what the power condition is, when an improper condition occurred and what that condition is.

### Tee

#### Electrical

Voltage: 50V  
Current: Mini-Change drop—8.0A  
Micro-Change drop—3.0A  
Contact Material: Phosphor Bronze Alloy  
Contact Plating: Gold over Nickel Alloy

#### Mechanical

Connector Face: Mini-Change Drop Tee—TPE  
Micro-Change Drop Tee—PCV  
Molded Body: Mini-Change Drop Tee—TPE  
Micro-Change Drop Tee—PCV  
Coupling Nut: Zinc diecast black E-Coat  
MICT555—Nickel-plated Brass

#### Environmental

Protection: Mini-Change—IP67  
Micro-Change—IP67

### Splitter

#### Reference Information

UL File No.: E152210  
CSA File No.: LR6337

#### Electrical

Voltage: Micro-Change—250V AC/DC  
Mini-Change—600V AC/DC  
Current: Micro-Change—4.0A  
Mini-Change—10A

#### Mechanical

Connector Face: Micro-Change—Nylon 6/6  
Mini-Change—PVC  
Molded Body: PVC  
Coupling Nut: Zinc diecast with black epoxy coat, optional stainless Steel type 303 Nickel-plated Brass  
Outside Diameter: Thin—0.27" (6.9mm)  
Thin-Flex—0.30" (12.2mm)

#### Environmental

Protection: IP67

### Tee

Configuration	Standard Bus Drop with Power Diagnostics		Bus Drop Wye		Mini-Change Drop		Bus Drop Micro		Micro-Bus Drop	
	Old Part No.	Order No.	Old Part No.	Order No.	Old Part No.	Order No.	Old Part No.	Order No.	Old Part No.	Order No.
	Right	DN3020-PM-1	<a href="#">130035-0061</a>	DN3200	<a href="#">130035-0071</a>	DN3020	<a href="#">130035-0057</a>			MICT555
Back							DND3020	<a href="#">130039-0341</a>		
Left	DN3020-PM-3	<a href="#">130035-0060</a>								

### Splitter

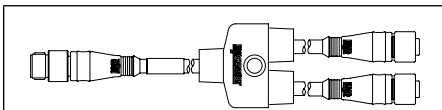

Male-Female/Female	
Old Part No.	Order No.
DNYG001	130039-0396

### Tee Gender Configuration Chart

Old Part No.	Order No.	Left Trunk Connection	Right Trunk Connection	Drop Connection
DN3020PM-1	<a href="#">130035-0060</a>	Male	Female	Female
DN3020PM-3	<a href="#">130035-0061</a>	Female	Male	
DN3200	<a href="#">130035-0071</a>			
DND3020	<a href="#">130035-0057</a>			
MICT555	<a href="#">130035-0090</a>			

\* DeviceNet is a trademark of Open DeviceNet Vendor Association (ODVA)

# DeviceNet\* Trunk Gender Changer

**130035/130039**  
**Mini-Change® Connection**

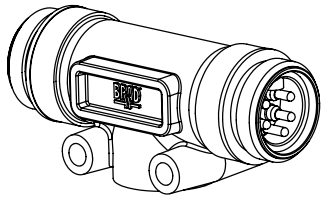

### Features and Benefits

- Phosphor bronze contacts for greatest reliability
- Change connection interface from male to female or vice-versa
- Female-to-Male, Straight or 90° versions
- Right angle version specially designed for tight spaces

### Electrical

Voltage: 50V  
Current: 8.0A  
Contact Material: Phosphor Bronze alloy  
Contact Plating: Gold over Nickel

### Mechanical

Connector Face: Thermoplastic Elastomer  
Molded Body: Thermoplastic Elastomer  
Coupling Nut: Zinc diecast, black E-Coat—Stainless Steel, Nickel-plated Brass optional

### Environmental

Protection: IP67

Male Straight/Male		Female Straight/Female		Female/Male 90°	
Old Part No.	Order No.	Old Part No.	Order No.	Old Part No.	Order No.
115060A	<a href="#">130035-0015</a>	115010A	<a href="#">130039-0351</a>	115032A	<a href="#">130035-0013</a>

\* DeviceNet is a trademark of Open DeviceNet Vendor Association (ODVA)

# DeviceNet\* Termination Resistor

**130039**

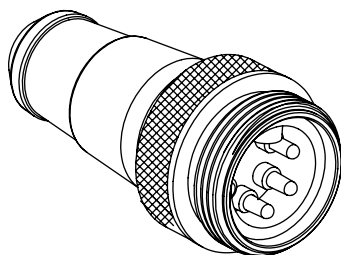

### Features and Benefits

- Phosphor bronze contacts for greatest reliability
- Diagnostics versions indicate power connection and correct polarity
- Used to terminate end of data line
- Trunk and drop versions
- LED diagnostic versions

### Electrical

Voltage: 50V  
Current: Mini-Change®—8.0A  
Micro-Change®—4.0A  
Contact Material: Phosphor Bronze Alloy  
Contact Plating: Gold over Copper Alloy  
LED: Green—Proper polarity  
Red—Improper polarity

### Mechanical

Connector Face: Mini-Change: PVC  
Micro-Change: Nylon  
Molded Body: Diagnostic—Clear PVC  
Standard—Gray PVC  
Coupling Nut: Zinc diecast, black E-Coat optional  
302 stainless

### Environmental

Protection: IP67

Option	Trunk (Mini-Change Connection)				Drop (Micro-Change (M12) Connection)			
	Male		Female		Male		Female	
	Old Part No.	Order No.	Old Part No.	Order No.	Old Part No.	Order No.	Old Part No.	Order No.
Standard	DN100	<a href="#">130039-0370</a>	DN150	<a href="#">130039-0376</a>	DND100	<a href="#">130039-0382</a>	DND150	<a href="#">130039-0385</a>
with LED	DN100L	<a href="#">130039-0371</a>	DN150L	<a href="#">130039-0072</a>				
Jumpered					DND101	<a href="#">130039-0125</a>	DND151	<a href="#">130039-0386</a>

Bus Extender	
Old Part No.	Order No.
DNTEXT-C	<a href="#">130039-0389</a>

\* DeviceNet is a trademark of Open DeviceNet Vendor Association (ODVA)

# DeviceNet\* Mini-Change® and Micro-Change® (M12) Field Attachable Connector

130034

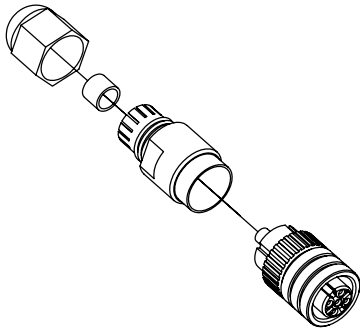

### Features and Benefits

- Accepts a wide range of DeviceNet cables for maximum installation flexibility
- Field termination for specific length or repair
- Internal and external threads
- Color-coded screw terminators make for error free field installation

### Mini-Change® DeviceNet Field Attachable

#### Reference Information

CSA File No.: LR6837

#### Electrical

Voltage: 600V AC/DC

Current: 8.0A

#### Mechanical

Connector Face: Polyurethane

Connector Body: Polyamide Pag

Contact: Gold-plated Brass

Coupling Nut: Nickel-plated Brass

Grommet: Neoprene

Cable Range OD: 0.20-0.48" (5.0-12.0mm)

Acceptable Cable Types: Thick, thin, mid

Acceptable Wire Gauges: #24 AWG (0.25mm<sup>2</sup>) to #15 AWG (2.0mm<sup>2</sup>)

Color Coding: Per ODVA Standards

#### Environmental

Protection: IP67

### Micro-Change® (M12) DeviceNet Field Attachable

#### Reference Information

CSA File No.: LR6835

#### Electrical

Voltage Rating: 36V DC

Current: 4.0A

#### Mechanical

Connector Face: Polyamide

Molded Body: Polyamide

Contact: Silver-plated Brass

Coupling Nut: Nickel-plated Brass

Grommet: Nitrite rubber

Cable Range OD: 0.16 to 32" OD (4.1 to 8.1mm)

Acceptable Cable Types: Thin, Thin-Flex, Thin-600V

Color Coding: Per DNET standards

#### Environmental

Protection: IP67

Trunk (Mini-Change® Connection)				Drop (Micro-Change® (M12) Connection)			
Female Straight		Male Straight		Female Straight		Male Straight	
Old Part No.	Order No.	Old Part No.	Order No.	Old Part No.	Order No.	Old Part No.	Order No.
1A5000-34DN	<a href="#">130034-0005</a>	1A5006-34DN	<a href="#">130034-0006</a>	8A5000-32DN	<a href="#">130034-0007</a>	8A5006-32DN	<a href="#">130034-0008</a>

\* DeviceNet is a trademark of Open DeviceNet Vendor Association (ODVA)

# PROFIBUS I/O Module

112038

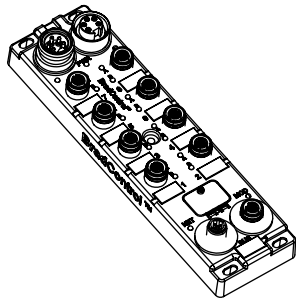

## Features and Benefits

- Accepts both M12 threaded and Ultra-Lock®
- Compact
  - 30mm wide package size
  - 4 ports, M12 Ultra-Lock technology
  - Speed: 9.6 Kbps to 12 Mbps
  - Slave DP-VO
- Classic
  - 60mm wide package size
  - 8 ports, M12 Ultra-Lock technology
  - Speed: 9.6 Kbps to 12 Mbps
  - Slave DP-VO

## Reference

EMC: IEC 61000-6-2  
 Protection: IEC IP67 according to IEC 60529  
 Vibration: IEC 60068-2-6 conformance  
 Approvals: CE, UL, CUL and PNO certification

## Compact

### Physical

I/O Configurations:

- 8 input
- 4 inputs/4 outputs
- 8 outputs
- 6 inputs/2 outputs

I/O Connectors:

- 5-pole female M12 BradConnectivity™ Ultra-Lock or 3-pole female threaded M8 connectors

Bus Connectors:

- Bus in: Male reverse keyway M12 5-pole, B-coded
- Bus out: Female reverse keyway M12 5-pole, B-coded BradConnectivity Ultra-Lock

## Compact Threaded and Ultra-Lock (M12) Connection

Ports	Old Part No.	Order No.	Input Interface	Description
4	TBDPB-480N-B8U	<a href="#">112038-0009</a>	NPN	8 input
	TBDPB-480P-B8U	<a href="#">112038-0011</a>	PNP	
	TBDPB-462N-B8U	<a href="#">112038-0007</a>	NPN	6 input/2 output
	TBDPB-462P-B8U	<a href="#">112038-0008</a>	PNP	
	TBDPB-444N-B8U	<a href="#">112038-0005</a>	NPN	4 input/4 output
	TBDPB-444P-B8U	<a href="#">112038-0006</a>	PNP	
	TBDPB-408P-B8U	<a href="#">112038-0003</a>	PNP	8 output

## Compact Threaded and Ultra-Lock (M8) Connection

Ports	Old Part No.	Order No.	Input Interface	Description
8	TBDPB-880N-B84	<a href="#">112038-0019</a>	NPN	8 input
	TBDPB-880P-B84	<a href="#">112038-0021</a>	PNP	
	TBDPB-862N-B84	<a href="#">112038-0017</a>	NPN	6 input/2 output
	TBDPB-862P-B84	<a href="#">112038-0018</a>	PNP	
	TBDPB-844N-B84	<a href="#">112038-0015</a>	NPN	4 input/4 output
	TBDPB-844P-B84	<a href="#">112038-0016</a>	PNP	
	TBDPB-808P-B84	<a href="#">112038-0014</a>	PNP	8 output

Power Connectors:

- Power in: Male Micro-Change® M12 5-pole
- Address Settings:
  - 1-99 by rotary switches;
  - 1-126 by set\_slave\_address command

Input Type:

- Dry contact, PNP or NPN
- Housing Dimensions:
  - 30 x 175 x 20mm (1.18 x 6.89 x 0.78")
- Mounting Dimensions:
  - 23mm (0.91") horizontal on centers,
  - 168mm (6.61") vertical centers

Storage Temperature: -25 to 90° C (-13 to 194° F)

RH Operating: 5 to 95% non-condensing

Shock: 10G, 11ms, 3 axis

## Electrical

External Power Requirements:

- Module and input power: 24V DC, device current and module Output power: 24V DC (13 to 28V), 4.0A max. per module
- Baud Rate Settings: Auto baud, all Profibus® baud rates up to 12 Mbaud
- Input Delay: 3ms
- Input Device Supply: 140mA per port at 25° C
- Output Load Current:
  - Sourcing, 1.4A per channel max., 4.0A per module max.
  - Input Signal Voltage: "0": -2 to 7V/ "1": 9 to 30V
  - Output Voltage: Auxiliary power value: 1V

## Classic

### Physical

I/O Configurations:

- 16 inputs
- 12 inputs/4 outputs
- 14 inputs/2 outputs
- 8 inputs/8 outputs
- 5-pole female M12 BradConnectivity Ultra-Lock allows 2 input or 2 output channels per connector

Bus Connectors:

- Bus in: Male reverse-key M12 5-pole, B-coded
- Bus out: Female reverse-key M12 5-pole, B-coded

Power Connectors:

- Power in: Male Mini-Change® 5-pole
- Power out: Female Mini-Change 5-pole

Address Settings:

- 1-99 by rotary switches (0 = factory default of 126);
- 1-126 by set\_slave\_address command

Input Type:

- Compatible with dry contact and PNP or NPN 3-wire switches; electronic short circuit protection
- Housing Dimensions:
  - 60 x 220 x 20mm (2.36 x 8.66 x 0.78")
- Mounting Dimensions:
  - 37.5mm (1.48") horizontal on centers,
  - 210mm (8.27") vertical on centers

## Mechanical

Maximum Switching Frequency: 200 Hz

## Electrical

External Power Requirements:

- Module and input power: 24V DC, device current and module
- Output power: 24V DC (13 to 28V), 8.0A max. per module
- Baud Rate Settings: Auto baud, all Profibus® baud rates up to 12 Mbaud
- Input Delay: 3ms
- Input Device Supply: 140mA per port at 25° C
- Output Load Current:
  - 2.0A per channel max., electronic short circuit protection
  - Input Signal Voltage: "0": -2 to 5V/ "1": 10 to 28V
  - Output Voltage: Supply value less 1V

## LED Indicators

### Electrical

Output Power (O):

- Green—External supply present

Input/Output:

- Compact—4 port: 1A to 4B
  - 8 port: 1 to 8
  - Green: input/output on
  - Red: input/output fault
- Classic—M12: 1A to 8B
  - Green: input/output on
  - Red: input/output fault

## Physical

Profibus Network Status (NET):

- Green—Running
- Red—Device not configured

I/O Module Diagnostics:

- Off—No fault
- Red—Fault

Module and Input Power (I):

- Green—External supply present

## Classic Threaded and Ultra-Lock (M12) Connection

Ports	Old Part No.	Order No.	Input Interface	Description
8	TCDPB-8D0N-B1U	<a href="#">112038-0030</a>	NPN	16 input
	TCDPB-8D0P-B1U	<a href="#">112038-0031</a>	PNP	
	TCDPB-8C2N-B1U	<a href="#">112038-0028</a>	NPN	14 input/2 output
	TCDPB-8C2P-B1U	<a href="#">112038-0029</a>	PNP	
	TCDPB-8B4N-B1U	<a href="#">112038-0026</a>	NPN	12 input/4 output
	TCDPB-8B4P-B1U	<a href="#">112038-0027</a>	PNP	
	TCDPB-888N-B1U	<a href="#">112038-0024</a>	NPN	8 input/8 output
	TCDPB-888P-B1U	<a href="#">112038-0025</a>	PNP	



# PROFIBUS Double-Ended and D-Sub Cordset

120098

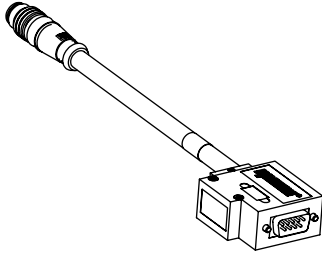

## Features and Benefits (Double-Ended Cordset)

- Double ended straight and 90°
- Used in a variety of configurations where a complete daisy-chain plug-and-play solution is desired

## Features and Benefits (D-Sub Cordset)

- Shielded D-Sub connector maintains signal integrity in noisy environments
- D-Sub includes termination switch for field installation flexibility
- Plug and play connection between PROFIBUS interface cards and modules
- D-Sub to single or dual ended M12
- Horizontal, vertical, straight or 90° configurations
- Standard and application specific lengths

## Physical

### Micro-Change Connector

Connector Face: Nylon 6/6

Molded Body: PUR

Coupling Nut: Nickel-plated Brass (360° Shielded)

### 9-pin D-Sub Connector

Material: ABS

## Environmental

### Micro-Change Connector

Protection: IP67, NEMA 6

### 9-pin D-Sub Connector

Protection: IP40

## Cable

Outside Diameter: 8 ± 0.2mm

### Cable Construction

Jacket Material: PUR

Inner Material Insulation: PE insulation

Shield Type: PETP/AV foil, Tinned Copper braid 65%

Conductor: Twisted pair 24 AWG

### Cable Flex Information

Torsion: Survived more than 2 million cycles at 360° over 1m

C-Track: Survived more than 3 million cycles at acceleration of 10m/s<sup>2</sup> and process speed of 5m/s

Bend Radius: 7.5 x cable diameter (static)

## Electrical

Voltage: 250V AC/DC

Current: 4A

## D-Sub (9-pin) to D-Sub (9-pin)

Configuration	Horizontal		Vertical		Single-Ended	
	Old Part Number	Order Number	Old Part Number	Order Number	Old Part Number	Order Number
Horizontal	MM3S60PP4M010	<a href="#">120098-0198</a>	MM3S62PP4M010	<a href="#">120098-0200</a>	MO3S06PP4M010	<a href="#">120098-0202</a>
	MM3S60PP4M050	<a href="#">120098-0118</a>	MM3S62PP4M050	<a href="#">120098-0201</a>	MO3S06PP4M050	<a href="#">120098-0124</a>
Vertical	MP3S62PP4M010	<a href="#">120098-0199</a>				
	MP3S62PP4M050	<a href="#">120098-0153</a>				
Vertical with Programming Port					P03S07PP4M010	<a href="#">120098-0203</a>
					P03S07PP4M050	<a href="#">120098-0224</a>

## D-Sub (9-pin) to Dual D-Sub (9-pin)

Configuration	Horizontal		Vertical		Horizontal/Vertical	
	Old Part Number	Order Number	Old Part Number	Order Number	Old Part Number	Order Number
Horizontal	MM3G60PP4M010	<a href="#">120098-0204</a>	MM3G61PP4M010	<a href="#">120098-0207</a>	MM3G70PP4M010	<a href="#">120098-0211</a>
	MM3G60PP4M050	<a href="#">120098-0205</a>	MM3G61PP4M050	<a href="#">120098-0208</a>	MM3G70PP4M050	<a href="#">120098-0212</a>
Vertical with Programming Port	MP3G62PP4M010	<a href="#">120098-0206</a>	MP3G63PP4M010	<a href="#">120098-0209</a>	MP3G72PP4M010	<a href="#">120098-0213</a>
	MP3G62PP4M050	<a href="#">120098-0154</a>	MP3G63PP4M050	<a href="#">120098-0210</a>	MP3G72PP4M050	<a href="#">120098-0214</a>

## D-Sub (9-pin) to Micro-Change® (M12) Cordsets

Single Reverse Keyway (end of segment) Module Connection									
Configuration	Cable Length (m)	Male Straight		Male 90°		Female Straight		Female 90°	
		Old Part No.	Order No.	Old Part No.	Order No.	Old Part No.	Order No.	Old Part No.	Order No.
Horizontal	1.0	BM5S60PP4M010	<a href="#">120098-0062</a>	BM5S61PP4M010	<a href="#">120098-0223</a>	BM5S30PP4M010	<a href="#">120098-0155</a>	BM5S31PP4M010	<a href="#">120098-0184</a>
	5.0	BM5S60PP4M050	<a href="#">120098-0064</a>	BM5S61PP4M050	<a href="#">120098-0157</a>	BM5S30PP4M050	<a href="#">120098-0055</a>	BM5S31PP4M050	<a href="#">120098-0185</a>
Vertical with Programming Port	1.0	BP5S62PP4M010	<a href="#">120098-0079</a>	BP5S63PP4M010	<a href="#">120098-0181</a>	BP5S32PP4M010	<a href="#">120098-0183</a>	BP5S33PP4M010	<a href="#">120098-0077</a>
	5.0	BP5S62PP4M050	<a href="#">120098-0081</a>	BP5S63PP4M050	<a href="#">120098-0182</a>	BP5S32PP4M050	<a href="#">120098-0075</a>	BP5S33PP4M050	<a href="#">120098-0161</a>

## D-Sub (9-pin) to Dual Micro-Change® (M12) Cordsets

Dual Reverse Keyway (Daisy chain) Module Connection											
Configuration	Cable Length (m)	Male Straight		Male 90°		Female Straight		Female 90°		Male Straight/Female Straight	
		Old Part No.	Order No.	Old Part No.	Order No.	Old Part No.	Order No.	Old Part No.	Order No.	Old Part No.	Order No.
Horizontal	1.0	BM5G60PP4M010	<a href="#">120098-0150</a>	BM5G61PP4M010	<a href="#">120098-0151</a>	BM5G30PP4M010	<a href="#">120098-0190</a>	BM5G31PP4M010	<a href="#">120098-0194</a>	BM5G70PP4M010	<a href="#">120098-0048</a>
	5.0	BM5G60PP4M050	<a href="#">120098-0045</a>	BM5G61PP4M050	<a href="#">120098-0187</a>	BM5G30PP4M050	<a href="#">120098-0191</a>	BM5G31PP4M050	<a href="#">120098-0195</a>	BM5G70PP4M050	<a href="#">120098-0180</a>
Vertical	1.0	BM5G62PP4M010	<a href="#">120098-0186</a>	BM5G63PP4M010	<a href="#">120098-0188</a>	BM5G32PP4M010	<a href="#">120098-0192</a>	BM5G33PP4M010	<a href="#">120098-0196</a>	BM5G72PP4M010	<a href="#">120098-0051</a>
	5.0	BM5G62PP4M050	<a href="#">120098-0047</a>	BM5G63PP4M050	<a href="#">120098-0189</a>	BM5G32PP4M050	<a href="#">120098-0193</a>	BM5G33PP4M050	<a href="#">120098-0197</a>	BM5G72PP4M050	<a href="#">120098-0053</a>

# PROFIBUS Receptacle

120099

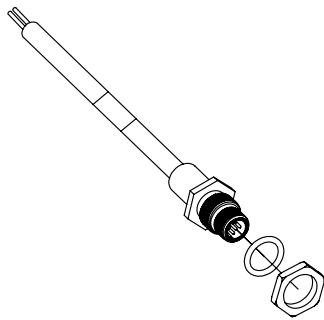

### Features and Benefits

- Used in control panels and junction boxes
- Epoxy potted for rugged industrial environments
- Male and female configurations
- Connects the external bus with an enclosure
- Front panel or back panel mount
- Bulkhead feed-through
- Wire or cable lead

### Electrical

Voltage: 250V AC/DC  
Current: 4.0A

### Mechanical

Shell: Nickel-Plated Brass  
Insert: Nylon 6/6  
Conductors: Receptacles—#22 AWG PVC  
Bulkhead Feed-Through—Solid Phosphor Bronze  
O-Ring: Nitrile rubber

### Environmental

Protection: IP67

### Cable Construction

Jacket Material: PUR  
Inner Material Insulation: PE insulation  
Shield Type: PETP/AV foil, Tinned Copper braid 65%  
Conductor: Twisted pair 24 AWG

### Cable Flex Information

Torsion: Survived more than 2 million cycles at 360° over 1m  
C-Track: Survived more than 3 million cycles at acceleration of 10m/s<sup>2</sup> and process speed up to 5m/s  
Bend Radius: 7.5 x cable diameter (static)

### Cable

Outside Diameter: 8 ± 0.2mm

## Data Line Micro-Change® (M12)

Mounting Style	Cable Length (m)	Male Straight		Female Straight	
		Old Part No.	Order No.	Old Part No.	Order No.
Back Panel	1.0	BR5U76PP4M0103	<a href="#">120099-0013</a>	BR5U70PP4M0103	<a href="#">120099-0005</a>
	5.0	BR5U76PP4M0503	<a href="#">120099-0019</a>	BR5U70PP4M0503	<a href="#">120099-0010</a>

## Trunk

Mounting Style	Wire Length	Male Straight		Female Straight		Horizontal/Vertical	
		Old Part No.	Order No.	Old Part No.	Order No.	Old Part No.	Order No.
Front Panel	3"	81688-030	<a href="#">120099-0025</a>	81689-030	<a href="#">120099-0024</a>	BR5L30	<a href="#">120099-0001</a>

# PROFIBUS Terminator and Tee

120101/120102

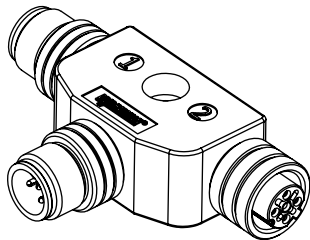

### Features and Benefits

- Shielded to reduce RFI/EMI and improve signal integrity
- Male reverse key Micro-Change® terminator
- M12 threads
- Provides quick disconnection of bus line
- Allows disconnection of node without shutting down the network
- Used with remote activity I/O modules

### Electrical

Voltage: Data Line Tee—30V AC/36V DC  
Terminators—250V AC/DC  
Current: 4A

### Mechanical

Connector Face: Nylon 6/6  
Molded Body: PVC  
O-Ring: Data Line Tee—Viton  
Terminators—Nitrile number  
Coupling Nuts: Nickel-plated Brass  
Shielding Sleeves: Nickel-plated Brass

### Environmental

Protection: Data Line Tee—IP67 (IEC 605290)  
Terminators—IP67

### General

Coupling nuts, pin 5 and PCB all connected to provide full shielding; Reverse key for Profibus circuitry includes line balancing inductors

Industrial Products

S

## Data Line Micro-Change® (M12) Tee

Old Part No.	Order No.
PDT501	<a href="#">120101-0002</a>

## Micro-Change (M12) Terminator

Old Part No.	Order No.
BO5506	<a href="#">120102-0002</a>

## Tee Gender Configuration Chart

Male	Female	Male
Bus in	Bus Out	Drop Bus

# PROFIBUS Field-Attachable Connector

## 120100/120103

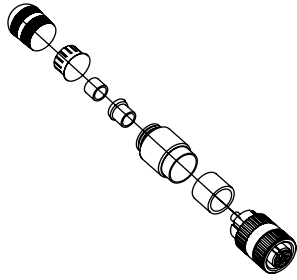

### Features and Benefits

- Shielded to reduce RFI/EMI and improve signal integrity
- D-Sub IDC with or without built-in diagnostics
- Male and female configurations
- Field termination for specific length or repair
- Easy field installation of quick-disconnect design
- D-Sub horizontal or vertical

### Mirco-Change® (M12)

#### Electrical

Voltage: 250V AC/DC  
Current: 4.0A

#### Mechanical

Connector Face: Polyamide  
Body: Nickel-plated Brass  
Contact: Silver-plated Brass  
Coupling Nut: Nickel-plated Brass  
Grommet: Nitrile rubber  
Conductor Size: 22 AWG

#### Environmental

Protection: IP67

### D-Sub

#### Electrical

Voltage: 30V AC/DC  
Current: 4.0A

#### Mechanical

Housing: Diecast Zinc  
Housing Material: ABS  
Cable Diameter: 8.0mm  
Cable Connection: IDC technology  
Terminating Resistor: Yes, externally switch selectable

#### Environmental

Protection: IP20

### Micro-Change® (M12)

Male Straight		Female Straight	
Old Part No.	Order No.	Old Part No.	Order No.
BA5506-32	<a href="#">120100-0002</a>	BA5500-32	<a href="#">120100-0001</a>

### D-Sub

	Vertical		Horizontal		45°	
	Old Part No.	Order No.	Old Part No.	Order No.	Old Part No.	Order No.
With Diagnostics	PA9D01-42	<a href="#">120103-0001</a>	MA9D00-42	<a href="#">120103-5001</a>	PA9D08-42	<a href="#">120103-0003</a>
Without Diagnostics	PA9S01-42	<a href="#">120103-0005</a>				

# Ethernet Cordset RJ45 Threaded

## 130050

### Single and Double-Ended

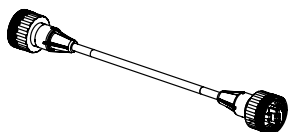

#### Features and Benefits

- Overmolded threaded connectors for secure, robust IP67 connection between Ethernet nodes
- First IP67 industrial Ethernet connector
- Category 5e compliant
- Achieves IEC IP67 rated seal when mated with a RJ-Lnxx® receptacle

#### Unshielded Stranded PVC

##### Physical

Cable: Stranded  
 Conductors: #24 AWG stranded tinned Copper  
 Insulation: Polyolefin 0.037" (0.94mm) nominal diameter  
 Pair: 2 insulated conductors twisted together, lay lengths varied between pairs to minimize cross talk  
 Core: 4 pairs cabled together  
 Binder: Polyester tape, 20% overlay minimum  
 Jacket: PVC 0.025" (0.635mm) nominal thickness  
 Diameter: 0.220" (5.588mm) nominal  
 Wiring Sequence: 568B

##### Electrical

Cable: Stranded  
 Capacitance: 15 pF/FT  
 Velocity of Propagation: 70% nominal  
 Conductor DC Resistance: 9.0/100 meter max.  
 Impedance: 100 ±15 ohms  
 Delay Skew: 10 nS/100 meter typical,  
 25 nS/100 meter max.  
 TIA/EIA Rating: Category 5E

Frequency (MHz)	Attenuation (dB/100 M max.)	Next (dB min)
1	1.9	76
4	3.9	72
16	7.9	61
20	9.0	60
31.25	11.0	55
62.5	15.9	53
100	20.7	50

#### Shielded Solid PUR

##### Physical

Cable: Solid core  
 Conductors: #24 AWG solid bare Copper, 0.020" (0.510mm)  
 Insulation: 0.009" (0.229mm) of cellular polyethylene,  
 0.04" (1.0mm) nominal diameter  
 Pair: 2 insulated conductors twisted together, lay lengths varied between pairs to minimize cross talk  
 Core: 4 pairs cabled together  
 Binder: Polyester tape, 20% overlay minimum  
 Shield: Aluminum/polyester tape, 20% overlay minimum  
 Drain Wire: #24 AWG stranded (3/32") Tin-plated Copper  
 Jacket: Black polyurethane 0.025" (.635mm) nominal thickness  
 Diameter: 0.245" (6.223mm) nominal  
 Wiring Sequence: 568B

##### Electrical

Cable: Solid  
 Capacitance: 5.6 nF/100 meter max.  
 Velocity of Propagation: 72% nominal  
 Conductor DC Resistance: 9.38/100 meter max.  
 Impedance: 100 ±15 ohms  
 Delay Skew: 45 nS/100 meter max.  
 TIA/EIA Rating: Category 5E

Frequency (MHz)	Attenuation (dB/100 M max.)	Next (dB min)
1	2.0	65.3
4	4.1	56.3
10	6.5	50.3
16	8.2	47.3
20	9.3	45.8
31.25	11.7	42.9
62.5	17.0	38.4
100	22.0	35.3

#### Shielded Stranded PUR

##### Physical

Cable: Proplex™ Kevlar wrapped  
 Conductors: #26 AWG stranded bare copper  
 Insulation: Color coded HFFR, halogen free, 0.035" (0.90mm) nominal diameter  
 Pair: Cabled with Kevlar strength member and tape wrapped  
 Core: 4 pairs cabled together  
 Shield: Inner—Aluminum mylar, 100% coverage  
 Outer—Tinned Copper  
 Braid—80% coverage  
 Jacket: Black urethane 0.059" (1.5mm) nominal thickness  
 Diameter: 0.287" (7.3mm) nominal  
 Wiring Sequence: 568B

##### Electrical

Cable: Proplex Kevlar wrapped  
 Capacitance: 4.6 nF/100 meters  
 Propagation Delay: 5.2 nS/M maximum  
 Conductor DC Resistance: 15/100 meter max.  
 Impedance: 100 ±15 ohms  
 Delay Skew: 20 nS/100 meter typical,  
 25 nS/100 meter max.  
 TIA/EIA Rating: Category 5E

Frequency (MHz)	Attenuation (dB/100 M max.)	Next (dB min)
1	3.15	62
4	6.45	53
16	12.3	44
20	13.8	42
31.25	17.7	40
62.5	25.6	35
100	33.0	32

Cable Type	Length (m)	Single-Ended		Double-Ended			
		Industrial Male		Industrial Male/Industrial Male		Male Standard/Male Standard	
		Old Part No.	Order No.	Old Part No.	Order No.	Old Part No.	Order No.
Unshielded Stranded PVC	1.0	ENQ3105M010	<a href="#">130050-0506</a>	ENQ3115M010	<a href="#">130050-0251</a>	ENQ3335M010	<a href="#">130050-0507</a>
	5.0	ENQ3105M050	<a href="#">130050-0250</a>	ENQ3115M050	<a href="#">130050-0255</a>	ENQ3335M050	<a href="#">130050-0273</a>
Shielded Solid PUR	1.0	ENS3105M010	<a href="#">130050-0408</a>	ENS3115M010	<a href="#">130050-0412</a>	ENS3335M010	<a href="#">130050-0503</a>
	5.0	ENS3105M050	<a href="#">130050-0502</a>	ENS3115M050	<a href="#">130050-0416</a>	ENS3335M050	<a href="#">130050-0437</a>
Shielded Stranded PUR (Proplex™) Kevlar Wrapped	1.0	ENP3105M010	<a href="#">130050-0162</a>	ENP3115M010	<a href="#">130050-0170</a>	ENP3335M010	<a href="#">130050-0457</a>
	5.0	ENP3105M050	<a href="#">130050-0166</a>	ENP3115M050	<a href="#">130050-0174</a>	ENP3335M050	<a href="#">130050-0193</a>

# Micro-Change® (M12) Ethernet Cordset

130048

Single and Double-Ended

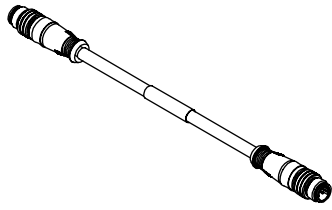

## Features and Benefits

- For connecting Micro-Change (M12) Ethernet system components in harsh industrial environments
- Category 5e compliant
- IP67 rated, perfect for harsh industrial environments
- D-coded to ensure proper alignment/mating

## Unshielded PVC

### Mechanical

Cable Conductors: 4/24 AWG stranded tinned wire  
Outside Diameter (Nom): 5.60mm  
Jacket Material: Teal PVC  
Inner Material Insulation: HDPE  
Certification: UL CMR

### Environmental

Protection: IP67

## Shielded PVC

### Electrical

TIA/EIA Rating: CAT5E  
UL: CL2

### Mechanical

Connector Face: PUR  
Molded Body: Black PUR  
Coupling Nut: Nickel-plated Brass  
Cable Conductors: 4/24 AWG stranded tinned wire  
Outside Diameter (Nom): 6.10mm  
Jacket Material: Teal PVC  
Inner Material Insulation: Foamed Polypropylene  
Certification: UL CMR  
Shield Type: Foil shield: 100% coverage, 25% min. overlap

### Environmental

Protection: IP67

## Shielded PUR

### Mechanical

Cable Conductors: 4/22 AWG stranded tinned wire  
Outside Diameter (Nom): 6.50mm  
Jacket Material: Green PUR  
Inner Material Insulation: FRNC  
Certification: UL listed CMX  
Shield Type: Foil—100% coverage  
Braid—85% coverage

### Environmental

Protection: IP67, sun/oil resistant

## Single-Ended

Cable Type	Length (m)	Male Straight		Male 90°	
		Old Part No.	Order No.	Old Part No.	Order No.
Unshielded/Stranded Conductor/PVC Jacket	1.0	E10A00603M010	<a href="#">130048-0038</a>	E10A00703M010	<a href="#">130048-0062</a>
	5.0	E10A00603M050	<a href="#">130048-0040</a>	E10A00703M050	<a href="#">130048-0064</a>
Shielded/Stranded Conductor/PVC Jacket	1.0	E10A00610M010	<a href="#">130048-0046</a>	E10A00710M010	<a href="#">130048-0070</a>
	5.0	E10A00610M050	<a href="#">130048-0048</a>	E10A00710M050	<a href="#">130048-0072</a>
Shielded/Stranded Conductor/PUR Jacket	1.0	E10A00615M010	<a href="#">130048-0054</a>	E10A00715M010	<a href="#">130048-0078</a>
	5.0	E10A00615M050	<a href="#">130048-0056</a>	E10A00715M050	<a href="#">130048-0080</a>

## Double-Ended

Cable Type	Male Straight/Male Straight			Male Straight/Male 90°		Male 90°/Male 90°		Female Straight/Male Straight Crossover		Female Straight/Male RJ45	
	Length (m)	Old Part No.	Order No.	Old Part No.	Order No.	Old Part No.	Order No.	Old Part No.	Order No.	Old Part No.	Order No.
Unshielded/Stranded Conductor/PVC Jacket	0.2							E11B03003M002	<a href="#">130048-0193</a>		
	1.0	E11A06003M010	<a href="#">130048-0088</a>	E11A06203M010	<a href="#">130048-0137</a>	E11A06303M010	<a href="#">130048-0161</a>			E16A03003M010	<a href="#">130048-0197</a>
	5.0	E11A06003M050	<a href="#">130048-0090</a>	E11A06203M050	<a href="#">130048-0139</a>	E11A06303M050	<a href="#">130048-0164</a>			E16A03003M050	<a href="#">130048-0200</a>
Shielded/Stranded Conductor/PVC Jacket	0.2							E11B03015M002	<a href="#">130048-0195</a>		
	1.0	E11A06015M010	<a href="#">130048-0122</a>	E11A06215M010	<a href="#">130048-0153</a>	E11A06315M010	<a href="#">130048-0179</a>				
	5.0	E11A06015M050	<a href="#">130048-0126</a>	E11A06215M050	<a href="#">130048-0155</a>	E11A06315M050	<a href="#">130048-0183</a>				
Shielded/Stranded Conductor/PUR Jacket	1.0	E11A06010M010	<a href="#">130048-0114</a>	E11A06210M010	<a href="#">130048-0145</a>	E11A06310M010	<a href="#">130048-0170</a>				
	5.0	E11A06010M050	<a href="#">130048-0116</a>	E11A06210M050	<a href="#">130048-0147</a>	E11A06310M050	<a href="#">130048-0172</a>				

Note: Other standard lengths available. Please contact Molex.

# Ultra-Lock® (M12) Ethernet Cordset

120108/130048  
Double-Ended

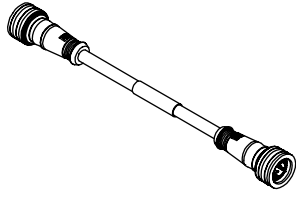

### Features and Benefits

- All the same benefits as the threaded Ethernet Cordsets, but with the patented Ultra-Lock connection system connectors
- Plug and play solution for quick field installation
- Superior performance, higher reliability and reduce installation time

### Unshielded PVC

#### Mechanical

Cable Conductors: 4/24 AWG stranded tinned wire  
Outside Diameter (Nom): 5.60mm  
Jacket Material: Teal PVC  
Inner Material Insulation: HDPE  
Certification: UL CMR

#### Environmental

Protection: IP67

### Shielded PVC

#### Electrical

TIA/EIA Rating: CAT5E  
UL: CL2

#### Mechanical

Connector Face: PUR  
Molded Body: Black PUR  
Coupling Nut: Nickel-plated Brass  
Cable Conductors: 4/24 AWG stranded tinned wire  
Outside Diameter (Nom): 6.10mm  
Jacket Material: Teal PVC  
Inner Material Insulation: Foamed Polypropylene  
Certification: UL CMR  
Shield Type: Foil shield: 100% coverage, 25% min. overlap

#### Environmental

Protection: IP67

### Shielded PUR

#### Mechanical

Cable Conductors: 4/22 AWG stranded tinned wire  
Outside Diameter (Nom): 6.50mm  
Jacket Material: Green PUR  
Inner Material Insulation: FRNC  
Certification: UL listed CMX  
Shield Type: Foil—100% coverage  
Braid—85% coverage

#### Environmental

Protection: IP67, sun/oil resistant

Cable Type	Length (m)	Old Part No.	Order No.	Description
Unshielded PVC	1.0	EWWA06003M010	<a href="#">120108-0066</a>	Male Straight/Male Straight
	5.0	EWWA06003M050	<a href="#">120108-0069</a>	
	1.0	EWWA06203M010	<a href="#">120108-0074</a>	Male Straight/Male 90°
	5.0	EWWA06203M050	<a href="#">120108-0076</a>	
	1.0	EWWA06303M010	<a href="#">120108-0082</a>	Male 90°/Male 90°
	5.0	EWWA06303M050	<a href="#">120108-0084</a>	
	0.2	E1WB03003M002	<a href="#">130048-0207</a>	Threaded Female Straight/Male Straight Crossover
Shielded PVC	1.0	EWWA06015M010	<a href="#">120108-0042</a>	Male Straight/Male Straight
	5.0	EWWA06015M050	<a href="#">120108-0044</a>	
	1.0	EWWA06215M010	<a href="#">120108-0050</a>	Male Straight/Male 90°
	5.0	EWWA06215M050	<a href="#">120108-0052</a>	
	1.0	EWWA06315M010	<a href="#">120108-0058</a>	Male 90°/Male 90°
	5.0	EWWA06315M050	<a href="#">120108-0060</a>	
	0.2	E1WB03015M002	<a href="#">130048-0209</a>	Threaded Female Straight/Male Straight Crossover
Shielded PUR	1.0	EWWA06010M010	<a href="#">120108-0090</a>	Male Straight/Male Straight
	5.0	EWWA06010M050	<a href="#">120108-0092</a>	
	1.0	EWWA06210M010	<a href="#">120108-0098</a>	Male Straight/Male 90°
	5.0	EWWA06210M050	<a href="#">120108-0100</a>	
	1.0	EWWA06310M010	<a href="#">120108-0106</a>	Male 90°/Male 90°
	5.0	EWWA06310M050	<a href="#">120108-0108</a>	
	0.2	E1WB03010M002	<a href="#">130048-0208</a>	Threaded Female Straight/Male Straight Crossover

Note: Other standard lengths available. Please contact Molex.

# Ethernet Receptacle RJ45 110 Punchdown

130053

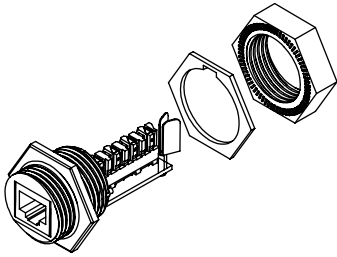

Old Part No.	Order No.
ENDR2FB5	<a href="#">130053-0002</a>

### Features and Benefits

- Simple field termination of cable using a standard punchdown tool
- Category 5e compliant
- Can be used with TIA 568A or 568B wiring sequences
- Color-coded block simplifies wiring

### Reference

TIA/EIA Rating: Category 5e compliant

### Electrical

Voltage: 125V DC  
Current: 1.5A

### Mechanical

O-Ring Material: Viton  
Insert Material: Acrylonitrile-Butadiene-Styrene (ABS)  
Overmold Material: Polyurethane  
Coupling Nut Material: Acrylonitrile-Butadiene-Styrene (ABS)  
Shell Material: Acrylonitrile-Butadiene-Styrene (ABS)  
Knockout Hole: 1.063"  
Thread Size: UNC 1" - 14  
Panel Thickness: With Gasket—0.125" max.  
Without Gasket—0.187" max., 0.062" min.  
Plating: RJ45 Jack—50µ Gold over 100µ Nickel  
Return Loss: 5 dB at 100 MHZ

### Environmental

Environmental Rating: IEC IP67

# Ethernet Receptacle Direct PCB Mount

130053

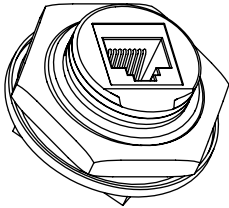

Old Part No.	Order No.
ENPR1FF5	<a href="#">130053-0004</a>

### Features and Benefits

- Ideal for OEMs looking to incorporate a sealed, robust connection into their field device
- Category 5e compliant
- Short depths for space constrained applications
- Achieves IP67 rated seal when mated with an RJ-Lnxx cordset- but also compatible with commercial RJ45 patch cords

### Reference

TIA/EIA Rating: Category 5e compliant

### Electrical

Voltage: 125V DC  
Current: 1.5A

### Mechanical

O-Ring Material: Viton  
Insert Material: Acrylonitrile-Butadiene-Styrene (ABS)  
Overmold Material: Polyurethane  
Coupling Nut Material: Acrylonitrile-Butadiene-Styrene (ABS)  
Shell Material: Acrylonitrile-Butadiene-Styrene (ABS)  
Knockout Hole: 1.063"  
Thread Size: UNC 1" - 14  
Panel Thickness: With Gasket—0.125" max.  
Without Gasket—0.187" max., 0.062" min.  
Plating: RJ45 Jack—50µ Gold over 100µ Nickel  
Return Loss: 5 dB at 100 MHZ

### Environmental

Environmental Rating: IEC IP67

# Ethernet Receptacle PC Board to Cable

130055

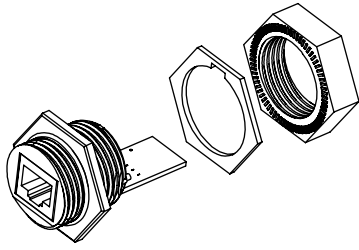

Old Part No.	Order No.
ENSRIFB5	<a href="#">130055-0016</a>

### Features and Benefits

- Highly flexible solution for OEMs looking to incorporate a sealed, robust receptacle into their field device or control panel
- Achieves IP67 rated seal when mated with an RJ-Lnxx cordset but also compatible with commercial RJ45 patch cords

### Reference

TIA/EIA Rating: Not rated as additional customer termination is required

### Electrical

Voltage: 125V DC  
Current: 1.5A

### Mechanical

O-Ring Material: Viton  
Insert Material: Acrylonitrile-Butadiene-Styrene (ABS)  
Overmold Material: Polyurethane  
Coupling Nut Material: Acrylonitrile-Butadiene-Styrene (ABS)  
Shell Material: Acrylonitrile-Butadiene-Styrene (ABS)  
Knockout Hole: 1.063"  
Thread Size: UNC 1" - 14  
Panel Thickness: With Gasket—0.125" max.  
Without Gasket—0.187" max., 0.062" min.  
RJ45 Jack Plating: 50µ Gold over 100µ of Nickel  
Return Loss: 5 dB at 100 MHZ

### Environmental

Environmental Rating: IEC IP67

# Ethernet Receptacle Solder PCB and Cable Termination

130055

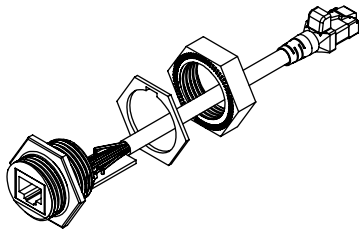

Old Part No.	Order No.	Description
ENSRIFB5M010	<a href="#">130055-0020</a>	
ENSP1F5M010	<a href="#">130055-0005</a>	Male RJ45

### Features and Benefits

- Highly flexible solution for incorporating a sealed, robust receptacle into a field device or control panel, particularly when the Ethernet transceiver is located some distance from the desired mounting point for the receptacle
- Achieves IEC IP67 rated seal when mated with an RJ-Lnxx cordset- but also compatible with commercial RJ45 patch cords

### Reference

TIA/EIA Rating: Not rated as additional customer termination is required

### Electrical

Voltage: 125V DC  
Current: 1.5A

### Mechanical

O-Ring Material: Viton  
Insert Material: Acrylonitrile-Butadiene-Styrene (ABS)  
Overmold Material: Polyurethane  
Coupling Nut Material: Acrylonitrile-Butadiene-Styrene (ABS)  
Shell Material: Acrylonitrile-Butadiene-Styrene (ABS)  
Knockout Hole: 1.063"  
Thread Size: UNC 1" - 14  
Panel Thickness: With Gasket—0.125" max.  
Without Gasket—0.187" max., 0.062" min.  
RJ45 Jack Plating: 50µ Gold over 100µ of Nickel  
Return Loss: 5 dB at 100 MHZ

### Environmental

Environmental Rating: IEC IP67



# Ultra-Lock® (M12) Ethernet Receptacle

120109  
4-Pole

### Features and Benefits

- Accepts both threaded and Ultra-Lock (M12) Cordsets
- Category 5e compliant
- IP67 rated, perfect for harsh industrial environments
- D-coded to ensure proper alignment/mating
- Board locking feature for more secure mounting

### Electrical

Voltage: 215V  
Current: 4.0A  
TIA/EIA Rating: Category 5E

### Mechanical

Shell: Nickel-Plated Brass  
Insert: PUR  
Conductors: Brass Gold plated/Bronze selective Gold plated  
O-Ring: FPM (also called Viton or FKM)

### Environmental

Protection: IP67, sun/oil resistant

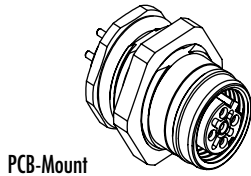

PCB-Mount

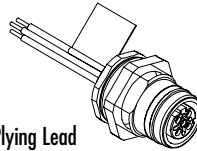

With 0.5m Flying Lead

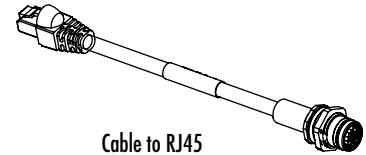

Cable to RJ45

Old Part No.	Order No.	Description	Mount
ERWD2U70	<a href="#">120109-5005</a>	PCB-Mount	Back-Panel Mount
ERWD2J30	<a href="#">120109-5003</a>		Front-Panel Mount/PG9
ERWD2U30	<a href="#">120109-5004</a>		Front-Panel Mount/M16
ERWAAU7000C050	<a href="#">120109-5002</a>	With 0.5 M Flying Lead	Back-Panel Mount
ERWAAJ3000C050	<a href="#">120109-0004</a>		Front-Panel Mount/PG9
ERWAAU3000C050	<a href="#">120109-5001</a>		Front-Panel Mount/M16
ERWPAU7003M006	<a href="#">120109-0005</a>	Cable to RJ45	Back-Panel Mount

### Adapters

Old Part No.	Order No.	Description	Mount
ER1PADAPTER	<a href="#">130054-0009</a>	Straight	Back-Panel Mount/ M16 to RJ45 Adapter
ER1PADAPTER90	<a href="#">130054-0010</a>	90°	

# Ethernet Field-Attachable Connector M12 Threaded

130047

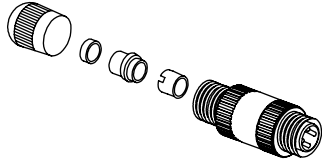

Old Part No.	Order No.	Description
EIAS06-52	<a href="#">130047-0018</a>	Male
EIAS00-52	<a href="#">130047-0017</a>	Female

### Features and Benefits

- Mirco-Change® (M12) field attachable connectors allow you to make field connections to bulk cable or single-ended cordsets
- Fast field termination without special tooling
- D-coded to ensure proper alignment/mating

### Electrical

Voltage: 32V  
Current: 4.0A

### Mechanical

Coupling Nut: Zinc die-cast  
Shell Material: Zinc die-cast  
Contacts: Gold-plated Palladium Nickel  
Cable: 22-24 AWG 0.25 to 0.34mm<sup>2</sup>  
Conductor Insulation: PVC  
Conductor Diameter: 1.60 to 2.0mm  
Conductor Cross-Section: 1.60 to 2.0mm  
Cable Diameter: 5.50 to 7.20mm

### Environmental

Protection: IP67

# Ethernet Field-Attachable Connector RJ45 Threaded

130057

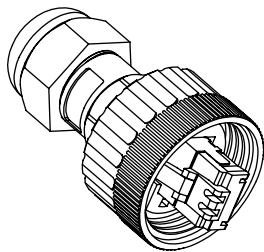

Old Part No.	Order No.	Description
ENQAM315	<a href="#">130057-0001</a>	RJ45 Connector (for Stranded Core Cable)
ENSAM315	<a href="#">130057-0003</a>	RJ45 Connector (for Solid Core Cable)

### Features and Benefits

- Create an industrial Ethernet cordset in the field using standard crimp tools
- Achieves IEC IP67 rated seal when mated with an RJ-Lnxx receptacle

### Mechanical

O-Ring Material: Viton  
Insert Material: Acrylonitrile-Butadiene-Styrene (ABS)  
Overmold Material: Polyurethane  
Coupling Nut Material: Acrylonitrile-Butadiene-Styrene (ABS)  
Shell Material: Acrylonitrile-Butadiene-Styrene (ABS)  
Thread Size: UNC 1" - 14

### Environmental

Environmental Rating: IEC IP67

# Receptacle Closure Cap

130058

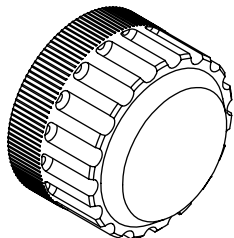

Old Part No.	Order No.	Rating
67-0300	<a href="#">130058-0035</a>	IP65
67-0301	<a href="#">130058-0036</a>	IP67

### Features and Benefits

- Attaches to RJ-Lnxx receptacles to provide an IEC IP65 rated seal for instances when a cordset is not mated

### Mechanical

Material: Protective Cap—PA6 Nylon GF (UV Stabilized)  
Lanyard—EPDM Rubber  
Thread Size: UNC 1" - 14

### Environmental

Environmental Rating: IEC IP65 (65-0300)  
IEC IP67 (67-0300)

# Woodhead® MAX-LOC® Strain Relief Cord Sealing Grip

130098/130099/130180

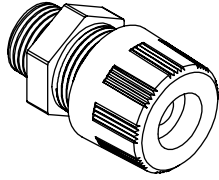

## Features and Benefits

- Highly resistant to impact
- Totally corrosion resistant
- Non-metallic MAX-LOC cord sealing grip will not support combustion
- Suitable for use in wet locations so long as the listed sealing ring is used between box and fitting

## Applications

- Electrical boxes
- Cabinets
- Push buttons
- Enclosures

## Reference Information

UL File No.: E76954

CSA File No.: LR32159

NEMA:

Without O-Ring—NEMA 3R

With O-Ring—NEMA 6P

## Mechanical

Strain Relief Force: 35 lb.

## Physical

Body: Nylon

Fitting: UL 94V-2

Old Part No.	Order No.	Cable Diameter Range	Mounting Thread	Body Style	NEMA Rating
5398	130098-0024	0.075-0.135"	1/4" NPT	Straight Male	NEMA 3R
5400	130098-0025	0.135-0.200"			
5402	130098-0026	0.200-0.265"			
5500	130098-0027	0.125-0.187"	3/8" NPT		
5502	130098-0029	0.187-0.250"			
5504	130098-0031	0.250-0.312"			
5506	130098-0032	0.312-0.375"			
5508	130098-0034	0.375-0.437"			
5518	130098-0036	0.062-0.125"			
5520	130098-0041	0.125-0.187"			
5522	130098-0046	0.187-0.250"			
5524	130098-0052	0.250-0.312"			
5526	130098-0061	0.312-0.375"			
5528	130098-0069	0.375-0.437"			
5530	130098-0076	0.437-0.500"			
5532	130098-0082	0.500-0.562"			
5518W	130098-0038	0.062-0.125"			
5520W	130098-0043	0.125-0.187"			
5522W	130098-0049	0.187-0.250"			
5524W	130098-0056	0.250-0.312"			
5526W	130098-0064	0.312-0.375"			
5528W	130098-0071	0.375-0.437"			
5530W	130098-0078	0.437-0.500"			
5532W	130098-0086	0.500-0.562"			
5620	130098-0235	0.187-1.250"	3/4" NPT		
5622	130098-0236	0.250-0.375"			
5624	130098-0225	0.375-0.437"			
5536	130098-0096	0.437-0.562"			
5538	130098-0103	0.500-0.625"			
5540	130098-0112	0.562-0.687"			
5542	130098-0118	0.625-0.750"			
5620W	130098-0215	0.187-1.250"			
5622W	130098-0221	0.250-0.375"			
5624W	130098-0227	0.375-0.437"			
5536W	130098-0099	0.437-0.562"			
5538W	130098-0107	0.500-0.625"			
5540W	130098-0114	0.562-0.687"			
5542W	130098-0121	0.625-0.750"			

Note: Additional thread sizes available, contact Molex

## Multi-Hole Strain Relief

Straight Male		Straight Male with O-Ring		Cable Size	No. of Holes	Mounting Thread
Old Part No.	Order No.	Old Part No.	Order No.			
5594-007	130098-0202	5594-007W	130098-0203	0.156"	2, 3 or 4 <sup>1</sup>	1/2" NPT
5594-008	130098-0204	5594-008W	130098-0205	0.187"	2, 3, 4, 5, 6 or 7 <sup>1</sup>	
5594-004	130098-0195	5594-004W	130098-0196	0.225"	2, 3 or 4 <sup>1</sup>	
5594-005	130098-0197	5594-005W	130098-0198	0.250"	2 or 3 <sup>1</sup>	
5594-006	130098-0199	5594-006W	130098-0200	0.290"	2	

Note: Additional thread sizes available, contact Molex

<sup>1</sup> Indicates one or more holes are covered by a thin membrane which can easily be "poked" open if required.

## O-Ring

Old Part No.	Order No.	Mounting Thread
00-0820	130180-0314	1/2" NPT
00-0822	130180-0333	3/4" NPT

## Lock Nut

Old Part No.	Order No.	Mounting Thread
5599	130099-0141	1/4" NPT
5600	130099-0142	3/8" NPT
5601	130099-0143	1/2" NPT
5602	130099-0144	3/4" NPT

# Woodhead® Strain Relief Deluxe Cord Grip

130097/130099

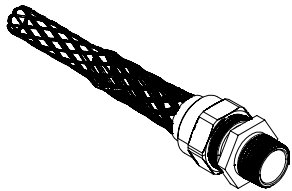

### Features and Benefits

- Stainless steel mesh with an aluminum body for corrosion resistance
- Offered in single/double weave construction to help absorb direct pull, to resist flexing and binding and to eliminate strain
- Recommended for indoor and outdoor use
- Suitable for use in hazardous locations per Class I, Div. 2, Class II, Div. 1 and 2, and Class III, Div. 1 and 2

### Applications

- Pendant stations
- Processing equipment
- Hand tools
- Extension cord sets

### Reference Information

UL File No.: E76954  
CSA File No.: LR32159  
Hazardous Locations:  
Class I, Div. 2  
Class II, Div. 1 and 2  
Class III, Div. 1 and 2

### Mechanical

Strain Relief Force: 35 lb

### Physical

Thread: NPT  
Body: Aluminum  
Woven Mesh: Stainless Steel

Straight Male		Cable Diameter Range	Mounting Thread
Old Part No.	Order No.		
36490	<a href="#">130097-0250</a>	0.187-0.250"	3/8" NPT
36430	<a href="#">130097-0225</a>	0.250-0.312"	
36431	<a href="#">130097-0226</a>	0.312-0.375"	
36432	<a href="#">130097-0227</a>	0.375-0.437"	
36250	<a href="#">130097-0160</a>	0.187-0.250"	1/2" NPT
36251	<a href="#">130097-0161</a>	0.250-0.375"	
36254	<a href="#">130097-0163</a>	0.375-0.500"	
36256	<a href="#">130097-0165</a>	0.500-0.625"	
36245	<a href="#">130097-0156</a>	0.625-0.750"	3/4" NPT
36246	<a href="#">130097-0157</a>	0.750-0.875"	
36257	<a href="#">130097-0166</a>	0.250-0.375"	
36259	<a href="#">130097-0167</a>	0.375-0.500"	
36261	<a href="#">130097-0168</a>	0.500-0.625"	
36263	<a href="#">130097-0170</a>	0.625-0.750"	
36248	<a href="#">130097-0158</a>	0.750-0.875"	

Note: Additional thread sizes available, contact Molex

Lock Nut		Gasket		Mounting Thread
Old Part No.	Order No.	Old Part No.	Order No.	
5600	<a href="#">130099-0142</a>	5610	<a href="#">130099-0148</a>	3/8" NPT
5601	<a href="#">130099-0143</a>	5611	<a href="#">130099-0149</a>	1/2" NPT
5602	<a href="#">130099-0144</a>	5612	<a href="#">130099-0150</a>	3/4" NPT

# Woodhead® Strain Relief Wide Range Dust Tight Grip

130097

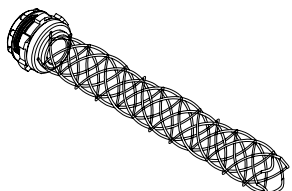

### Features and Benefits

- For indoor use
- Cost effective solution
- Dust tight, rubber membrane conforms to cable
- Includes insulated bushing

### Applications

- Enclosures
- Power boxes
- Machine tools
- Power centers

### Reference Information

UL File No.: E76954  
CSA File No.: LR32159

### Mechanical

Strain Relief Force: 35 lb

### Physical

Thread: NPT  
Body: Aluminum  
Woven Mesh: Galvanized Steel

Straight Male		Cable Diameter Range	Mounting Thread
Old Part No.	Order No.		
36501	<a href="#">130097-0256</a>	0.220-0.320"	1/2" NPT
36503	<a href="#">130097-0258</a>	0.300-0.430"	
36505	<a href="#">130097-0260</a>	0.400-0.540"	
36508	<a href="#">130097-0262</a>	0.520-0.730"	3/4" NPT

Note: Additional thread sizes available, contact Molex

# Woodhead® Support Grip for Fiber Optics

**130094**  
Closed Mesh, Single Eye

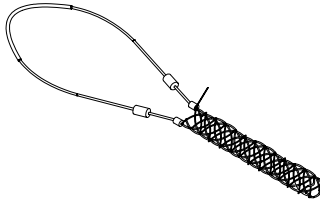

### Features and Benefits

- Used to support Fiber Optic communication lines for temporary or permanent applications
- Designed to reduce stress on fragile cables in vertical or sloping runs
- Woven nonmagnetic tinned bronze wire
- Available in both single eye and locking bale configurations

### Applications

- Vertical or sloping runs

### Reference Information

CSA File No.: LR32159

### Physical

Woven Mesh: Nonmagnetic Tinned Bronze wire

Old Part No.	Order No.	Cable Diameter Range	Bale Length	Mesh Length	Approximate Break Strength <sup>1</sup>
36670	<a href="#">130094-0522</a>	0.180-0.250"	3"	1.7"	300 lbs
36671	<a href="#">130094-0523</a>	0.230-0.320"	3"	2.5"	
36672	<a href="#">130094-0524</a>	0.300-0.390"	4"	2.5"	
36673	<a href="#">130094-0525</a>	0.370-0.480"	5"	4.0"	
36674	<a href="#">130094-0526</a>	0.460-0.580"	6"	4.0"	400 lbs
36675	<a href="#">130094-0527</a>	0.560-0.710"	7"	5.5"	600 lbs
36676	<a href="#">130094-0528</a>	0.690-0.880"	8"	6.0"	800 lbs

Note: Additional thread sizes available, contact Molex

<sup>1</sup> To determine workload safety factor, divide approximate break strength by 10.

# Woodhead® Pulling Grip for Fiber Optics

**130095**  
Closed Mesh, Rotating Eye

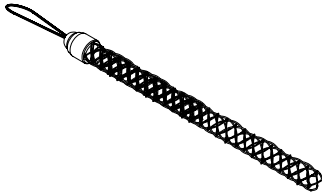

### Features and Benefits

- Used for installation of fiber optic communications lines
- Easily installed on cables and reusable
- Rotating eye eliminates torsional stress between your pulling apparatus and your cable for long runs

### Applications

- Underground
- Overhead
- Through conduit and/or enclosure-type pulls

### Reference Information

CSA File No.: LR32159

Old Part No.	Order No.	Cable Diameter Range	Bale Length	Mesh Length	Approximate Break Strength <sup>1</sup>
36662	<a href="#">130095-0298</a>	0.350-0.480"	5"	18"	2,200 lbs
36663	<a href="#">130095-0299</a>	0.420-0.610"		21"	2,800 lbs
36664	<a href="#">130095-0300</a>	0.530-0.740"		24"	3,300 lbs
36665	<a href="#">130095-0301</a>	0.640-0.870"		27"	4,700 lbs

Note: Additional thread sizes available, contact Molex

<sup>1</sup> To determine workload safety factor, divide approximate break strength by 10.

# Commercial Micro-D Connector

This commercial line of shielded Micro-D products with a 1.27mm (.050") pitch, offers an economical solution for commercial and industrial applications that require the density of a microminiature connector. The series is available in a right angle and vertical configuration, designed with a metal interface and grounding tabs for improved mechanical and electrical shield connection.

Also available is the cable receptacle, which has a "crimp and poke" configuration designed for hand or semi-automatic crimping. Our unique backshell design will maintain the integrity of the cable construction while the strain relief is crimped over the cable.

A wide variety of pre-made over-moulded cable assemblies are also available. Configurations include single-ended and double-end CMD, as well as CMD to standard D-sub connectors in 9, 15 and 25 circuit densities.

## Features

- Right angle plug available in 9, 15, 18, 25, 30 and 50 circuits
- Vertical plug available in 9, 15 and 25 circuits
- Cable receptacle available in 9, 15 and 25 circuits
- LCP insulator, stamped metal shell
- Crimp and poke contacts on the cable receptacle for customer termination
- Current: 1.0A max.
- UL File No: E34763

## Applications

- Commercial
- Computer I/O
- Data storage
- Telecommunications
- Industrial