

LightRanger click

2. Soldering the headers

Before using your click board™, make sure to solder 1x8 male headers to both left and right side of the board. Two 1x8 male headers are included with the board in the package.

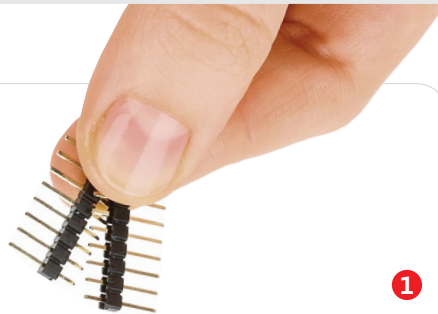

1

2

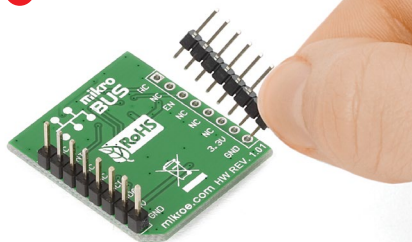

Turn the board upside down so that the bottom side is facing you upwards. Place shorter pins of the header into the appropriate soldering pads.

3

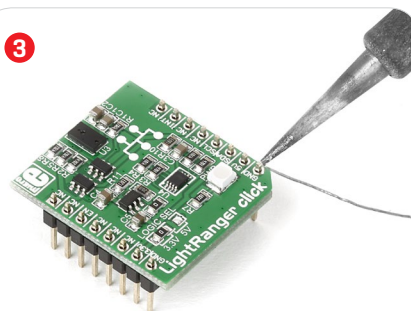

Turn the board upward again. Make sure to align the headers so that they are perpendicular to the board, then solder the pins carefully.

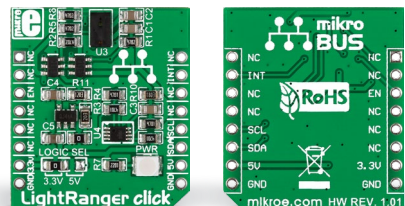

1. Introduction

LightRanger click is a proximity sensor carrying ST's VL6180X IC. This chip is based on ST's patented FlightSense™ technology which is more reliable compared to conventional infrared-based proximity sensors. LightRanger click communicates with the target board MCU through mikroBUS™ I²C pins [SCL, SDA], with additional interrupt [INT] and enable [EN, in place of default mikroBUS™ CS pin]. The board is designed to use either a 3.3V or 5V power supply.

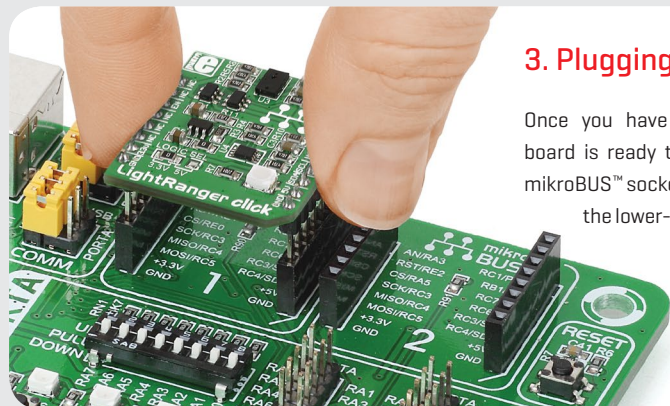

3. Plugging the board in

Once you have soldered the headers your board is ready to be placed into the desired mikroBUS™ socket. Make sure to align the cut in the lower-right part of the board with the markings on the silkscreen at the mikroBUS™ socket. If all the pins are aligned correctly, push the board all the way into the socket.

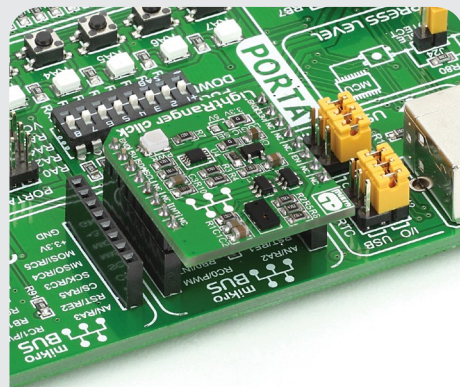

4. Essential features

The VL6180X sensor consists of an IR emitter, ambient light sensor, and range sensor. It calculates distance [up to 10cm with precision, up to 20cm otherwise] by measuring the time it takes for a photon to travel from the sensor to the nearest object and back [Time of Flight]. In contrast to conventional IR proximity sensors which derive distance by measuring the amount of light reflected, VL6180X works with all objects, regardless of their color or reflectivity.

click
BOARD™
www.mikroe.com



LightRanger click manual
ver 1.01



010000078556

5. Schematic

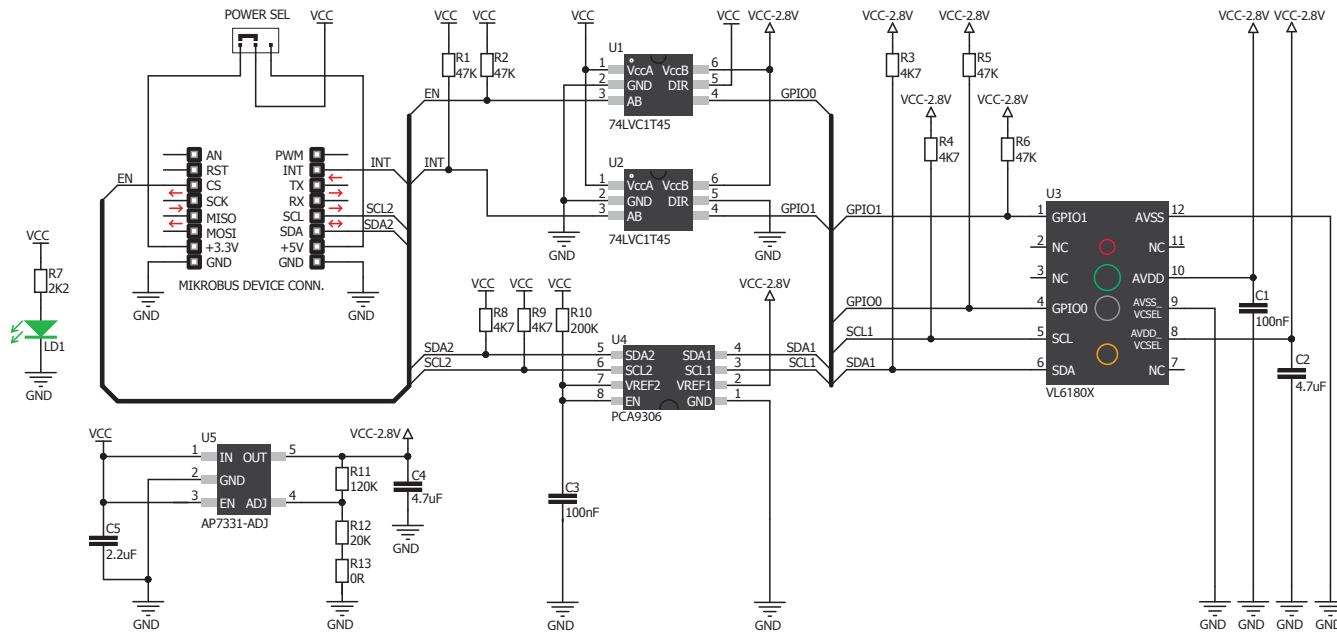

6. Dimensions

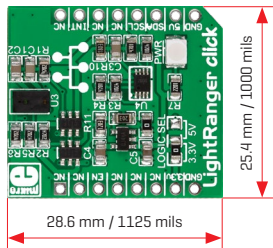

	mm	mils
LENGTH	28.6	1125
WIDTH	25.4	1000
HEIGHT*	3.3	130

* without headers

7. SMD jumper

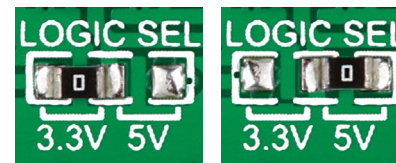

LightRanger click has a **LOGIC SEL** jumper [zero ohm resistor] that lets you switch the board form 3.3V to 5V power supply.

8. Code examples

Once you have done all the necessary preparations, it's time to get your click board™ up and running. We have provided examples for mikroC™, mikroBasic™ and mikroPascal™ compilers on our **Libstock** website. Just download them and you are ready to start.



9. Support

MikroElektronika offers **free tech support** [www.mikroe.com/support] until the end of the product's lifetime, so if something goes wrong, we're ready and willing to help!



10. Disclaimer

MikroElektronika assumes no responsibility or liability for any errors or inaccuracies that may appear in the present document. Specification and information contained in the present schematic are subject to change at any time without notice.

Copyright © 2015 MikroElektronika.
All rights reserved.