

### DESCRIPTION

In Microsemi's new Powermite3<sup>®</sup> SMT package, these high efficiency ultrafast rectifiers offer the power handing capabilities previously found only in much larger packages. They are ideal for SMD applications that operate at high frequencies.

In addition to its size advantages, Powermite3<sup>®</sup> package features include a full metallic bottom that eliminates the possibility of solder flux entrapment during assembly, and a unique locking tab acts as an integral heat sink. Its innovative design makes this device ideal for use with automatic insertion equipment.

**IMPORTANT:** For the most current data, consult MICROSEMI's website: <http://www.microsemi.com>

### ABSOLUTE MAXIMUM RATINGS AT 25° C (UNLESS OTHERWISE SPECIFIED)

Rating	Symbol	Value	Unit
Peak Repetitive Reverse Voltage Working Peak Reverse Voltage DC Blocking Voltage	$V_{RRM}$ $V_{RWM}$ $V_R$	60	V
RMS Reverse Voltage	$V_{R(RMS)}$	42	V
Average Rectified Output Current	$I_o$	3	A
Non-Repetitive Peak Forward Surge Current 8.3ms Single half sine wave Superimposed on Rated Load	$I_{FSM}$	100 @ 25 °C 50 @ 100 °C	A
Storage Temperature	T stg	-55 to +150	°C
Operating Temperature	T op	-55 to +125	°C

### THERMAL CHARACTERISTICS (UNLESS OTHERWISE SPECIFIED)

#### Thermal Resistance

Thermal Resistance	Symbol	Value	Unit
Junction-to Bottom	Rja (1)	2.5	°C/Watt

(1) When Mounted on PC board with 2 ounce copper pattern.

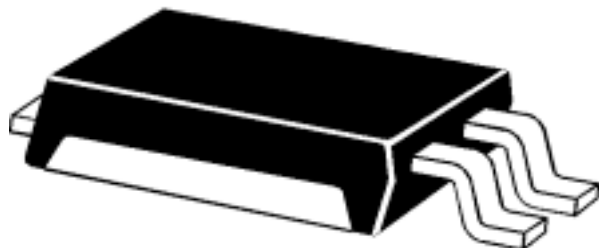

### KEY FEATURES

- High power surface mount package.
- Guard Ring die construction for transient protection.
- Silicon Schottky rectifiers no reverse voltage recovery.
- Internal heat sink locking tabs
- Low forward voltage.
- Full metallic bottom eliminates flux entrapment
- Compatible with automatic insertion equipment
- Low profile-maximum height of 1mm supplied in 16 mm tape reel- 5000 units/ 13" reel.

### APPLICATIONS/BENEFITS

- Switching and Regulating Power Supplies.
- Charge Pump Circuits.
- Reduces reverse recovery loss due to low  $I_{RM}$ .
- Small foot print  =  
190 X 300 mils  
1:1 Actual size

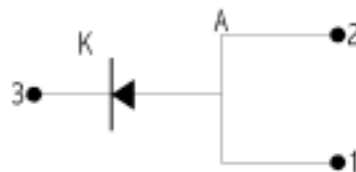

**ELECTRICAL PARAMETERS @ 25°C (unless otherwise specified)**

Parameter	Symbol	Conditions	Min	Typ.	Max	Units
Forward Voltage (Note 1)	$V_{Fm}$	$I_F = 3.5 \text{ A}, T_j = 25^\circ\text{C}$ $I_F = 3.5 \text{ A}, T_j = 125^\circ\text{C}$ $I_F = 7 \text{ A}, T_j = 25^\circ\text{C}$ $I_F = 7 \text{ A}, T_j = 25^\circ\text{C}$		0.59 0.53 0.72 0.63	0.63 0.57 0.76 0.67	V
Reverse Break Down Voltage (Note 1)	$V_{BR}$	$I_R = 0.2 \text{ mA}$	60			V
Reverse Current (Note1)	$I_{rm}$	$V_R = 60\text{V}, T_j = 25^\circ\text{C}$ $V_R = 60\text{V}, T_j = 100^\circ\text{C}$ $V_R = 60\text{V}, T_j = 125^\circ\text{C}$		2 0.6 2.5	200 20 150	$\mu\text{A}$ mA mA
Capacitance	$C_T$	$V_R = 4 \text{ V}; F = 1 \text{ MHz}$		130		pF

Note: 1 Short duration test pulse used to minimize self – heating effect.

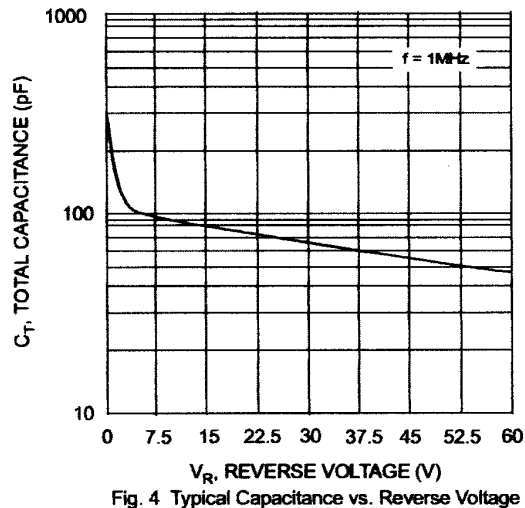
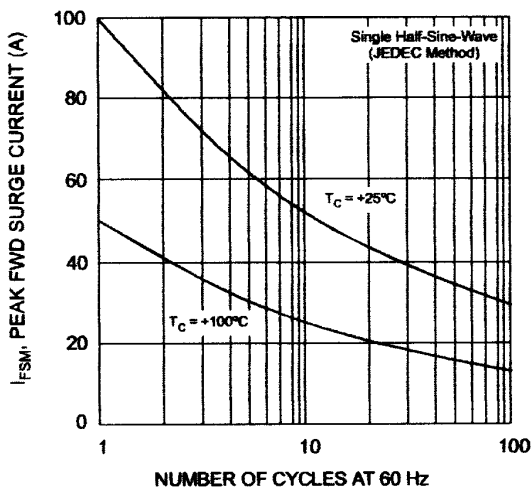
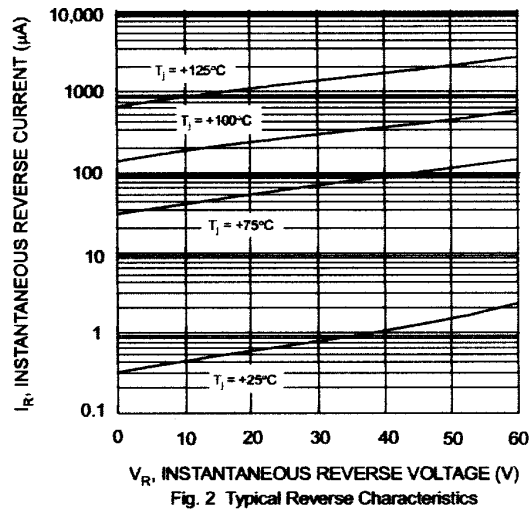
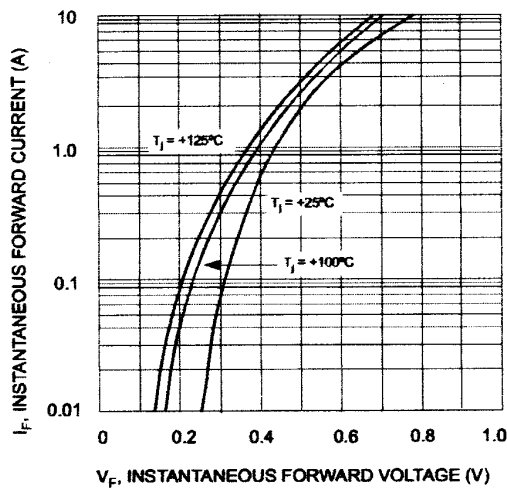

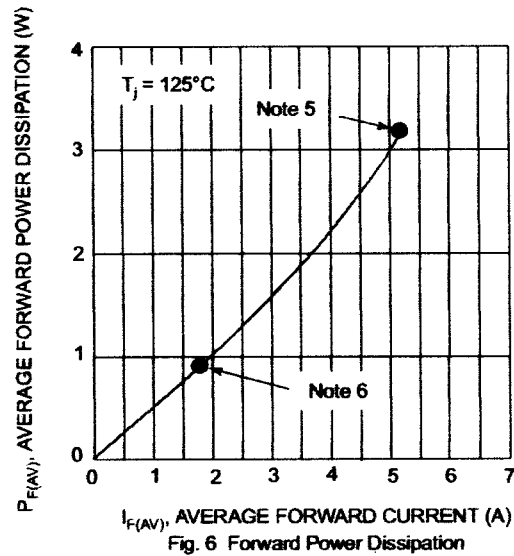
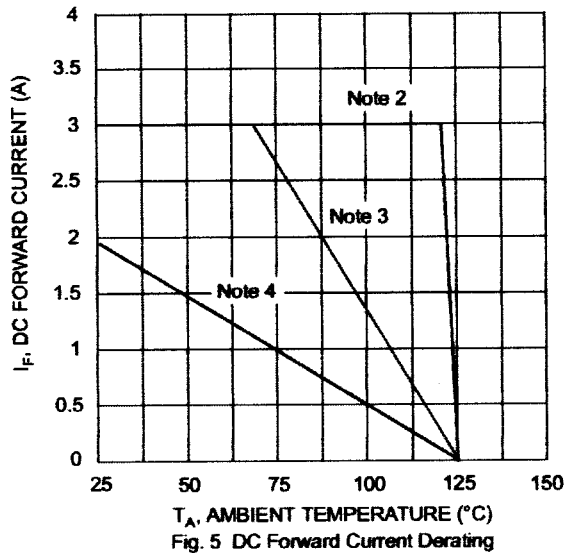

- Notes:
- $T_A = T_{\text{SOLDERING POINT}}$ ,  $R_{\theta JS} = 3.2^\circ\text{C/W}$ ,  $R_{\theta SA} = 0^\circ\text{C/W}$ .
  - Device mounted on GETEK substrate, 2"x2", 2 oz. copper, double-sided, cathode pad dimensions 0.75" x 1.0", anode pad dimensions 0.25" x 1.0".  $R_{\theta JA}$  in range of 20-40°C/W.
  - Device mounted on FR-4 substrate, 2"x2", 2 oz. copper, single-sided, pad layout as per Diodes Inc. suggested pad layout document AP02001 which can be found on our website at <http://www.diodes.com/datasheets/ap02001.pdf>.  $R_{\theta JA}$  in range of 100-120°C/W.
  - Maximum power dissipation when the device is mounted in accordance to the conditions described in Note 3.
  - Maximum power dissipation when the device is mounted in accordance to the conditions described in Note 4.

### PAD LAYOUT

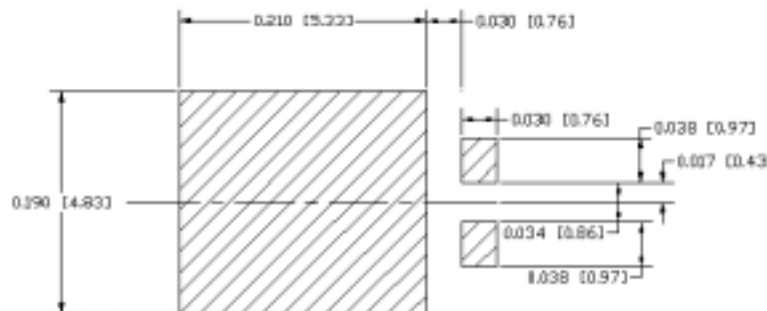

PRODUCT PRELIMINARY DATA – Information contained in this document is pre-production data, and is proprietary to Microsemi Corp. It may not be modified in any way without the express written consent of Microsemi Corp. Product referred to herein is not guaranteed to achieve preliminary or production status and product specifications, configurations, and availability may change at any time.

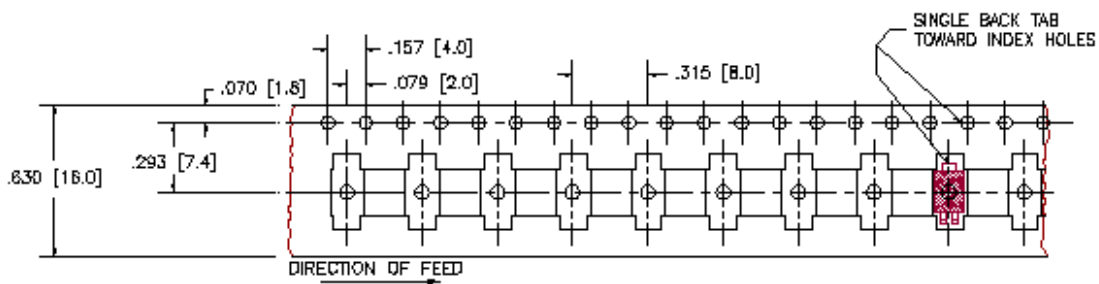
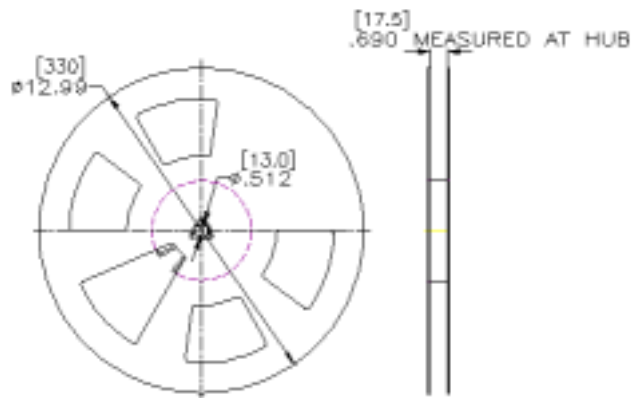
**16 mm TAPE**

**13 INCH REEL**

**MECHANICAL**



UPS360

3 A Schottky Barrier Rectifier

NOTES: