

DESCRIPTION

This UPS340e3 in the Powermite3[®] package is a high efficiency Schottky rectifier that is also RoHS compliant offering high current/power capabilities previously found only in much larger packages. They are ideal for SMD applications that operate at high frequencies. In addition to its size advantages, the Powermite3[®] package includes a full metallic bottom that eliminates the possibility of solder flux entrapment during assembly and a unique locking tab act as an efficient heat path to the heat-sink mounting. Its innovative design makes this device ideal for use with automatic insertion equipment.

IMPORTANT: For the most current data, consult MICROSEMI's website: <http://www.microsemi.com>


KEY FEATURES

- Very low thermal resistance package
- RoHS Compliant with e3 suffix part number
- Guard-ring-die construction for transient protection
- Efficient heat path with Integral locking bottom metal tab
- Low forward voltage
- Full metallic bottom eliminates flux entrapment
- Compatible with automatic insertion
- Low profile-maximum height of 1mm

ABSOLUTE MAXIMUM RATINGS AT 25° C (UNLESS OTHERWISE SPECIFIED)

Rating	Symbol	Value	Unit
Peak Repetitive Reverse Voltage Working Peak Reverse Voltage DC Blocking Voltage	V_{RRM} V_{RWM} V_R	40	V
RMS Reverse Voltage	$V_{R(RMS)}$	28	V
Average Rectified Output Current	I_o	3	A
Non-Repetitive Peak Forward Surge Current 8.3ms Single half sine wave Superimposed on Rated Load@ $T_c = 90^\circ C$	I_{FSM}	50	A
Storage Temperature	T_{STG}	-55 to +150	°C
Junction Temperature	T_J	-55 to +125	°C

APPLICATIONS/BENEFITS

- Switching and Regulating Power Supplies.
- Silicon Schottky (hot carrier) rectifier for minimal reverse voltage recovery
- Elimination of reverse-recovery oscillations to reduce need for EMI filtering
- Charge Pump Circuits
- Reduces reverse recovery loss with low I_{RM}
- Small foot print  = 190 X 270 mils (1:1 Actual size)
See mounting pad details on pg 3

MECHANICAL & PACKAGING

- CASE: Void-free transfer molded thermosetting epoxy compound meeting UL94V-0
- FINISH: Annealed matte-Tin plating over copper and readily solderable per MIL-STD-750 method 2026 (consult factory for Tin-Lead plating)
- POLARITY: See figure (left)
- MARKING: S340•
- WEIGHT: 0.072 gram (approx.)
- Package dimension on last page
- Tape & Reel option: 16 mm tape per Standard EIA-481-B, 5000 on 13" reel

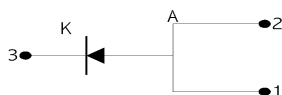
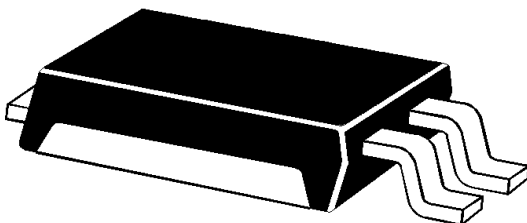
THERMAL CHARACTERISTICS

Thermal Resistance

Junction-to-case (bottom)	$R_{\theta JC}$	3.2	°C/ Watt
Junction to ambient (1)	$R_{\theta JA}$	65	°C/ Watt

(1) When mounted on FR-4 PC board using 2 oz copper with recommended minimum foot print

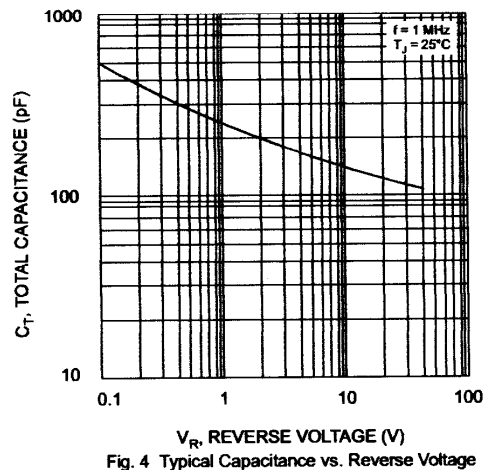
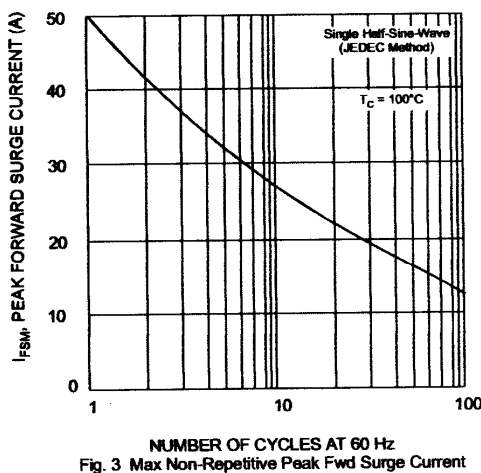
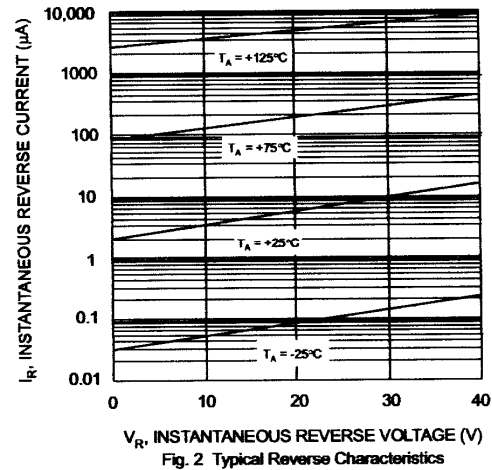
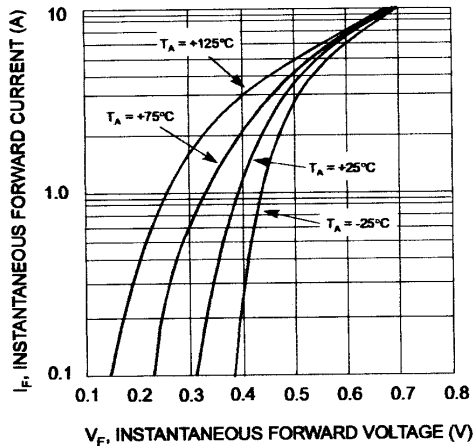
Powermite 3™

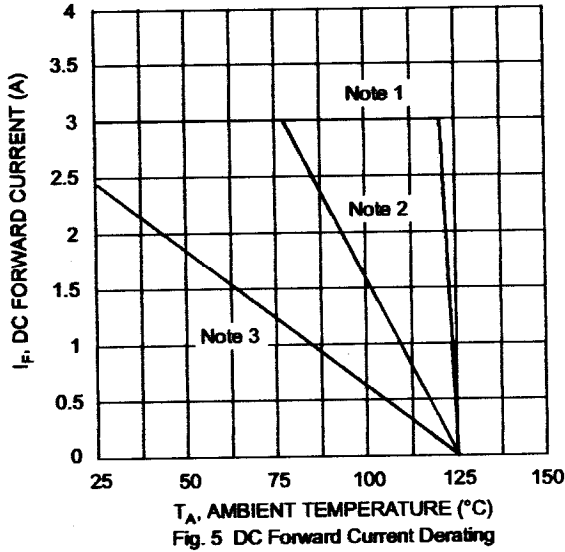
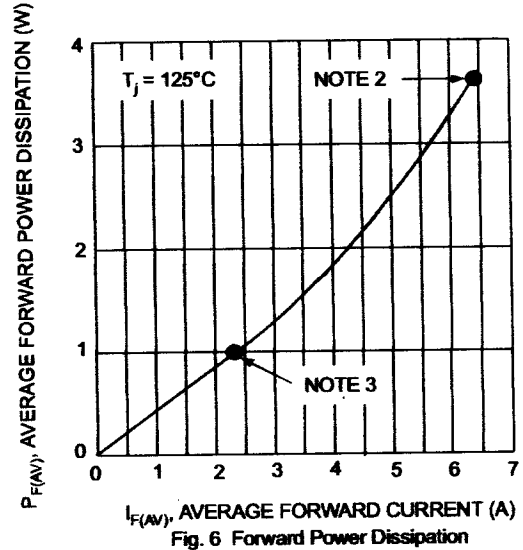


ELECTRICAL PARAMETERS @ 25°C (unless otherwise specified)

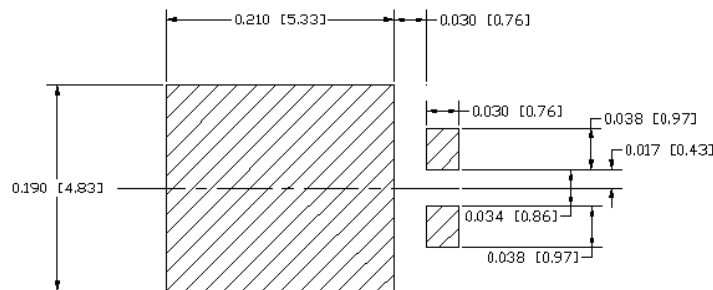
Parameter	Symbol	Conditions	Min	Typ.	Max	Units
Forward Voltage (Note 1)	V_F	$I_F = 3\text{ A}, T_J = 25^\circ\text{C}$ $I_F = 3\text{ A}, T_J = 125^\circ\text{C}$ $I_F = 6\text{ A}, T_J = 25^\circ\text{C}$ $I_F = 6\text{ A}, T_J = 125^\circ\text{C}$		0.46 0.40 0.57 0.54	0.50 0.44 0.61 0.58	V
Reverse Break Down Voltage (Note 1)	V_{BR}	$I_R = 0.5\text{ mA}$	40			V
Reverse Current (Note 1)	I_R	$V_R = 40\text{V}, T_J = 25^\circ\text{C}$ $V_R = 40\text{V}, T_J = 100^\circ\text{C}$		15 10	500 20	μA mA
Capacitance	C_T	$V_R = 4\text{ V}; f = 1\text{ MHz}$		180		pF

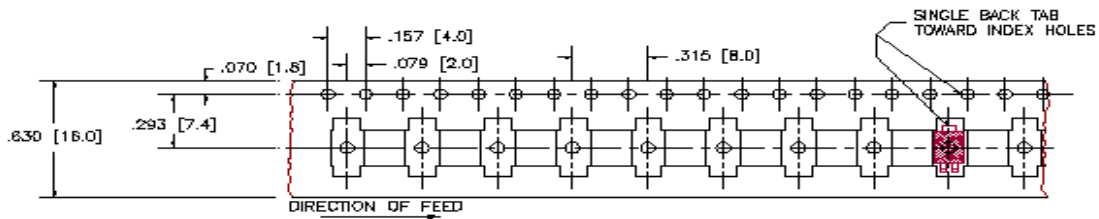
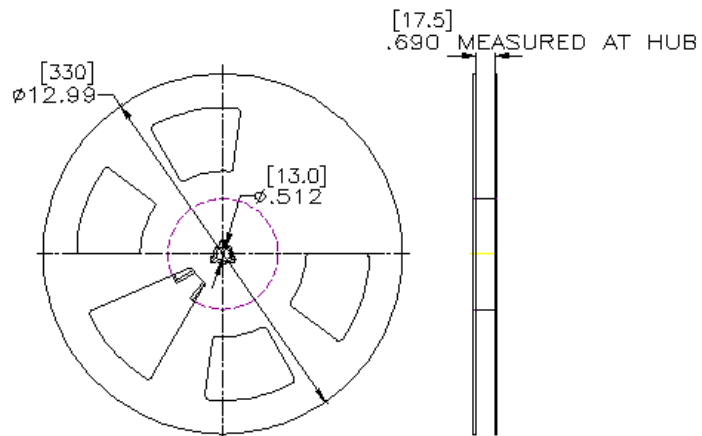
Note: 1 Short duration test pulse used to minimize self – heating effect.

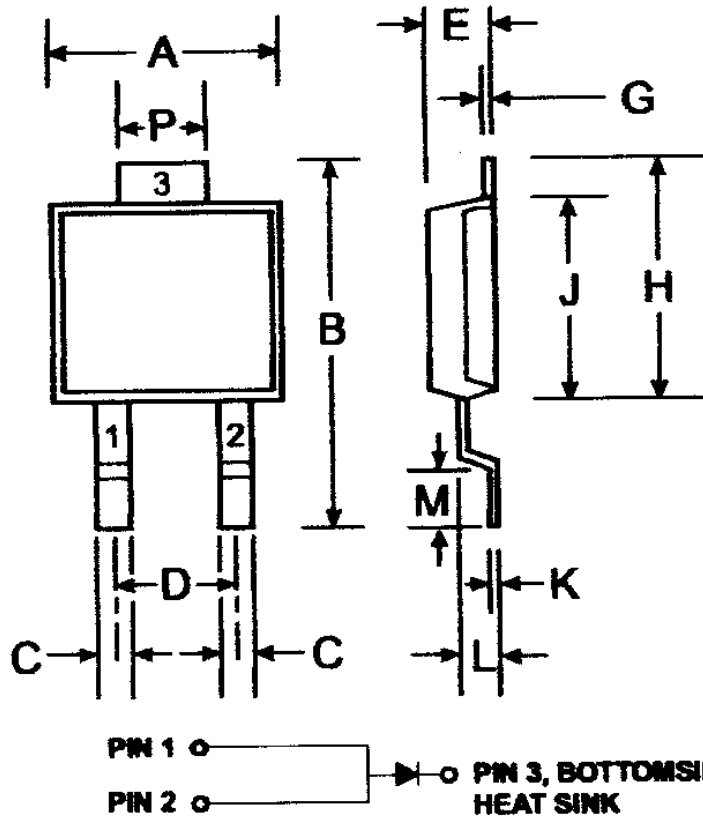



Fig. 5 DC Forward Current Derating

Fig. 6 Forward Power Dissipation

- Notes:
1. $T_A = T_{\text{SOLDERING POINT}}$, $R_{\theta JS} = 3.2^\circ \text{C/W}$, $R_{\theta SA} = 0^\circ \text{C/W}$.
 2. Device mounted on GETEK substrate, 2" x 2", 2 oz. copper, double-sided, cathode pad dimensions 0.75" x 1.0", anode pad dimensions 0.25" x 1.0". $R_{\theta JA}$ in range of 20-40° C/W.
 3. Device mounted on FRA-4 substrate, 2" x 2", 2 oz. copper, single-sided, pad layout $R_{\theta JA}$ in range of 65° C/W. See mounting pad below.

MOUNTING PAD DIMENSIONS (inches)


TAPE & REEL**13 INCH REEL**

PACKAGE DIMENSIONS


Note: Pins 1 & 2 must be electrically connected at the printed circuit board.

POWERMITE®3		
Dim	Min	Max
A	4.03	4.09
B	6.40	6.61
C	.889 NOM	
D	1.83 NOM	
E	1.10	1.14
G	.178 NOM	
H	5.01	5.17
J	4.37	4.43
K	.178 NOM	
L	.71	.77
M	.36	.46
P	1.73	1.83
All Dimensions in mm		



UPS340e3

3 A LOW Vf Schottky Barrier Rectifier

NOTES: