

# Ultrafast Recovery Modules UFT200, 201 & 202

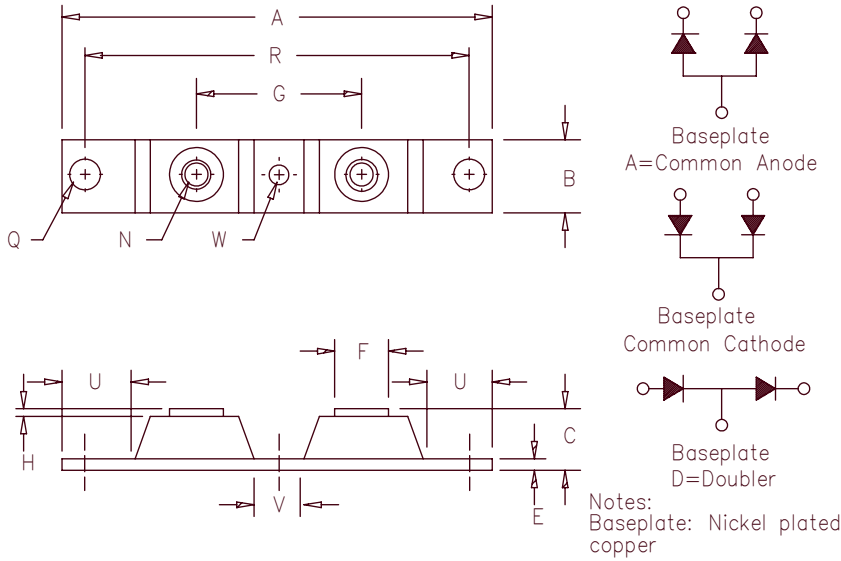

Dim.	Inches		Millimeters		Notes
	Min.	Max.	Min.	Max.	
A	---	3.630	---	92.20	
B	0.700	0.800	17.78	20.32	
C	---	0.630	---	16.00	
E	0.120	0.130	3.05	3.30	
F	0.490	0.510	12.45	12.95	
G	1.375 BSC		34.92 BSC		
H	0.010	---	0.25	---	
N	---	---	---	---	1/4-20
Q	0.275	0.290	6.99	7.37	Dia.
R	3.150 BSC		80.01 BSC		
U	0.600	---	15.24	---	
V	0.312	0.340	7.92	8.64	
W	0.180	0.195	4.57	4.95	Dia.

Microsemi Catalog Number	Working Peak Reverse Voltage	Repetitive Peak Reverse Voltage
UFT20005*	50V	50V
UFT20010*	100V	100V
UFT20015*	150V	150V
UFT20020*	200V	200V
UFT20120*	200V	200V
UFT20130*	300V	300V
UFT20140*	400V	400V
UFT20150*	500V	500V
UFT20260*	600V	600V
UFT20270*	700V	700V
UFT20280*	800V	800V

Add Suffix A for Common Anode, D for Doubler

- Ultra Fast Recovery
- 175°C Junction Temperature
- $V_{RRM}$  50 to 800 Volts
- High surge capacity
- 2 X 100 Amp current rating
- ROHS Compliant

## Electrical Characteristics

		UFT200	UFT201	UFT202	
Average forward current per pkg	$I_F(AV)$	200A	200A	200A	Square Wave
Average forward current per leg	$I_F(AV)$	100A	100A	100A	Square Wave
Case Temperature	TC	135°C	120°C	115°C	$R_{\theta JC} = 0.5^\circ C/W$
Maximum surge current per leg	$I_{FSM}$	1500A	1400A	1200A	8.3ms, half sine, $T_J = 175^\circ C$
Max peak forward voltage per leg	$V_{FM}$	.975V	1.25V	1.35V	$I_{FM} = 100A; T_J = 25^\circ C^*$
Max reverse recovery time per leg	$t_{rr}$	50ns	70ns	90ns	1/2A, 1A, 1/4A, $T_J = 25^\circ C$
Max peak reverse current per leg	$I_{RM}$	---	6.0mA	---	$V_{RRM}, T_J = 125^\circ C$
Max peak reverse current per leg	$I_{RM}$	---	50 $\mu$ A	---	$V_{RRM}, T_J = 25^\circ C$
Typical Junction capacitance	$C_J$	575pF	300pF	275pF	$V_R = 10V, T_J = 25^\circ C$

\*Pulse test: Pulse width 300 $\mu$ sec, Duty cycle 2%

## Thermal and Mechanical Characteristics

Storage temp range	$T_{STG}$	-55°C to 175°C
Operating junction temp range	$T_J$	-55°C to 175°C
Max thermal resistance per leg	$R_{\theta JC}$	0.5°C/W Junction to case
Max thermal resistance per pkg	$R_{\theta JC}$	0.25°C/W Junction to case
Typical thermal resistance	$R_{\theta CS}$	0.08°C/W Case to sink
Terminal Torque		35-40 inch pounds
Mounting base torque - (outside holes)		30-40 inch pounds
Mounting base torque - (center hole)		8-10 inch pounds
center bolt must be torqued first		
Weight		2.8 ounces (75 grams) typical

# UFT200

Figure 1  
Typical Forward Characteristics – Per Leg

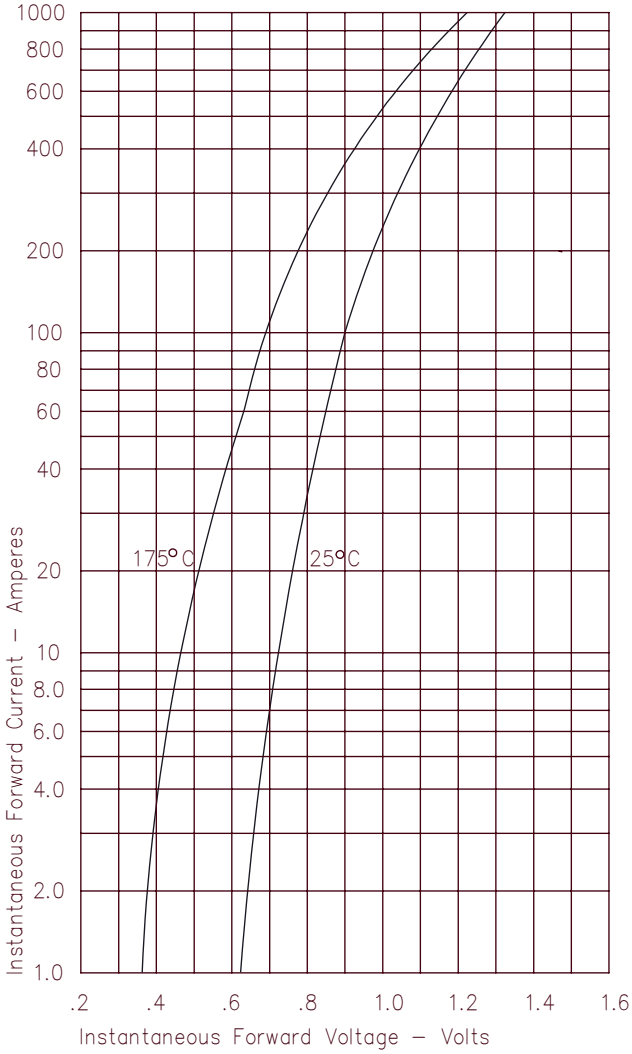

Figure 3  
Typical Junction Capacitance – Per Leg

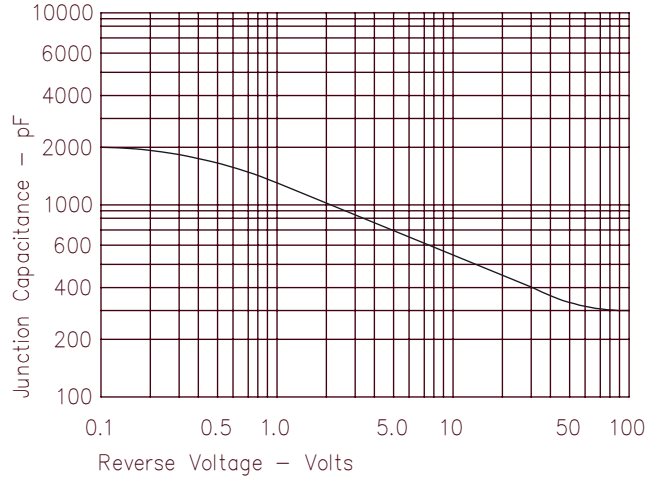

Figure 4  
Forward Current Derating – Per Leg

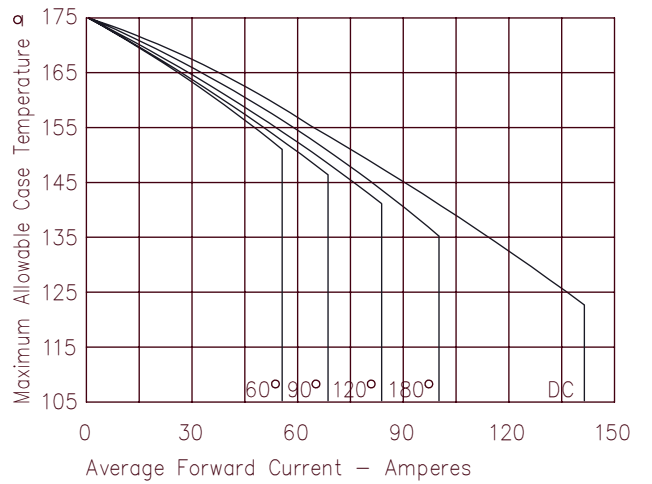

Figure 2  
Typical Reverse Characteristics – Per Leg

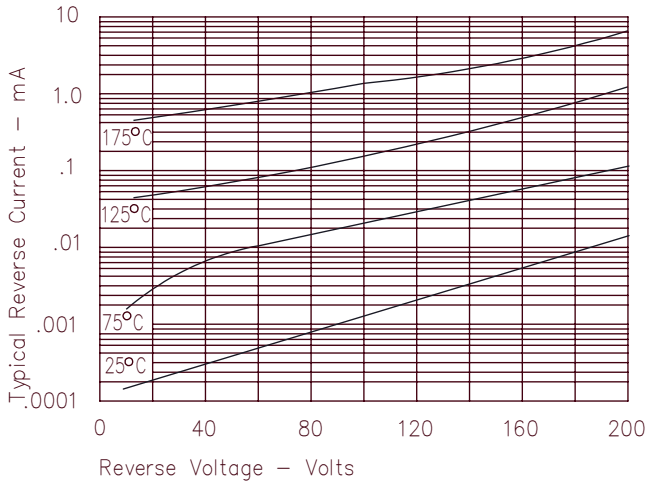
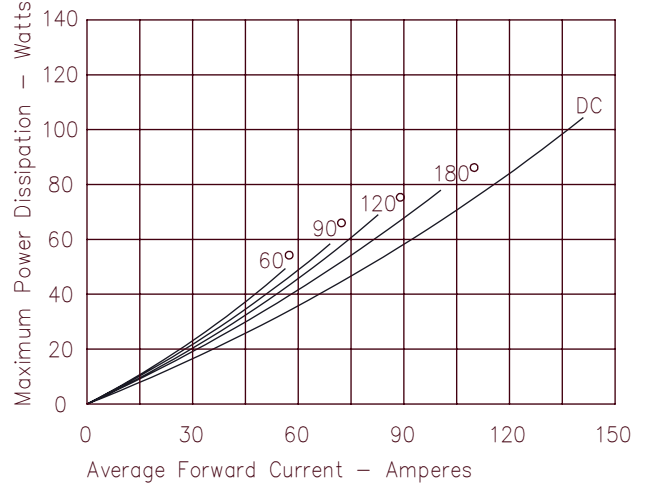

Figure 5  
Maximum Forward Power Dissipation – Per Leg



# UFT201

Figure 1  
Typical Forward Characteristics – Per Leg

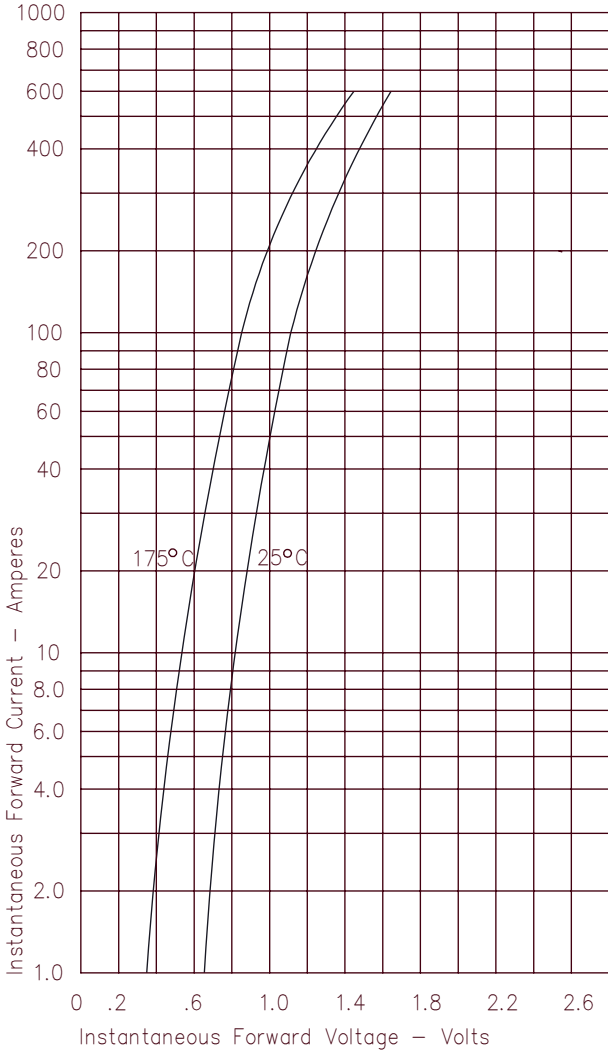

Figure 3  
Typical Junction Capacitance – Per Leg

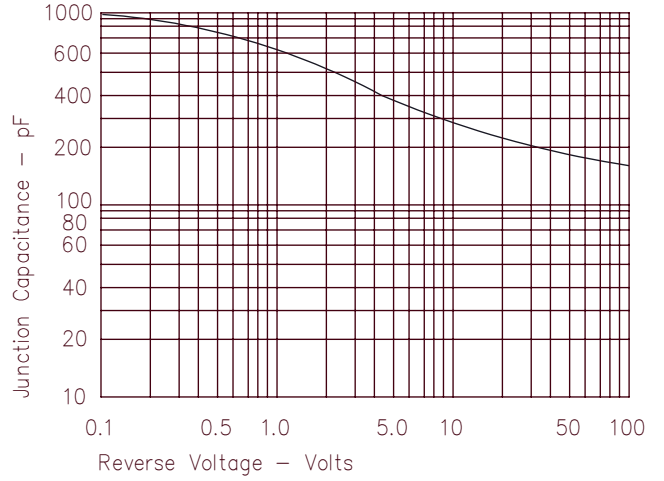

Figure 4  
Forward Current Derating – Per Leg

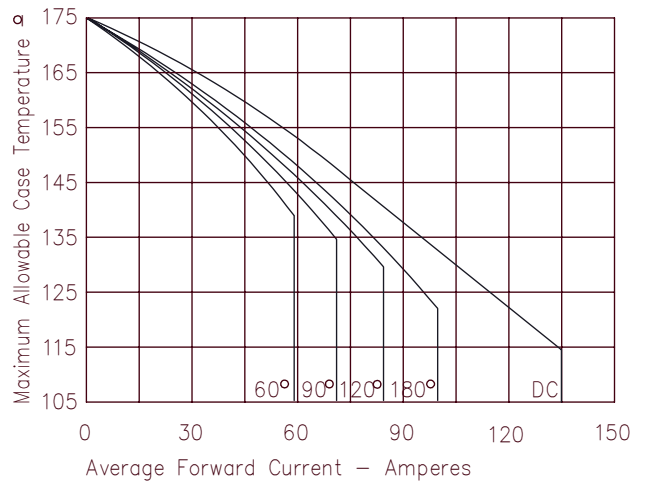

Figure 2  
Typical Reverse Characteristics – Per Leg

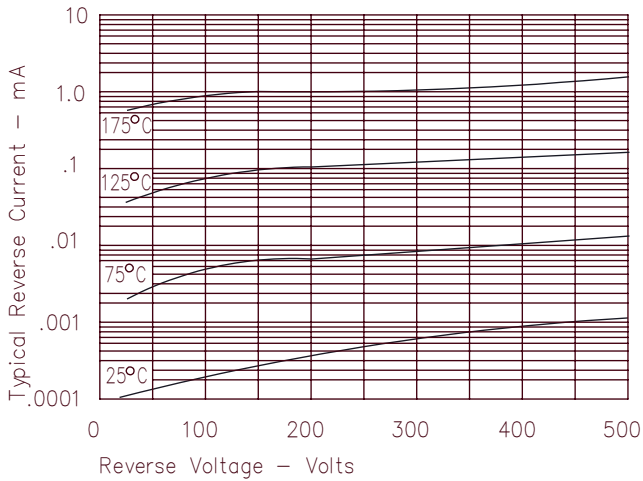
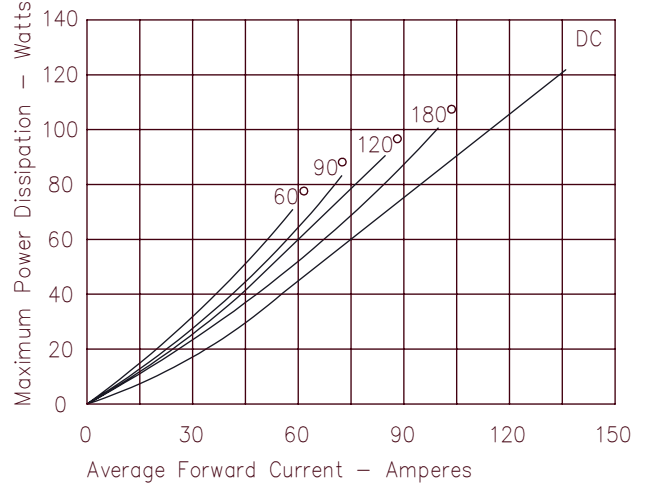

Figure 5  
Maximum Forward Power Dissipation – Per Leg



# UFT202

Figure 1  
Typical Forward Characteristics – Per Leg

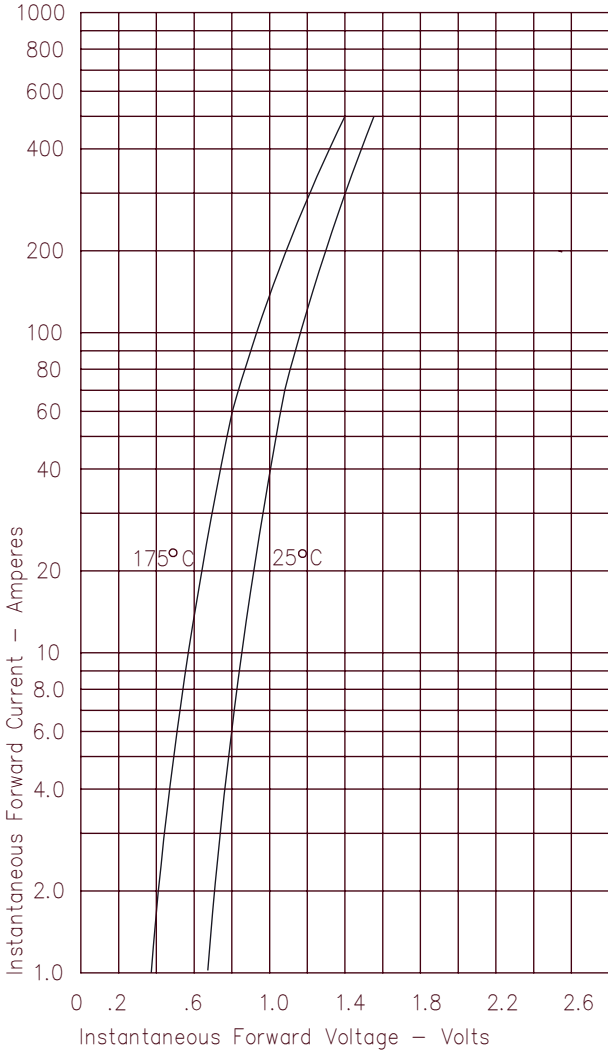

Figure 3  
Typical Junction Capacitance – Per Leg

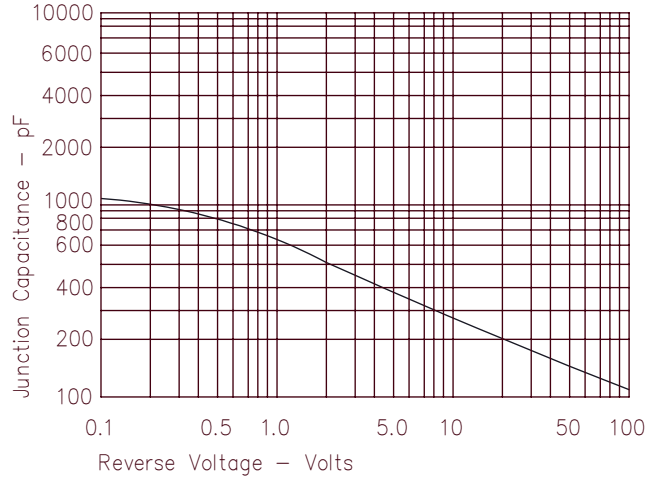

Figure 4  
Forward Current Derating – Per Leg

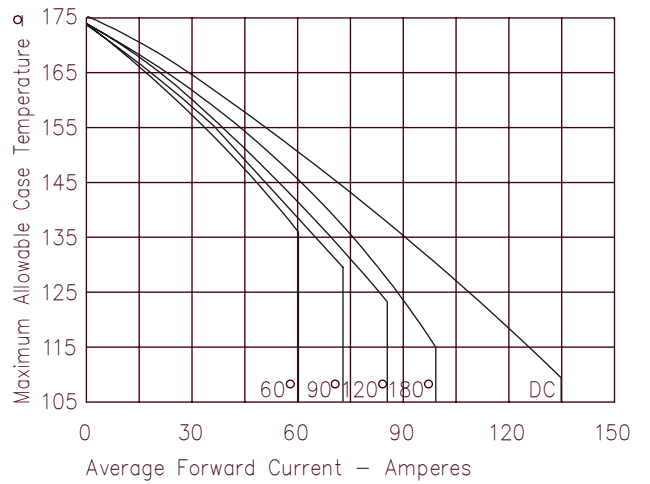

Figure 2  
Typical Reverse Characteristics – Per Leg

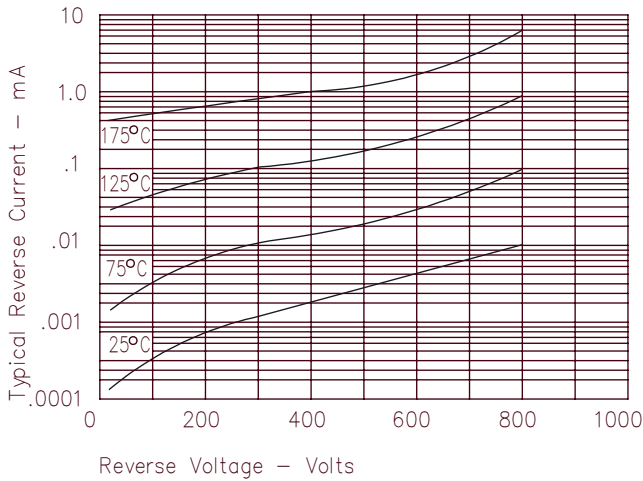
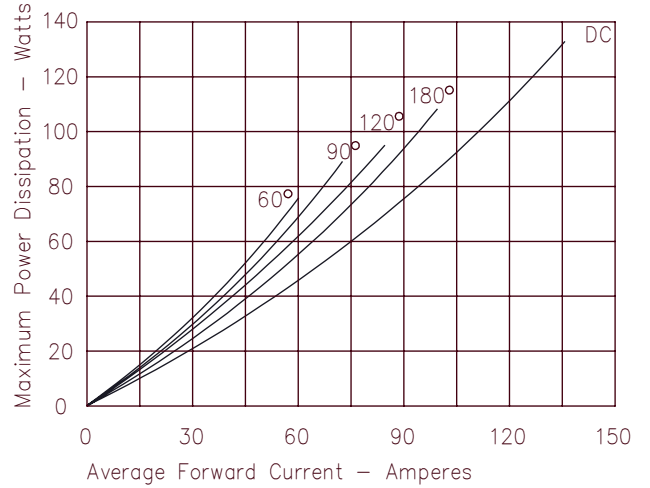

Figure 5  
Maximum Forward Power Dissipation – Per Leg



## DISCLAIMER

The information contained in the document (unless it is publicly available on the Web without access restrictions) is PROPRIETARY AND CONFIDENTIAL information of Microsemi and cannot be copied, published, uploaded, posted, transmitted, distributed or disclosed or used without the express duly signed written consent of Microsemi. If the recipient of this document has entered into a disclosure agreement with Microsemi, then the terms of such Agreement will also apply. This document and the information contained herein may not be modified, by any person other than authorized personnel of Microsemi. No license under any patent, copyright, trade secret or other intellectual property right is granted to or conferred upon you by disclosure or delivery of the information, either expressly, by implication, inducement, estoppels or otherwise. Any license under such intellectual property rights must be approved by Microsemi in writing signed by an officer of Microsemi.

Microsemi reserves the right to change the configuration, functionality and performance of its products at anytime without any notice. This product has been subject to limited testing and should not be used in conjunction with life-support or other mission-critical equipment or applications. Microsemi assumes no liability whatsoever, and Microsemi disclaims any express or implied warranty, relating to sale and/or use of Microsemi products including liability or warranties relating to fitness for a particular purpose, merchantability, or infringement of any patent, copyright or other intellectual property right. Any performance specifications believed to be reliable but are not verified and customer or user must conduct and complete all performance and other testing of this product as well as any user or customers final application. User or customer shall not rely on any data and performance specifications or parameters provided by Microsemi. It is the customer's and user's responsibility to independently determine suitability of any Microsemi product and to test and verify the same. The information contained herein is provided "AS IS, WHERE IS" and with all faults, and the entire risk associated with such information is entirely with the User. Microsemi specifically disclaims any liability of any kind including for consequential, incidental and punitive damages as well as lost profit. The product is subject to other terms and conditions which can be located on the web at <http://www.microsemi.com/legal/tnc.asp>

### Life Support Application

Seller's Products are not designed, intended, or authorized for use as components in systems intended for space, aviation, surgical implant into the body, in other applications intended to support or sustain life, or for any other application in which the failure of the Seller's Product could create a situation where personal injury, death or property damage or loss may occur (collectively "Life Support Applications").

Buyer agrees not to use Products in any Life Support Applications and to the extent it does it shall conduct extensive testing of the Product in such applications and further agrees to indemnify and hold Seller, and its officers, employees, subsidiaries, affiliates, agents, sales representatives and distributors harmless against all claims, costs, damages and expenses, and attorneys' fees and costs arising, directly or indirectly, out of any claims of personal injury, death, damage or otherwise associated with the use of the goods in Life Support Applications, even if such claim includes allegations that Seller was negligent regarding the design or manufacture of the goods.

Buyer must notify Seller in writing before using Seller's Products in Life Support Applications. Seller will study with Buyer alternative solutions to meet Buyer application specification based on Sellers sales conditions applicable for the new proposed specific part.