



Micro Commercial Components

Micro Commercial Components
20736 Marilla Street Chatsworth
CA 91311
Phone: (818) 701-4933
Fax: (818) 701-4939

1N4933GP THRU 1N4937GP

1 Amp Glass Passivated Fast Recovery Rectifier 50 - 600 Volts

Features

- Halogen free available upon request by adding suffix "-HF"
- Glass Passivated Junction
- Low Leakage Current and Fast Switching
- Epoxy meets UL 94 V-0 flammability rating
- Moisture Sensitivity Level 1
- Lead Free Finish/RoHS Compliant (Note1) ("P" Suffix designates Compliant. See ordering information)

Maximum Ratings

- Operating Temperature: -55°C to +150°C
- Storage Temperature: -55°C to +150°C
- Maximum Thermal Resistance; 30°C/W Junction To Lead

MCC Catalog Number	Device Marking	Maximum Recurrent Peak Reverse Voltage	Maximum RMS Voltage	Maximum DC Blocking Voltage
1N4933GP	1N4933GP	50V	35V	50V
1N4934GP	1N4934GP	100V	70V	100V
1N4935GP	1N4935GP	200V	140V	200V
1N4936GP	1N4936GP	400V	280V	400V
1N4937GP	1N4937GP	600V	420V	600V

DO-41

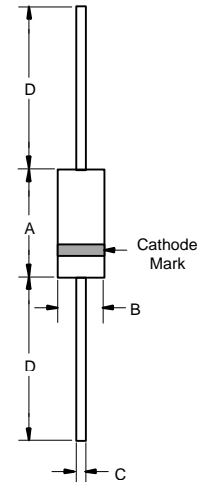

Electrical Characteristics @ 25°C Unless Otherwise Specified

Average Forward Current	$I_{F(AV)}$	1.0A	$T_A = 55^\circ\text{C}$
Peak Forward Surge Current	I_{FSM}	30A	8.3ms, half sine
Maximum Instantaneous Forward Voltage	V_F	1.2V	$I_{FM} = 1.0\text{A}; T_J = 25^\circ\text{C}^*$
Maximum DC Reverse Current At Rated DC Blocking Voltage	I_R	5.0 μA 50 μA 100 μA	$T_J = 25^\circ\text{C}$ $T_J = 100^\circ\text{C}$ $T_J = 125^\circ\text{C}$
Maximum Reverse Recovery Time	T_{rr}	200ns	$I_F = 1.0\text{A}, V_R = 30\text{V}$
Typical Junction Capacitance	C_J	15pF	Measured at 1.0MHz, $V_R = 4.0\text{V}$

*Pulse test: Pulse width 300 μsec , Duty cycle 1%

Note: 1. High Temperature Solder Exemption Applied, see EU Directive Annex 7a

DIM	DIMENSIONS				NOTE
	INCHES		MM		
	MIN	MAX	MIN	MAX	
A	.166	.205	4.10	5.20	
B	.080	.107	2.00	2.70	
C	.028	.034	.70	.90	
D	1.000	---	25.40	---	

Figure 1
Typical Forward Characteristics

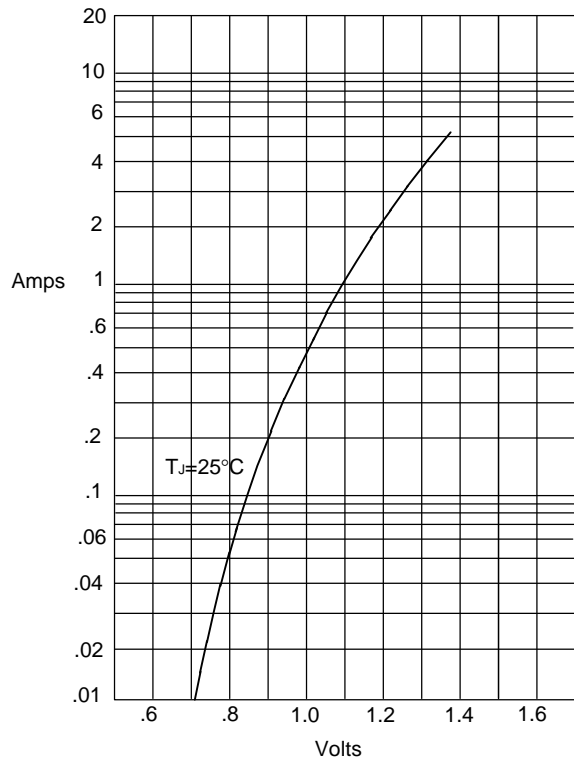

Instantaneous Forward Current - Amperes *versus*
Instantaneous Forward Voltage - Volts

Figure 2
Forward Derating Curve

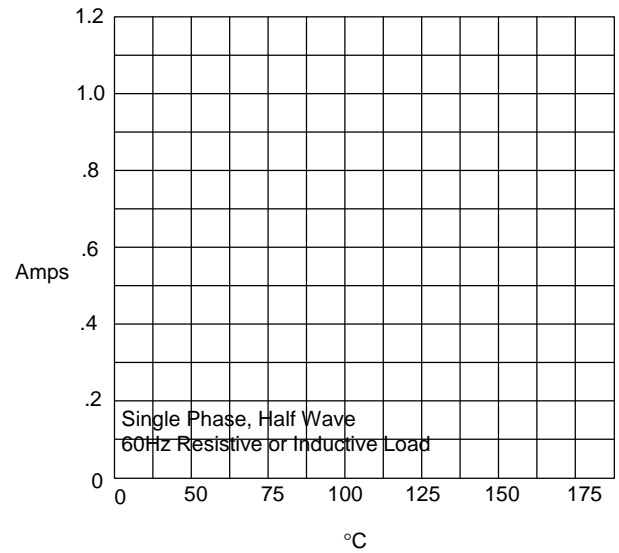

Average Forward Rectified Current - Amperes *versus*
Ambient Temperature - °C

Figure 3
Junction Capacitance

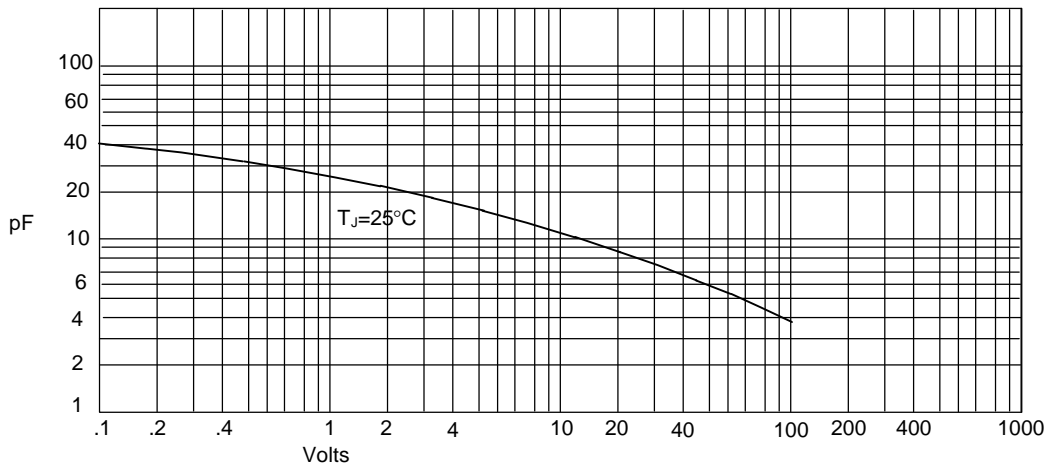

Junction Capacitance - pF *versus*
Reverse Voltage - Volts

Figure 4
Typical Reverse Characteristics

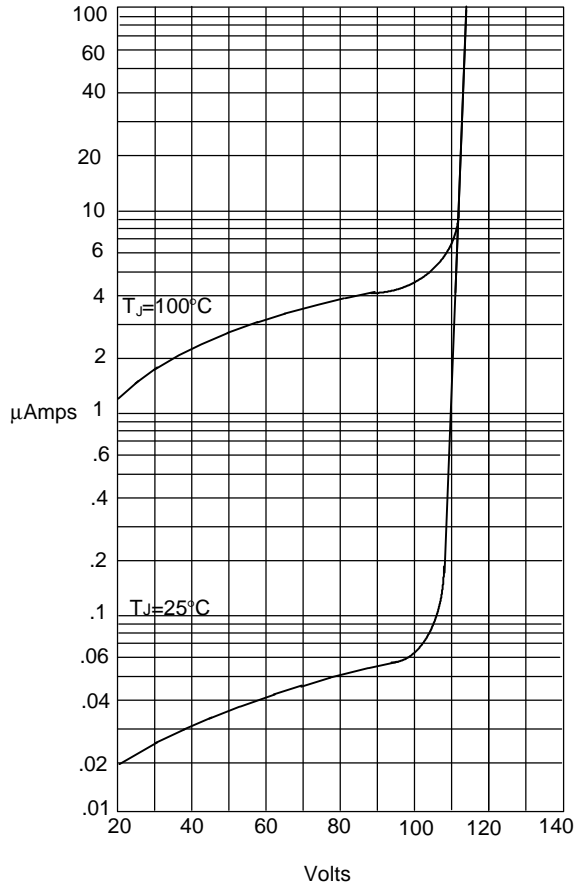

Instantaneous Reverse Leakage Current - MicroAmperes versus
Percent Of Rated Peak Reverse Voltage - Volts

Figure 5
Peak Forward Surge Current

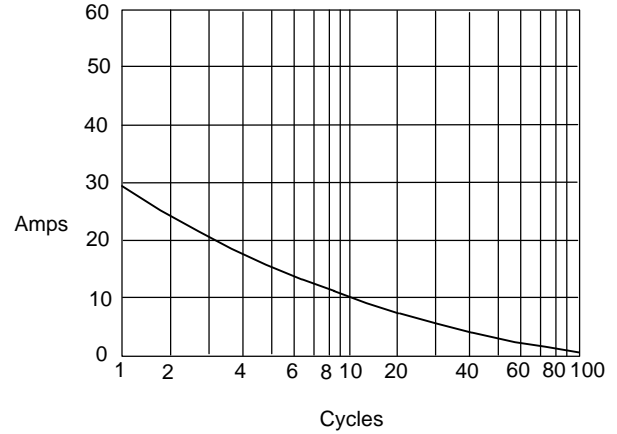

Peak Forward Surge Current - Amperes versus
Number Of Cycles At 60Hz - Cycles

Figure 6
Reverse Recovery Time Characteristic And Test Circuit Diagram

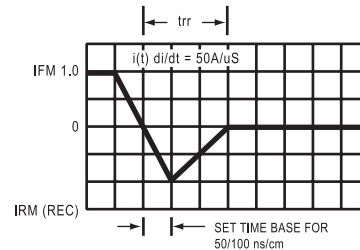
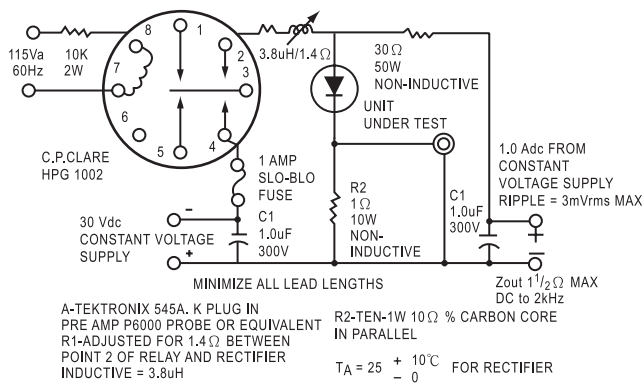



Micro Commercial Components

Ordering Information :

Device	Packing
Part Number-TP	Tape&Reel: 5Kpcs/Reel
Part Number-AP	Ammo Packing: 5Kpcs/Ammo Box
Part Number-BP	Bulk: 50Kpcs/Carton

Note : Adding "-HF" suffix for halogen free, eg. Part Number-TP-HF

IMPORTANT NOTICE

Micro Commercial Components Corp. reserves the right to make changes without further notice to any product herein to make corrections, modifications, enhancements, improvements, or other changes. **Micro Commercial Components Corp.** does not assume any liability arising out of the application or use of any product described herein; neither does it convey any license under its patent rights, nor the rights of others. The user of products in such applications shall assume all risks of such use and will agree to hold **Micro Commercial Components Corp.** and all the companies whose products are represented on our website, harmless against all damages.

LIFE SUPPORT

MCC's products are not authorized for use as critical components in life support devices or systems without the express written approval of Micro Commercial Components Corporation.

CUSTOMER AWARENESS

Counterfeiting of semiconductor parts is a growing problem in the industry. Micro Commercial Components (MCC) is taking strong measures to protect ourselves and our customers from the proliferation of counterfeit parts. MCC strongly encourages customers to purchase MCC parts either directly from MCC or from Authorized MCC Distributors who are listed by country on our web page cited below. Products customers buy either from MCC directly or from Authorized MCC Distributors are genuine parts, have full traceability, meet MCC's quality standards for handling and storage. **MCC will not provide any warranty coverage or other assistance for parts bought from Unauthorized Sources.** MCC is committed to combat this global problem and encourage our customers to do their part in stopping this practice by buying direct or from authorized distributors.