



UM6000 / UM6200/UM6600

POWER PIN DIODES

DESCRIPTION

These series of PIN diodes are designed for applications requiring small package size and moderate average power handling capability. The low capacitance of the UM6000 and UM6600 allows them to be used as series switching elements to 1 GHz. The low resistance of the UM6200 is useful in applications where forward bias current must be minimized.

Because of its thick I-region width and long lifetime the UM6000 and UM6600 have been used in distortion sensitive and high peak power applications, including receiver protectors, TACN, and IFF equipment. Their low capacitance allows them to be useful as attenuator diodes at frequencies greater than 1 GHz. The UM6200 has been

used successfully in switches in which low insertion loss at low bias current is required.

The "A" style package for this series is the smallest Microsemi PIN diode package. It has been used successfully in many microwave applications using coaxial, microstrip, and stripline techniques at frequencies beyond X-Band. The "B" and "E" style leaded packages offer the highest available power dissipation for a package this small. They have been used extensively as series switch elements in microstrip circuits. The "C" style package duplicates the physical outline available in conventional ceramic-metal packages but incorporates the many reliability advantages of the Microsemi construction.

KEY FEATURES

- Voltage ratings to 1000V
- Average power dissipation to 6 W
- Series resistance as low as 0.4 Ω
- Carrier lifetime greater than 1.0 μ s
- Non cavity design
- Thermally matched configuration
- Low capacitance at 0 V bias
- Low conductance at 0 V bias
- Compatible with automatic insertion equipment

IMPORTANT: For the most current data, consult MICROSEMI's website: <http://www.microsemi.com>

ABSOLUTE MAXIMUM RATINGS AT 25° C (UNLESS OTHERWISE SPECIFIED)

Package	Condition	UM6000/UM6600		UM6200	
		PD	θ	PD	θ
A & C	25 °C Pin Temperature	6 W	25 °C/W	4 W	37.5 °C/W
B & E	½ in. total length to 25 °C Contact Free Air	2.5 W	60 °C/W 0.5 W	2.0 W	75 °C/W 0.5 W
SM	25 °C End Cap Temperature	4.5 W	27.5 °C/W	3.0 W	42.5 °C/W
All	1 μ s pulse (Single)	UM6000 25 kW UM6600 13 kW		10 kW	

APPLICATIONS/BENEFITS

- Isolated stud package available
- Surface mount package available
- RoHS compliant packaging available: use UMX6001B, etc.

VOLTAGE RATINGS

Reverse Voltage @ 10 μ A			
100	UM6001	UM6201	UM6601
200	UM6002	UM6202	UM6602
400	-	UM6204	-
800	UM6006	-	UM6606
1000	UM6010	-	UM6610

ELECTRICAL PARAMETERS @ 25°C (unless otherwise specified)

Parameter	Symbol	Conditions	UM6600	UM6000	UM6200	Units
Reverse Current (Max)	I_R	At rated voltage	10	10	10	μA
Series Resistance(Max)	R_S	$I_f = 100 \text{ mA}$, $F = 100 \text{ MHz}$	2.5	1.7	0.4	Ohms
Capacitance (Max)	C_T	$V_R = 100 \text{ V}$, $F = 1 \text{ MHz}$	0.4	0.5	1.1	pF
Parallel Resistance(Min)	R_p	$V_R = 100 \text{ V}$, $F = 100 \text{ MHz}$	300k	300k	350k	Ohms
Carrier Lifetime(Min)	τ	$I_f = 10 \text{ mA}$	1.0	1.0	0.6	us
I-Region Width (Min)	W	-	150	150	40	um

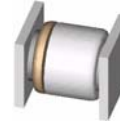

Style "B"

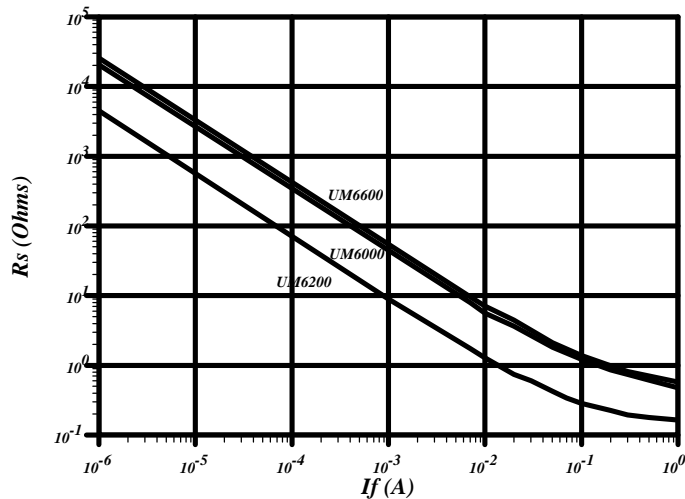
Style "SM"
UM6000/UM6200/UM6600

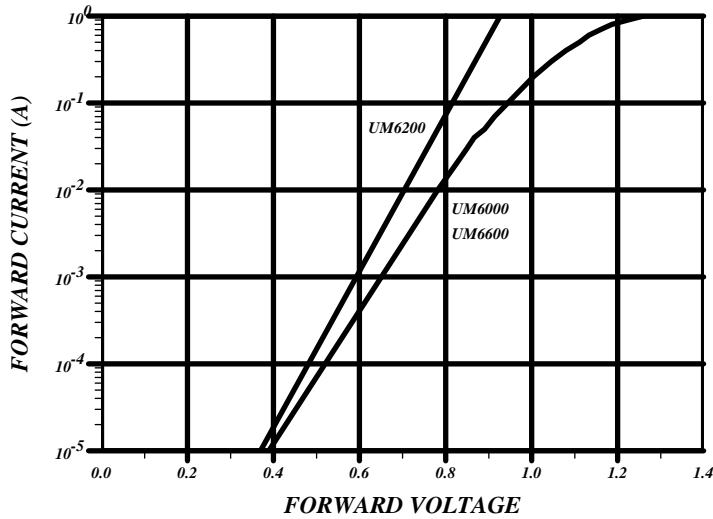
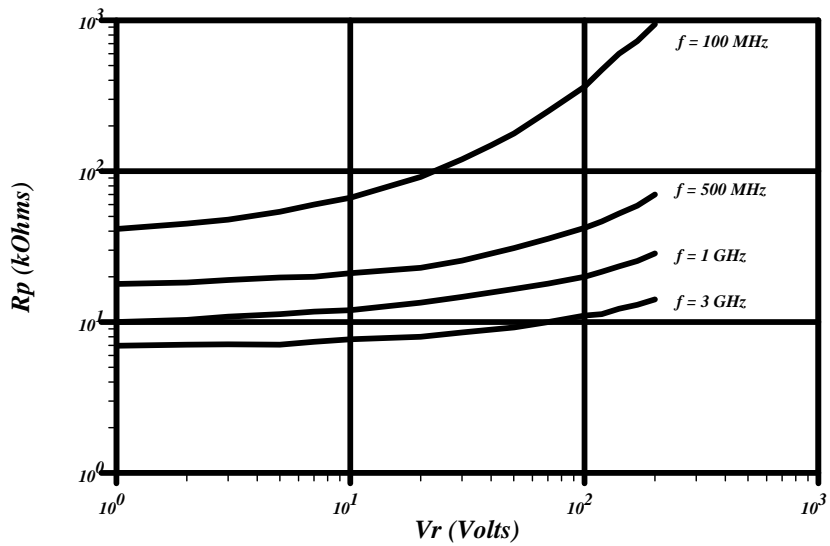
R_s versus I_f
 $f = 100 \text{ MHz}$

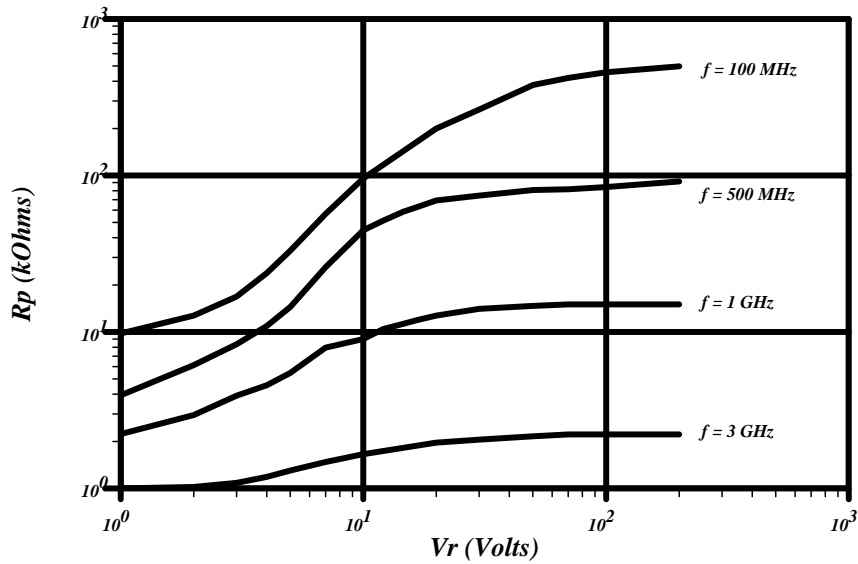
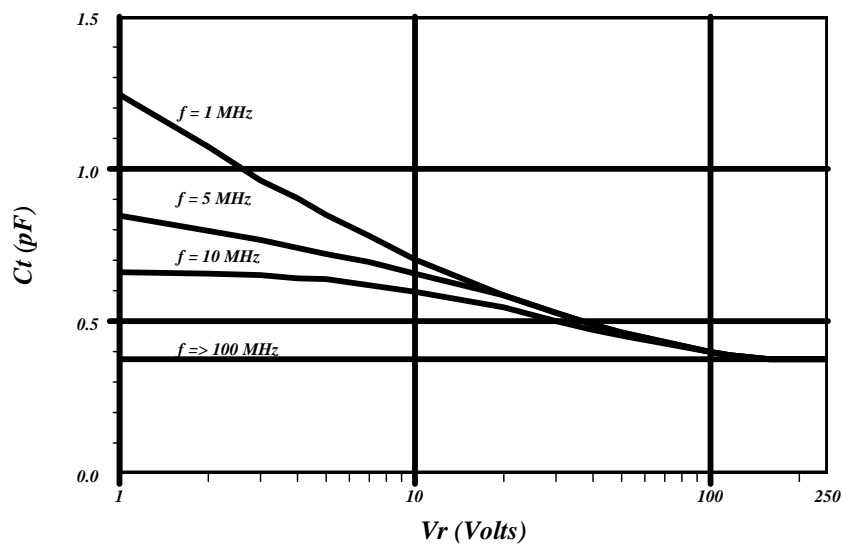

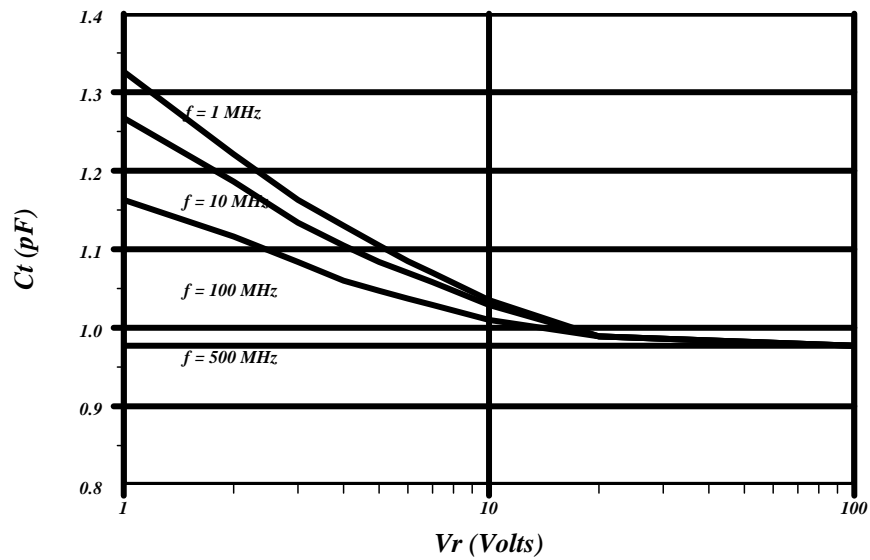
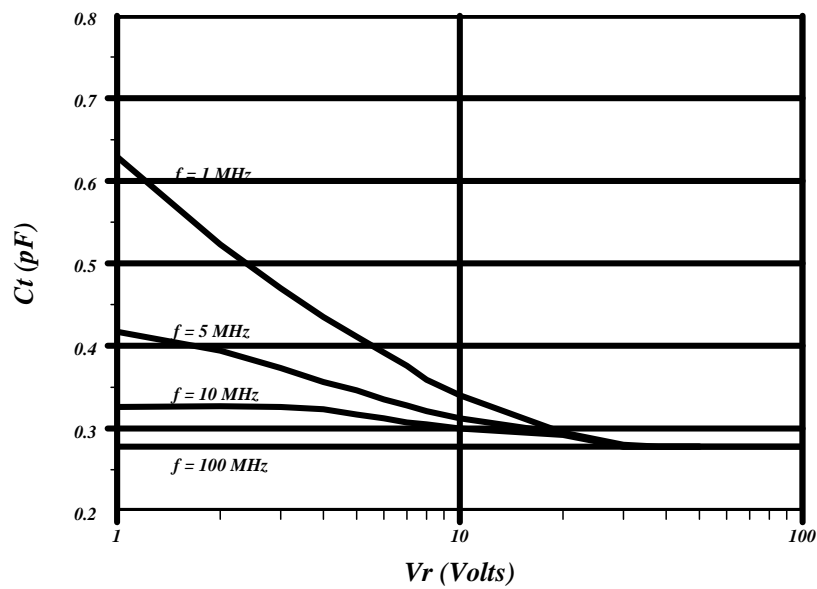
UM6000/UM6200/UM6600
FORWARD VOLTAGE versus CURRENT

UM6000/UM6600
R_p versus V_r

UM6200
R_p versus V_r

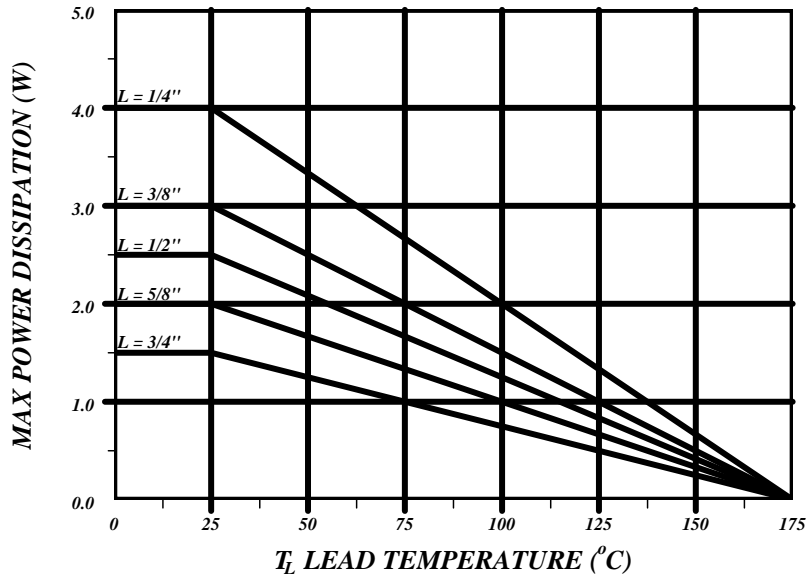
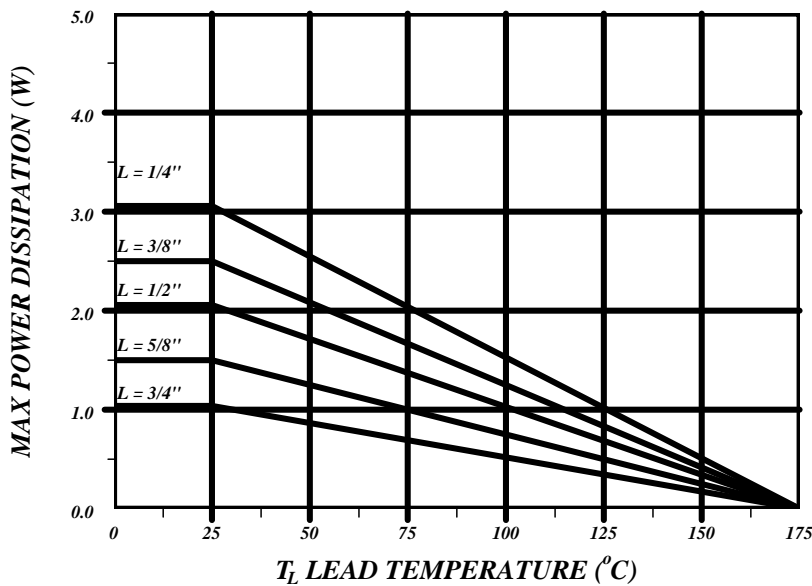
UM6000
C_t versus V_r

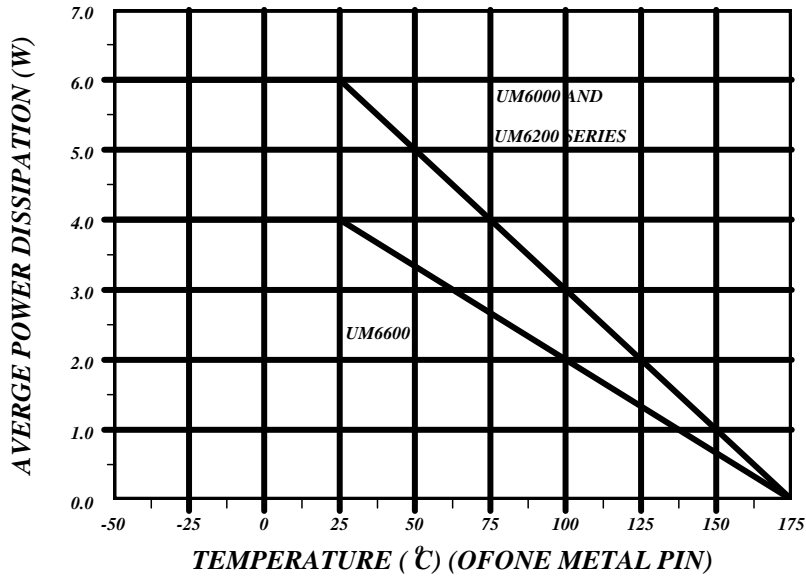
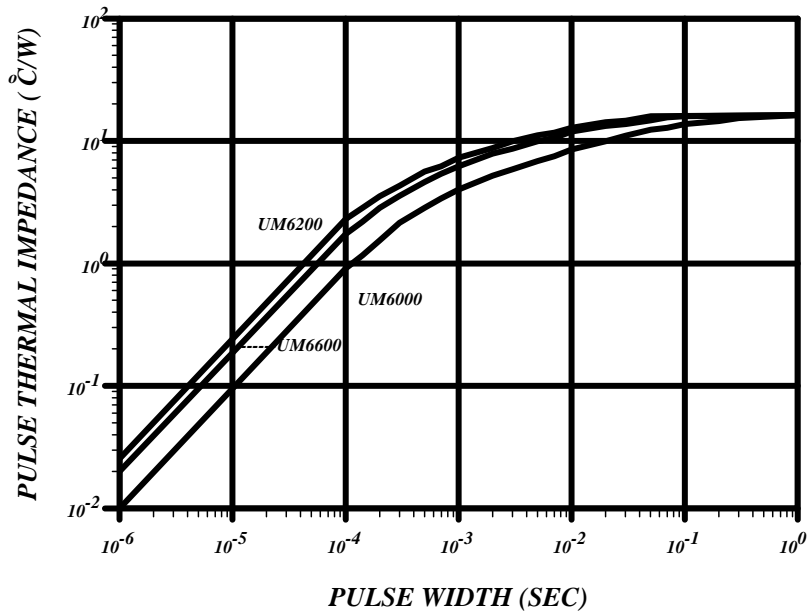
UM6200
C_t versus V_r

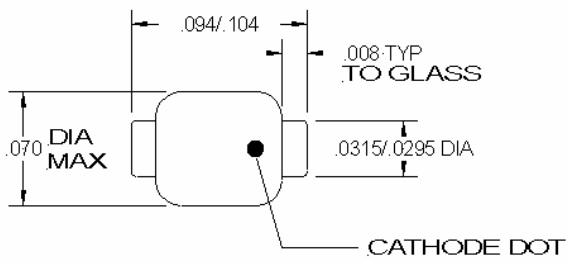
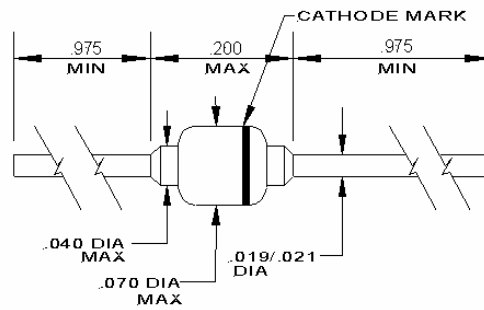
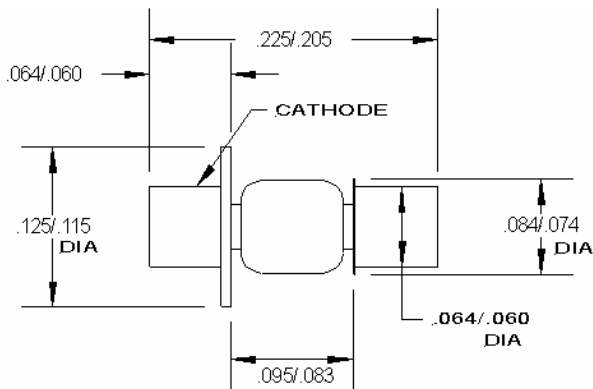
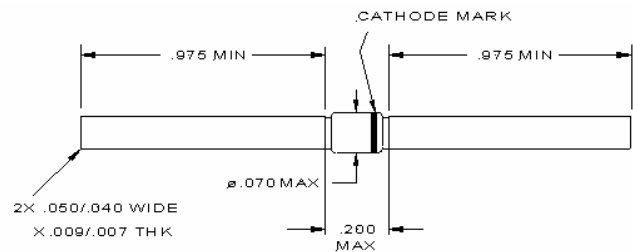
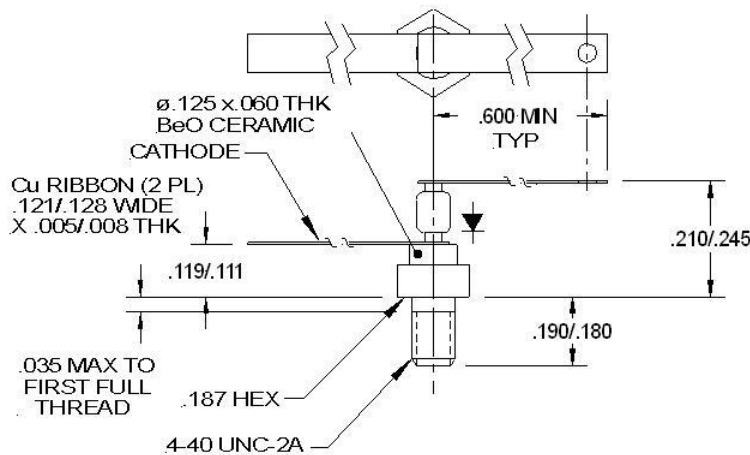
UM6600
C_t versus V_r

UM6000/UM6200
MAX POWER DISSIPATION versus LEAD TEMPERATURE

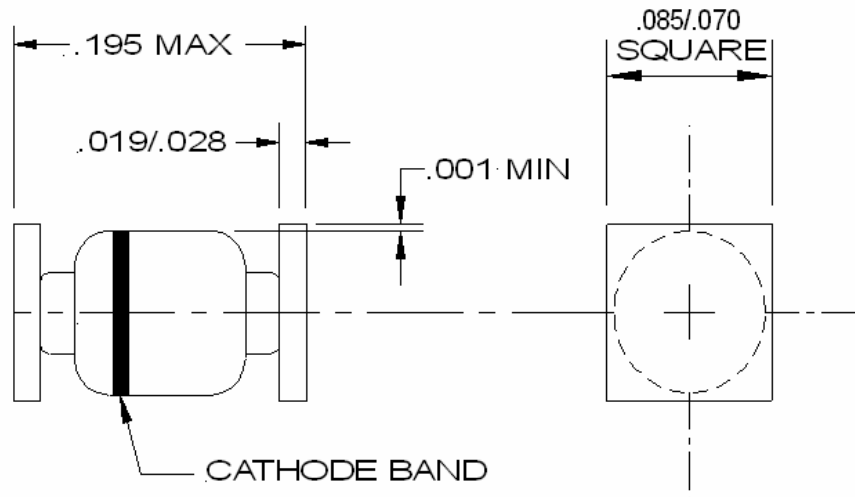
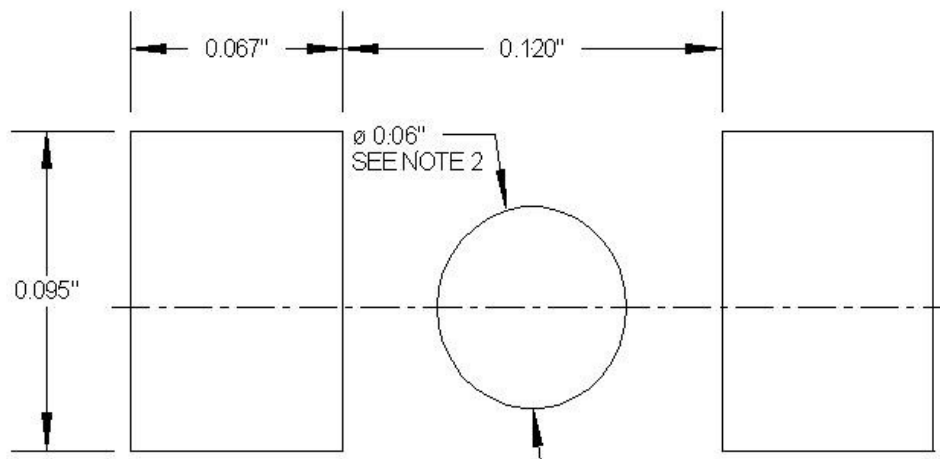
UM6600
MAX POWER DISSIPATION versus LEAD TEMPERATURE

UM6000/UM6200/UM6600
AVERAGE POWER DISSIPATION versus TEMPERATURE

UM6000/UM6200/UM6600
PULSE THERMAL IMPEDANCE VS PULSE WIDTH

STYLE "A"

STYLE "B"

STYLE "C"

STYLE "E"

STYLE "D"

UM6000/UM6200/UM6600

UM6000/UM6200/UM6600 STYLE "SM" FOOTPRINT



UM6000 / UM6200/UM6600

POWER PIN DIODES

NOTES:

1. These dimensions will match the terminals and provide for additional solder fillets at the outboard ends at least as wide as the terminals themselves, assuming accuracy of placement within 0.005"
2. If the mounting method chosen requires use of an adhesive separate from the solder compound, a round (or square) spot of cement as shown should be centrally located.

NOTES: