

MR1238 series

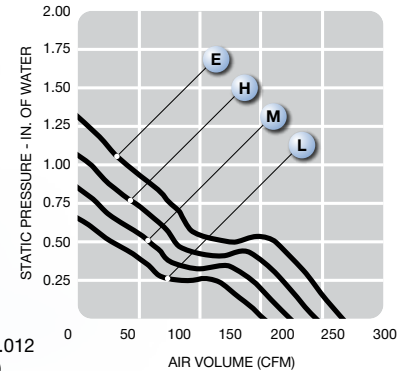
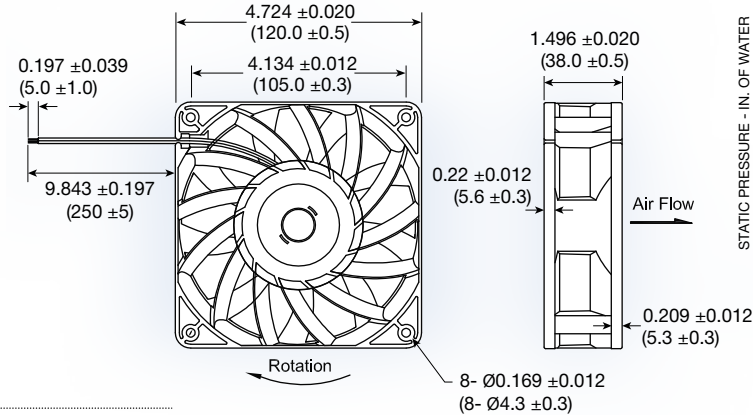

(120 x 120 x 38 mm)

4.72 x 4.72 x 1.49 inches

Features: soft start, polarity protection, auto-restart

Operating Voltage: 12, 24 or 48 VDC

Construction: UL94V-0 plastic impeller and frame

Bearing option: ball bearing

Air Flow: air exhaust over struts

Options: tachometer output or locked rotor alarm signal; PWM speed control

Model No.	Rated Voltage VDC	Current A			Speed RPM	Air Volume		Max. Static Pressure (H ₂ O)		Sound Noise dbA	Weight g
		12	24	48		M ³ /Min.	CFM	MM	INCH		
MR1238L	12/24/48	1.30	0.65	0.32	3,500	5.20	184	16.66	0.66	58.5	380
MR1238M	12/24/48	1.86	0.93	0.46	4,000	5.92	210	21.53	0.85	31.7	380
MR1238H	12/24/48	2.60	1.30	0.65	4,500	6.64	235	27.20	1.07	64.6	380
MR1238E	12/24/48	-	1.90	0.95	5,000	7.37	261	33.42	1.32	67.9	380