



■ Features

- Universal AC input / Full range
- 3 pole AC inlet IEC320-C14, Class I power unit
- No load power consumption < 0.075W
- **Energy efficiency Level VI**
- Comply with EISA 2007/DoE, EU ErP and meet CoC Version 5
- Protections: Short circuit / Overload / Over voltage
- Fully enclosed plastic case
- Pass LPS
- Various DC plug quick adapter accessory available
(Plug kit sold sperately, please refer to : https://www.meanwell.com/upload/pdf/DC_plug.pdf)
- 2 years warranty

■ Applications

- Consumer electronic devices
- Telecommunication devices
- Office facilities
- Industrial equipments

■ Description

GS15A is a highly reliable, 15W desktop style single-output green adaptor series. This product is a class I power unit (with FG), equipped with a standard IEC320-C14 AC inlet and adopting the input range from 90VAC to 264VAC. The entire series supplies different models with output voltages ranging between 5VDC and 48VDC that can satisfy the demands for various types of consumer electronic devices.

With the efficiency up to 87% and the extremely low no-load power consumption below 0.075W, GS15A is compliant with USA EISA 2007/DoE, EU ErP, and meet Code of Conduct(CoC) Version 5. The supreme feature allows the adaptor to save the energy when it is either under the operating mode or the standby mode.

The entire series utilizes the 94V-0 flame retardant plastic case. GS15A is certified for the international safety regulations.

■ Model Encoding

GS 15 A - 1 P1J

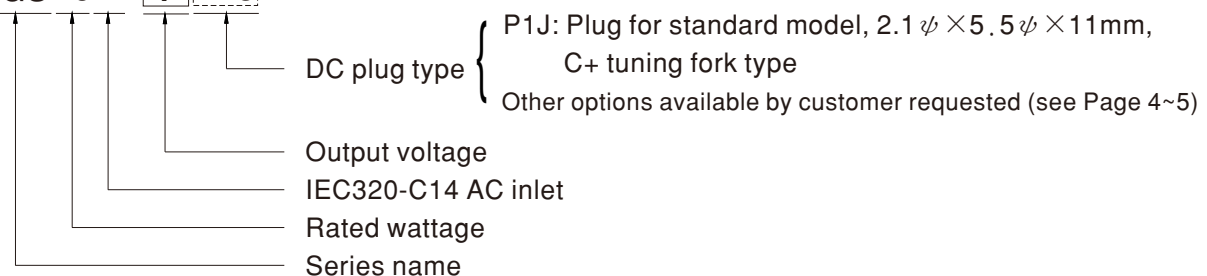



SPECIFICATION

| ORDER NO. | GS15A-1P1J | GS15A-11P1J | GS15A-2P1J | GS15A-3P1J | GS15A-4P1J | GS15A-5P1J | GS15A-6P1J | GS15A-8P1J | | |
|--------------------------------------|--|---|--|------------|------------|------------|--|--|-----------|--|
| OUTPUT | SAFETY MODEL NO. | GS15A-1 | GS15A-1-1 | GS15A-2 | GS15A-3 | GS15A-4 | GS15A-5 | GS15A-6 | GS15A-8 | |
| | DC VOLTAGE Note.2 | 5V | 7.5V | 9V | 12V | 15V | 18V | 24V | 48V | |
| | RATED CURRENT | 2.40A | 1.60A | 1.66A | 1.25A | 1.00A | 0.83A | 0.625A | 0.31A | |
| | CURRENT RANGE | 0 ~ 2.40A | 0 ~ 1.60A | 0 ~ 1.66A | 0 ~ 1.25A | 0 ~ 1.00A | 0 ~ 0.83A | 0 ~ 0.625A | 0 ~ 0.31A | |
| | RATED POWER | 12W | 12W | 15W | 15W | 15W | 15W | 15W | 15W | |
| | RIPPLE & NOISE (max.) Note.3 | 50mVp-p | 80mVp-p | 80mVp-p | 80mVp-p | 100mVp-p | 120mVp-p | 150mVp-p | 240mVp-p | |
| | VOLTAGE TOLERANCE Note.4 | ±5.0% | ±5.0% | ±5.0% | ±3.0% | ±3.0% | ±3.0% | ±2.0% | ±2.0% | |
| | LINE REGULATION Note.5 | ±0.5% | ±0.5% | ±0.5% | ±0.5% | ±0.5% | ±0.5% | ±0.5% | ±0.5% | |
| | LOAD REGULATION Note.6 | ±5.0% | ±5.0% | ±5.0% | ±3.0% | ±3.0% | ±3.0% | ±2.0% | ±2.0% | |
| | SETUP, RISE, HOLD UP TIME | 3000ms, 50ms, 16ms at full load | | | | | | | | |
| INPUT | VOLTAGE RANGE | 90 ~ 264VAC 135 ~ 370VDC | | | | | | | | |
| | FREQUENCY RANGE | 47 ~ 63Hz | | | | | | | | |
| | EFFICIENCY (Typ.) | 80% | 82.5% | 85% | 85% | 85% | 85% | 85.5% | 87% | |
| | AC CURRENT | 0.5A / 100VAC | | | | | | | | |
| | INRUSH CURRENT (max.) | Cold start 30A/ 115VAC 50A / 230VAC | | | | | | | | |
| | LEAKAGE CURRENT(max.) | 0.25mA / 240VAC | | | | | | | | |
| PROTECTION | OVERLOAD | 105 ~ 250% rated output power Protection type : Hiccup mode, recovers automatically after fault condition is removed | | | | | | | | |
| | OVER VOLTAGE | >120% rated output voltage Protection type : Clamp by zener diode | | | | | | | | |
| ENVIRONMENT | WORKING TEMP. | 0 ~ +50°C (Refer to "Derating Curve") | | | | | | | | |
| | WORKING HUMIDITY | 20% ~ 90% RH non-condensing | | | | | | | | |
| | STORAGE TEMP., HUMIDITY | -20 ~ +85°C, 10 ~ 95% RH non-condensing | | | | | | | | |
| | TEMP. COEFFICIENT | ±0.03% / °C (0 ~ 40°C) | | | | | | | | |
| | VIBRATION | 10 ~ 500Hz, 2G 10min./1cycle, period for 60min. each along X, Y, Z axes | | | | | | | | |
| SAFETY & EMC (Note. 7) | SAFETY STANDARDS | UL62368-1, CSA C22.2 NO. 62368-1, TUV EN62368-1, EAC TP TC 004 approved | | | | | | | | |
| | WITHSTAND VOLTAGE | I/P-O/P:3KVAC, I/P-FG:1.5KVAC | | | | | | | | |
| | ISOLATION RESISTANCE | I/P-O/P, I/P-FG:100M Ohms / 500VDC / 25°C / 70% RH | | | | | | | | |
| | EMC EMISSION | Parameter | Standard | | | | | Test Level / Note | | |
| | | Conducted emission | EN55032(CISPR32)/FCC PART 15 / CISPR22, CAN ICES-3(B)/NMB-3(B) | | | | | Class B | | |
| | | Radiated emission | EN55032(CISPR32)/FCC PART 15 / CISPR22, CAN ICES-3(B)/NMB-3(B) | | | | | Class B | | |
| | | Harmonic current | EN61000-3-2 | | | | | Class A | | |
| | | Voltage flicker | EN61000-3-3 | | | | | ----- | | |
| | EMC IMMUNITY | Parameter | Standard | | | | | Test Level / Note | | |
| | | ESD | EN61000-4-2 | | | | | Level 3, 8KV air; Level 2, 4KV contact | | |
| | | RF field susceptibility | EN61000-4-3 | | | | | Level 2, 3V/m | | |
| | | EFT bursts | EN61000-4-4 | | | | | Level 2, 1KV | | |
| | | Surge susceptibility | EN61000-4-5 | | | | | Level 3, 1KV/L-N 2KV/L,N-PE | | |
| | | Conducted susceptibility | EN61000-4-6 | | | | | Level 2, 3V | | |
| | | Magnetic field immunity | EN61000-4-8 | | | | | Level 1, 1A/m | | |
| Voltage dips, interruption | | EN61000-4-11 | | | | | >95% dip 0. 5 periods, 30% dip 25 periods, >95% interruptions 250 periods | | | |
| OTHERS | MTBF | 500Khrs min. MIL-HDBK-217F(25°C) | | | | | | | | |
| | DIMENSION | 100*58.5*32.8mm (L*W*H) | | | | | | | | |
| | PACKING | 190g ; 90pcs / 18Kg / CARTON | | | | | | | | |
| CONNECTOR | PLUG | See page 4~5 ; Other type available by customer requested | | | | | | | | |
| | CABLE | See page 4~5 ; Other type available by customer requested | | | | | | | | |
| NOTE | <p>1.All parameters are specified at 230VAC input, rated load, 25°C 70% RH ambient.</p> <p>2.DC voltage: The output voltage set at point measure by plug terminal & 50% load.</p> <p>3.Ripple & noise are measured at 20MHz by using a 12" twisted pair terminated with a 0.1µf & 47µf capacitor.</p> <p>4.Tolerance: includes set up tolerance, line regulation, load regulation.</p> <p>5.Line regulation is measured from low line to high line at rated load.</p> <p>6.Load regulation is measured from 0% to 100% rated load.</p> <p>7.The power supply is considered as an independent unit, but the final equipment still need to re-confirm that the whole system complies with the EMC directives. For guidance on how to perform these EMC tests, please refer to "EMI testing of component power supplies." (as available on http://www.meanwell.com)</p> | | | | | | | | | |

Derating Curve

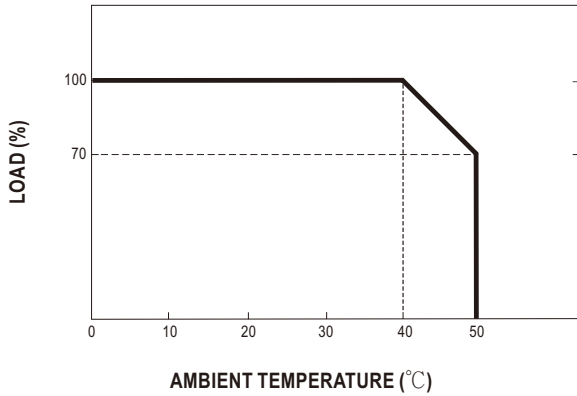

Static Characteristics

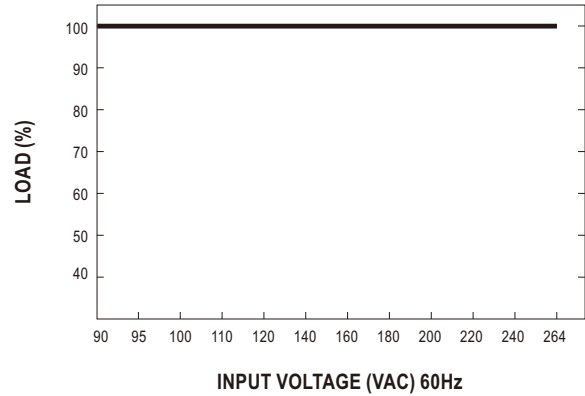

Mechanical Specification

Unit:mm

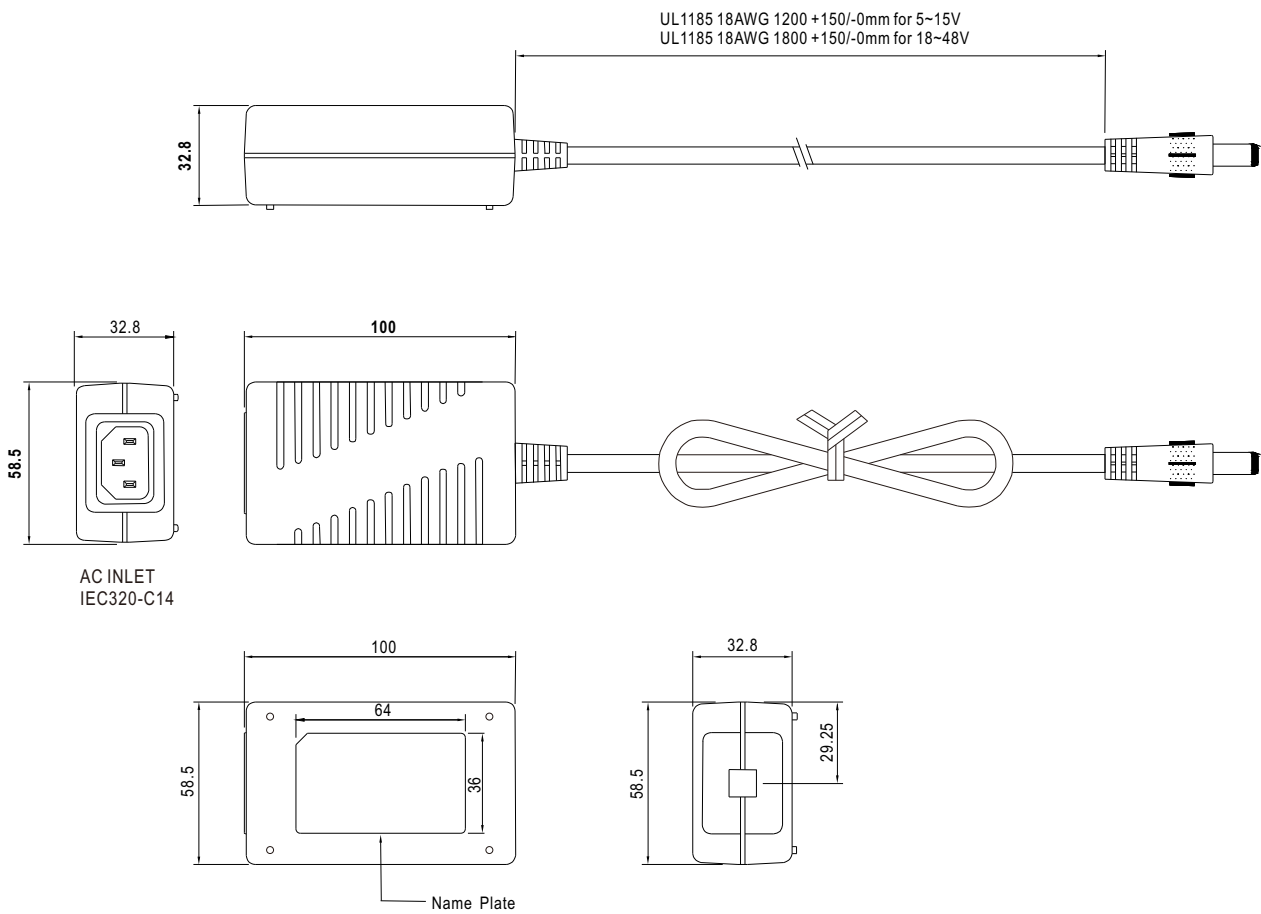

■ DC output plug

◎ Standard plug: P1J

Unit:mm

| P1J | Pin Assignment |
|-----|-----------------|
| | |
| | Outside Inside |

◎ DC plug changeable through:

- (1) Customization of the standard part with an optional DC plug according to the table (MOQ applicable)
- (2) Quick adapter accessory (sold separately without MOQ)



Please refer to below table and online selection guide : https://www.meanwell.com/upload/pdf/DC_plug.pdf

Example quick adapter accessory:

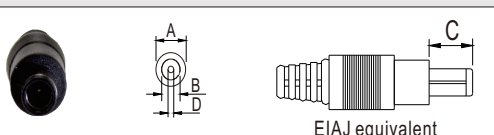
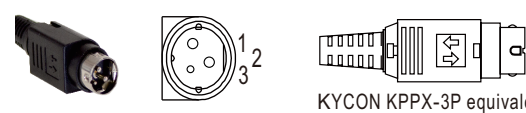
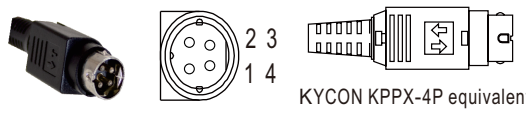

◎ Optional DC plug: (Available in customized cable or quick adapter)

| Tuning Fork Style | | Type No. | A | B | C | Quick Adapter Accessory |
|-------------------|--|------------|------|------|-------|--|
| | | | OD | ID | L | |
| | | P1I | 5.5 | 2.1 | 9.5 | Available (Current rating: 7.5A max.) |
| | | P1L | 5.5 | 2.5 | 9.5 | |
| | | P1M | 5.5 | 2.5 | 11.0 | |
| | | P1IR | 5.5 | 2.1 | 9.5 | |
| | | P1JR | 5.5 | 2.1 | 11.0 | |
| | | P1LR | 5.5 | 2.5 | 9.5 | |
| | | P1MR | 5.5 | 2.5 | 11.0 | |
| Barrel Style | | Type No. | A | B | C | Quick Adapter Accessory |
| | | | OD | ID | L | |
| | | P2I | 5.5 | 2.1 | 9.5 | None |
| | | P2J | 5.5 | 2.1 | 11.0 | |
| | | P2L | 5.5 | 2.5 | 9.5 | |
| | | P2M | 5.5 | 2.5 | 11.0 | |
| | | P2IR | 5.5 | 2.1 | 9.5 | |
| | | P2JR | 5.5 | 2.1 | 11.0 | |
| | | P2LR | 5.5 | 2.5 | 9.5 | |
| | | P2MR | 5.5 | 2.5 | 11.0 | |
| Lock Style | | Type No. | A | B | C | Quick Adapter Accessory |
| | | | OD | ID | L | |
| | | P2S(S761K) | 5.53 | 2.03 | 12.06 | None |
| | | P2K(761K) | 5.53 | 2.54 | 12.06 | |
| | | P2C(S760K) | 5.53 | 2.03 | 9.52 | |
| | | P2D(760K) | 5.53 | 2.54 | 9.52 | |
| Min. Pin Style | | Type No. | A | B | C | Quick Adapter Accessory |
| | | | OD | ID | L | |
| | | P3A | 2.35 | 0.7 | 11.0 | Available (Current rating: 5A max.) |
| | | P3B | 4.0 | 1.7 | 11.0 | |
| | | P3C | 4.75 | 1.7 | 11.0 | |

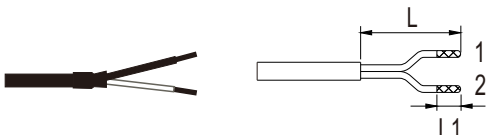
| Center Pin Style | Type No. | A | B | C | D | Quick Adapter Accessory |
|---|-------------|----------------|--------|------|------------|--|
| | | OD | ID | L | Center Pin | |
|  <p>EIAJ equivalent</p> | P4A | 5.5 | 3.4 | 11.0 | 1.0 | Available (Current rating: 7.5A max.) |
| | P4B | 6.5 | 4.4 | 11.0 | 1.4 | |
| | P4C | 7.4 | 5.1 | 11.0 | 0.6 | |
| Min. DIN 3 Pin with Lock (male) | Type No. | Pin Assignment | | | | |
|  <p>KYCON KPPX-3P equivalent</p> | R6B | PIN No. | Output | | | |
| | | 1 | +Vo | | | |
| | | 2 | -Vo | | | |
| | | 3 | +Vo | | | |
| Min. DIN 4 Pin with Lock (male) | Type No. | Pin Assignment | | | | |
|  <p>KYCON KPPX-4P equivalent</p> | R7B | PIN No. | Output | | | |
| | | 1 | +Vo | | | |
| | | 2 | -Vo | | | |
| | | 3 | -Vo | | | |
| | | 4 | +Vo | | | |
| Min. DIN 4 Pin with Lock (female) | Type No. | Pin Assignment | | | | |
|  <p>KYCON KPJX-CM-4S equivalent</p> | R7BF | PIN No. | Output | | | |
| | | 1 | +Vo | | | |
| | | 2 | -Vo | | | |
| | | 3 | -Vo | | | |
| | | 4 | +Vo | | | |
| Stripped and tinned leads | Type No. | Pin Assignment | | | | |
|  <p>Length of Land L1 by request (MW's standard length, L: 25 mm, L1: 10 mm)</p> | by customer | PIN No. | Output | | | |
| | | 1 (White) | +Vo | | | |
| | | 2 (Black) | -Vo | | | |

Installation Manual

Please refer to : <http://www.meanwell.com/manual.html>