

Complete Bias and White LED Power Supplies for Small TFT Displays

General Description

The MAX1578/MAX1579 provide four regulated outputs to meet all the voltage requirements for small active-matrix TFT-LCD displays in handheld devices where minimum external components and high efficiency are required. Each device consists of three advanced charge pumps for LCD bias power and a step-up converter for driving up to 8 series white LEDs for backlighting. The input voltage range is from 2.7V to 5.5V.

The charge pumps provide fixed +5V, +15V, and -10V for the LCD bias circuits. No external diodes are needed. A high-efficiency, fractional (1.5x/2x) charge pump followed by a low-dropout linear regulator provides +5V to power the source driver. Automatic mode changing achieves the highest conversion efficiency. Two multistage, high-voltage charge pumps generate +15V and -10V to provide V_{ON} and V_{OFF}, respectively. Utilizing a unique clocking scheme and internal drivers, these charge pumps eliminate parasitic charge-current glitches and reduce maximum input current, resulting in low electromagnetic emissions. The outputs are sequenced during startup and shutdown. In shutdown, the outputs are discharged to zero.

The high-efficiency inductor step-up converter drives up to 8 white LEDs in series with a constant current to provide backlighting. The series connection allows the LED currents to be identical for uniform brightness and minimizes the number of traces to the LEDs. The MAX1578 regulates constant LED current over the entire temperature range. The MAX1579 features a temperature derating function to avoid overdriving the white LEDs during high ambient temperatures, enabling higher drive current below +42°C.

The MAX1578/MAX1579 are available in space-saving 24-lead 4mm x 4mm thin QFN packages.

Applications

PDA's, Palmtops	LCD Displays with
Smart Phones	White LED Backlight
Internet Appliances	

Ordering Information

PART	TEMP RANGE	PIN-PACKAGE
MAX1578ETG	-40°C to +85°C	24 Thin QFN 4mm x 4mm (T2444-4)
MAX1578ETG+	-40°C to +85°C	24 Thin QFN 4mm x 4mm (T2444-4)

+ Denotes lead-free package.

Ordering Information continued at end of data sheet.

MAXIM

Features

- ◆ Four Regulators in One Package
- ◆ Bias Power Using Charge Pumps
 - +5V at 25mA for Source Driver
 - +15V at 100µA for V_{ON}
 - 10V at 100µA for V_{OFF}
 - No External Diodes Required
 - Output Sequencing
 - POS, NEG, and MAIN Are Autodischarged During Shutdown
- ◆ LED Backlight Power Using Boost Converter
 - Series LED Connection for Uniform Illumination
 - Supports Up to 8 LEDs at 25mA (max)
 - 900mW (max) Power
 - PWM or Analog Dimming Control
 - Overvoltage Protection
 - Low Input/Output Ripple
 - Soft-Start with Zero Inrush Current
 - Fast 1MHz PWM Operation for Small Component Size
 - Temperature Derating Function (MAX1579)
- ◆ High Efficiency
 - Bias: 83% (5.0V at 25mA, 15V/-10V at 100µA)
 - LED: 84% (6 LEDs at 20mA)
- ◆ Uses Only Ceramic Capacitors and Only One Inductor
- ◆ Independent Enable Inputs for LED and Bias Power
- ◆ Thermal-Shutdown Protection
- ◆ 1µA Shutdown Current
- ◆ Tiny 4mm x 4mm Thin QFN Package

Pin Configuration

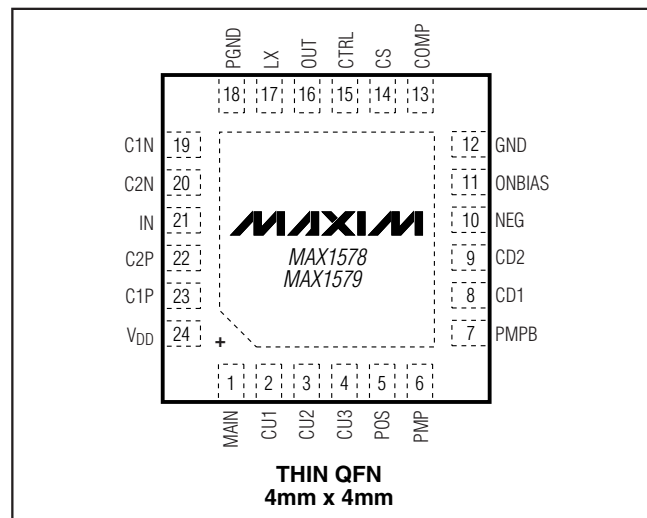

See Figure 3 for Typical Application Circuit.

Complete Bias and White LED Power Supplies for Small TFT Displays

ABSOLUTE MAXIMUM RATINGS

IN, CS, C1N, C2N, MAIN, ONBIAS, V_{DD} to GND.....-0.3V to +6V
 CTRL to GND.....-0.3V to the lesser of +6V or (V_{IN} + 2V)
 LX, OUT to GND.....-0.3V to +37V
 COMP to GND.....-0.3V to (V_{IN} + 0.3V)
 CU1 to MAIN.....-0.3V to +6V
 CU2 to CU1.....-0.3V to +6V
 CU3 to CU2.....-0.3V to +6V
 CU3 to POS.....-0.3V to +18V
 POS to GND.....-0.3V to +18V
 CD1 to MAIN.....+0.3V to -12V
 CD1 to GND.....+0.3V to -6V
 CD2 to CD1.....+0.3V to -6V
 NEG to CD2.....+0.3V to -6V

NEG, CD2 to GND.....+0.3V to -12V
 C1P, C2P to GND.....-0.3V to (V_{IN} + 6V)
 PMP, PMPB to GND.....-0.3V to (V_{MAIN} + 0.3V)
 GND to PGND.....-0.3V to +0.3V
 I_{LX}.....1.0A_{RMS}
 Continuous Power Dissipation (T_A = +70°C)
 24-Pin 4mm x 4mm Thin QFN
 (derate 20.8mW/°C above +70°C).....1667mW
 Short-Circuit Duration (MAIN, POS, NEG).....Continuous
 Operating Temperature Range.....-40°C to +85°C
 Junction Temperature.....+150°C
 Storage Temperature Range.....-65°C to +150°C
 Lead Temperature (soldering, 10s).....+300°C

Stresses beyond those listed under "Absolute Maximum Ratings" may cause permanent damage to the device. These are stress ratings only, and functional operation of the device at these or any other conditions beyond those indicated in the operational sections of the specifications is not implied. Exposure to absolute maximum rating conditions for extended periods may affect device reliability.

ELECTRICAL CHARACTERISTICS

(Circuit of Figure 3, V_{IN} = 3V, CTRL = ONBIAS = IN, T_A = -40°C to +85°C, typical values are at T_A = +25°C, unless otherwise noted. Note 1)

PARAMETER	CONDITIONS	MIN	TYP	MAX	UNITS
IN Operating Supply Range		2.7		5.5	V
IN Undervoltage-Lockout (UVLO) Threshold	Rising edge, 30mV hysteresis	2.1	2.35	2.6	V
IN Quiescent Current	Switching		3	5	mA
IN Shutdown Current	V _{CTRL} = V _{ONBIAS} = 0V	T _A = +25°C	0.4	1	μA
		T _A = +85°C	1		
Thermal Shutdown	Rising temperature, 20°C hysteresis (typ)		+160		°C
MAIN CHARGE PUMP WITH LINEAR REGULATOR					
Main Pump Efficiency	I _{LOAD} = 25mA, V _{IN} = 3.9V		83		%
V _{DD} Charge-Pump Open-Loop Output Impedance	V _{IN} ≥ 3.8V in 1.5x mode		9	20	Ω
	V _{IN} ≥ 3.0V in 2.0x mode		7.5	20	
Operating Frequency		200	250	300	kHz
V _{DD} Output Voltage	Charge-pump pause threshold	5.2	5.5	5.7	V
V _{IN} Falling Switchover to 2.0x Mode		3.75	3.85	3.95	V
V _{IN} Rising Switchover to 1.5x Mode		3.8	3.9	4.0	V
Quiescent Current (Charge Pumps Only)	V _{CTRL} = 0V, ONBIAS = IN		0.87	1.30	mA
V _{MAIN} Regulation Voltage	0.1mA < I _{LOAD} < 25mA	4.9	5.0	5.1	V
Discharge Switch Resistance at V _{MAIN}	V _{ONBIAS} = 0V		1	3	kΩ
POS, NEG CHARGE PUMPS					
Operating Frequency		12.0	15.6	19.5	kHz
Duty Cycle			50		%
POS Pump Efficiency	I _{LOAD} = 100μA		97		%
POS Output Voltage	I _{LOAD} = 0 to 100μA	13.9	14.7	15.3	V
POS Discharge Switch Resistance	V _{ONBIAS} = 0V		3	6	kΩ
NEG Pump Efficiency	I _{LOAD} = -100μA		97		%

Complete Bias and White LED Power Supplies for Small TFT Displays

MAX1578/MAX1579

ELECTRICAL CHARACTERISTICS (continued)

(Circuit of Figure 3, $V_{IN} = 3V$, CTRL = ONBIAS = IN, $T_A = -40^{\circ}C$ to $+85^{\circ}C$, typical values are at $T_A = +25^{\circ}C$, unless otherwise noted. Note 1)

PARAMETER	CONDITIONS		MIN	TYP	MAX	UNITS	
NEG Output Voltage	$I_{LOAD} = 0$ to $-100\mu A$		-10.2	-9.8	-9.3	V	
NEG Discharge Switch Resistance	$V_{ONBIAS} = 0V$			1.5	3	$k\Omega$	
LOGIC INPUT (ONBIAS)							
Logic Input Low Voltage					0.72	V	
Logic Input High Voltage			1.6			V	
Input Current	$T_A = +25^{\circ}C$			0.01	1	μA	
	$T_A = +85^{\circ}C$			1			
LED BACKLIGHTING							
Efficiency	LOAD = 6 LEDs in series at 20mA			84		%	
OUT Voltage Range	(Note 2)		$(V_{IN} - V_{D1})$		32	V	
Overvoltage-Lockout (OVLO) Threshold	V_{OUT} rising, 2V hysteresis		32	34	36	V	
OUT Input Bias Current	$V_{OUT} = 32V$, $V_{CTRL} > 0.24V$		10	20	32	μA	
	$V_{OUT} = V_{IN}$, $V_{CTRL} = 0$	$T_A = +25^{\circ}C$		0.01	1		
		$T_A = +85^{\circ}C$		0.1			
ERROR AMPLIFIER							
CTRL to CS Regulation	$V_{CTRL} = 1.5V$, $V_{IN} = 2.7V$ to $5.5V$	$T_A = +25^{\circ}C$	0.295	0.300	0.305	V	
		$T_A = -40^{\circ}C$ to $+85^{\circ}C$	0.292	0.300	0.308		
CS Input Bias Current	$V_{CS} = V_{CTRL} / 5$	$T_A = +25^{\circ}C$		0.01	1	μA	
		$T_A = +85^{\circ}C$		0.03			
CTRL Input Resistance	$V_{CTRL} < 1.0V$	MAX1578	250	500	780	$k\Omega$	
		MAX1579	$T_A = +25^{\circ}C$	250	500		780
			$T_A = +85^{\circ}C$		185		
CTRL Dual Mode™ Threshold	5mV hysteresis		100	170	240	mV	
CTRL Shutdown Delay	(Note 3)		6.5	8.2	10.5	ms	
CS to COMP Transconductance	$V_{COMP} = 1.0V$		32	60	90	μS	
CS Regulation Derating Function Start Temperature	$V_{CTRL} = 3V$, MAX1579 only			+42		$^{\circ}C$	
CS Regulation Derating Function Slope	$V_{CTRL} = 3V$, $T_A = +65^{\circ}C$, MAX1579 only			-6		$mV/^{\circ}C$	
CS Maximum Brightness Clamp Voltage	MAX1578, $V_{CTRL} = 3V$		310	327	345	mV	
	MAX1579, $V_{CTRL} = 3V$, $T_A = +25^{\circ}C$		322	340	358		
CS Maximum Brightness Voltage at CTRL	MAX1578			1.635		V	
	MAX1579			1.70			
OSCILLATOR							
Operating Frequency	f_{BOOST}		0.8	1.0	1.2	MHz	
Minimum Duty Cycle	PWM mode			12		%	
	Pulse skipping			0			
Maximum Duty Cycle	CTRL = IN, CS = GND		92	95		%	

Dual Mode is a trademark of Maxim Integrated Products, Inc.

Complete Bias and White LED Power Supplies for Small TFT Displays

ELECTRICAL CHARACTERISTICS (continued)

(Circuit of Figure 3, $V_{IN} = 3V$, $CTRL = ONBIAS = IN$, $T_A = -40^{\circ}C$ to $+85^{\circ}C$, typical values are at $T_A = +25^{\circ}C$, unless otherwise noted. Note 1)

PARAMETER	CONDITIONS	MIN	TYP	MAX	UNITS
N-CHANNEL SWITCH					
LX On-Resistance	$I_{LX} = 190mA$		0.82	1.5	Ω
LX Leakage Current	$V_{LX} = 28V$, $CTRL = GND$	$T_A = +25^{\circ}C$	0.01	5	μA
		$T_A = +85^{\circ}C$	1		
LX Current Limit	Duty cycle = 90%	500	700	900	mA

Note 1: All devices are 100% production tested at $T_A = +25^{\circ}C$. Limits over the operating temperature range are guaranteed by design.

Note 2: V_{D1} is the forward-voltage drop of diode D1 in Figure 3.

Note 3: Time from $CTRL$ going below the Dual-Mode threshold to IC shutdown.

Typical Operating Characteristics

(Circuit of Figure 3, $V_{IN} = 3.6V$, $I_{LED} = 20mA$, 4 LEDs, $CTRL = IN$, $T_A = +25^{\circ}C$, unless otherwise noted.)

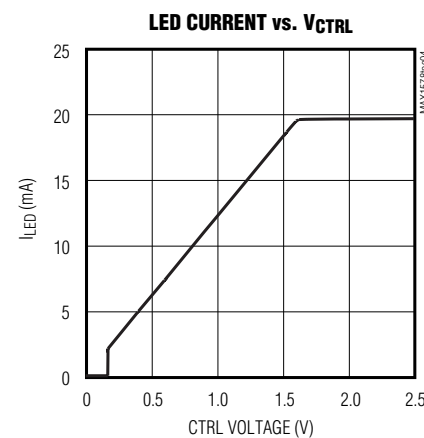
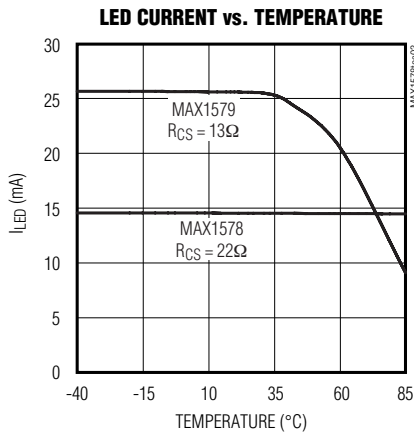
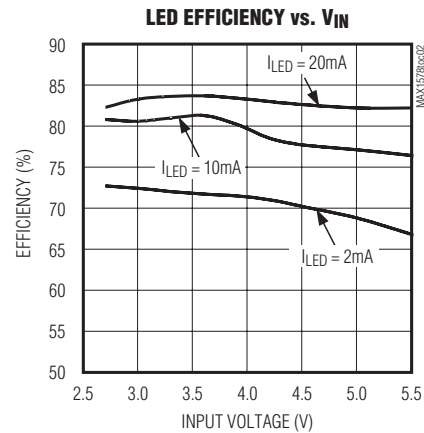
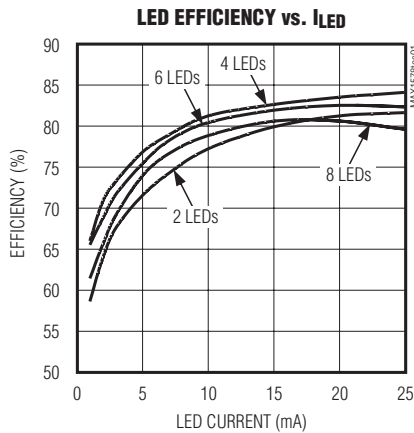

Complete Bias and White LED Power Supplies for Small TFT Displays

MAX1578/MAX1579

Typical Operating Characteristics (continued)

(Circuit of Figure 3, $V_{IN} = 3.6V$, $I_{LED} = 20mA$, 4 LEDs, CTRL = IN, $T_A = +25^\circ C$, unless otherwise noted.)

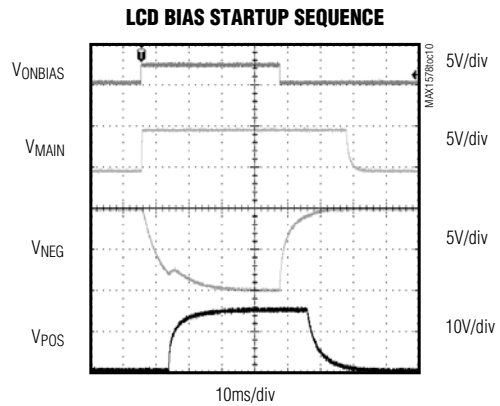
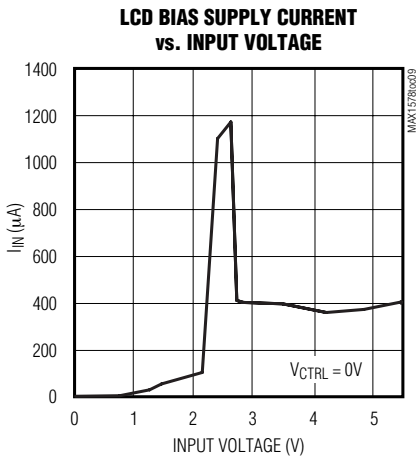
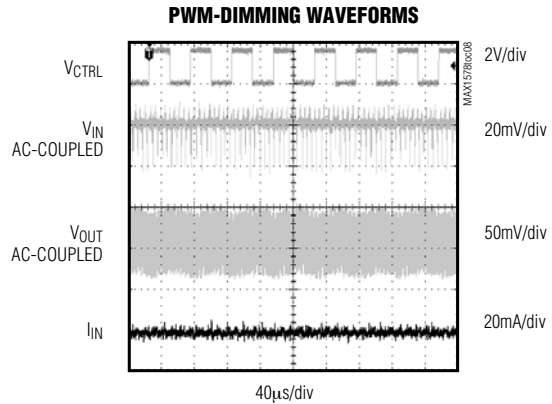
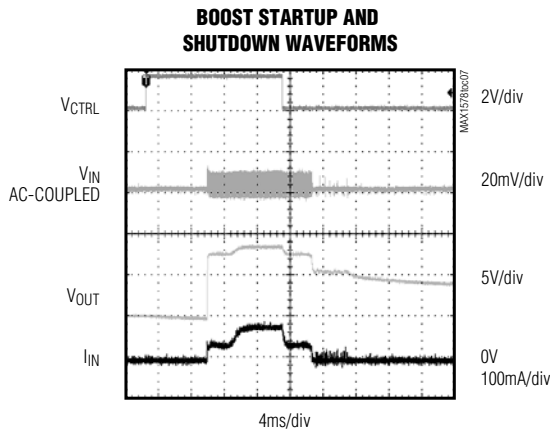
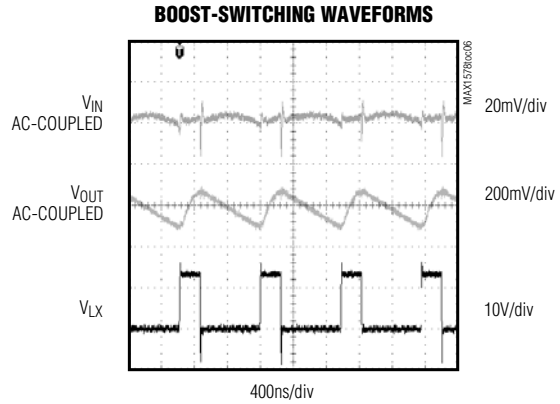
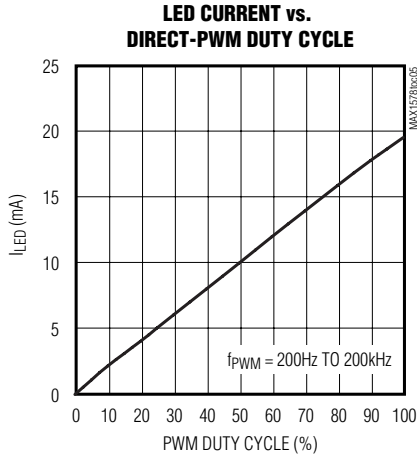

Complete Bias and White LED Power Supplies for Small TFT Displays

Typical Operating Characteristics (continued)

(Circuit of Figure 3, $V_{IN} = 3.6V$, $I_{LED} = 20mA$, 4 LEDs, CTRL = IN, $T_A = +25^\circ C$, unless otherwise noted.)

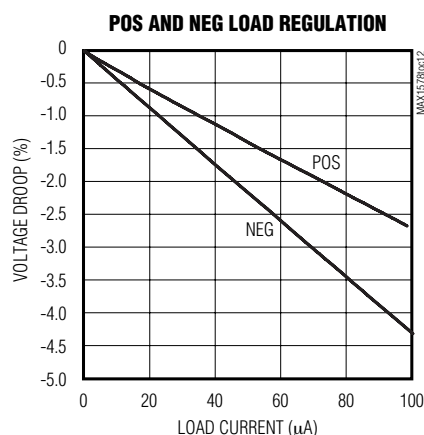
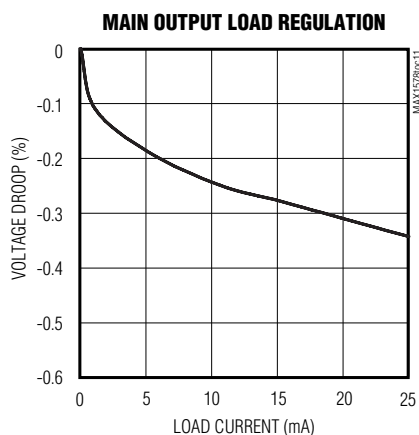

Pin Description

PIN	NAME	FUNCTION
1	MAIN	LDO Output and the POS and NEG Charge-Pump Inputs. V_{MAIN} is regulated to 5V. Bypass to GND with a $1\mu F$ capacitor. Output is internally discharged with a $1k\Omega$ resistor when $V_{ONBIAS} = 0V$.
2	CU1	POS Charge-Pump Capacitor Connection 1. Connect a $1\mu F$ capacitor between CU1 and PMP.
3	CU2	POS Charge-Pump Capacitor Connection 2. Connect a $1\mu F$ capacitor between CU2 and PMPB.
4	CU3	POS Charge-Pump Capacitor Connection 3. Connect a $1\mu F$ capacitor between CU3 and GND.
5	POS	Output of Positive (3x) Charge Pump. Bypass POS to GND with a $1\mu F$ capacitor. POS is internally discharged with a $3k\Omega$ resistor when $V_{ONBIAS} = 0V$.
6	PMP	Charge-Pump Capacitor Connection. Connect a $1\mu F$ capacitor between PMP and CU1 and another $1\mu F$ capacitor between PMP and CD1.
7	PMPB	Charge-Pump Capacitor Connection. Connect a $1\mu F$ capacitor between PMPB and CU2 and another $1\mu F$ capacitor between PMPB and CD2. PMPB is 180° out of phase with PMP.
8	CD1	NEG Charge-Pump Capacitor Connection 1. Connect a $1\mu F$ capacitor and a $200\Omega \pm 5\%$ resistor in series between CD1 and PMP.
9	CD2	NEG Charge-Pump Capacitor Connection 2. Connect a $1\mu F$ capacitor and a $200\Omega \pm 5\%$ resistor in series between CD2 and PMPB.
10	NEG	Output of Inverting (-2x) Charge Pump. Bypass NEG to GND with a $1\mu F$ capacitor. Output is internally discharged with a $1.5k\Omega$ resistor when $V_{ONBIAS} = 0V$.

Complete Bias and White LED Power Supplies for Small TFT Displays

Pin Description (continued)

PIN	NAME	FUNCTION
11	ONBIAS	Logic Input to Enable V_{DD} , MAIN, POS, and NEG Charge Pumps. Drive ONBIAS high to enable all the charge pumps. Connect to GND to disable the charge pumps.
12	GND	Ground. Connect to PGND and the exposed pad directly under the IC.
13	COMP	LED Driver Compensation. Connect a $0.1\mu\text{F}$ from COMP to GND. C_{COMP} stabilizes the driver and sets the soft-start time.
14	CS	Current-Sense Feedback Input. Connect a resistor from CS to GND to set the LED current. For the MAX1578, CS regulates to $V_{CTRL} / 5$ or 0.327V , whichever is lower. For the MAX1579, CS regulates to $V_{CTRL} / 5$ or 0.340V , whichever is lower.
15	CTRL	LED Brightness Control Input. Connect CTRL to a 0.24V to 1.65V input to set the brightness of the external LEDs. Hold CTRL below 100mV for more than 10.5ms , to shut down the LED driver. Drive CTRL with a 200Hz to 200kHz unfiltered PWM dimming signal for DC LED current that is proportional to the signal's duty cycle.
16	OUT	Overvoltage Sense Input. The MAX1578/MAX1579 turn off the n-channel MOSFET when V_{OUT} exceeds 34V . Once V_{OUT} drops below 32V , the IC re-enters soft-start. Bypass OUT to GND with a $0.1\mu\text{F}$ capacitor.
17	LX	Inductor Connection. Connect to the switched side of the external inductor as well as the anode of the external diode. LX is high impedance during shutdown.
18	PGND	Power Ground. Connect to GND and the exposed pad directly under the IC.
19	C1N	Main Charge-Pump Transfer Capacitor Negative Connection 1. Connect a $2.2\mu\text{F}$ capacitor between C1N and C1P.
20	C2N	Main Charge-Pump Transfer Capacitor Negative Connection 2. Connect a $2.2\mu\text{F}$ capacitor between C2N and C2P.
21	IN	Power-Supply Input. Connect to a 2.7V to 5.5V input supply. Bypass IN to GND with a $4.7\mu\text{F}$ capacitor.
22	C2P	Main Charge-Pump Transfer Capacitor Positive Connection 2. Connect a $2.2\mu\text{F}$ capacitor between C2P and C2N.
23	C1P	Main Charge-Pump Transfer Capacitor Positive Connection 1. Connect a $2.2\mu\text{F}$ capacitor between C1P and C1N.
24	V_{DD}	Regulated Main Charge-Pump Output. V_{DD} is regulated to 5.5V . Bypass V_{DD} to GND with a $4.7\mu\text{F}$ capacitor. V_{DD} is connected to IN when ONBIAS is pulled low.
—	EP	Exposed Paddle. Connect directly to a ground plane, GND, and PGND directly under the IC.

MAX1578/MAX1579

Complete Bias and White LED Power Supplies for Small TFT Displays

Block Diagram

MAX1578/MAX1579

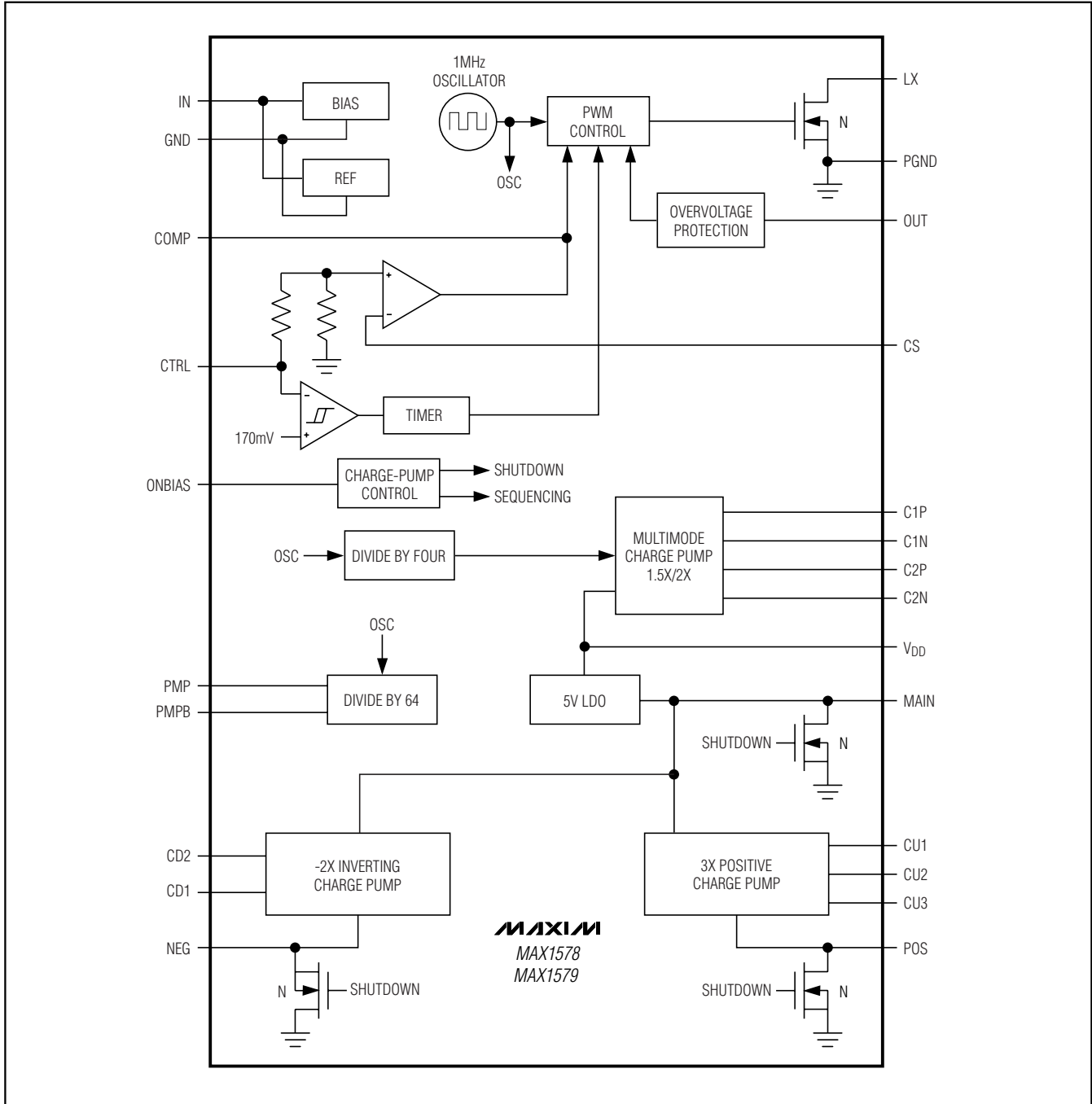

Complete Bias and White LED Power Supplies for Small TFT Displays

Detailed Description

Bias Power and UVLO

The MAX1578/MAX1579 contain an LED driver boost converter and three charge pumps for LCD bias. The undervoltage-lockout (UVLO) feature disables the LED boost converter and the charge pumps when the input voltage is below 2.35V (typ). Once V_{IN} rises above 2.35V, and V_{CTRL} and V_{ONBIAS} are high, the boost converter and charge pumps are enabled, respectively.

Charge-Pump Output Sequencing

The outputs of the MAX1578/MAX1579 charge pumps are sequenced to turn on and off in a predictable fashion. The turn-on sequence is as follows (Figure 1):

- 1) When $ONBIAS$ is high, the MAIN regulator (5V) is enabled.
- 2) When V_{MAIN} exceeds 4.6V, the NEG charge pump (-10V) is enabled.
- 3) When V_{NEG} reaches -8V, the POS charge pump (+15V) is enabled.

The turn-off sequence is as follows (Figure 2):

- 1) When $ONBIAS$ is driven low, the NEG charge pump (-10V) is disabled.
- 2) Once V_{NEG} is discharged to -0.87V, the POS charge pump (+15V) is disabled.
- 3) Once V_{POS} falls to 0.87V, the MAIN regulator (+5V) is disabled and discharged.

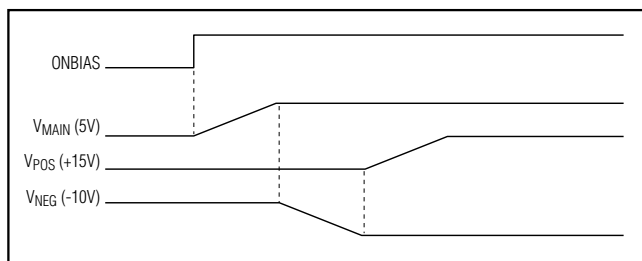

Figure 1. Charge-Pump Turn-On Sequence

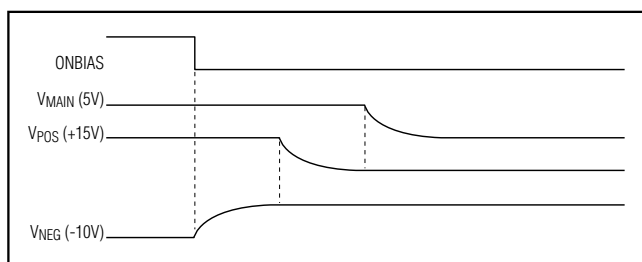

Figure 2. Charge-Pump Turn-Off Sequence

MAIN Charge Pump

The MAX1578/MAX1579 include a charge pump that uses two external capacitors to provide +5.5V output (V_{DD}) that is used to power the regulated LDO +5V output (MAIN). The control logic configures the pump to switch automatically between 1.5x and 2x modes to maximize efficiency. If V_{DD} exceeds 5.5V, the charge pump stops switching. When $ONBIAS$ is driven low, V_{DD} is connected to IN.

A low-dropout linear regulator regulates the output of the main charge pump to +5V at MAIN. The MAIN output is capable of sourcing as much as 25mA to an external load and also supplies the POS and NEG charge pumps. Drive $ONBIAS$ low to disable the MAIN, POS, and NEG outputs. During shutdown, MAIN is discharged to GND with an internal 1k Ω resistor.

POS/NEG Charge Pumps

The MAX1578/MAX1579 include a positive and negative charge pump for LCD bias. The POS and NEG charge pumps are powered from V_{MAIN} . The POS and NEG charge pumps operate at 15.6kHz with a 50% duty cycle.

NEG Charge Pump (-10V Supply)

The NEG charge pump uses capacitors at CD1 and CD2 to generate -10V ($-2 \times V_{MAIN}$). Connect 1 μ F ceramic capacitors and 200 $\Omega \pm 5\%$ resistors in series between CD1 and PMP and between CD2 and PMPB. Drive $ONBIAS$ high to enable MAIN, NEG, and POS. During shutdown, the NEG output is discharged to GND with an internal 1.5k Ω resistor.

POS Charge Pump (+15V Supply)

The POS charge pump uses capacitors at CU1, CU2, and CU3 to generate +15V ($3 \times V_{MAIN}$). Connect 1 μ F ceramic capacitors between CU1 and PMP, between CU2 and PMPB, and between CU3 and GND. Drive $ONBIAS$ high to enable MAIN, NEG, and POS. During shutdown, POS is discharged to GND with an internal 3k Ω resistor.

LED Backlighting Power

LED power is supplied by an internal MOSFET, 1MHz boost converter. The boost converter is capable of driving up to 8 series LEDs at 25mA.

The output of the boost converter is regulated to maintain a constant voltage at CS, and therefore a constant current through the LEDs. Once V_{IN} is increased above the UVLO voltage (2.35V) and V_{CTRL} is above 0.17V, the boost converter enters soft-start and charges the output to its regulation voltage. An overvoltage-protection circuit shuts down the boost converter if V_{OUT} exceeds 34V.

Complete Bias and White LED Power Supplies for Small TFT Displays

Soft-Start

The LED boost converter utilizes a soft-start function to eliminate inrush current during startup. Once the boost converter is enabled, LX begins switching at the minimum duty cycle until C_{COMP} is charged to 1.25V. Once this occurs, the duty cycle increases to further charge the output until V_{CS} reaches 20% of V_{CTRL}. The soft-start time is adjustable using the capacitor from COMP to GND. Calculate the required COMP capacitor as:

$$C_{\text{COMP}} = \frac{12\mu\text{A} \times t_{\text{SS}}}{1.25\text{V}}$$

where t_{SS} is the desired soft-start time in seconds.

Overvoltage Protection

The output of the LED boost converter is protected from overvoltage conditions by internal overvoltage circuitry. If V_{OUT} exceeds 34V, the LX switching terminates. Once V_{OUT} falls below 32V, LX switches normally and soft-start is re-initiated.

Ambient Temperature Derating Function (MAX1579)

The MAX1579 limits the maximum LED current depending on the die temperature. V_{CS} is limited to 340mV up to +42°C. Once the temperature reaches +42°C, the maximum V_{CS} declines by 6mV/°C until the minimum 40mV threshold is reached at +100°C. Due to the package's exposed paddle, the die temperature is always very close to the PC board temperature.

The temperature derating function allows the LED current to be safely set higher at normal operating temperatures, thereby allowing either a brighter display or fewer LEDs to be used for normal display brightness.

Shutdown

The MAX1578/MAX1579 include a low-quiescent-current shutdown mode. To enter shutdown, drive CTRL below 0.1V for longer than 10.5ms and drive ONBIAS low. The quiescent current is reduced to less than 1μA when the boost converter and charge pumps are disabled.

To disable the LED boost converter, drive CTRL below 0.1V for longer than 10.5ms. During shutdown, the internal boost switch from LX to PGND is high impedance; however, a DC path exists from IN to OUT through the external inductor and Schottky diode. Drive CTRL with an analog voltage between 0.24V and 1.65V or a 200Hz to 200kHz digital PWM dimming signal for normal operation. The quiescent current is reduced to 870μA when the boost converter is shut down and the charge pumps are enabled.

Drive ONBIAS low to shut down the internal POS and NEG charge pumps and disable the MAIN LDO output. On-chip pulldown resistors discharge these outputs during shutdown. Drive ONBIAS high for normal operation. V_{DD} is connected to IN when ONBIAS is low. The quiescent current is reduced to 430μA when the charge pumps are shut down and the boost converter is enabled.

Applications Information

Adjusting LED Current

Set the maximum LED current using a resistor from CS to GND. Calculate the resistance as follows:

$$R_{\text{CS}} = \frac{330\text{mV}}{I_{\text{LED}}} \text{ for the MAX1578}$$

$$R_{\text{CS}} = \frac{340\text{mV}}{I_{\text{LED}}} \text{ for the MAX1579}$$

where I_{LED} is the desired maximum current through the LEDs in Amps when V_{CTRL} is 1.65V.

LED Dimming Control Using a DAC

V_{CTRL} controls the LED drive current. The voltage at CS regulates to 20% of V_{CTRL} to control the current through the LEDs and, therefore, the brightness. Drive CTRL using a DAC with an output voltage between 0.24V and 1.65V to control the brightness of the LEDs. Increasing V_{CTRL} beyond 1.65V results in no further brightness increase. Hold CTRL below 100mV for longer than 10.5ms to shut down the boost converter.

LED Dimming Using Direct PWM into CTRL

Another useful technique for LED dimming control is the application of a logic-level PWM signal applied directly to CTRL. LED current may be varied from zero to full scale. The frequency range of the PWM signal is from 200Hz to 200kHz, while 0% duty cycle corresponds to zero current and 100% duty cycle corresponds to full current. The error amplifier and compensation capacitor form a lowpass filter so PWM dimming results in DC current to the LEDs without the need for any additional RC filters. See the *Typical Operating Characteristics*.

Input/Output Ripple

For LED drivers, input and output ripple may be important. Input ripple depends on the source supply's output impedance. Adding a lowpass filter to the input further reduces input ripple. Alternately, increasing C_{IN} to 10μF cuts input ripple in half. Likewise, an output filter or higher output capacitance value reduces output ripple.

Complete Bias and White LED Power Supplies for Small TFT Displays

MAX1578/MAX1579

Component Selection

Use only ceramic capacitors with an X5R, X7R, or better dielectric. See Table 1 for a list of recommended components.

Capacitor Selection

Use low-ESR ceramic capacitors. Recommended values for the capacitors are shown in Table 1. To ensure stability over a wide temperature range, ceramic capacitors with an X5R or X7R dielectric are recommended. Place these capacitors as close to the IC as possible.

Inductor Selection

Recommended inductor values range from 10 μ H to 47 μ H. A 22 μ H inductor optimizes the efficiency for most applications while maintaining low 15mV_{P-P} input ripple. With input voltages near 5V, a larger value of inductance can be more efficient. To prevent core saturation, ensure that the inductor-saturation current rating exceeds the peak inductor current for the application. Calculate the peak inductor current with the following formula:

$$I_{PEAK} = \frac{V_{OUT(MAX)} \times I_{LED(MAX)}}{0.8 \times V_{IN(MIN)}} + \frac{V_{IN(MIN)} \times 0.8\mu s}{2 \times L}$$

Schottky Diode Selection

The MAX1578/MAX1579 require a high-speed rectification diode (D1) for optimum performance. A Schottky diode is recommended due to its fast recovery time and low forward-voltage drop. Ensure that the diode's average and peak current ratings exceed the average output current and the peak inductor current, respectively. In addition, the diode's reverse breakdown voltage must exceed V_{OUT} . The RMS diode current is calculated as:

$$I_{DIODE(RMS)} = \sqrt{I_{OUT} \times I_{PEAK}}$$

PC Board Layout and Routing

Due to fast switching waveforms, careful PC board layout is required. An evaluation kit (MAX1578EVKIT) is available to speed design. When laying out a board, minimize trace lengths between the IC and R1, the

inductor, the diode, the input capacitor, and the output capacitor. Keep traces short, direct, and wide. Keep noisy traces, such as the LX node trace, away from CS. The IN bypass capacitor (C_{IN}) should be placed as close to the IC as possible. The transfer capacitors for the charge pumps should be located as close as possible to the IC. PGND and GND should be connected directly to the exposed paddle underneath the IC. The ground connections of C_{IN} and C_{OUT} should be as close together as possible. The traces from IN to the inductor and from the Schottky diode to the LEDs may be longer. The MAX1579 evaluation kit contains a sample layout to speed designs.

Chip Information

TRANSISTOR COUNT: 3801

PROCESS: BiCMOS

Complete Bias and White LED Power Supplies for Small TFT Displays

Table 1. Recommended Components for the Typical Application Circuit

DESIGNATION	DESCRIPTION
C1, C8	4.7µF, 6.3V X5R ceramic capacitors (0603) Murata GRM188R60J475KE19
C2	0.1µF, 6.3V X5R ceramic capacitor (0402) TDK C1005X5R1A104K
C3	0.1µF, 50V X7R ceramic capacitor (0603) TDK C1608X7R1H104K
C4, C5, C12	1µF, 16V X7R ceramic capacitors (0805) TDK C2012X7R1C105K
C6, C7	2.2µF, 6.3V X5R ceramic capacitors (0603) Taiyo Yuden JMK107BJ225KA
C9, C10, C11, C13, C14	1µF, 6.3V X5R ceramic capacitors (0402) Murata GRM155R60J105KE19
D1	40V, 0.5A Schottky diode International Rectifier MBRX0540
D2-D7	White LEDs Nichia NSCW215T
L1	22µH, 250mA inductor (1210) Murata LQH32CN220K53
R1	22.1Ω ±1% resistor (0402)
R2, R3	200Ω ±5% resistors (0402)

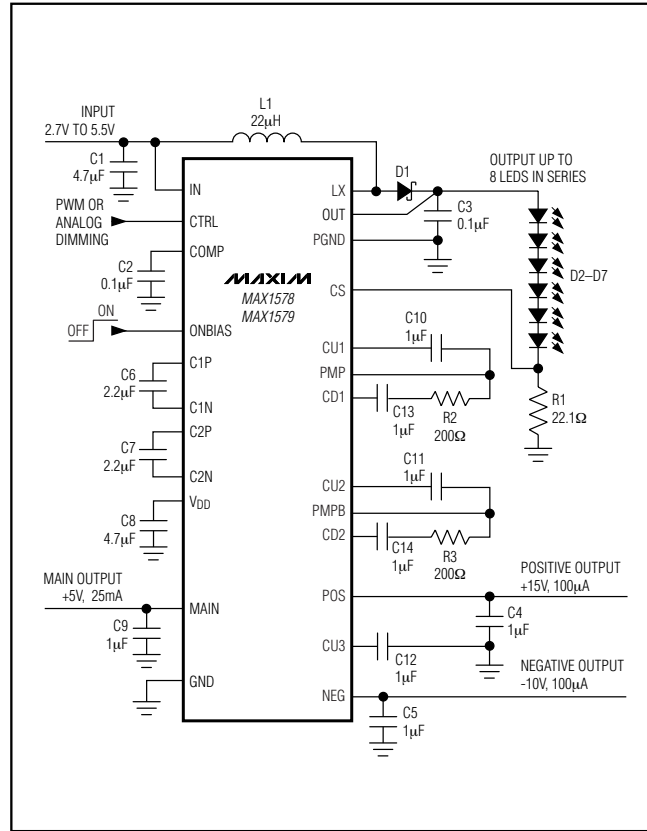

Figure 3. Typical Application Circuit

Ordering Information (continued)

PART	TEMP RANGE	PIN-PACKAGE
MAX1579ETG	-40°C to +85°C	24 Thin QFN 4mm x 4mm (T2444-4)
MAX1579ETG+	-40°C to +85°C	24 Thin QFN 4mm x 4mm (T2444-4)

+ Denotes lead-free package.

Complete Bias and White LED Power Supplies for Small TFT Displays

Package Information

(The package drawing(s) in this data sheet may not reflect the most current specifications. For the latest package outline information, go to www.maxim-ic.com/packages.)

MAX1578/MAX1579

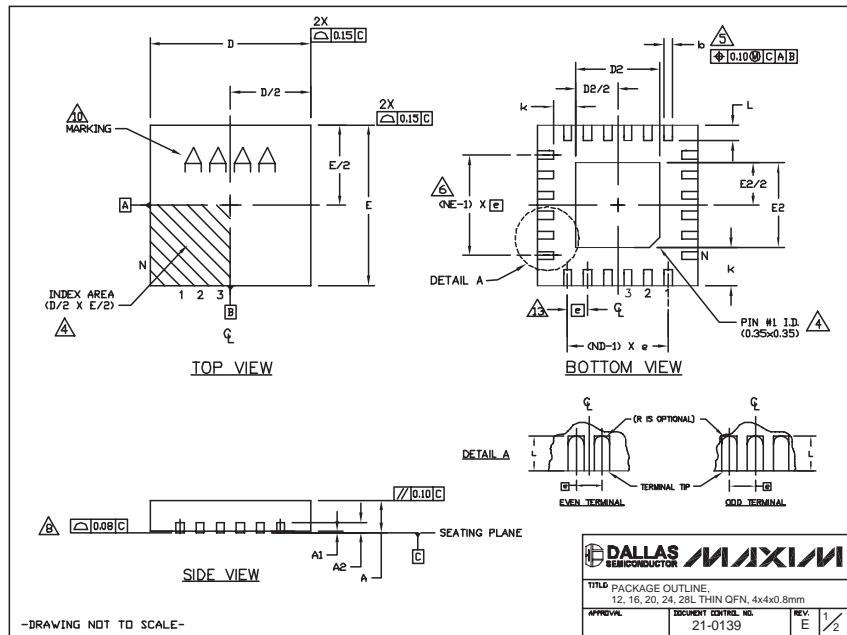

COMMON DIMENSIONS															
PKG REF.	12L 4x4			16L 4x4			20L 4x4			24L 4x4			28L 4x4		
	MIN.	NDM.	MAX.	MIN.	NDM.	MAX.	MIN.	NDM.	MAX.	MIN.	NDM.	MAX.	MIN.	NDM.	MAX.
A	0.70	0.75	0.80	0.70	0.75	0.80	0.70	0.75	0.80	0.70	0.75	0.80	0.70	0.75	0.80
A1	0.0	0.02	0.05	0.0	0.02	0.05	0.0	0.02	0.05	0.0	0.02	0.05	0.0	0.02	0.05
AE	0.20 REF.			0.20 REF.			0.20 REF.			0.20 REF.			0.20 REF.		
b	0.25	0.30	0.35	0.25	0.30	0.35	0.20	0.25	0.30	0.10	0.23	0.30	0.15	0.20	0.25
D	3.90	4.00	4.10	3.90	4.00	4.10	3.90	4.00	4.10	3.90	4.00	4.10	3.90	4.00	4.10
E	3.90	4.00	4.10	3.90	4.00	4.10	3.90	4.00	4.10	3.90	4.00	4.10	3.90	4.00	4.10
e	0.20 BSC.			0.25 BSC.			0.30 BSC.			0.30 BSC.			0.40 BSC.		
k	0.25	-	0.25	-	0.25	-	0.25	-	0.25	-	0.25	-	0.25	-	0.25
L	0.45	0.55	0.65	0.45	0.55	0.65	0.45	0.55	0.65	0.30	0.40	0.50	0.30	0.40	0.50
N	12	16	20	16	20	24	20	24	28	24	28	32	28	32	36
ND	3	4	5	4	5	6	5	6	7	6	7	8	7	8	9
NE	3	4	5	4	5	6	5	6	7	6	7	8	7	8	9
WGGC	VGG3			VGGC			VGGD-1			VGGD-2			VGGE		

EXPOSED PAD VARIATIONS												
PKG CODES	D2			E2			BOND BOUNDS ALLOWED					
	MIN.	NDM.	MAX.	MIN.	NDM.	MAX.						
T1844-2	1.95	2.10	2.25	1.95	2.10	2.25	YES					
T1244-4	1.95	2.10	2.25	1.95	2.10	2.25	NO					
T1644-3	1.95	2.10	2.25	1.95	2.10	2.25	YES					
T1644-4	1.95	2.10	2.25	1.95	2.10	2.25	NO					
T2044-2	1.95	2.10	2.25	1.95	2.10	2.25	YES					
T2044-3	1.95	2.10	2.25	1.95	2.10	2.25	NO					
T2444-2	1.95	2.10	2.25	1.95	2.10	2.25	YES					
T2444-3	2.45	2.60	2.63	2.45	2.60	2.63	YES					
T2444-4	2.45	2.60	2.63	2.45	2.60	2.63	NO					
T2844-1	2.50	2.60	2.70	2.50	2.60	2.70	NO					

NOTES:

- DIMENSIONING & TOLERANCING CONFORM TO ASME Y14.5M-1994.
- ALL DIMENSIONS ARE IN MILLIMETERS. ANGLES ARE IN DEGREES.
- N IS THE TOTAL NUMBER OF TERMINALS.
- THE TERMINAL #1 IDENTIFIER AND TERMINAL NUMBERING CONVENTION SHALL CONFORM TO JEDEC 95-1 SFP-012. DETAILS OF TERMINAL #1 IDENTIFIER ARE OPTIONAL, BUT MUST BE LOCATED WITHIN THE ZONE INDICATED. THE TERMINAL #1 IDENTIFIER MAY BE EITHER A MOLD OR MARKED FEATURE.
- DIMENSION b APPLIES TO METALLIZED TERMINAL AND IS MEASURED BETWEEN 0.25 mm AND 0.30 mm FROM TERMINAL TIP.
- ND AND NE REFER TO THE NUMBER OF TERMINALS ON EACH D AND E SIDE RESPECTIVELY.
- DEPOPULATION IS POSSIBLE IN A SYMMETRICAL FASHION.
- COPLANARITY APPLIES TO THE EXPOSED HEAT SINK SLUG AS WELL AS THE TERMINALS.
- DRAWING CONFORMS TO JEDEC MO220, EXCEPT FOR T2444-3, T2444-4 AND T2844-1.
- MARKING IS FOR PACKAGE ORIENTATION REFERENCE ONLY.
- COPLANARITY SHALL NOT EXCEED 0.08mm
- WARPAGE SHALL NOT EXCEED 0.10mm
- LEAD CENTERLINES TO BE AT TRUE POSITION AS DEFINED BY BASIC DIMENSION "e", ±0.05.
- NUMBER OF LEADS SHOWN ARE FOR REFERENCE ONLY

APPROVAL

MAXIM

TITLE PACKAGE OUTLINE
12, 16, 20, 24, 28L THIN QFN, 4x4x0.8mm

21-0139

Maxim cannot assume responsibility for use of any circuitry other than circuitry entirely embodied in a Maxim product. No circuit patent licenses are implied. Maxim reserves the right to change the circuitry and specifications without notice at any time.

Maxim Integrated Products, 120 San Gabriel Drive, Sunnyvale, CA 94086 408-737-7600 13

Mouser Electronics

Authorized Distributor

Click to View Pricing, Inventory, Delivery & Lifecycle Information:

[Maxim Integrated:](#)

[MAX1578ETG](#) [MAX1578ETG-T](#)