

MAXIM

CMOS Analog Switches

DG304(A)/DG305(A)/DG306(A)/DG307(A)

General Description

Maxim's DG304-DG307 and DG304A-DG307A CMOS dual and quad analog switches combine low power operation with fast switching times and superior DC and AC switch characteristics. On resistance is less than 50Ω and is essentially constant over the analog signal range. Device specifications are ideal for battery powered circuitry.

These switches are available in a variety of formats as outlined below in the Pin Configurations section. The switch control logic inputs are compatible with CMOS logic. Also featured are "break-before-make" switching and low charge injection.

Maxim's DG304-DG307 and DG304A-DG307A families are electrically compatible and pin compatible with the original manufacturer's devices. All devices will operate with power supplies ranging from ±5V to ±18V. Single supply operation is implemented by connecting V⁻ to GND.

Applications

- Portable Instruments
- Low Power Sample/Holds
- Power Supply Switching
- Programmable Gain Amplifiers
- SPDT and DPDT Functions
- Process Control and Telemetry

Features

- ◆ Monolithic Low Power CMOS
- ◆ Latch-Up Proof Construction
- ◆ Fully Compatible 2nd Source
- ◆ Low On Resistance, <50Ω
- ◆ Fast Switching Time
- ◆ V⁺ to V⁻ Analog Signal Range
- ◆ Single Supply Capability

Ordering Information

PART	TEMP RANGE	PACKAGE
DG304C/D	0°C to +70°C	Dice
DG304CJ	0°C to +70°C	14 Lead Plastic DIP
DG304CWE	0°C to +70°C	16 Lead Wide SO
DG304CK	0°C to +70°C	14 Lead CERDIP
DG304BWE	-25°C to +85°C	16 Lead Wide SO
DG304BK	-25°C to +85°C	14 Lead CERDIP
DG304BA	-25°C to +85°C	10 Lead Metal Can
DG304AK	-55°C to +125°C	14 Lead CERDIP
DG304AA	-55°C to +125°C	10 Lead Metal Can

Ordering Information continued at end of data sheet.

Pin Configurations

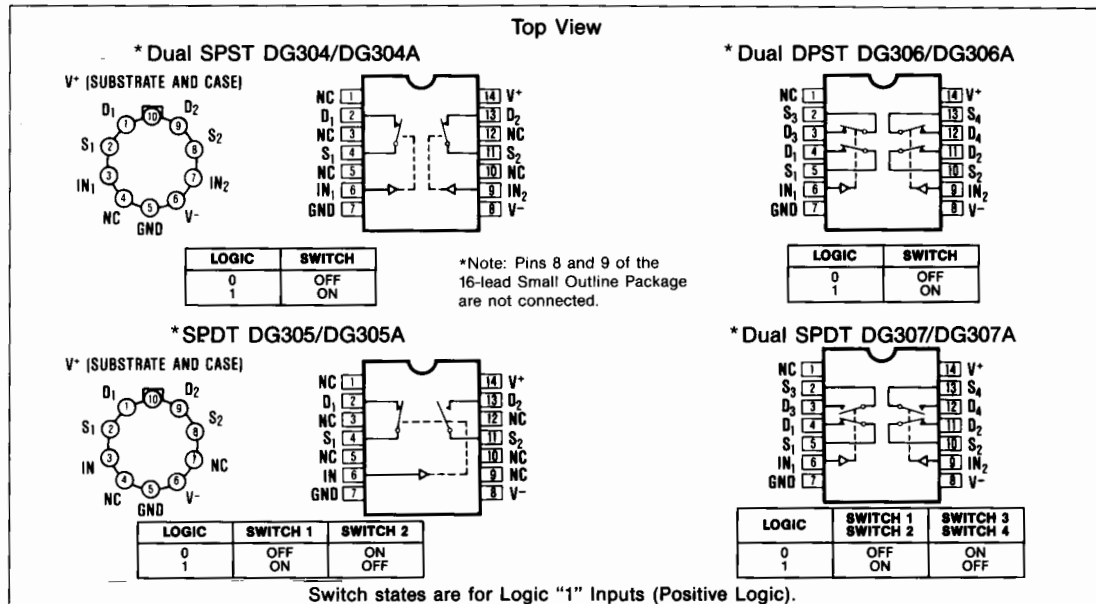

CMOS Analog Switches

ABSOLUTE MAXIMUM RATINGS

Voltages Referenced to V ⁻	
V ⁺ (DG304-DG307)	36V
V ⁺ (DG304A-DG307A)	44V
GND	25V
Digital Inputs, V _S , V _D (Note 1)	-4V to (V ⁺ + 4V) or 30mA, whichever occurs first.
Current, Any Terminal Except S or D	30mA
Continuous Current, S or D	30mA
(Pulsed at 1msec, 10% duty cycle max)	100mA
Storage Temperature (A & B Suffix)	-65°C to 150°C
(C Suffix)	-65°C to 125°C

Operating Temperature (A Suffix)	-55°C to 125°C
(B Suffix)	-25°C to 85°C
(C Suffix)	0°C to 70°C
Lead Temperature (Soldering 10 sec.)	+300°C
Power Dissipation*	
Cerdip (K) (Derate 11mW/°C above 75°C)	825mW
Plastic DIP (J) (Derate 6.5mW/°C above 25°C)	470mW
Metal Can (A) (Derate 6mW/°C above 75°C)	450mW

* Device mounted with all leads soldered or welded to PC board.

Stresses listed under "Absolute Maximum Ratings" may be applied (one at a time) to devices without resulting in permanent damage. These are stress ratings only, and functional operation of the device at these or any other conditions above those indicated in the operational sections of the specifications is not implied. Exposure to absolute maximum ratings conditions for extended periods may affect device reliability.

ELECTRICAL CHARACTERISTICS (V⁺ = +15V, V⁻ = -15V, GND = 0V, T_A = 25°C, unless otherwise indicated)

	PARAMETER	SYMBOL	TEST CONDITIONS	DG304-DG307A DG304A-DG307AA		DG304-DG307B/C DG304A-DG307AB/C		UNITS		
				MIN	TYP (Note 2)	MAX (Note 3)	MIN		TYP (Note 2)	MAX (Note 3)
SWITCH	Analog Signal Range	V _{ANALOG}	I _S = 10mA, V _{in} = 3.5V or 11.0V	-15		15	-15	15	V	
	Drain-Source ON Resistance	r _{DS(on)}	I _S = -10mA, V _D = 10V I _S = 10mA, V _D = -10V	30	50	30	50	50	Ω	
				30	50	30	50			
	Source OFF Leakage Current	I _{S(off)}	V _{in} = 3.5V or V _{in} = 11.0V	V _S = 14V, V _D = -14V	0.1	1	0.1	5	nA	
				V _S = -14V, V _D = 14V	-1	-0.1	-5	-0.1		
	Drain OFF Leakage Current	I _{D(off)}	V _S = -14V, V _D = 14V	0.1	1	0.1	5			
V _S = 14V, V _D = -14V			-1	-0.1	-5	-0.1				
Drain ON Leakage Current	I _{D(on)}	V _D = V _S = 14V V _D = V _S = -14V	0.1	1	0.1	5	-2	-0.1	-5	-0.1
INPUT	Input Current/ Voltage High	I _{INH}	V _{in} = 5.0V	-1	-0.001	-1	-0.001	μA		
			V _{in} = 15V	0.001	1	0.001	1			
	Input Current/ Voltage Low	I _{INL}	V _{in} = 0V	-1	-0.001	-1	-0.001			
DYNAMIC	Turn-ON Time	t _{on}	See Switching Time Test Circuit	110	250	110	250	ns		
	Turn-OFF Time	t _{off}		70	150	70	150			
	Break-Before-Make Interval	t _{on} -t _{off}	See Break-Before-Make Time Test Circuit DG305(A)/DG307(A) Only	50		50				
	Charge Injection	Q	C _L = 10nF, R _{gen} = 0Ω, V _{gen} = 0V	12		12		pC		
	Source OFF Capacitance	C _{S(off)}	f = 1MHz, V _{in} = 3.5V or V _{in} = 11.0V	V _S = 0V	14		14	pF		
	Drain OFF Capacitance	C _{D(off)}		V _D = 0V	14		14			
	Channel-ON Capacitance	C _{D(on)} + C _{S(on)}		V _S = V _D = 0V	40		40			
Input Capacitance	C _{in}	f = 1MHz	V _{in} = 0V	6		6				
			V _{in} = 15V	7		7				
Off Isolation (Note 4)				62		62				
Crosstalk (Channel to Channel)		V _{in} = 0V, R _L = 1kΩ V _S = 1 V _{RMS} , f = 500kHz		74		74	dB			

(See Notes next page).

CMOS Analog Switches

DG304(A)/DG305(A)/DG306(A)/DG307(A)

ELECTRICAL CHARACTERISTICS (Continued)

(V⁺ = +15V, V⁻ = -15V, GND = 0V, T_A = 25°C, unless otherwise indicated)

	PARAMETER	SYMBOL	TEST CONDITIONS	DG304-DG307A DG304A-DG307AA			DG304-DG307B/C DG304A-DG307AB/C			UNITS
				MIN (Note 2)	TYP (Note 3)	MAX	MIN (Note 2)	TYP (Note 3)	MAX	
SUPPLY	Positive Supply Current	I ⁺	V _{in} = 15.0V (All Inputs)	0.001		10	0.001		10	μA
	Negative Supply Current	I ⁻		-10		-0.001	-10		-0.001	
	Positive Supply Current	I ⁺	V _{in} = 0V (All Inputs)	0.001		10	0.001		10	
	Negative Supply Current	I ⁻		-10		-0.001	-10		-0.001	

ELECTRICAL CHARACTERISTICS (Over Temperature)

(V⁺ = +15V, GND = 0V, T_A = Over Temperature Range, unless otherwise noted)

	PARAMETER	SYMBOL	TEST CONDITIONS	DG304-DG307A DG304A-DG307AA			DG304-DG307B/C DG304A-DG307AB/C			UNITS	
				MIN (Note 2)	TYP (Note 3)	MAX	MIN (Note 2)	TYP (Note 3)	MAX		
SWITCH	Analog Signal Range	V _{ANALOG}	I _S = 10mA, V _{in} = 3.5V or 11.0V	-15		15	-15		15	V	
	Drain-Source ON Resistance	r _{DS(on)}	V _{in} = 3.5V or 11.0V	I _S = -10mA, V _D = 10V		75			75	Ω	
				I _S = 10mA, V _D = -10V		75			75		
	Source OFF Leakage Current	I _{S(off)}	V _{in} = 3.5V or 11.0V	V _S = 14V, V _D = -14V			100			100	nA
				V _S = -14V, V _D = 14V	-100			-100			
	Drain OFF Leakage Current	I _{D(off)}	V _{in} = 3.5V or 11.0V	V _S = -14V, V _D = 14V			100			100	
				V _S = 14V, V _D = -14V	-100			-100			
Drain ON Leakage Current	I _{D(on)}	V _{in} = 3.5V or 11.0V	V _D = V _S = 14V			100			100		
			V _D = V _S = -14V	-200			-200				
INPUT	Input Current/Voltage High	I _{INH}	V _{in} = 5.0V	-1			-10			μA	
			V _{in} = 15V			1			10		
	Input Current/Voltage Low	I _{INL}	V _{in} = 0V	-1			-10				
SUPPLY	Positive Supply Current	I ⁺	V _{in} = 15.0V (All Inputs)			100			200	μA	
	Negative Supply Current	I ⁻		-100			-200				
	Positive Supply Current	I ⁺	V _{in} = 0V (All Inputs)			100			200		
	Negative Supply Current	I ⁻		-100			-200				

Note 1: Signals on S_x, D_x, or IN_x exceeding V⁺ or V⁻ will be clamped by internal diodes. Limit diode forward current to maximum current ratings.

Note 2: The algebraic convention whereby the most negative value is a minimum, and the most positive value is a maximum is used in this data sheet.

Note 3: Typical values are for DESIGN AID ONLY, not guaranteed nor subject to production testing.

Note 4: OFF isolation = 20 log $\frac{V_S}{V_D}$, V_S = input to OFF switch, V_D = Output.

CMOS Analog Switches

Typical Operating Characteristics

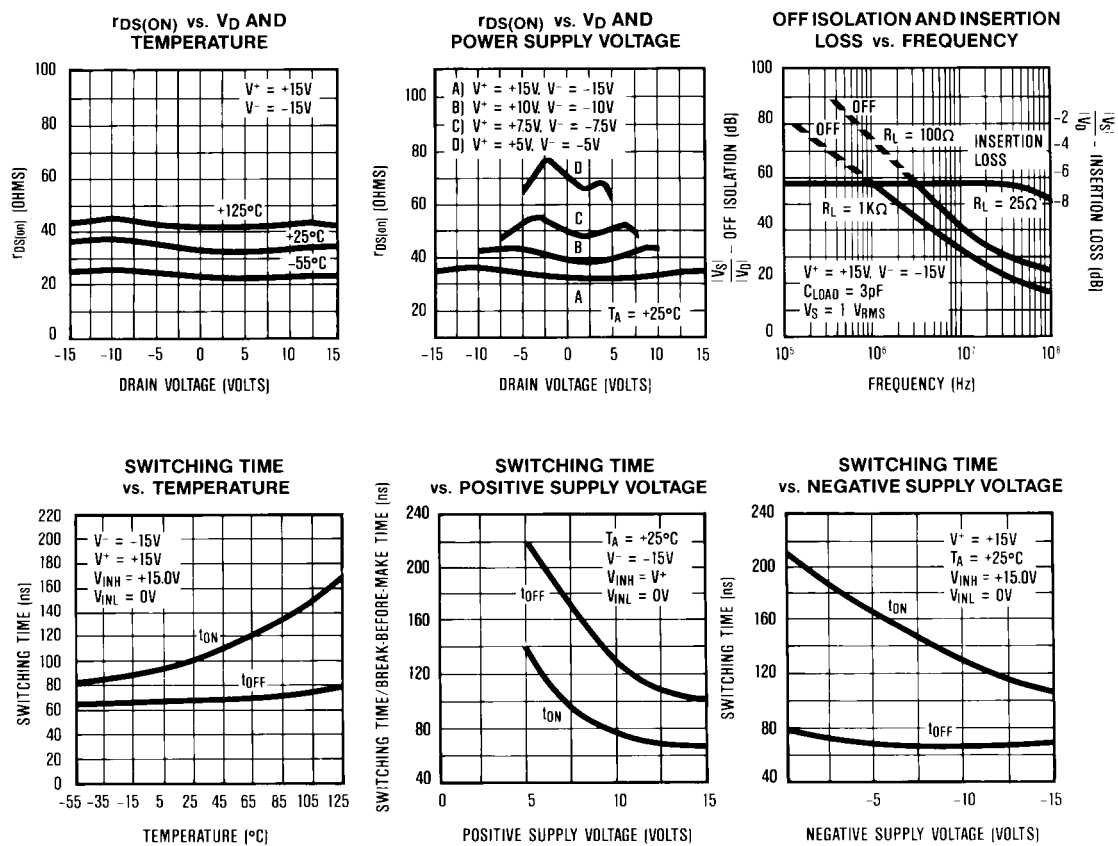

Test Circuits

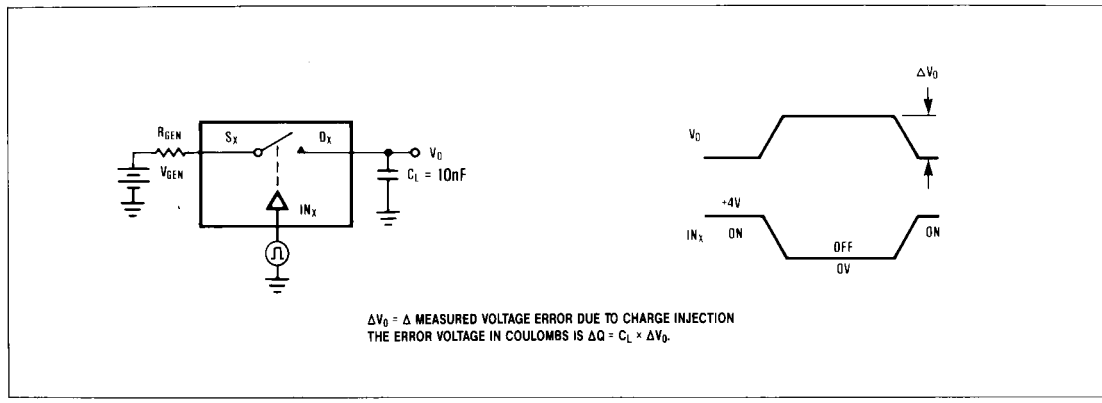

Figure 1. Charge Injection Test Circuit.

CMOS Analog Switches

Test Circuits (Continued)

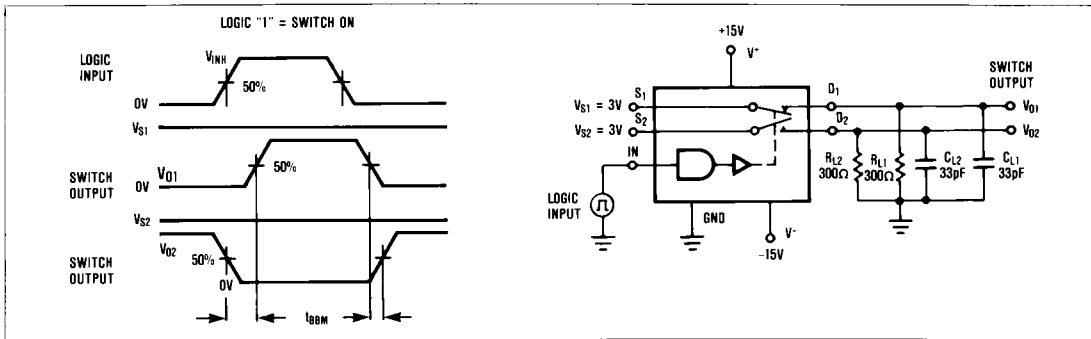

Figure 2. Break-Before-Make Time Test Circuit SPDT DG305(A), DG307(A).

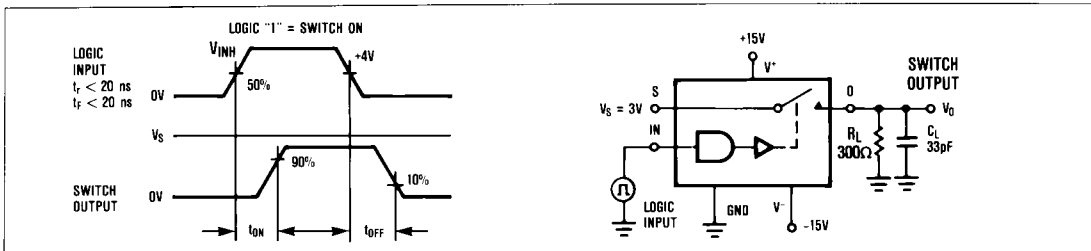

Figure 3. Switching Time Test Circuit.

Application Information

All DG304 family switches will operate with ± 15 V power supplies. They can also be used with single ended power supplies ranging from +10V to +30V where the V^- terminal is connected to ground. In either case analog signals ranging from V^+ to V^- can be switched.

The on resistance variation with analog signal and supply voltage is shown in the Typical Operating Characteristics graphs. The temperature coefficient of R_{ON} is typically 0.5%/°C. Typical on resistance matching from channel to channel is 10%. In addition, Table 1 outlines some typical parameters for single supply operation.

Table 1. Typical Single Supply Parameters

	V^+ SUPPLY VOLTAGE ($V^- = 0V$)			
	+10V	+15V	+20V	+30V
Switching Time ($R_L = 1k\Omega$)				
t_{ON}	220ns	180ns	165ns	110ns
t_{OFF}	60ns	40ns	30ns	20ns
On Resistance				
$V_{SIGNAL} = +1V$	71 Ω	51 Ω	42 Ω	31 Ω
$V_{SIGNAL} = V^+/2$	77 Ω	54 Ω	43 Ω	30 Ω
$V_{SIGNAL} = V^+$	84 Ω	63 Ω	54 Ω	43 Ω
Input Logic Levels	3.5V, 11.0V	3.5V, 11.0V	3.5V, 12.5V	3.5V, 22.0V

The charge injection test circuit is shown in Figure 1. Table 2 lists the typical injected charge for DG304 series switches with various input voltages.

Table 2. Charge Injection ($\pm 15V$ Supplies)

ANALOG INPUT	INJECTED Q
+10V	4pC
+5V	8pC
0V	12pC
-5V	8pC
-10V	5pC

CMOS Analog Switches

Ordering Information (continued)

DG304(A)/DG305(A)/DG306(A)/DG307(A)

PART	TEMP. RANGE	PACKAGE
DG304AC/D	0°C to +70°C	Dice
DG304ACJ	0°C to +70°C	14 Lead Plastic DIP
DG304ACWE	0°C to +70°C	16 Lead Wide SO
DG304ACK	0°C to +70°C	14 Lead CERDIP
DG304ABWE	-25°C to +85°C	16 Lead Wide SO
DG304ABK	-25°C to +85°C	14 Lead CERDIP
DG304ABA	-25°C to +85°C	10 Lead Metal Can
DG305C/D	0°C to +70°C	Dice
DG305CJ	0°C to +70°C	14 Lead Plastic DIP
DG305CWE	0°C to +70°C	16 Lead Wide SO
DG305CK	0°C to +70°C	14 Lead CERDIP
DG305BWE	-25°C to +85°C	16 Lead Wide SO
DG305BK	-25°C to +85°C	14 Lead CERDIP
DG305BA	-25°C to +85°C	10 Lead Metal Can
DG305AK	-55°C to +125°C	14 Lead CERDIP
DG305AA	-55°C to +125°C	10 Lead Metal Can
DG305AC/D	0°C to +70°C	Dice
DG305ACJ	0°C to +70°C	14 Lead Plastic DIP
DG305ACWE	0°C to +70°C	16 Lead Wide SO
DG305ACK	0°C to +70°C	14 Lead CERDIP
DG305ABWE	-25°C to +85°C	16 Lead Wide SO
DG305ABK	-25°C to +85°C	14 Lead CERDIP
DG305ABA	-25°C to +85°C	10 Lead Metal Can

PART	TEMP. RANGE	PACKAGE
DG306C/D	0°C to +70°C	Dice
DG306CJ	0°C to +70°C	14 Lead Plastic DIP
DG306CWE	0°C to +70°C	16 Lead Wide SO
DG306CK	0°C to +70°C	14 Lead CERDIP
DG306BWE	-25°C to +85°C	16 Lead Wide SO
DG306BK	-25°C to +85°C	14 Lead CERDIP
DG306AK	-55°C to +125°C	14 Lead CERDIP
DG306AC/D	0°C to +70°C	Dice
DG306ACJ	0°C to +70°C	14 Lead Plastic DIP
DG306ACWE	0°C to +70°C	16 Lead Wide SO
DG306ACK	0°C to +70°C	14 Lead CERDIP
DG306ABWE	-25°C to +85°C	16 Lead Wide SO
DG306ABK	-25°C to +85°C	14 Lead CERDIP
DG307C/D	0°C to +70°C	Dice
DG307CJ	0°C to +70°C	14 Lead Plastic DIP
DG307CWE	0°C to +70°C	16 Lead Wide SO
DG307CK	0°C to +70°C	14 Lead CERDIP
DG307BWE	-25°C to +85°C	16 Lead Wide SO
DG307BK	-25°C to +85°C	14 Lead CERDIP
DG307AK	-55°C to +125°C	14 Lead CERDIP
DG307AC/D	0°C to +70°C	Dice
DG307ACJ	0°C to +70°C	14 Lead Plastic DIP
DG307ACWE	0°C to +70°C	16 Lead Wide SO
DG307ACK	0°C to +70°C	14 Lead CERDIP
DG307ABWE	-25°C to +85°C	16 Lead Wide SO
DG307ABK	-25°C to +85°C	14 Lead CERDIP

CMOS Analog Switches

Package Information

(The package drawing(s) in this data sheet may not reflect the most current specifications. For the latest package outline information go to www.maxim-ic.com/packages.)

MAX304(A)/DG305(A)/DG306(A)/DG307(A)

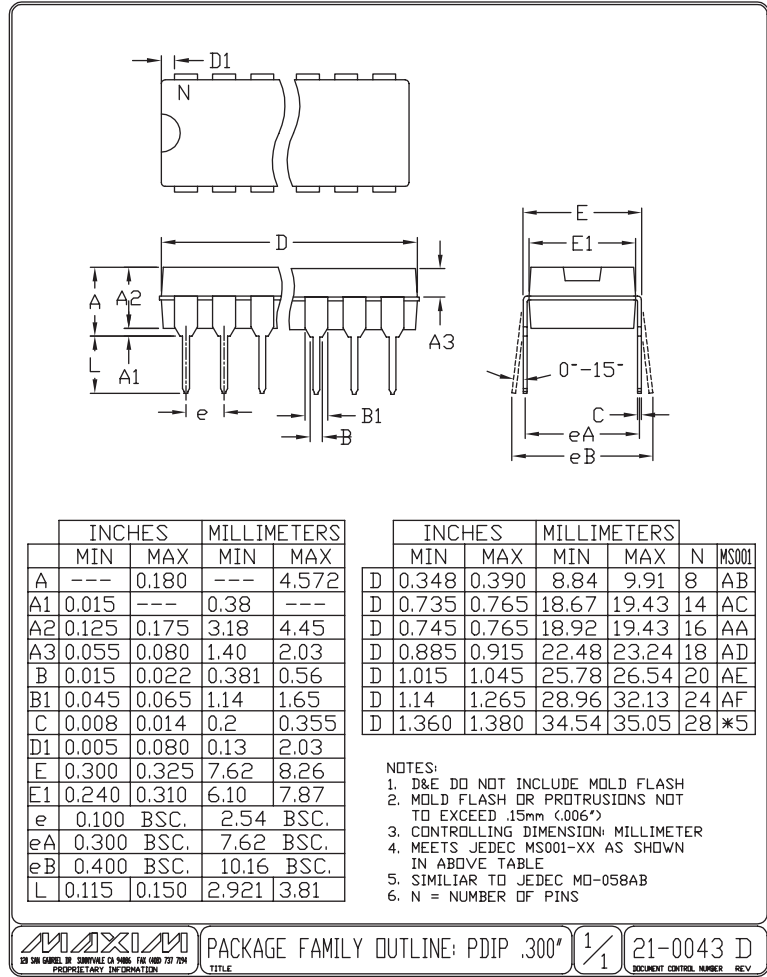

CMOS Analog Switches

Package Information (continued)

(The package drawing(s) in this data sheet may not reflect the most current specifications. For the latest package outline information go to www.maxim-ic.com/packages.)

DG304(A)/DG305(A)/DG306(A)/DG307(A)

TOP VIEW

FRONT VIEW

SIDE VIEW

DIM	INCHES		MILLIMETERS	
	MIN	MAX	MIN	MAX
A	0.093	0.104	2.35	2.65
A1	0.004	0.012	0.10	0.30
B	0.014	0.019	0.35	0.49
C	0.009	0.013	0.23	0.32
e	0.050		1.27	
E	0.291	0.299	7.40	7.60
H	0.394	0.419	10.00	10.65
L	0.016	0.050	0.40	1.27

VARIATIONS:

DIM	INCHES		MILLIMETERS		N	MS013
	MIN	MAX	MIN	MAX		
D	0.398	0.413	10.10	10.50	16	AA
D	0.447	0.463	11.35	11.75	18	AB
D	0.496	0.512	12.60	13.00	20	AC
D	0.598	0.614	15.20	15.60	24	AD
D	0.697	0.713	17.70	18.10	28	AE

NOTES:

- D&E DO NOT INCLUDE MOLD FLASH.
- MOLD FLASH OR PROTRUSIONS NOT TO EXCEED 0.15mm (.006").
- LEADS TO BE COPLANAR WITHIN 0.10mm (.004").
- CONTROLLING DIMENSION: MILLIMETERS.
- MEETS JEDEC MS013.
- N = NUMBER OF PINS.

PROPRIETARY INFORMATION
 TITLE: PACKAGE OUTLINE, .300" SOIC
 APPROVAL: _____ DOCUMENT CONTROL NO: 21-0042 REV: B 1/1

CMOS Analog Switches

Package Information (continued)

(The package drawing(s) in this data sheet may not reflect the most current specifications. For the latest package outline information go to www.maxim-ic.com/packages.)

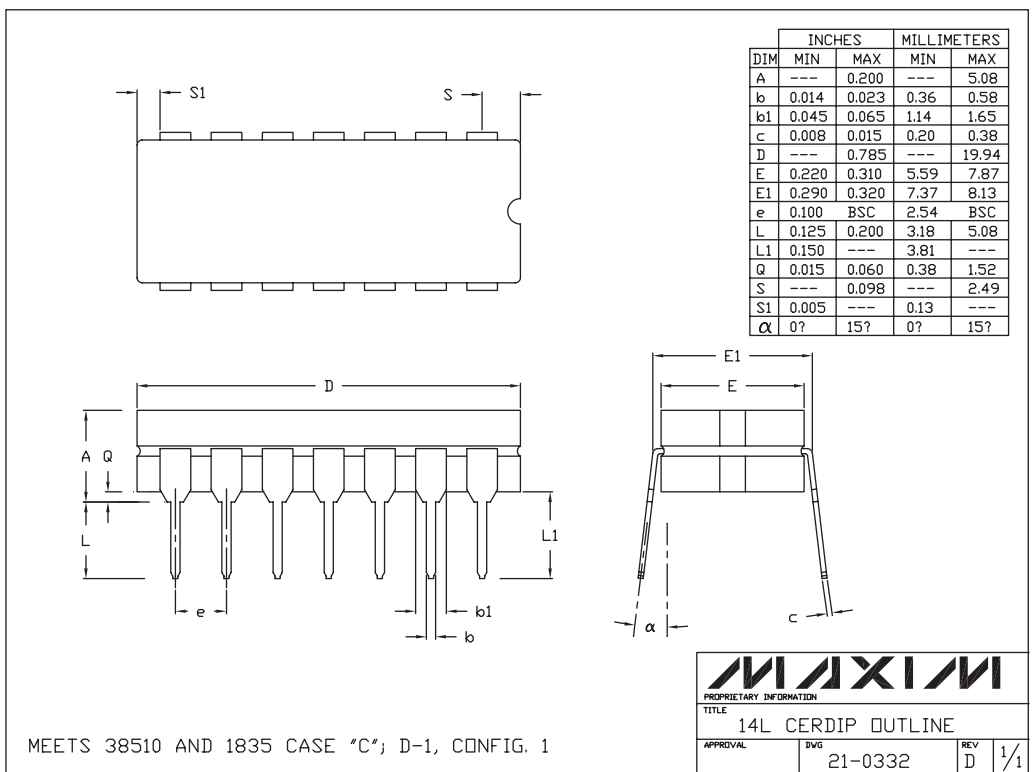

14L CERDIP.EPS

MAX304(A)/DG305(A)/DG306(A)/DG307(A)

MAXIM
 PROPRIETARY INFORMATION
 TITLE: 14L CERDIP OUTLINE
 APPROVAL: _____ DWG: 21-0332 REV: D 1/1

Maxim cannot assume responsibility for use of any circuitry other than circuitry entirely embodied in a Maxim product. No circuit patent licenses are implied. Maxim reserves the right to change the circuitry and specifications without notice at any time.

Maxim Integrated Products, 120 San Gabriel Drive, Sunnyvale, CA 94086 408-737-7600 9

© 2004 Maxim Integrated Products Printed USA MAXIM is a registered trademark of Maxim Integrated Products.