

# GaN on Silicon General Purpose Amplifier

## DC - 2.5 GHz, 48 V, 45 W



NPT2021

Rev. V3

### Features

- GaN on Si HEMT D-Mode Amplifier
- Suitable for Linear & Saturated Applications
- Tunable from DC - 2.5 GHz
- 48 V Operation
- 16.5 dB Gain @ 2.5 GHz
- 55% Drain Efficiency @ 2.5 GHz
- 100% RF Tested
- TO-272 Package
- RoHS\* Compliant and 260°C Reflow Compatible



### Description

The NPT2021 GaN on silicon HEMT D-Mode amplifier optimized for DC - 2.5 GHz operation. This device supports CW, pulsed, and linear operation with output power levels to 45 W in an industry standard plastic package with bolt down flange.

The NPT2021 is ideally suited for defense communications, land mobile radio, avionics, wireless infrastructure, ISM applications and VHF/UHF/L/S-band radar.

Built using the SIGANTIC® process - a proprietary GaN-on-Silicon technology.

### Functional Schematic

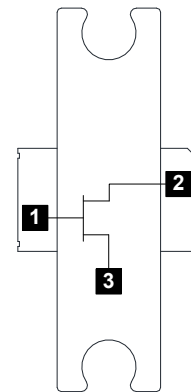

### Ordering Information

Part Number	Package
NPT2021	Bulk Quantity
NPT2021-SMB1	Sample Board
NPT2021-TR0250	Tape & Reel

### Pin Configuration

Pin #	Pin Name	Function
1	RF <sub>IN</sub> / V <sub>G</sub>	RF Input / Gate
2	RF <sub>OUT</sub> / V <sub>D</sub>	RF Output / Drain
3	Pad <sup>1</sup>	Ground / Source

1. The exposed pad centered on the package bottom must be connected to RF and DC ground. This path must also provide a low thermal resistance heat path.

\* Restrictions on Hazardous Substances, compliant to current RoHS EU directive.

# GaN on Silicon General Purpose Amplifier

## DC - 2.5 GHz, 48 V, 45 W



NPT2021

Rev. V3

### RF Electrical Specifications: $T_C = 25^\circ\text{C}$ , $V_{DS} = 48\text{ V}$ , $I_{DQ} = 350\text{ mA}$

Parameter	Test Conditions	Symbol	Min.	Typ.	Max.	Units
Small Signal Gain	CW, 2.5 GHz	$G_{SS}$	-	14.2	-	dB
Saturated Output Power	CW, 2.5 GHz	$P_{SAT}$	-	47.5	-	dBm
Drain Efficiency at Saturation	CW, 2.5 GHz	$\eta_{SAT}$	-	65	-	%
Power Gain	2.5 GHz, $P_{OUT} = 45\text{ W}$	$G_P$	12	12.8	-	dB
Drain Efficiency	2.5 GHz, $P_{OUT} = 45\text{ W}$	$\eta$	45	50	-	%
Ruggedness: Output Mismatch	All phase angles	$\Psi$	VSWR = 15:1, No Device Damage			

### DC Electrical Characteristics: $T_C = 25^\circ\text{C}$

Parameter	Test Conditions	Symbol	Min.	Typ.	Max.	Units
Drain-Source Leakage Current	$V_{GS} = -8\text{ V}$ , $V_{DS} = 160\text{ V}$	$I_{DLK}$	-	-	14	mA
Gate-Source Leakage Current	$V_{GS} = -8\text{ V}$ , $V_{DS} = 0\text{ V}$	$I_{GLK}$	-	-	7	mA
Gate Threshold Voltage	$V_{DS} = 48\text{ V}$ , $I_D = 14\text{ mA}$	$V_T$	-2.5	-1.8	-0.5	V
Gate Quiescent Voltage	$V_{DS} = 48\text{ V}$ , $I_D = 350\text{ mA}$	$V_{GSQ}$	-2.1	-1.5	-0.3	V
On Resistance	$V_{DS} = 2\text{ V}$ , $I_D = 105\text{ mA}$	$R_{ON}$	-	0.34	-	$\Omega$
Saturated Drain Current	$V_{DS} = 7\text{ V}$ pulsed, pulse width 300 $\mu\text{s}$	$I_{D(SAT)}$	-	8.2	-	A

### Absolute Maximum Ratings<sup>2,3,4</sup>

Parameter	Absolute Maximum
Drain Source Voltage, $V_{DS}$	160 V
Gate Source Voltage, $V_{GS}$	-10 to 3 V
Gate Current, $I_G$	24 mA
Junction Temperature, $T_J$	+200°C
Operating Temperature	-40°C to +85°C
Storage Temperature	-65°C to +150°C

2. Exceeding any one or combination of these limits may cause permanent damage to this device.
3. MACOM does not recommend sustained operation near these survivability limits.
4. Operating at nominal conditions with  $T_J \leq 200^\circ\text{C}$  will ensure  $\text{MTTF} > 1 \times 10^6$  hours.

### Thermal Characteristics<sup>5</sup>

Parameter	Test Conditions	Symbol	Typical	Units
Thermal Resistance	$V_{DS} = 48 \text{ V}, T_J = 200^\circ\text{C}$	$R_{\theta JC}$	1.60	°C/W

5. Junction temperature ( $T_J$ ) measured using IR Microscopy. Case temperature measured using thermocouple embedded in heat-sink.

### Handling Procedures

Please observe the following precautions to avoid damage:

### Static Sensitivity

Gallium Nitride Circuits are sensitive to electrostatic discharge (ESD) and can be damaged by static electricity. Proper ESD control techniques should be used when handling these HBM Class 1B devices.

**Load-Pull Performance:  $V_{DS} = 48\text{ V}$ ,  $I_{DQ} = 350\text{ mA}$ ,  $T_C = 25^\circ\text{C}$**

**Reference Plane at Device Leads, CW Drain Efficiency and Output Power Tradeoff Impedance**

Frequency (MHz)	$Z_S$ (W)	$Z_L$ (W)	$P_{SAT}$ (W)	$G_{SS}$ (dB)	Drain Efficiency @ $P_{SAT}$ (%)
900	$1.1 + j0.7$	$7.3 + j5.5$	74	24	68
2000	$1.4 - j6.1$	$2.9 + j2.4$	65	17	68
2500	$1.5 - j7.6$	$2.3 + j0.6$	64	14	65

### Impedance Reference

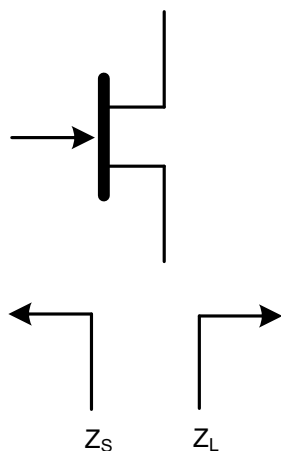

### $Z_S$ and $Z_L$ vs. Frequency

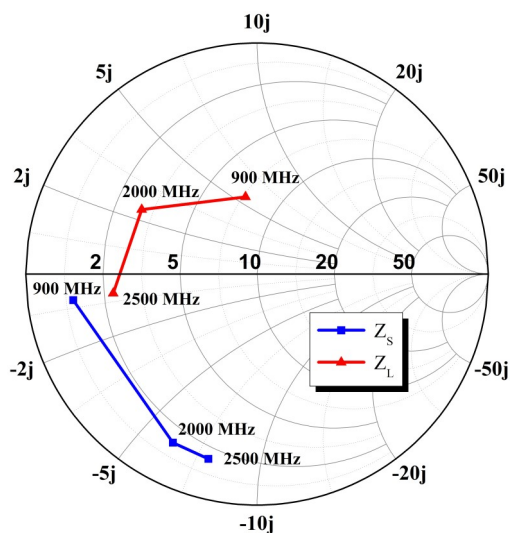

### Gain vs. Output Power

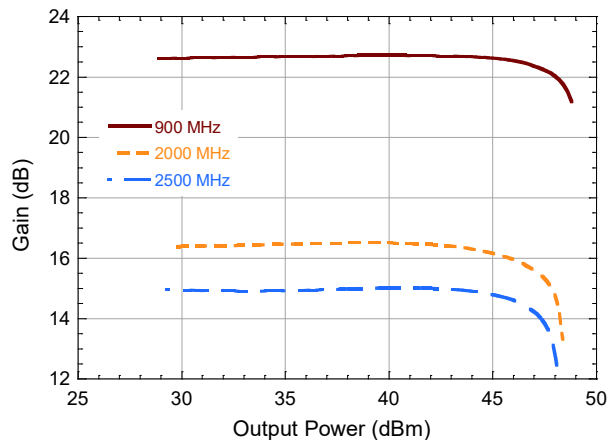

### Drain Efficiency vs. Output Power

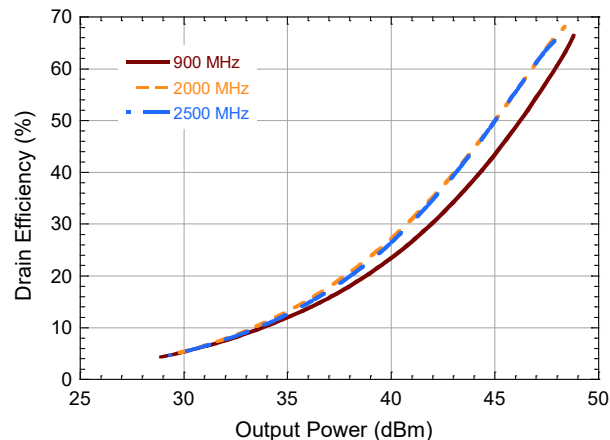

## Evaluation Board and Recommended Tuning Solution

### 2.5 GHz Narrowband Circuit

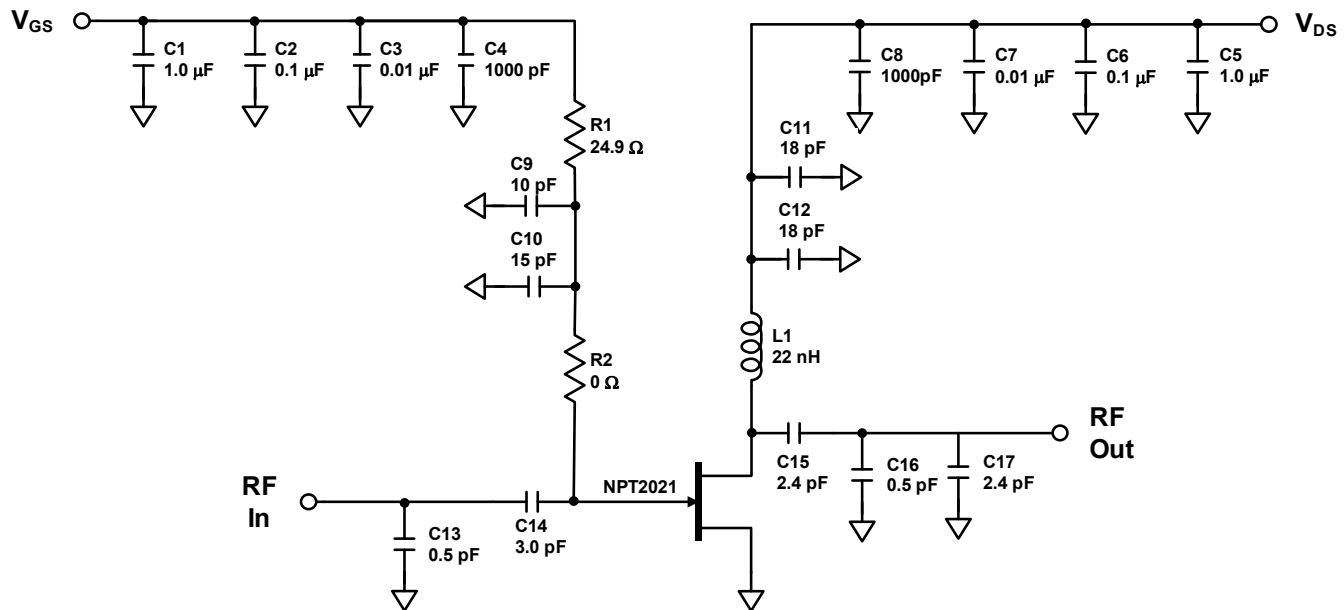

### Description

Parts measured on evaluation board (30-mil thick RO4350). The PCB's electrical and thermal ground is provided using a standard-plated densely packed via hole array (see recommended via pattern).

Matching is provided using a combination of lumped elements and transmission lines as shown in the simplified schematic above. Recommended tuning solution component placement, transmission lines, and details are shown on the next page.

### Bias Sequencing

#### Turning the device ON

1. Set  $V_{GS}$  to the pinch-off ( $V_P$ ), typically -5 V.
2. Turn on  $V_{DS}$  to nominal voltage (48 V).
3. Increase  $V_{GS}$  until the  $I_{DS}$  current is reached.
4. Apply RF power to desired level.

#### Turning the device OFF

1. Turn the RF power off.
2. Decrease  $V_{GS}$  down to  $V_P$ .
3. Decrease  $V_{DS}$  down to 0 V.
4. Turn off  $V_{GS}$ .

**Evaluation Board and Recommended Tuning Solution**  
2.5 GHz Narrowband Circuit

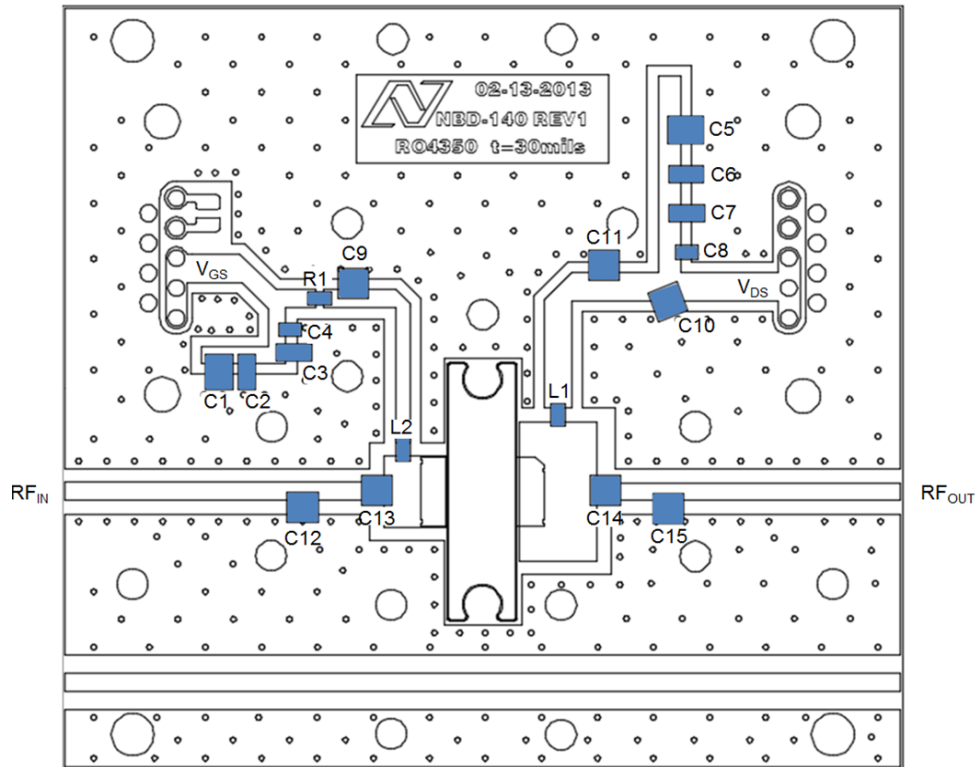

**Parts List**

Reference	Value	Tolerance	Manufacturer	Part Number
C1, C5	1.0 $\mu$ F	10 %	AVX	1210C105KAT2A
C2, C6	0.1 $\mu$ F	10 %	Kemet	C1206C104K1RACTU
C3, C7	0.01 $\mu$ F	10 %	AVX	12061C103KAT2A
C4, C8	1000 pF	10 %	Kemet	C0805C102K1RACTU
C9	10 pF	5 %	ATC	ATC800A100J
C10, C11	18 pF	10 %	ATC	ATC800B180K
C12	3.6 pF	0.1 pF	Murata	GQM22M5C2H3R6BB01
C13	1.5 pF	0.1 pF	Murata	GQM22M5C2H1R5BB01
C14, C15	2.4 pF	0.1 pF	ATC	ATC800B2R4B
L1, L2	22 nH	5%	Coilcraft	0807SQ-22N_LB
R1	24.9 $\Omega$	1 %	Panasonic	ERJ-SIDF49R9U-ND
PCB	Rogers RO4350, $\epsilon_r = 3.5$ , 30 mil			

**Typical Performance as measured in the 2.5 GHz evaluation board:**  
**CW,  $V_{DS} = 48\text{ V}$ ,  $I_{DQ} = 350\text{ mA}$  (unless noted)**

**Gain vs. Output Power over Temperature**

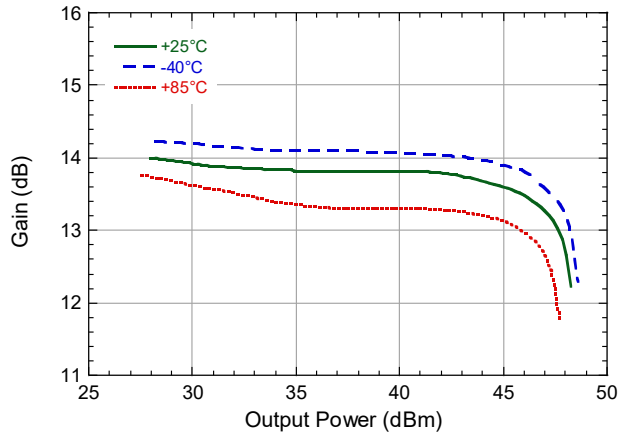

**Drain Efficiency vs. Output Power over Temperature**

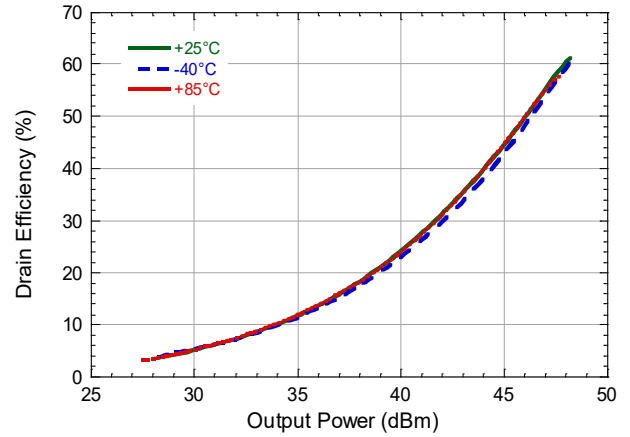

**Quiescent  $V_{GS}$  vs. Temperature**

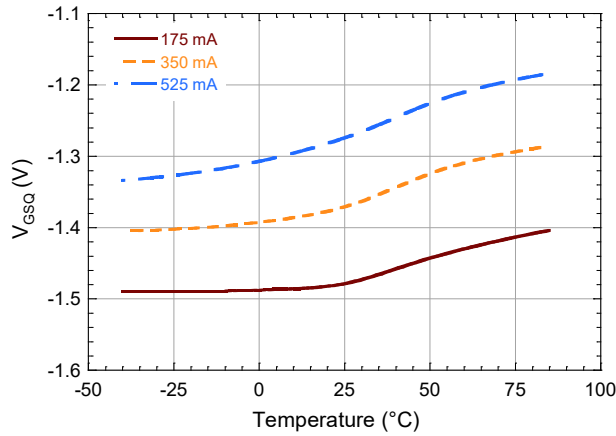

Typical 2-Tone Performance as measured in the 2.5 GHz evaluation board:  
 1 MHz Tone Spacing,  $V_{DS} = 48\text{ V}$ ,  $I_{DQ} = 350\text{ mA}$ ,  $T_C = 25^\circ\text{C}$  (unless noted)

2-Tone IMD3 vs. Output Power vs. Quiescent Current

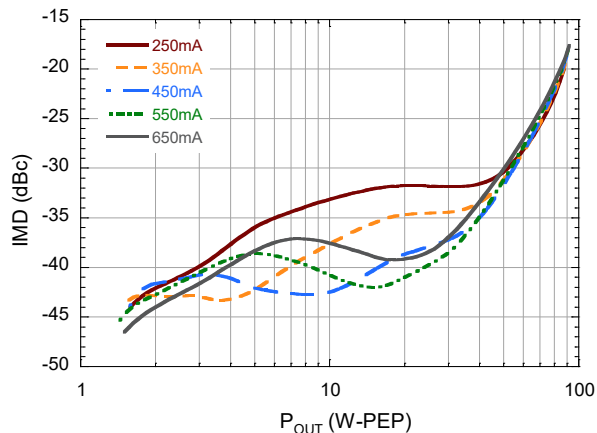

2-Tone Gain vs. Output Power vs. Quiescent Current

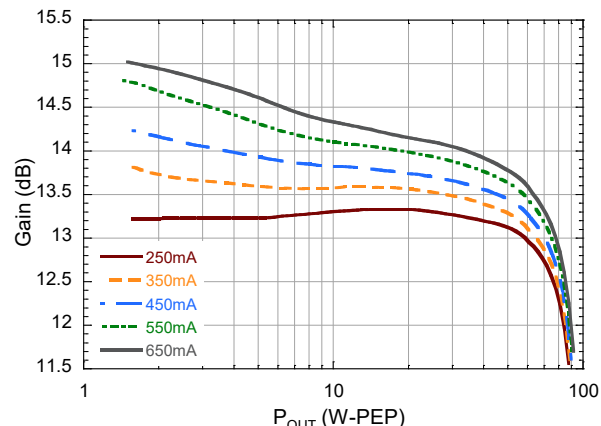

2-Tone IMD vs. Output Power

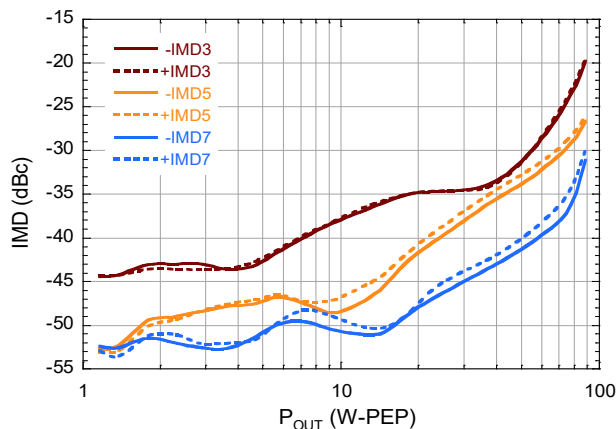



# GaN on Silicon General Purpose Amplifier

## DC - 2.5 GHz, 48 V, 45 W



NPT2021

Rev. V3

### TO-272-2 Plastic Package<sup>†</sup>

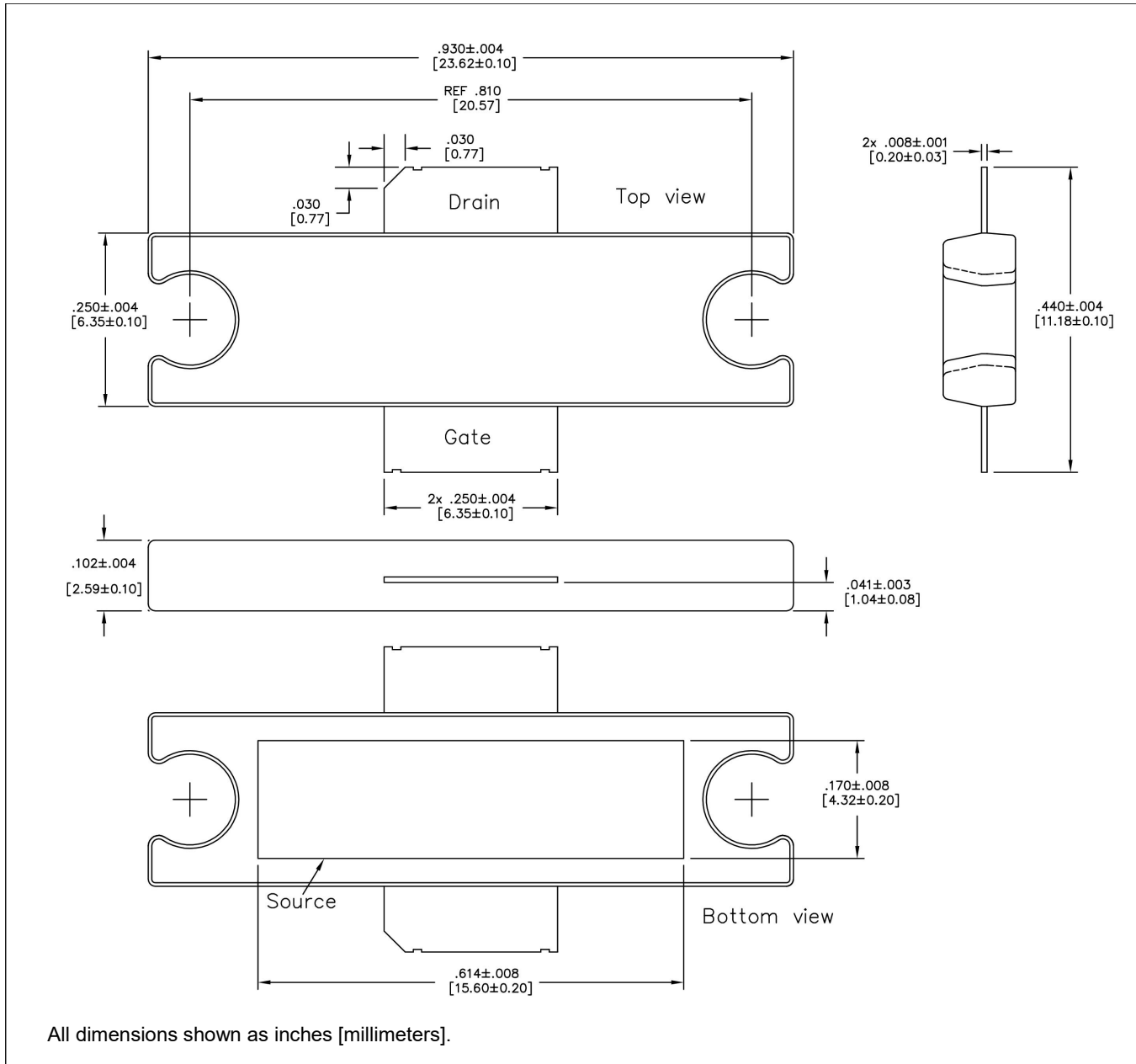

<sup>†</sup> Meets JEDEC moisture sensitivity level 3 requirements.  
Plating is Matte Sn.

MACOM Technology Solutions Inc. All rights reserved.

Information in this document is provided in connection with MACOM Technology Solutions Inc ("MACOM") products. These materials are provided by MACOM as a service to its customers and may be used for informational purposes only. Except as provided in MACOM's Terms and Conditions of Sale for such products or in any separate agreement related to this document, MACOM assumes no liability whatsoever. MACOM assumes no responsibility for errors or omissions in these materials. MACOM may make changes to specifications and product descriptions at any time, without notice. MACOM makes no commitment to update the information and shall have no responsibility whatsoever for conflicts or incompatibilities arising from future changes to its specifications and product descriptions. No license, express or implied, by estoppels or otherwise, to any intellectual property rights is granted by this document.

THESE MATERIALS ARE PROVIDED "AS IS" WITHOUT WARRANTY OF ANY KIND, EITHER EXPRESS OR IMPLIED, RELATING TO SALE AND/OR USE OF MACOM PRODUCTS INCLUDING LIABILITY OR WARRANTIES RELATING TO FITNESS FOR A PARTICULAR PURPOSE, CONSEQUENTIAL OR INCIDENTAL DAMAGES, MERCHANTABILITY, OR INFRINGEMENT OF ANY PATENT, COPYRIGHT OR OTHER INTELLECTUAL PROPERTY RIGHT. MACOM FURTHER DOES NOT WARRANT THE ACCURACY OR COMPLETENESS OF THE INFORMATION, TEXT, GRAPHICS OR OTHER ITEMS CONTAINED WITHIN THESE MATERIALS. MACOM SHALL NOT BE LIABLE FOR ANY SPECIAL, INDIRECT, INCIDENTAL, OR CONSEQUENTIAL DAMAGES, INCLUDING WITHOUT LIMITATION, LOST REVENUES OR LOST PROFITS, WHICH MAY RESULT FROM THE USE OF THESE MATERIALS.

MACOM products are not intended for use in medical, lifesaving or life sustaining applications. MACOM customers using or selling MACOM products for use in such applications do so at their own risk and agree to fully indemnify MACOM for any damages resulting from such improper use or sale.