

2-Way 0° Power Divider 5 - 1218 MHz

Rev. V2

Features

- 2-Way 0 Degree
- Surface Mount Package
- Available on Tape and Reel
- 260°C Reflow Compatible
- RoHS Compliant and Pb free
- Isolation optimized for +55°C operation

Description

The MAPD-011053 is a 2 way 0 degree power divider in a low cost surface mount package.

Ideally suited for all CATV Broadband and FTTx applications. This part can be optimized for isolation performance at +25°C also. Please see the application section page.

Functional Schematic

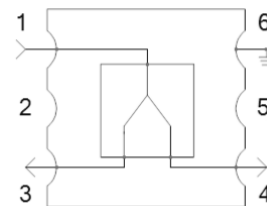

Pin Configuration³

Pin #	Function	Pin #	Function
1	Input	4	Output 2
2, 5	External Capacitor	6	Ground
3	Output 1		

3. MACOM recommends connecting unused package pins to ground.

Electrical Specifications: $T_A = 25^\circ\text{C}$, $Z_0 = 75 \Omega$, $P_{IN} = 0 \text{ dBm}$

Parameter	Frequency Test Conditions (MHz)	Units	Min.	Typ.	Max.
Power Split	—	dB	—	3	—
Insertion Loss 1 (pin 1 - pin 3)	5 - 700	dB	—	0.3	0.5
	700 - 1218			0.5	0.8
Insertion Loss 2 (pin 1 - pin 4)	5 - 700	dB	—	0.5	0.9
	700 - 1218			1.3	1.8
Amplitude Balance	5 - 700	dB	—	0.3	± 0.6
	700 - 1218			0.9	± 1.25
Phase Balance	5 - 700	degree	—	3	± 5
	700 - 1218			5	± 6
Input Return Loss (pin 1)	5 - 700	dB	23	30	—
	700 - 1218		17	22	
Output Return Loss (pin 3)	5 - 700	dB	19	24	—
	700 - 1218		12	15	
Output Return Loss (pin 4)	5 - 700	dB	18	24	—
	700 - 1218		12	25	
Isolation (pin 4 - pin 3)	5 - 70	dB	28	35	—
	70 - 130		35	44	
	130 - 700		32	41	
	700 - 1218		19	26	

Ordering Information^{1,2}

Part Number	Description
MAPD-011053	2000 piece reel
MAPD-011053-TB	sample board

1. Reference Application Note M513 for reel size information.
2. All sample boards include 5 loose parts.

1

MACOM Technology Solutions Inc. (MACOM) and its affiliates reserve the right to make changes to the product(s) or information contained herein without notice. Visit www.macom.com for additional data sheets and product information.

For further information and support please visit <https://www.macom.com/support>

2-Way 0° Power Divider 5 - 1218 MHz

Rev. V2

Recommended Maximum Ratings^{4,5}

Parameter	Absolute Maximum
Input RF Power ⁶	2 W
DC Current	500 mA
Operating Temperature	-40°C to +85°C

4. Exceeding any one or combination of these limits may cause permanent damage to this device.
5. MACOM does not recommend sustained operation near these survivability limits.
6. Specified at 25°C only.

Component List

Part	Value	Case Style
C1, C2	0.5 pF	0402
R1	180 Ω	0402
R2	9.1 Ω	0402
L1	22 nH	0402

Recommended Board Layout^{7,8,9}

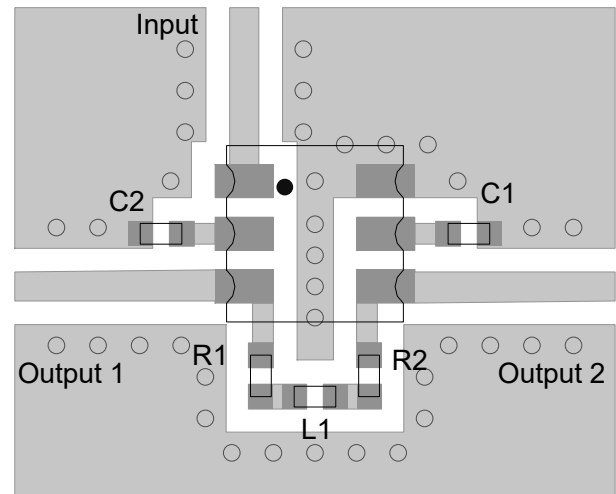

7. Dimensions in mm.
8. Tolerance: ± 0.2 mm unless otherwise noted.
9. Recommended PCB layout shown above uses 1.6 mm FR4, CPWG transmission line. Width 0.70 mm, Gap 0.57 mm.

Application Schematic

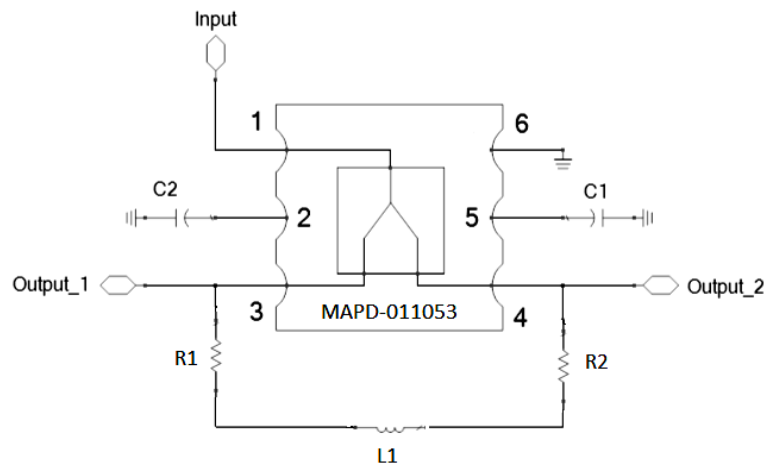

Typical Performance Curves

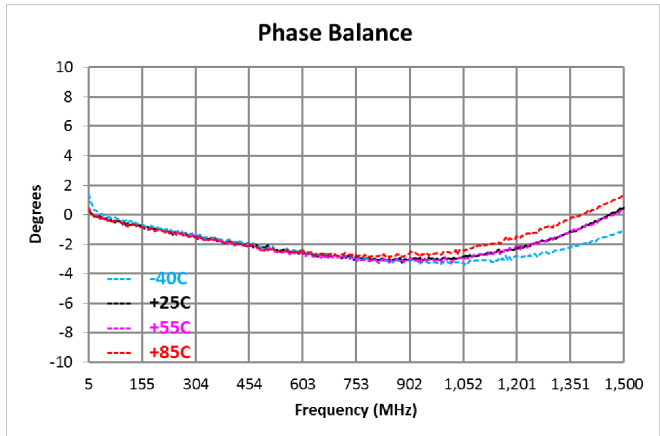
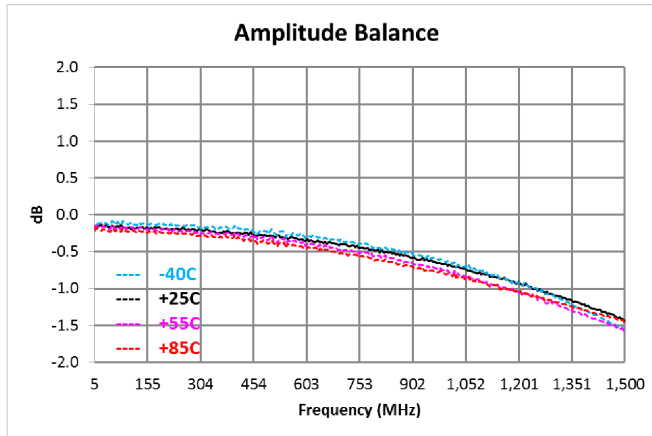
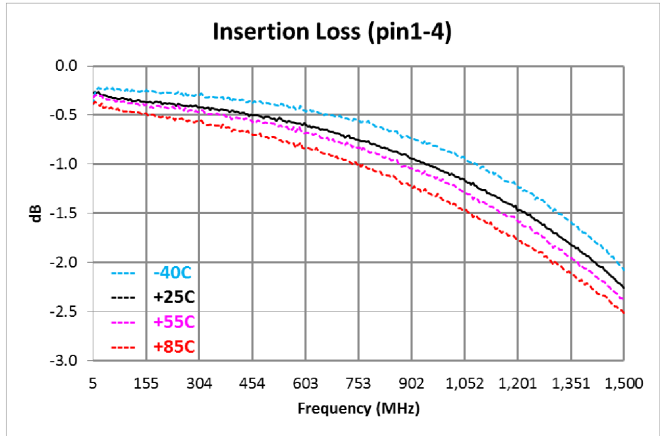
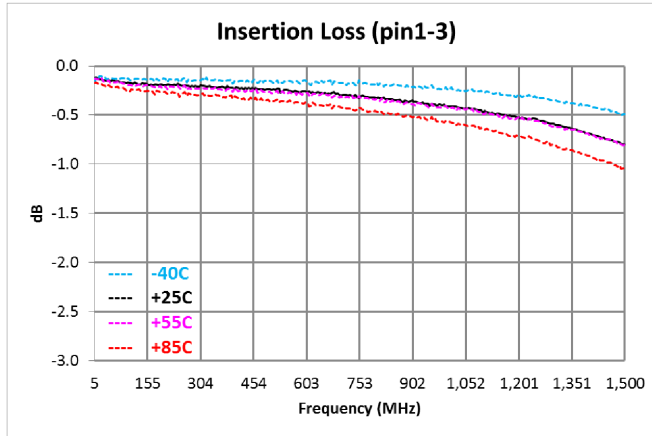

Typical Performance Curves

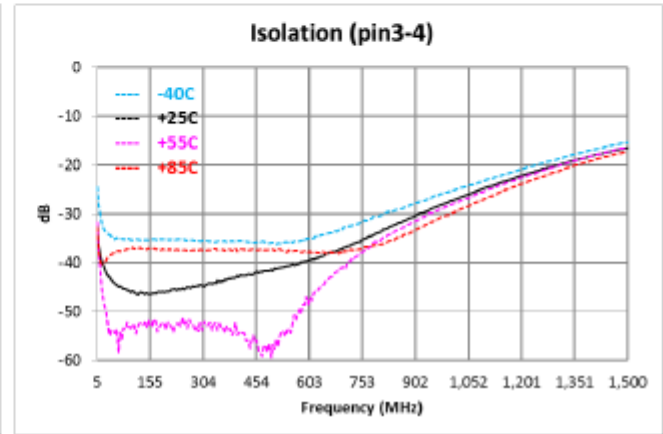
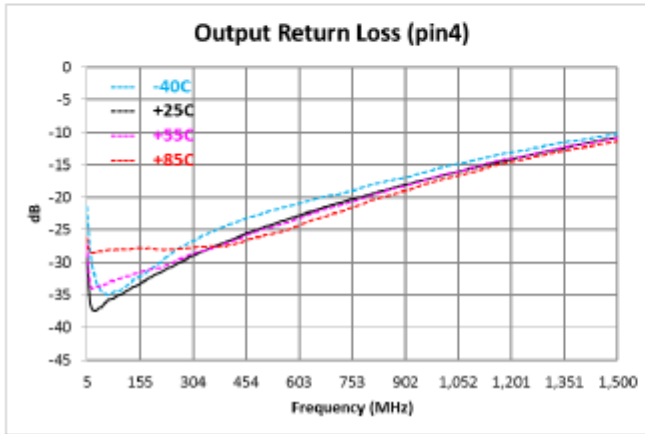
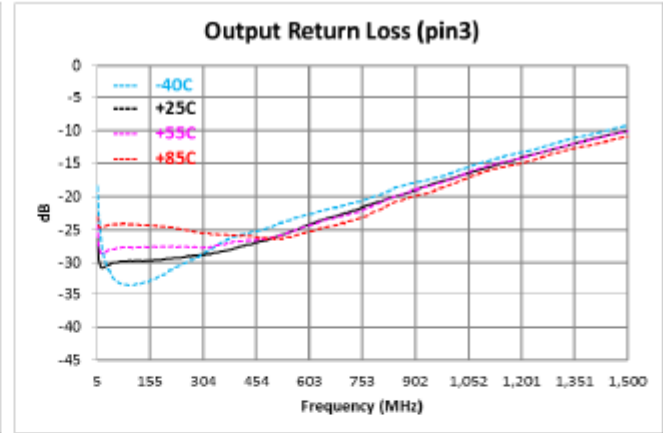
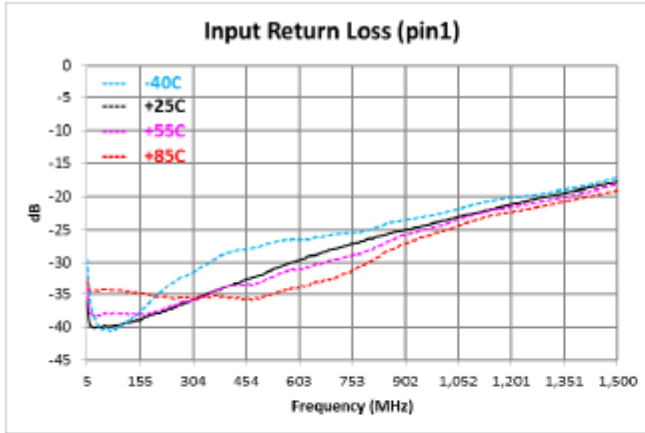

Recommended Land Pattern

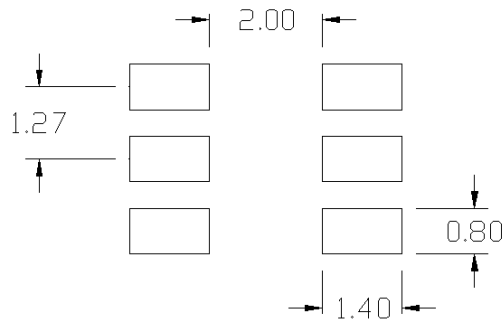

Part Outline Drawing^{10,11,12,13}

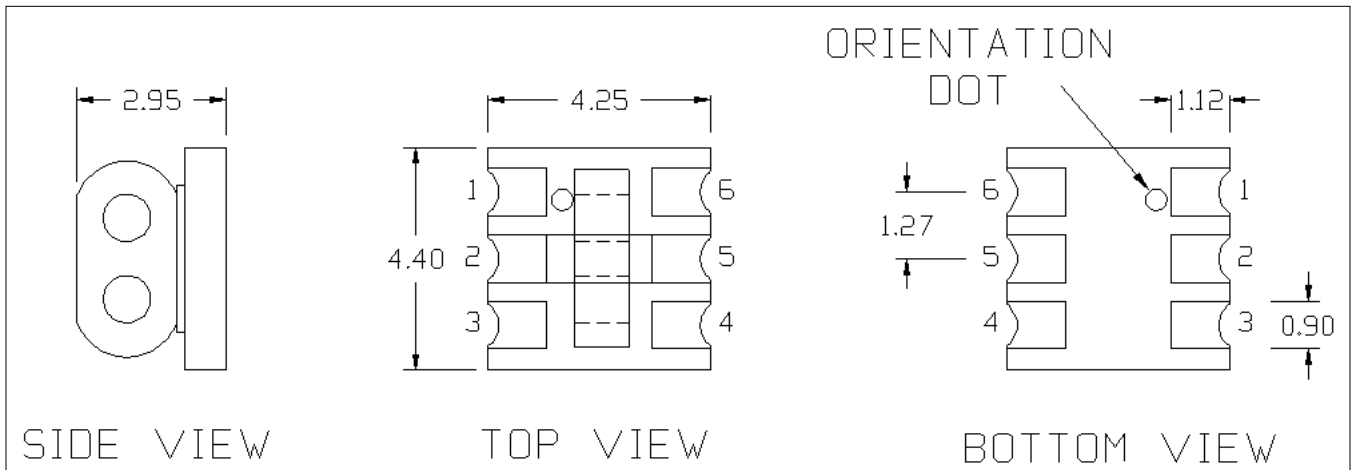

- 10. Dimensions in mm.
- 11. Tolerance: ± 0.2 mm unless otherwise noted.
- 12. Model number and lot code printed on reel.
- 13. Finish: Electroless Nickel Immersion Gold.

Carrier Tape Orientation

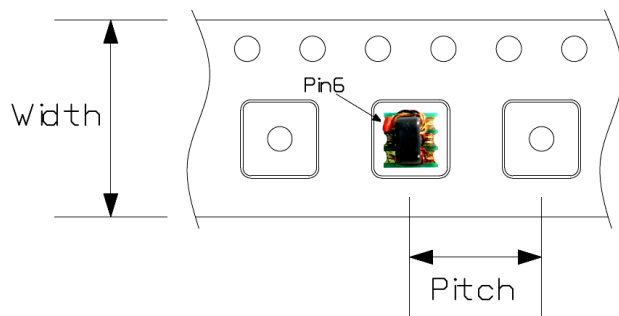

Tape & Reel Information

Parameter	Units	Value
Qty Per Reel	-	2000
Reel Size	mm	330
Tape Width	mm	12.00
Pitch	mm	8.00
Orientation	-	F31
Reference Application Note ANI-019 for orientation		

Application Section: 25°C Isolation Optimization

Recommended Board Layout

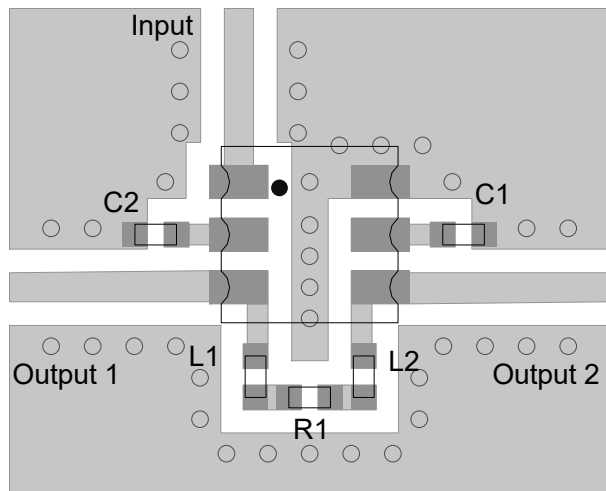

Component List

Part	Value	Case Style
C1, C2	0.5 pF	0402
L1, L2	10 nH	0402
R1	180 Ω	0402

Application Schematic

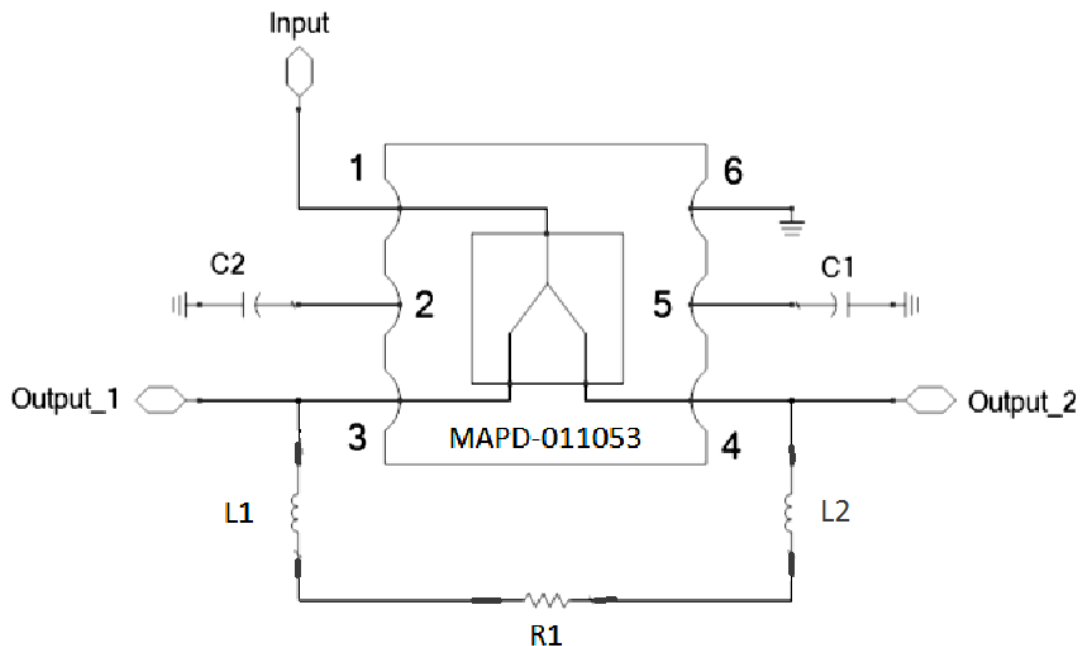

2-Way 0° Power Divider 5 - 1218 MHz

Rev. V2

Electrical Specifications: $T_A = 25^\circ\text{C}$, $Z_0 = 75 \Omega$, $P_{IN} = 0 \text{ dBm}$

Parameter	Frequency Test Conditions (MHz)	Units	Min.	Typ.	Max.
Power Split	—	dB	—	3	—
Insertion Loss 1 (pin 1 - pin 3)	5 - 700 700 - 1218	dB	—	0.25 0.40	—
Insertion Loss 2 (pin 1 - pin 4)	5 - 700 700 - 1218	dB	—	0.6 1.2	—
Amplitude Balance	5 - 700 700 - 1218	dB	—	0.3 0.8	—
Phase Balance	5 - 700 700 - 1218	degree	—	2 3	—
Input Return Loss (pin 1)	5 - 700 700 - 1218	dB	—	34 24	—
Output Return Loss (pin 3)	5 - 700 700 - 1218	dB	—	25 20	—
Output Return Loss (pin 4)	5 - 700 700 - 1218	dB	—	26 18	—
Isolation (pin 4 - pin 3)	5 - 100 100 - 700 700 - 1218	dB	—	35 44 34	—

Application Section: 25°C Isolation Optimization

Typical Performance Curves

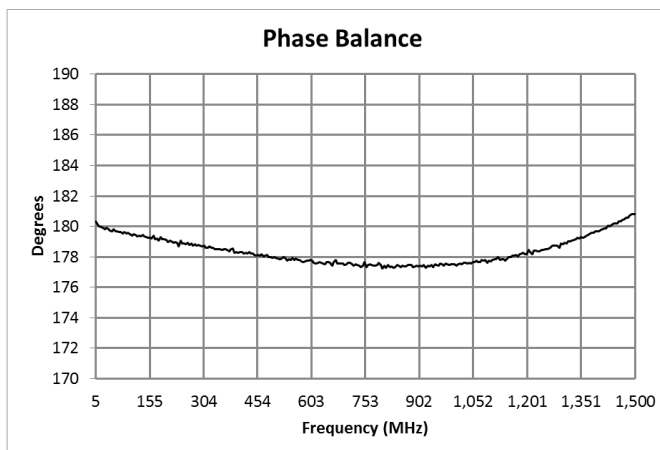
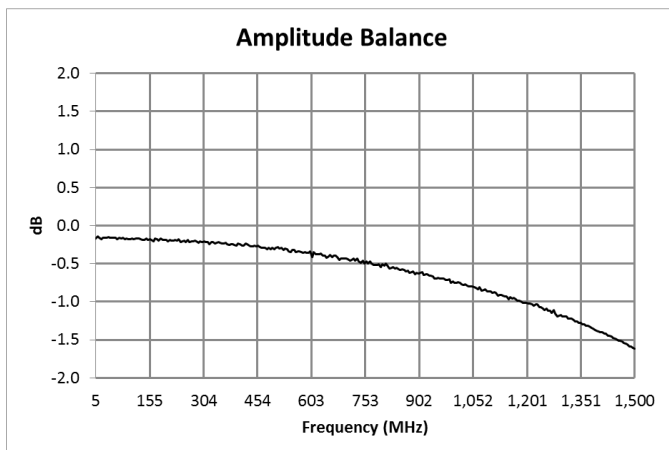
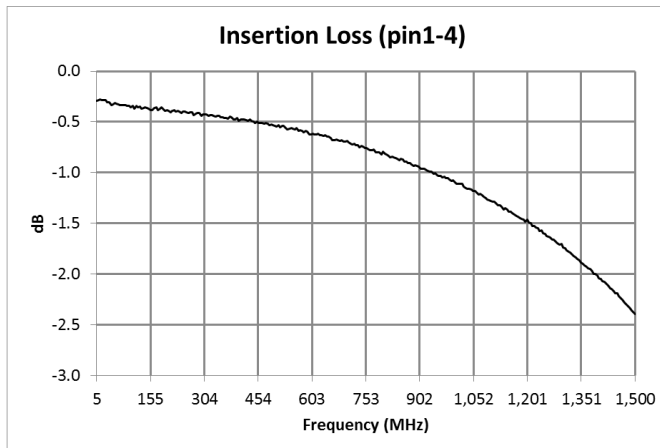
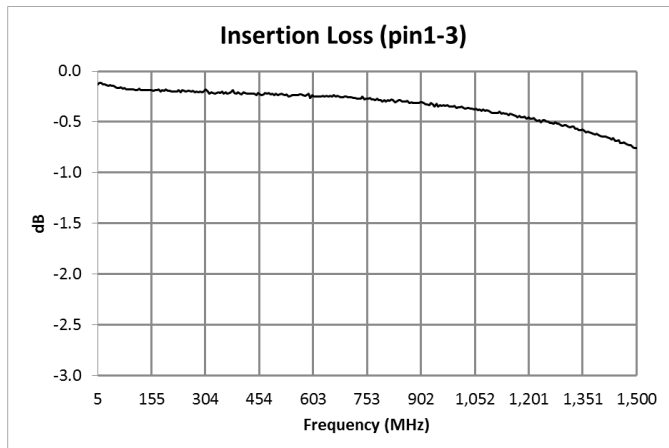

Application Section: 25°C Isolation Optimization

Typical Performance Curves

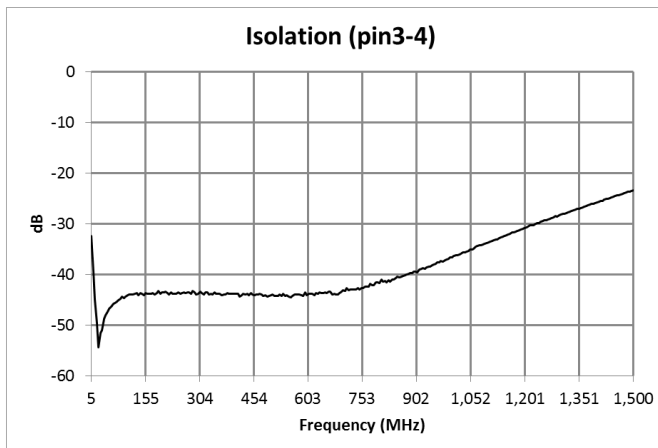
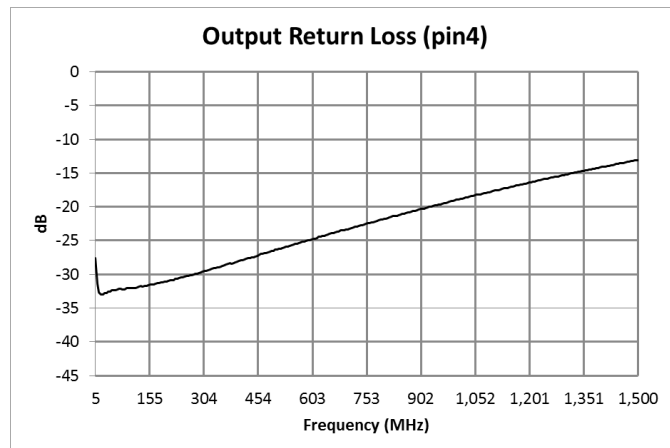
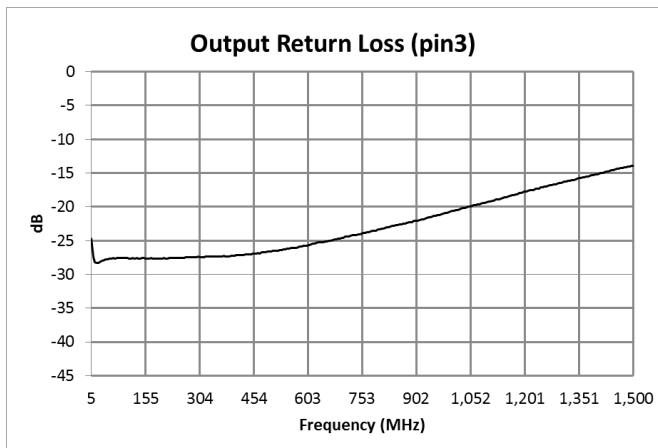
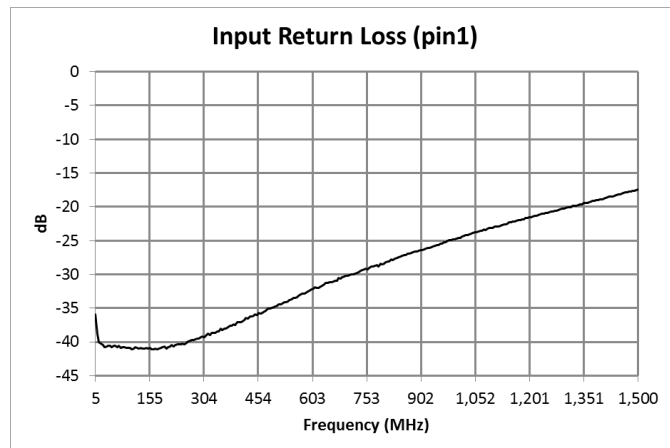

MACOM Technology Solutions Inc. All rights reserved.

Information in this document is provided in connection with MACOM Technology Solutions Inc ("MACOM") products. These materials are provided by MACOM as a service to its customers and may be used for informational purposes only. Except as provided in MACOM's Terms and Conditions of Sale for such products or in any separate agreement related to this document, MACOM assumes no liability whatsoever. MACOM assumes no responsibility for errors or omissions in these materials. MACOM may make changes to specifications and product descriptions at any time, without notice. MACOM makes no commitment to update the information and shall have no responsibility whatsoever for conflicts or incompatibilities arising from future changes to its specifications and product descriptions. No license, express or implied, by estoppels or otherwise, to any intellectual property rights is granted by this document.

THESE MATERIALS ARE PROVIDED "AS IS" WITHOUT WARRANTY OF ANY KIND, EITHER EXPRESS OR IMPLIED, RELATING TO SALE AND/OR USE OF MACOM PRODUCTS INCLUDING LIABILITY OR WARRANTIES RELATING TO FITNESS FOR A PARTICULAR PURPOSE, CONSEQUENTIAL OR INCIDENTAL DAMAGES, MERCHANTABILITY, OR INFRINGEMENT OF ANY PATENT, COPYRIGHT OR OTHER INTELLECTUAL PROPERTY RIGHT. MACOM FURTHER DOES NOT WARRANT THE ACCURACY OR COMPLETENESS OF THE INFORMATION, TEXT, GRAPHICS OR OTHER ITEMS CONTAINED WITHIN THESE MATERIALS. MACOM SHALL NOT BE LIABLE FOR ANY SPECIAL, INDIRECT, INCIDENTAL, OR CONSEQUENTIAL DAMAGES, INCLUDING WITHOUT LIMITATION, LOST REVENUES OR LOST PROFITS, WHICH MAY RESULT FROM THE USE OF THESE MATERIALS.

MACOM products are not intended for use in medical, lifesaving or life sustaining applications. MACOM customers using or selling MACOM products for use in such applications do so at their own risk and agree to fully indemnify MACOM for any damages resulting from such improper use or sale.