

Features

- Input Power: -15 to +15 dBm
- Dynamic Range: 30 dB
- DC supply: 4.5 V, 70 μ A
- Die size: 1.00 \times 0.75 \times 0.1 mm
- Passivated Die
- ESD Protected
- RoHS* Compliant

Description

MADT-011000-DIE is a single-ended, internally-matched power detector with wide frequency range and high dynamic range. The circuit consumes 70 μ A from a 4.5 V supply, while matched detector and reference diodes provide temperature compensation in differential operation.

The 100 μ m thick GaAs die is fully passivated for reliability and ease of handling.

MADT-011000-DIE is well suited for power control in microwave radios, test and measurement equipment, and radar applications.

MADT-011000-DIE is also available in a 3 mm QFN package. Refer to datasheet MADT-011000.

Ordering Information¹

Part Number	Package
MADT-011000-DIE	Vacuum release gel pack ¹
MADT-011000-SB2	Sample Board

1. Die quantity varies.

Functional Schematic

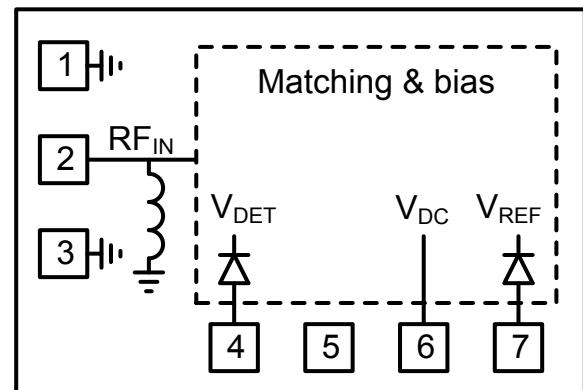

Bond-pad Configuration²

Pin #	Function
1	GND/NC
2	RFIN
3	GND/NC
4	VDET
5	NC
6	VDC
7	VREF
8	GND ²

2. The die backside must be connected to RF, DC and thermal ground.

* Restrictions on Hazardous Substances, European Union Directive 2011/65/EU.

Power Detector Bare Die 5 - 44 GHz

Rev. V1

Electrical Specifications: Freq. = 5 - 44 GHz, $T_A = +25^\circ\text{C}$, $V_{DC} = 4.5\text{ V}$, $Z_0 = 50\ \Omega^3$

Parameter	Test Conditions	Units	Min.	Typ.	Max.
Input Power	—	dBm	-15	—	+15
Dynamic Range	$V_{ref} - V_{det} > 5\text{ mV}$	dB	30	—	—
Vdelta	$V_{delta} = V_{ref} - V_{det}$	mV	5	—	2200
Return Loss	5 - 10 GHz	dB	—	-11	-9
	10 - 12 GHz			-12	-11
	12 - 36 GHz			-11	-9
	36 - 42 GHz			-12	-9
	42 - 44 GHz			-9	-6.5
Supply Voltage	—	V	—	4.5	—
Current Consumption	—	μA	60	70	80

3. All specifications refer to CW input signal.

Absolute Maximum Ratings^{4,5}

Parameter	Absolute Maximum
Input Power	18 dBm
VDC	6 V
Operating Temperature	-55°C to $+85^\circ\text{C}$
Storage Temperature	-65°C to $+150^\circ\text{C}$

- Exceeding any one or combination of these limits may cause permanent damage to this device.
- MACOM does not recommend sustained operation near these survivability limits.

Handling Procedures

Please observe the following precautions to avoid damage:

Static Sensitivity

These electronic devices are sensitive to electrostatic discharge (ESD) and can be damaged by static electricity. Proper ESD control techniques should be used when handling these Class 1B devices.

Application Circuit^{6,7,8}

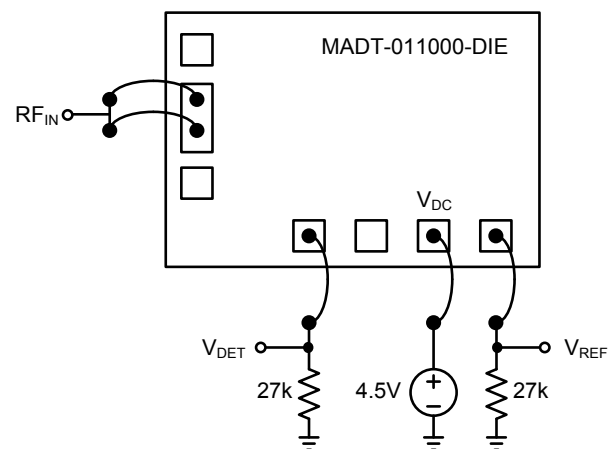

- External 27 k Ω resistors are required for optimum performance.
- Typical $V_{ref} = 0.83\text{V}$
- Attach bare die to PCB or carrier using conductive epoxy

Power Detector Bare Die 5 - 44 GHz

Rev. V1

Typical Performance Curves

Vdelta vs. Input Power, 5 - 10 GHz

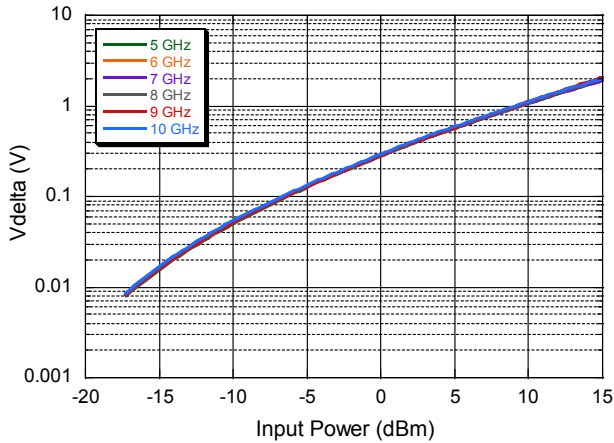

Vdelta vs. Input Power, 11 - 17 GHz

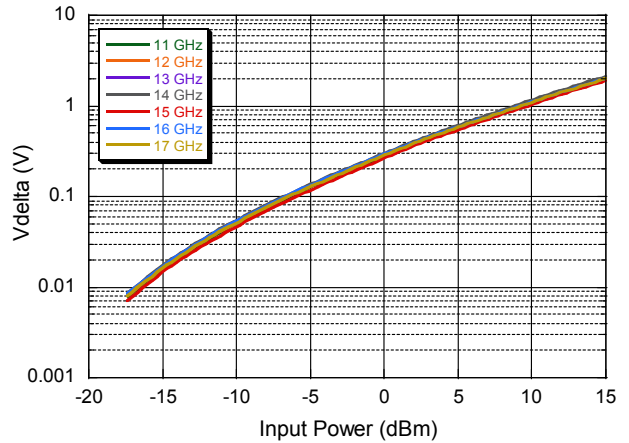

Vdelta vs. Input Power, 18 - 24 GHz

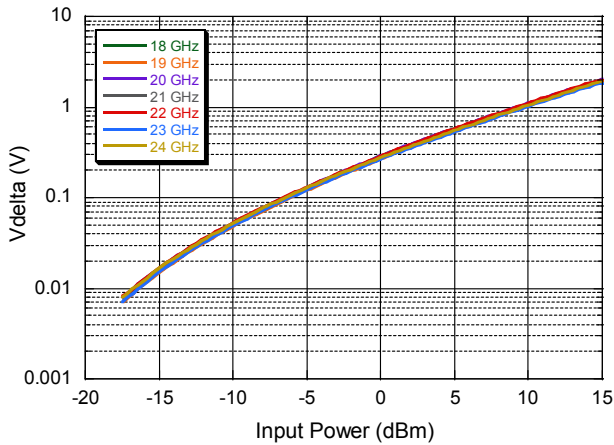

Vdelta vs. Input Power, 25 - 31 GHz

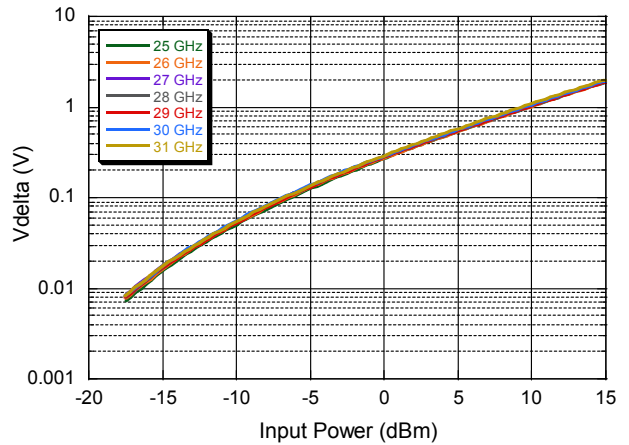

Vdelta vs. Input Power, 32 - 38 GHz

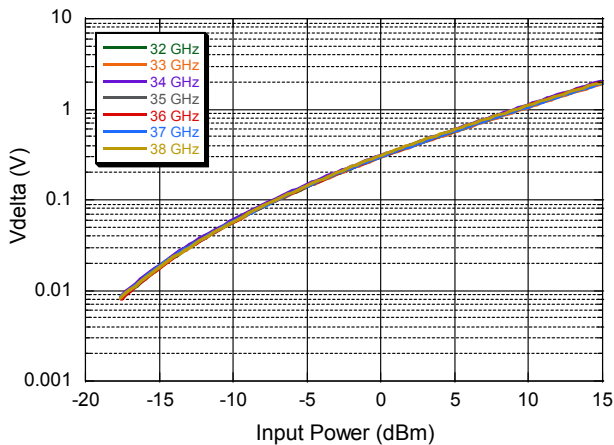

Vdelta vs. Input Power, 39 - 44 GHz

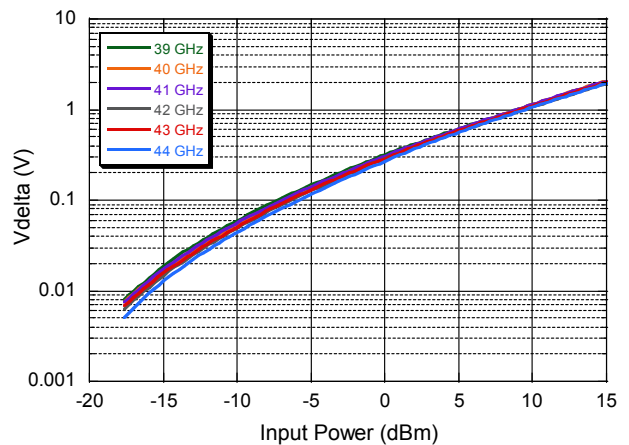

Typical Performance Curves

Vdelta vs. Temperature, 5 GHz

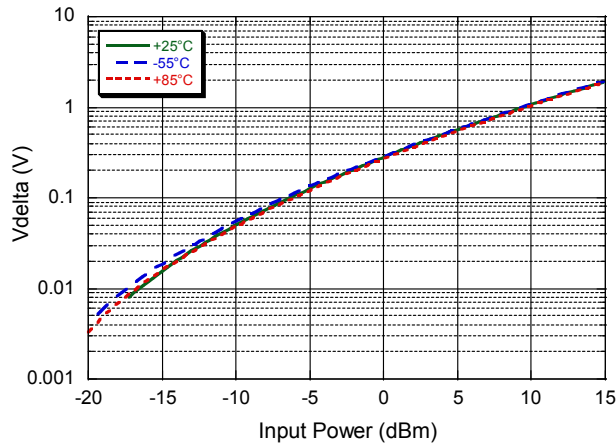

Vdelta vs. Temperature, 15 GHz

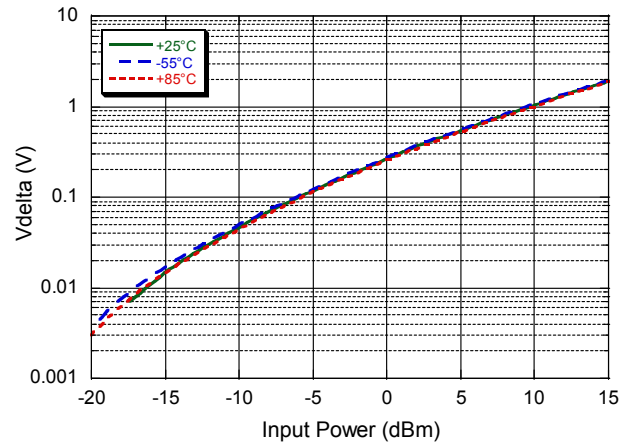

Vdelta vs. Temperature, 23 GHz

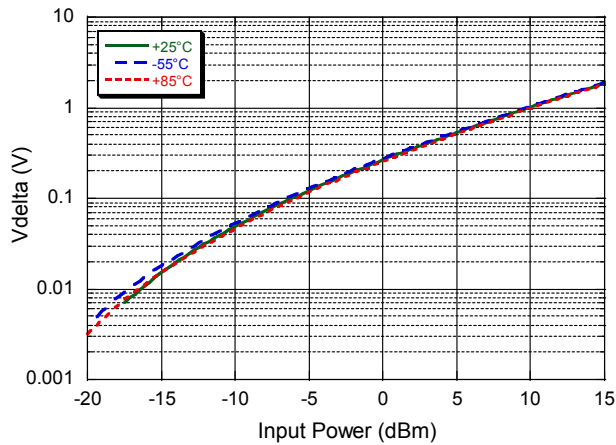

Vdelta vs. Temperature, 30 GHz

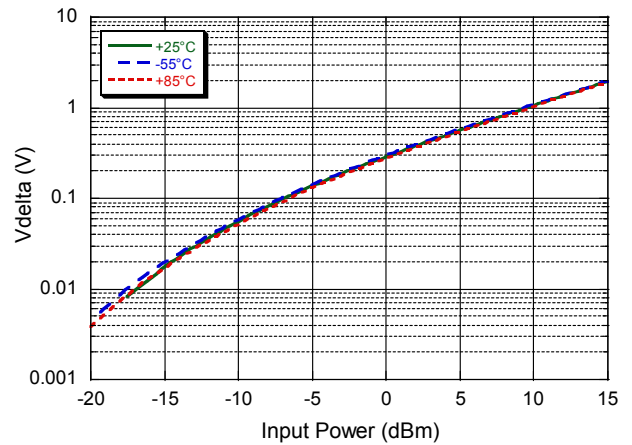

Vdelta vs. Temperature, 38 GHz

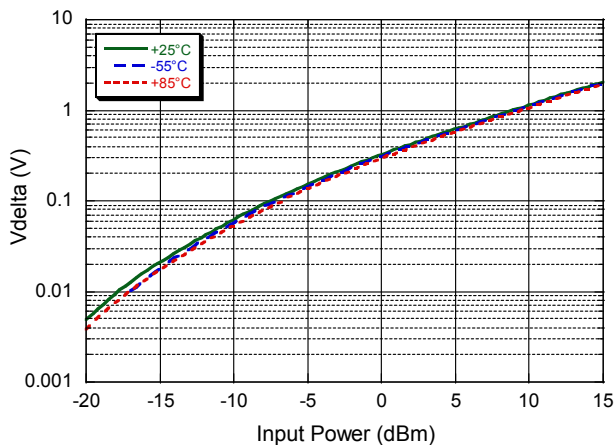

Vdelta vs. Temperature, 44 GHz

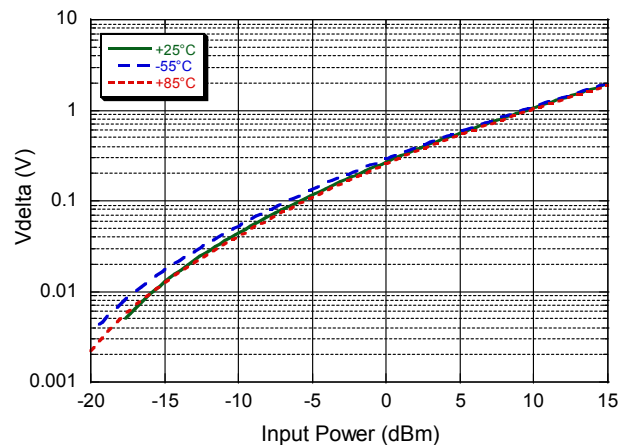

Typical Performance Curves

Vdelta vs. Frequency, $P_{IN} = -15$ dBm

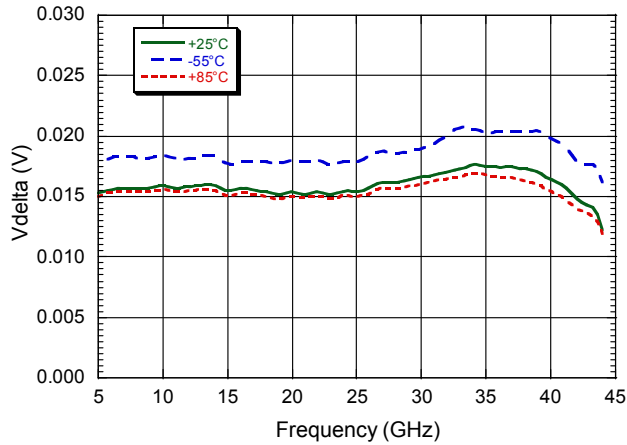

Vdelta vs. Frequency, $P_{IN} = 0$ dBm

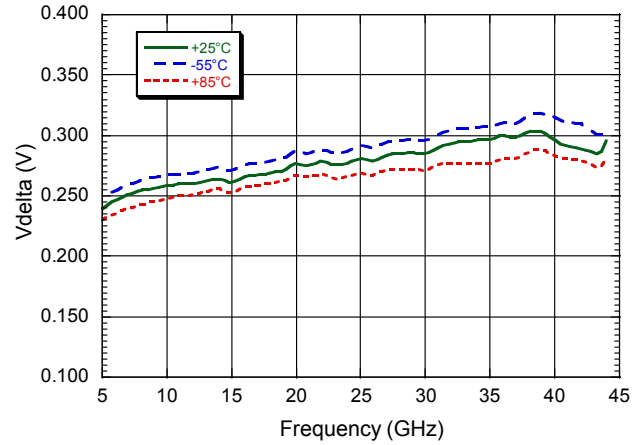

Vdelta vs. Frequency, $P_{IN} = +15$ dBm

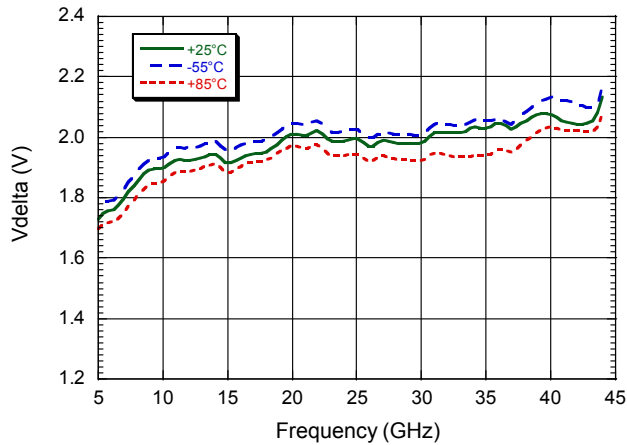

Input Return Loss vs. Frequency

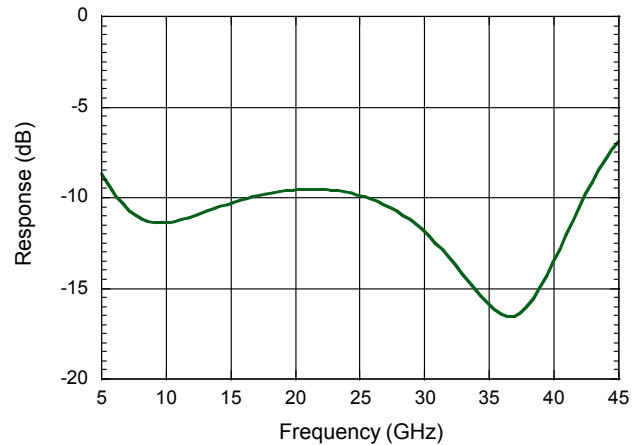

Outline Drawing

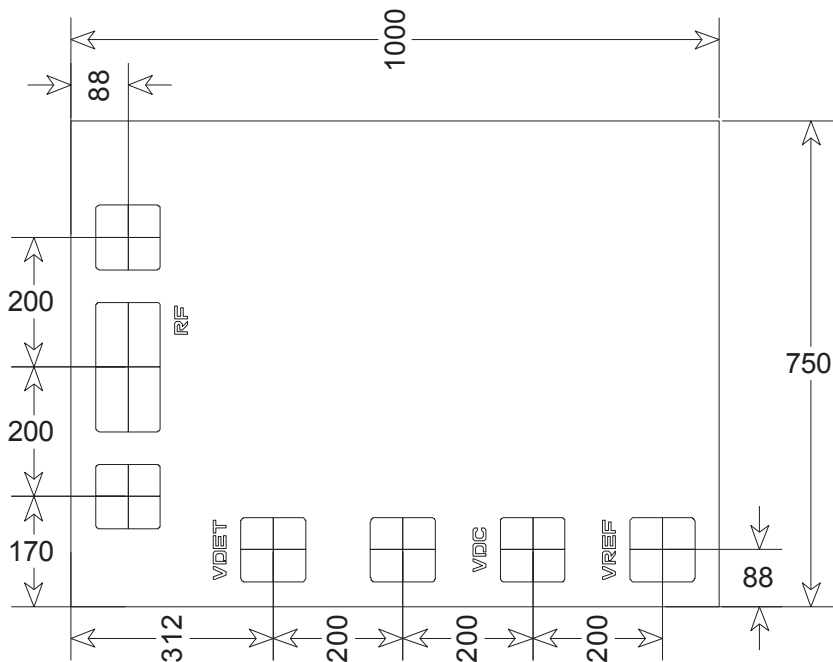

Notes:

All units are in microns, unless otherwise noted, with a tolerance of $\pm 5 \mu\text{m}$.

Die thickness is $100 \pm 10 \mu\text{m}$

RF bond-pad is $100 \times 200 \mu\text{m}$.

All other bond-pads are $100 \times 100 \mu\text{m}$.

MACOM Technology Solutions Inc. All rights reserved.

Information in this document is provided in connection with MACOM Technology Solutions Inc ("MACOM") products. These materials are provided by MACOM as a service to its customers and may be used for informational purposes only. Except as provided in MACOM's Terms and Conditions of Sale for such products or in any separate agreement related to this document, MACOM assumes no liability whatsoever. MACOM assumes no responsibility for errors or omissions in these materials. MACOM may make changes to specifications and product descriptions at any time, without notice. MACOM makes no commitment to update the information and shall have no responsibility whatsoever for conflicts or incompatibilities arising from future changes to its specifications and product descriptions. No license, express or implied, by estoppel or otherwise, to any intellectual property rights is granted by this document.

THESE MATERIALS ARE PROVIDED "AS IS" WITHOUT WARRANTY OF ANY KIND, EITHER EXPRESS OR IMPLIED, RELATING TO SALE AND/OR USE OF MACOM PRODUCTS INCLUDING LIABILITY OR WARRANTIES RELATING TO FITNESS FOR A PARTICULAR PURPOSE, CONSEQUENTIAL OR INCIDENTAL DAMAGES, MERCHANTABILITY, OR INFRINGEMENT OF ANY PATENT, COPYRIGHT OR OTHER INTELLECTUAL PROPERTY RIGHT. MACOM FURTHER DOES NOT WARRANT THE ACCURACY OR COMPLETENESS OF THE INFORMATION, TEXT, GRAPHICS OR OTHER ITEMS CONTAINED WITHIN THESE MATERIALS. MACOM SHALL NOT BE LIABLE FOR ANY SPECIAL, INDIRECT, INCIDENTAL, OR CONSEQUENTIAL DAMAGES, INCLUDING WITHOUT LIMITATION, LOST REVENUES OR LOST PROFITS, WHICH MAY RESULT FROM THE USE OF THESE MATERIALS.

MACOM products are not intended for use in medical, lifesaving or life sustaining applications. MACOM customers using or selling MACOM products for use in such applications do so at their own risk and agree to fully indemnify MACOM for any damages resulting from such improper use or sale.