

Transformer, 2:1 Flux Coupled Transformer 5MHz - 85 MHz

Rev. V3

Features

- Surface mount
- 2:1 Impedance ratio
- Centre tap on secondary
- Suitable for DOCSIS 3.0
- RoHS compliant
- Available on tape and reel

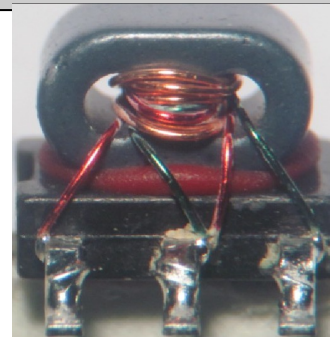

Electrical Specifications: $Z_0 = 75\Omega$, $T_A = 25^\circ\text{C}$, $P_{in} = 0\text{dBm}$

Parameter	Conditions	Units	Min	Typ	Max
Frequency Range		MHz	5		85
Impedance		Ω		75	
Impedance Ratio				2:1	
Insertion Loss (Pin1 - Pin6)	5 - 50 MHz	dB	-	0.4	0.6
	50 - 85 MHz	dB	-	0.5	0.7
Insertion Loss (Pin1 - Pin4)	5 - 50 MHz	dB	-	0.4	0.6
	50 - 85 MHz	dB	-	0.5	0.7
Amplitude Balance	5 - 50 MHz	dB	-	0.02	± 0.2
	50 - 85 MHz	dB	-	0.04	± 0.3
Phase Balance	5 - 50 MHz	$^\circ$	-	0.1	± 2.0
	50 - 85 MHz	$^\circ$	-	0.3	± 3.0
Input Return Loss (Pin1)	5 - 45 MHz	dB	20	25	-
	45 - 85 MHz	dB	15	19	-

Schematic

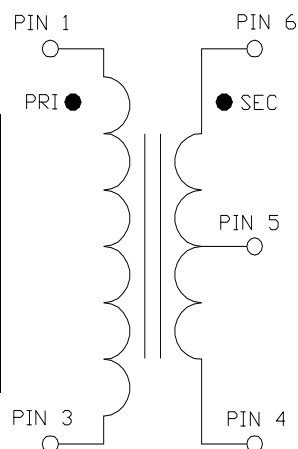

Pin Configuration

Pin No.	Function
1	Primary Dot
3	Primary
4	Secondary
5	Secondary Centre Tap
6	Secondary Dot

MABA-011017



Transformer, 2:1 Flux Coupled Transformer
5MHz - 85 MHz

Rev. V3

Electrical Specifications: $Z_0 = 75\Omega$, $T_A = 25^\circ\text{C}$, $P_{in} = 0\text{dBm}$

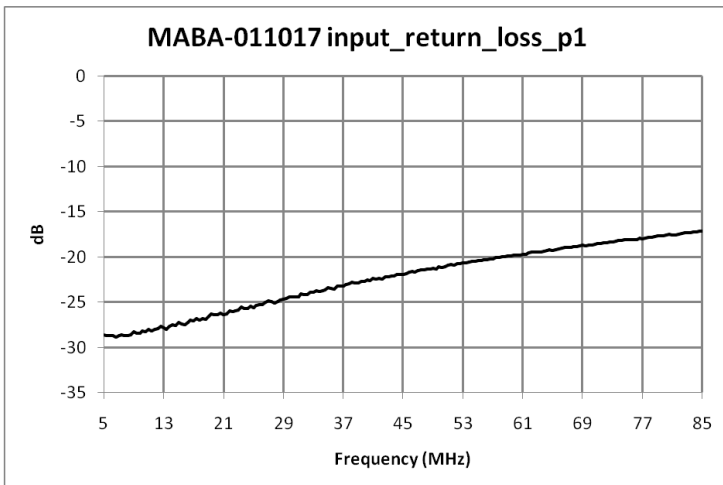
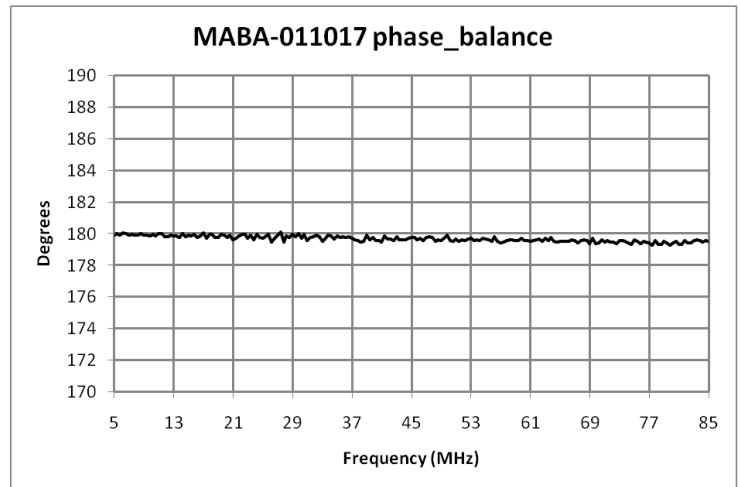
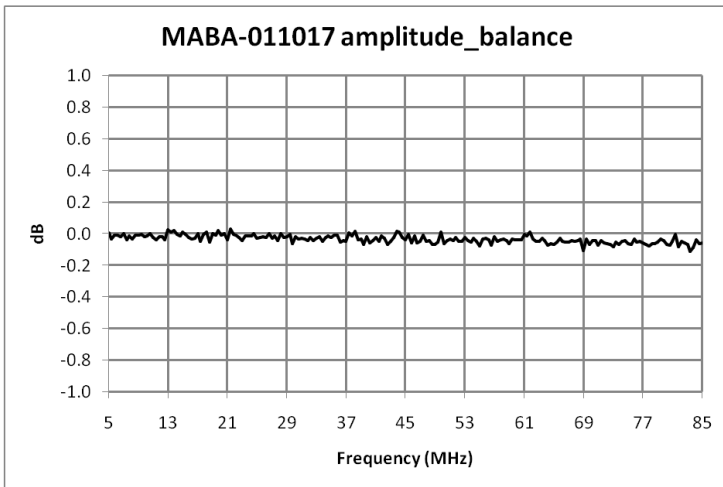
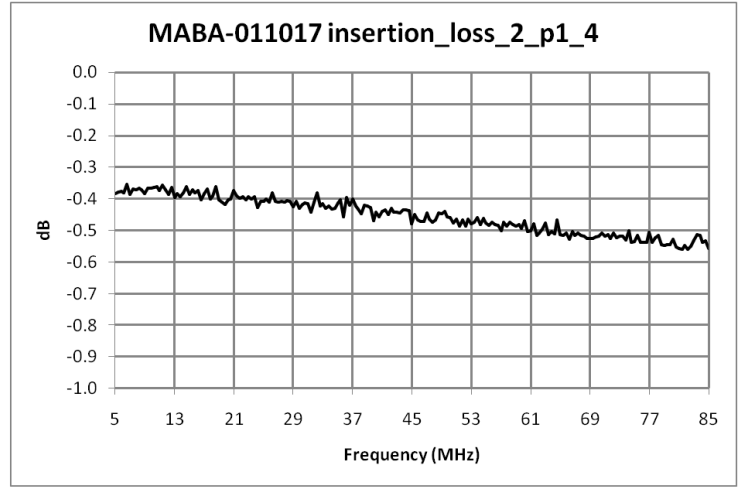
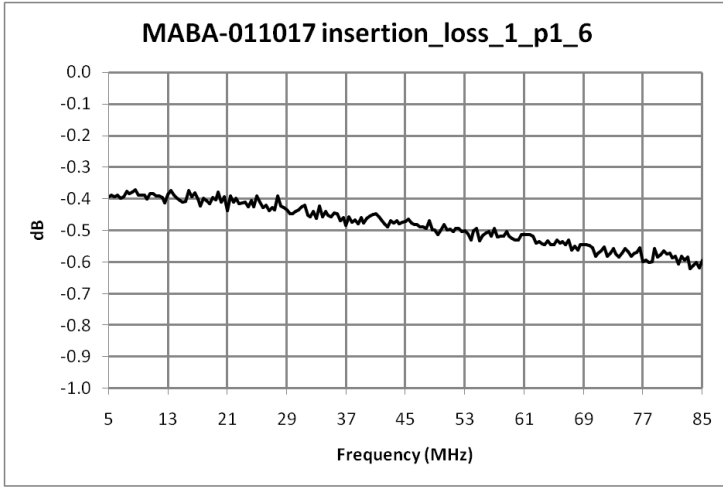

Outline Drawing

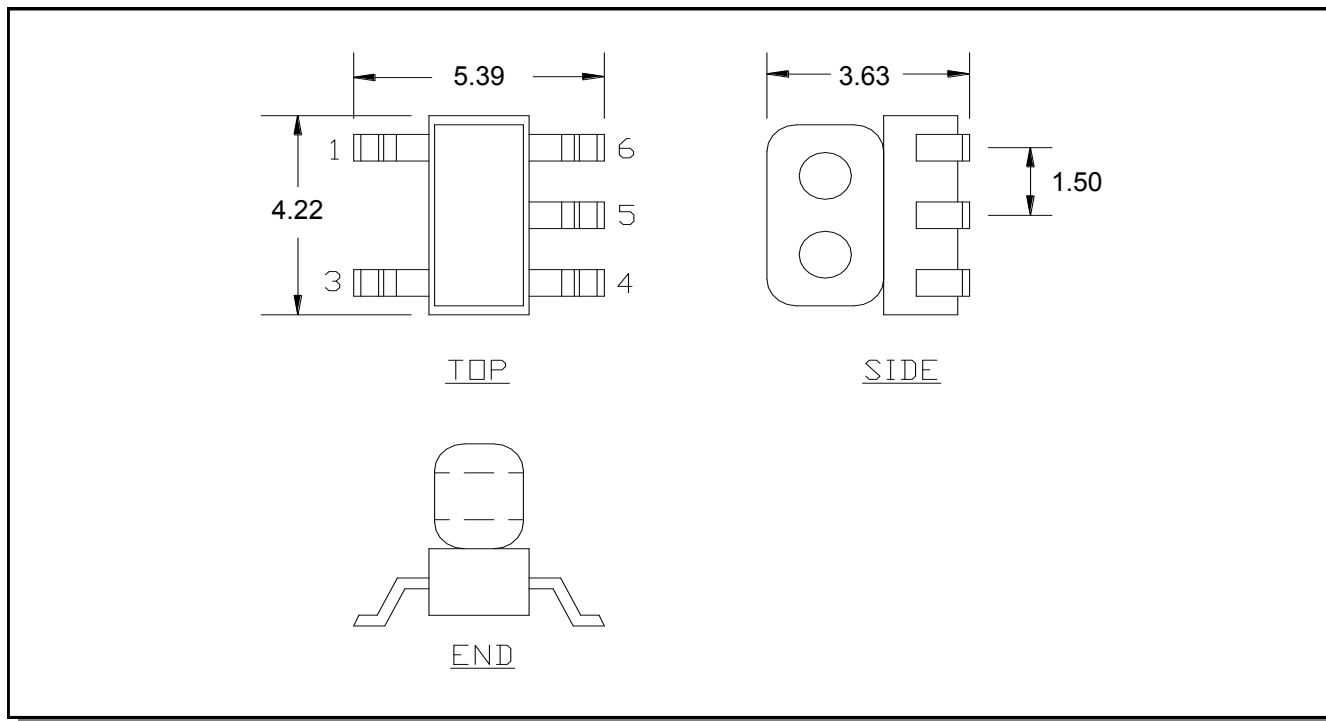

1. Dimensions in mm.
2. Tolerance: $\pm 0.2\text{mm}$ unless otherwise noted.
3. Model number and lot code printed on reel.
4. Lead plating (CuSn6) Lead finish SAC-305.

Application Circuit

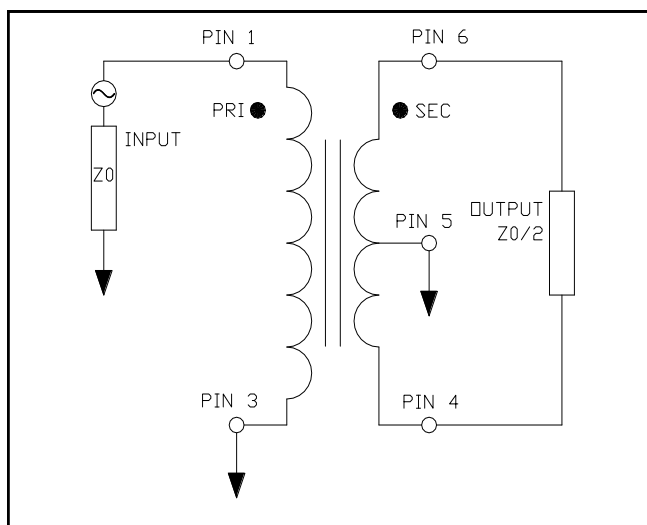

Recommended Footprint

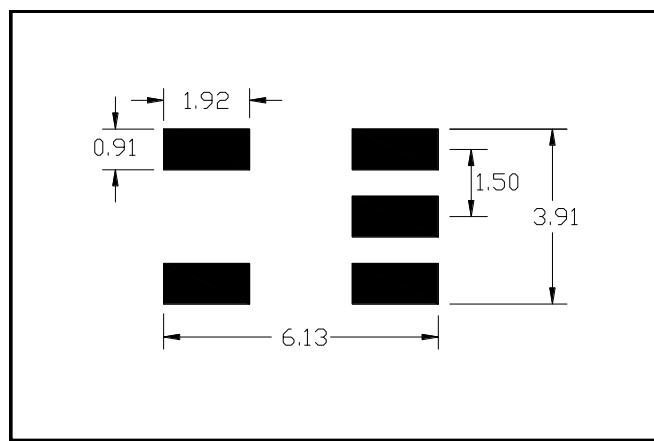

3

M/A-COM Technology Solutions Inc. (MACOM) and its affiliates reserve the right to make changes to the product(s) or information contained herein without notice. Visit www.macom.com for additional data sheets and product information.

Tape & Reel Information

Parameter	Units	Value
Qty per reel	-	2000
Reel size	mm	330
Tape width (W)	mm	12.00
Pitch (P ₁)	mm	8.00
A ₀	mm	5.6
B ₀	mm	4.5
K ₀	mm	4.0
Orientation	-	F26
Reference Application note ANI-019 for orientation		

Ordering Information

Part Number	Description
MABA-011017	Tape & Reel
MABA-011017-TB	Customer Evaluation Board

Recommended Maximum Ratings

Parameter	Value
Input Power	At least +28dBm (631mW)
DC Current (tested at 5V)	At least 600mA
Operating Temperature Range	-40°C to +85°C

Temperature data available on request