

Features

- Low Power Consumption: 5 V, 85 mA.
- 16 dB Flat Gain: 50 MHz - 2700 MHz
- Low Noise: 2.7 dB
- Power Down Control: $I_{DD} < 4$ mA
- Current Adjust
- Low Distortion Performance
- Lead-Free 2 mm PDFN-8LD Plastic Package
- Halogen-Free "Green" Mold Compound
- RoHS* Compliant

Description

The MAAM-011117 provides high gain, low noise and low distortion amplification for 75 Ω customer premises equipment (CPE).

The MAAM-011117 incorporates a power-down function to reduce the overall current consumption to less than 4 mA for standby operation.

The MAAM-011117 is packaged in a 2 mm 8-lead package and requires a minimal number of off-chip components resulting in a highly integrated low cost solution.

Ordering Information^{1,2}

Part Number	Package
MAAM-011117-TR3000	3000 piece reel
MAAM-011117-001SMB	Sample Board

1. Reference Application Note M513 for reel size information.
2. All sample boards include 5 loose parts.

Functional Schematic

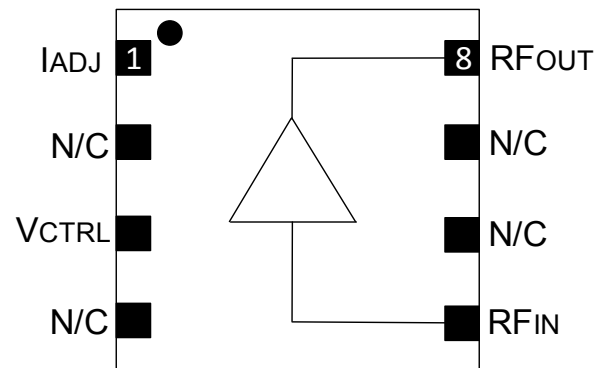

Pin Configuration³

Pin No.	Pin Name	Description
1	I_{ADJ}	Current Control
2	N/C	No Connection
3	V_{CTRL}	Power Down LO: 0 V; HI: 3.3 V
4	N/C	No Connection
5	RF_{IN}	RF Input (75 Ω)
6	N/C	No Connection
7	N/C	No Connection
8	RF_{OUT}	RF Output (75 Ω)
9	Paddle ⁴	RF and DC Ground

3. MACOM recommends connecting unused package pins to ground.
4. The exposed pad centered on the package bottom must be connected to RF and DC ground.

* Restrictions on Hazardous Substances, European Union Directive 2011/65/EU.

75 Ω , 5 V RF Amplifier 50 - 2700 MHz

Rev. V3

Electrical Specifications: $T_A = 25^\circ\text{C}$, Freq: 50 - 2700 MHz, $V_{DD} = +5$ Volts, $Z_0 = 75 \Omega$

Parameter	Test Conditions	Units	Min.	Typ.	Max.
Gain	—	dB	14.7	16	17.2
Gain Flatness	—	dB	—	± 0.5	—
Noise Figure	50 MHz - 1.2 GHz 1.2 GHz - 2.7 GHz	dB	—	2.7 3.0	—
Reverse Isolation	—	dB	—	20	—
Input Return Loss	—	dB	—	12	—
Output Return Loss	—	dB	—	16	—
Output IP2 ⁵	Swept frequency: 50 MHz - 870 GHz, IM Tone at 100 MHz	dBm	—	58	—
	Input tones at 2.5 GHz and 2.6 GHz, IM Tone at 100 MHz	dBm	—	45	—
	Input tones at 1.0 GHz and 1.1 GHz, Input Power = -15 dBm, Output tone 2.1 GHz	dBm	—	50	—
Output IP3 ⁵	Swept frequency from 50 MHz - 870 MHz	dBm	—	35	—
	Swept frequency from 870 MHz - 2 GHz			30	
	Swept frequency from 2.0 - 2.7 GHz			26	
Composite Triple Beat, CTB	79 Channels, +15 dBmV / Channel at I/P	dBc	—	-75	—
Composite Second Order, CSO	79 Channels, +15 dBmV / Channel at I/P	dBc	—	-65	—
Cross Modulation, XMOD	79 Channels, +15 dBmV / Channel at I/P	dBc	—	-65	—
Output P1dB	1 GHz	dBm	—	19.5	—
I_{DD}	Power Up: $V_{DD} = 5$ V, $V_{CTRL} = 3.3$ V Power Down: $V_{DD} = 5$ V, $V_{CTRL} = 0$ V	mA	—	85 3.5	105 —

5. Measured with two tones, 100 MHz spacing, -15 dBm input power per tone.

V_{CTRL} Logic Voltages ($V_{DD} = +5$ V)

Parameter	Units	Min	Typ	Max
V_{CTRL} Logic Low	V	-0.5	0	0.2
V_{CTRL} Logic High	V	1.2	3.3	3.47
I_{CTRL} Logic Low	mA	-0.5	—	1
I_{CTRL} Logic High	mA	-0.5	—	1

Handling Procedure - Static Sensitivity

Gallium Arsenide Integrated Circuits are sensitive to electrostatic discharge (ESD) and can be damaged by static electricity. Proper ESD control techniques should be used when handling these HBM Class 0A, CDM Class II devices.

Absolute Maximum Ratings^{6,7,8}

Parameter	Absolute Maximum
Input Power	7 dBm
Operating Voltage	10 volts
Operating Temperature	-40°C to +85°C
Storage Temperature	-65°C to +150°C

- Exceeding any one or combination of these limits may cause permanent damage to this device.
- MACOM does not recommend sustained operation near these survivability limits.
- Junction Temperature (T_J) = $T_C + \Theta_{jc} * (V * I)$
Typical thermal resistance (Θ_{jc}) = 73° CW.
a) For $T_C = +25^\circ\text{C}$,
 $T_J = 57^\circ\text{C}$ @ 5 V, 85 mA
b) For $T_C = +85^\circ\text{C}$,
 $T_J = 117^\circ\text{C}$ @ 5 V, 85 mA

Recommended Board Layout

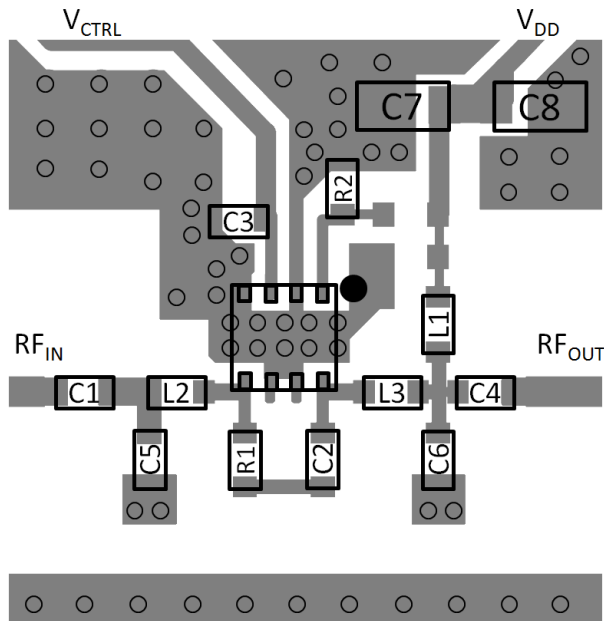

Schematic Including Off-Chip Components

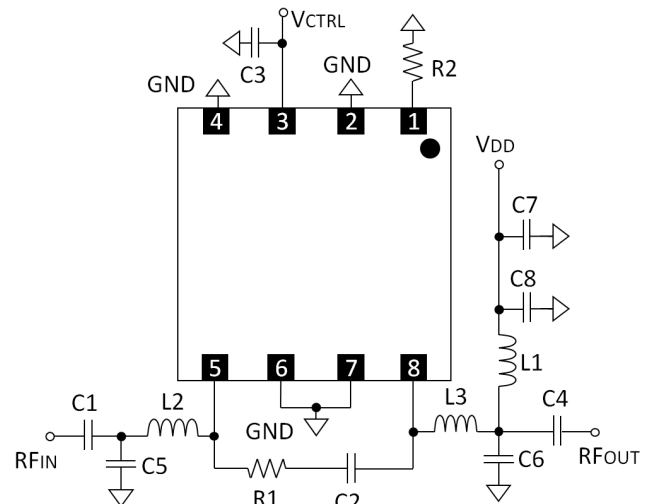

PCB Land Pattern

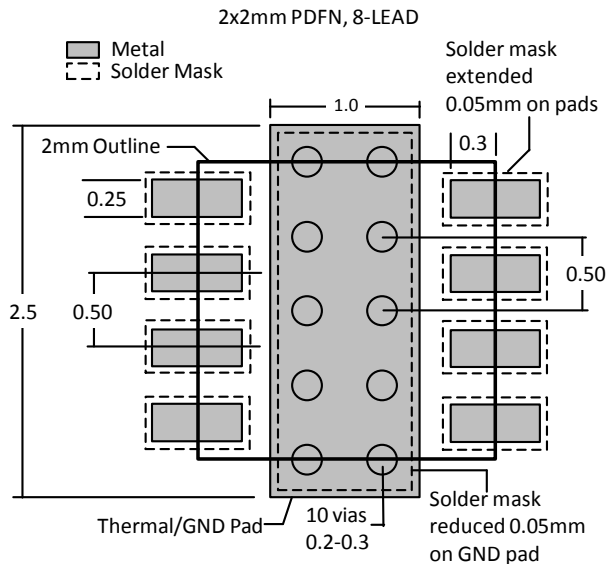

Parts List⁹

Component	Value	Package
C1 - C3	10 nF	0402
C4	220 pF	0402
C5	0.7 pF	0402
C6	0.2 pF	0402
C7	100 nF	0603
C8	1 μ F	0603
R1	510 Ω	0402
R2	510 k Ω	0402
L1	Ferrite Bead	0402
L2	3.0 nH	0402
L3	3.3 nH	0402

9. Ferrite Bead from Murata, part number BLM15HD182SN.

Typical Performance Curves: $V_{DD} = +5\text{ V}$; $I_{DD} = 85\text{ mA}$, Power-Up Mode

Gain to 2.7 GHz

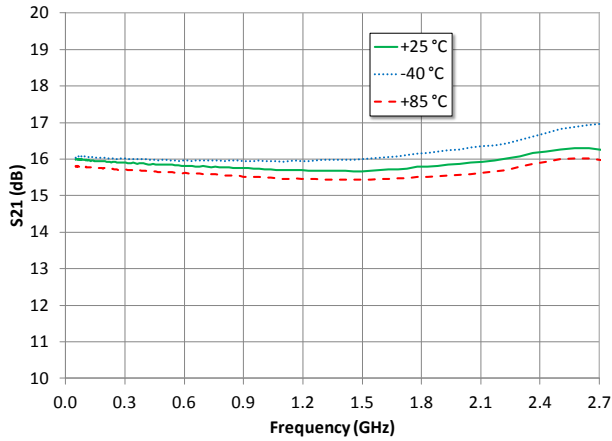

Gain to 5 GHz

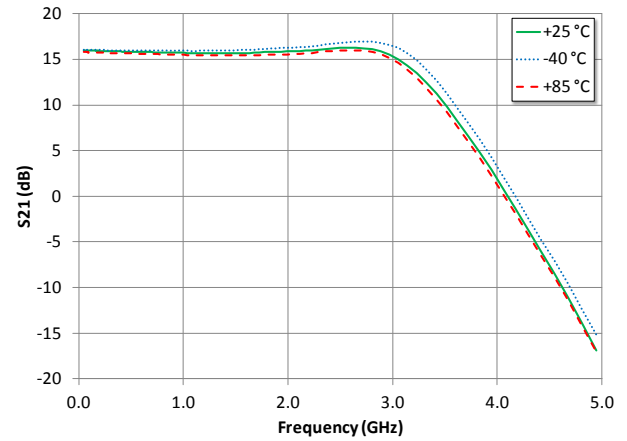

Input Return Loss

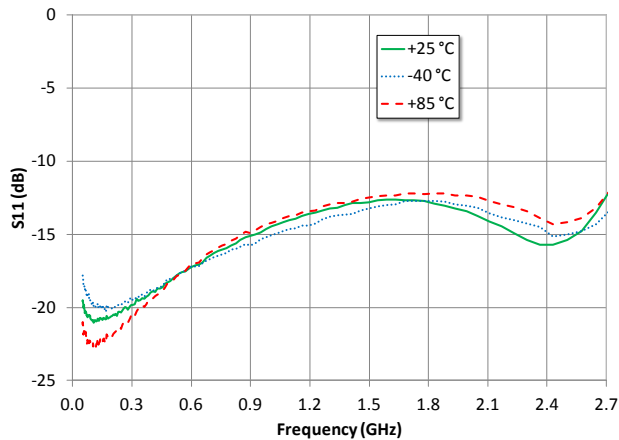

Output Return Loss

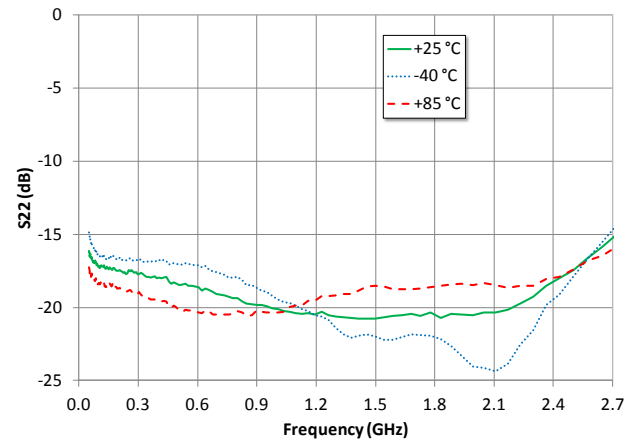

Noise Figure

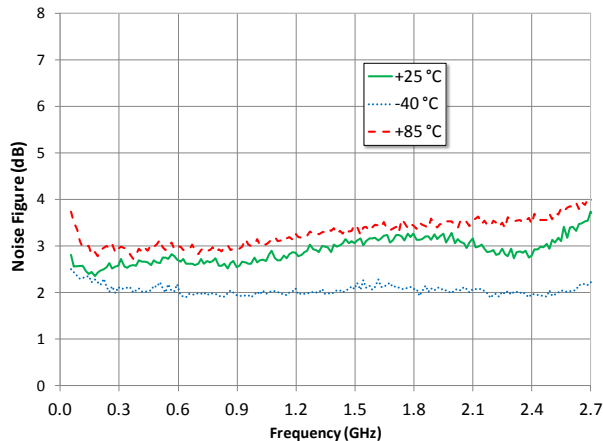

Reverse Isolation

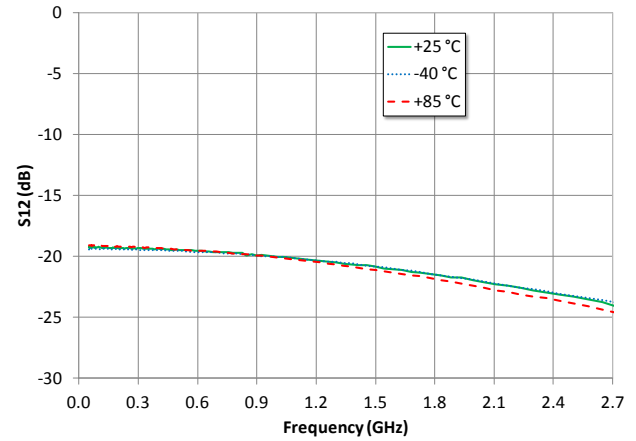

Typical Performance Curves: $V_{DD} = +5 V$; $I_{DD} = 85 mA$, Power-Up Mode

CSO Lower

79ch, +15 dBmV/ch Flat Input Power

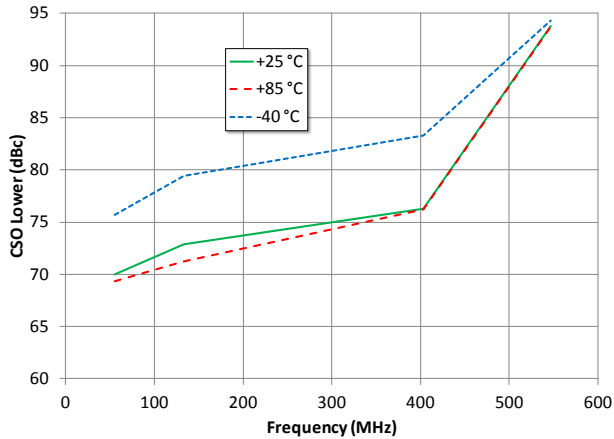

CSO Upper

79ch, +15 dBmV/ch Flat Input Power

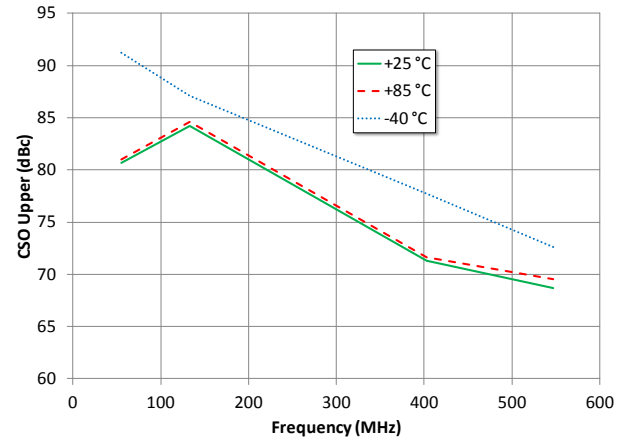

CTB

79ch, +15 dBmV/ch Flat Input Power

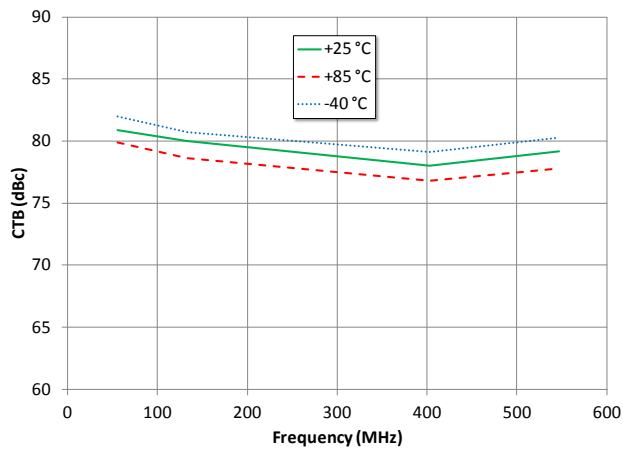

Cross Modulation

79ch, +15 dBmV/ch Flat Input Power

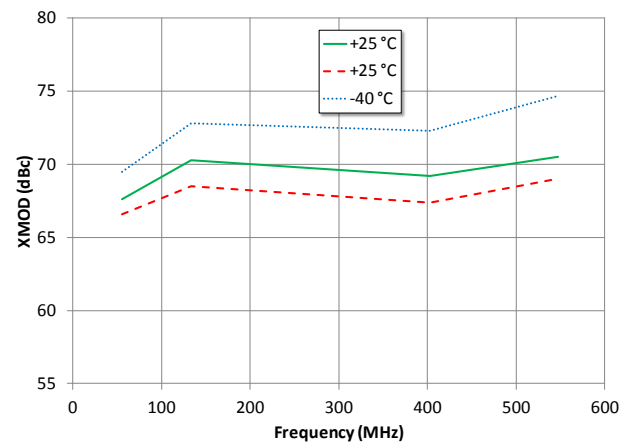

Lead Free 2 mm 8-lead PDFN†

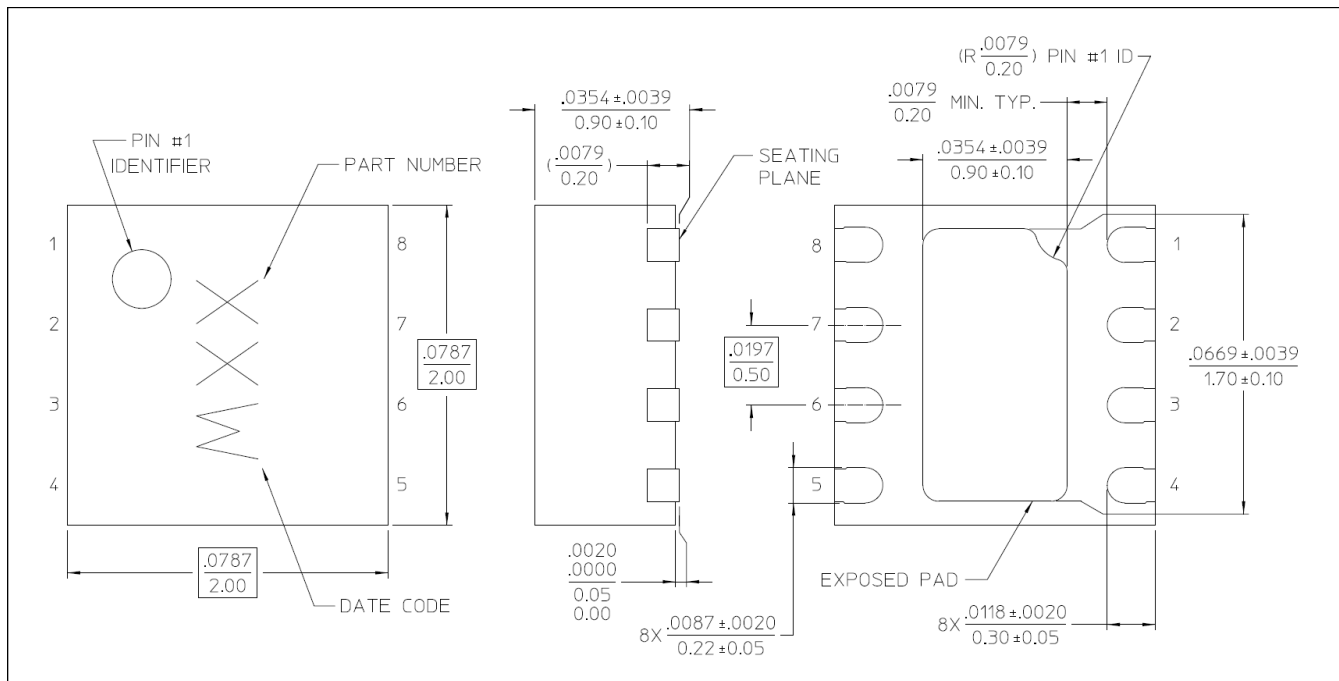

† Reference Application Note M538 for lead-free solder reflow recommendations.
 Meets JEDEC moisture sensitivity level 1 requirements.
 Plating is 100% matte tin over copper.
 Reference JEDEC MO-229 for additional dimensional and tolerance information
 All dimensions shown as in/mm

M/A-COM Technology Solutions Inc. All rights reserved.

Information in this document is provided in connection with M/A-COM Technology Solutions Inc ("MACOM") products. These materials are provided by MACOM as a service to its customers and may be used for informational purposes only. Except as provided in MACOM's Terms and Conditions of Sale for such products or in any separate agreement related to this document, MACOM assumes no liability whatsoever. MACOM assumes no responsibility for errors or omissions in these materials. MACOM may make changes to specifications and product descriptions at any time, without notice. MACOM makes no commitment to update the information and shall have no responsibility whatsoever for conflicts or incompatibilities arising from future changes to its specifications and product descriptions. No license, express or implied, by estoppel or otherwise, to any intellectual property rights is granted by this document.

THESE MATERIALS ARE PROVIDED "AS IS" WITHOUT WARRANTY OF ANY KIND, EITHER EXPRESS OR IMPLIED, RELATING TO SALE AND/OR USE OF MACOM PRODUCTS INCLUDING LIABILITY OR WARRANTIES RELATING TO FITNESS FOR A PARTICULAR PURPOSE, CONSEQUENTIAL OR INCIDENTAL DAMAGES, MERCHANTABILITY, OR INFRINGEMENT OF ANY PATENT, COPYRIGHT OR OTHER INTELLECTUAL PROPERTY RIGHT. MACOM FURTHER DOES NOT WARRANT THE ACCURACY OR COMPLETENESS OF THE INFORMATION, TEXT, GRAPHICS OR OTHER ITEMS CONTAINED WITHIN THESE MATERIALS. MACOM SHALL NOT BE LIABLE FOR ANY SPECIAL, INDIRECT, INCIDENTAL, OR CONSEQUENTIAL DAMAGES, INCLUDING WITHOUT LIMITATION, LOST REVENUES OR LOST PROFITS, WHICH MAY RESULT FROM THE USE OF THESE MATERIALS.

MACOM products are not intended for use in medical, lifesaving or life sustaining applications. MACOM customers using or selling MACOM products for use in such applications do so at their own risk and agree to fully indemnify MACOM for any damages resulting from such improper use or sale.