

Features

- Attenuation: 1.0 dB Steps to 31 dB
- High Accuracy to 6 GHz
- Small Footprint, JEDEC Package
- Integral TTL driver
- 50 ohm impedance
- Test boards are available
- Tape and Reel Packaging Available
- Lead-Free CSP-1 Package
- 100% Matte Tin Plating over Copper
- Halogen-Free “Green” Mold Compound
- 260°C Reflow Compatible
- RoHS* Compliant Version of AT90-0001

Description

M/A-COM's MAAD-007083-000100 is a GaAs FET 5-bit digital attenuator with an integral TTL driver. Step size is 1.0 dB providing 31 dB total attenuation range. This device is in a 32 lead FQFP-N surface mount package. Due to superior grounding techniques this digital attenuator offers superior performance to 6 GHz. The MAAD-007083-000100 is ideally suited for use where accuracy, fast speed, very low power consumption and low costs are required.

Ordering Information

Part Number	Package
MAAD-007083-000100	Bulk Packaging
MAAD-007083-0001TR	1000 piece reel
MAAD-007083-0001TB	Sample Test Board

Note: Reference Application Note M513 for reel size information.

* Restrictions on Hazardous Substances, European Union Directive 2002/95/EC.

Functional Schematic

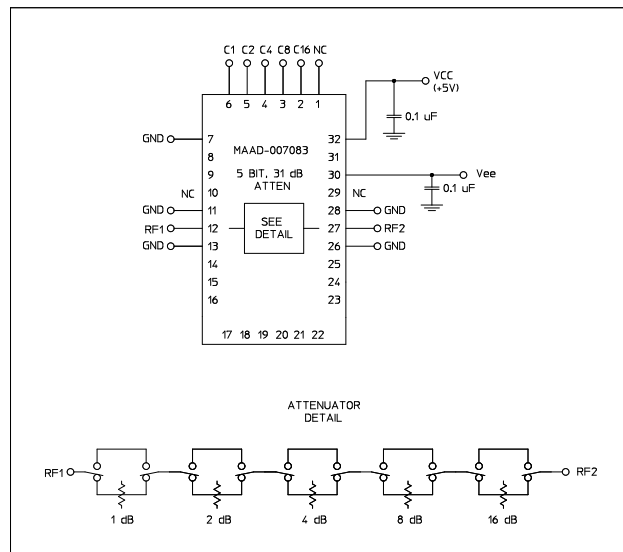

Pin Configuration¹

Pin No.	Function	Pin No.	Function
1	NC	17	NC
2	C16	18	NC
3	C8	19	NC
4	C4	20	NC
5	C2	21	NC
6	C1	22	NC
7	GND	23	NC
8	NC	24	NC
9	NC	25	NC
10	NC ²	26	GND
11	GND	27	RF2
12	RF1	28	GND
13	GND	29	NC ²
14	NC	30	-Vee
15	NC	31	NC
16	NC	32	+Vcc

1. The exposed pad centered on the package bottom must be connected to RF and DC ground. (For PQFN Packages)
2. Pins 10 and 29 must be isolated.

Digital Attenuator, 31.0 dB, 5-Bit, TTL Driver, DC - 6.0 GHz

Rev. V5

Electrical Specifications: $T_A = 25^\circ\text{C}$, $Z_0 = 50\Omega$, $V_{cc} = 5.0\text{V}$, $V_{ee} = -5.0\text{V}$

Parameter	Test Conditions	Frequency	Units	Min	Typ	Max
Insertion Loss	—	DC - 2.0 GHz	dB	—	2.5	3.1
		DC - 4.0 GHz	dB	—	3.3	3.8
		DC - 6.0 GHz	dB	—	5.0	5.8
Attenuation Accuracy	1 to 24 dB Bits	DC - 6.0 GHz	dB	—	—	$\pm(0.3 + 4\% \text{ of atten.})$
	25 to 31 dB Bits	DC - 6.0 GHz	dB	—	—	$\pm(0.3 + 5\% \text{ of atten.})$
VSWR	Full Range	DC - 2.0 GHz	Ratio	—	1.4:1	1.7:1
		DC - 6.0 GHz	Ratio	—	1.7:1	2.4:1
1 dB Compression	—	50 MHz	dBm	—	+22	—
		0.5 - 6.0 GHz	dBm	—	+24	—
Input IP2	Two tone inputs to +5 dBm	50 MHz	dBm	—	+43	—
		0.5 - 6.0 GHz	dBm	—	+60	—
Input IP3	Two-tone inputs up to +5 dBm	50 MHz	dB	—	+37	—
		0.5-6.0 GHz	dB	—	+48	—
V _{cc}	—	—	V	4.75	5.0	5.25
V _{ee}	—	—	V	-8.0	-5.0	-4.75
Switching Speed	50% Cntl to 90%/10% RF 10% to 90% or 90% to 10%	—	ns	—	25	—
		—	ns	—	15	—
V _{IL}	LOW-level input voltage	—	V	0.0	-	0.8
V _{IH}	HIGH-level input voltage	—	V	2.0	-	5.0
I _{in} (Input Leakage Current)	V _{in} = V _{cc} or GND	—	uA	-1.0	-	1.0
I _{cc} (Quiescent Supply Current)	V _{cntrl} = V _{cc} or GND	—	uA	—	250	400
ΔI_{cc}^3 (Additional Supply Current Per TTL Input Pin)	V _{cc} = Max, V _{cntrl} = V _{cc} - 2.1V	—	mA	—	—	1.0
I _{ee}	V _{ee} min to max, V _{in} = V _{IL} or V _{IH}	—	mA	-1.0	-0.2	-
Thermal Resistance θ_{jc}	—	—	$^\circ\text{C/W}$	—	15	—

3. The 16 dB bit is connected to two driver input pins, so ΔI_{cc} needs to be calculated based on 6 TTL inputs.

Absolute Maximum Ratings^{4,5}

Parameter	Absolute Maximum
Input Power 0.05 GHz 0.5 - 6.0 GHz	+27 dBm +34 dBm
V _{cc}	$-0.5\text{V} \leq V_{cc} \leq +7.0\text{V}$
V _{ee}	$-8.5\text{V} \leq V_{ee} \leq +0.5\text{V}$
V _{cc} - V _{ee}	$-0.5\text{V} \leq V_{cc} - V_{ee} \leq 14.5\text{V}$
V _{in} ⁶	$-0.5\text{V} \leq V_{in} \leq V_{cc} + 0.5\text{V}$
Operating Temperature	-40°C to $+85^\circ\text{C}$
Storage Temperature	-65°C to $+125^\circ\text{C}$

4. Exceeding any one or combination of these limits may cause permanent damage to this device.
 5. MACOM does not recommend sustained operation near these survivability limits.
 6. Standard CMOS TTL interface, latch-up will occur if logic signal is applied prior to power supply.

Truth Table (Digital Attenuator)

C16	C8	C4	C2	C1	Attenuation
0	0	0	0	0	Loss, Reference
0	0	0	0	1	1 dB
0	0	0	1	0	2 dB
0	0	1	0	0	4 dB
0	1	0	0	0	8 dB
1	0	0	0	0	16 dB
1	1	1	1	1	31 dB

0 = TTL Low; 1 = TTL High

2

Handling Procedures

Please observe the following precautions to avoid damage:

Static Sensitivity

Gallium Arsenide Integrated Circuits are sensitive to electrostatic discharge (ESD) and can be damaged by static electricity. Proper ESD control techniques should be used when handling these devices.

Moisture Sensitivity

The MSL rating for this part is defined as Level 2 per IPC/JEDEC J-STD-020. Parts shall be stored and/or baked as required for MSL Level 2 parts.

Recommended PCB Configuration⁷

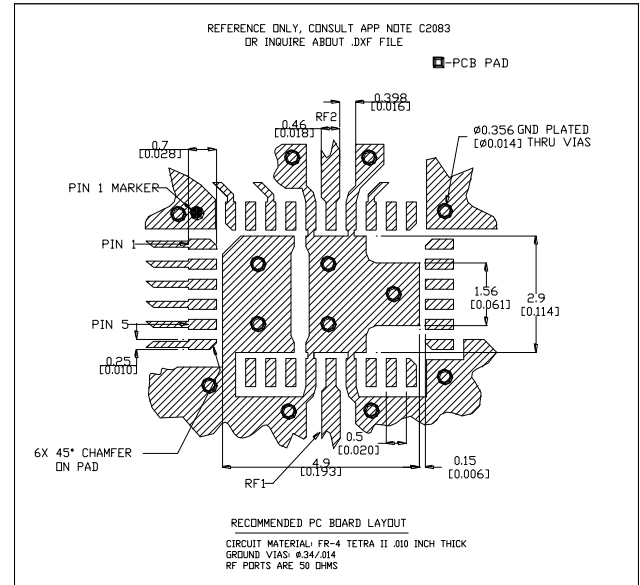

7. Application Note S2083 is available at www.macom.com

Typical Performance Curves

Insertion Loss vs. Frequency

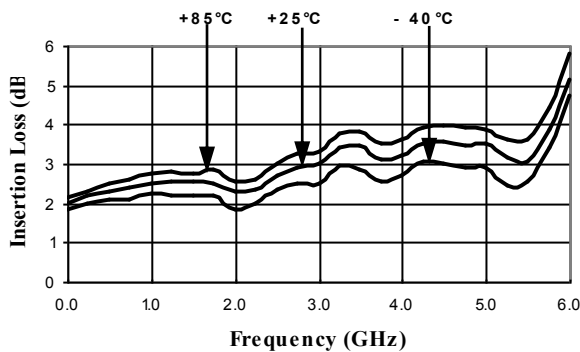

VSWR vs. Frequency

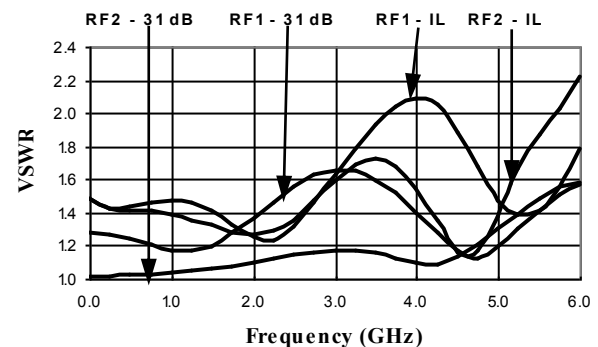

Accuracy (dB) vs. Frequency

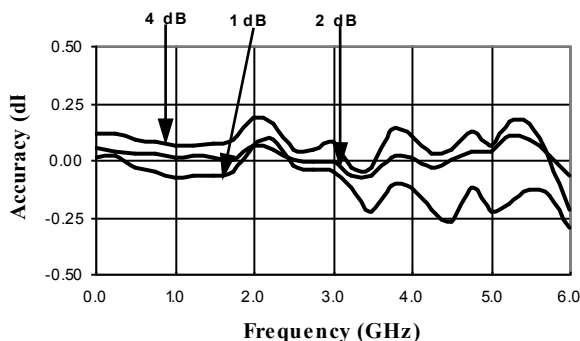

Accuracy (dB) vs. Frequency

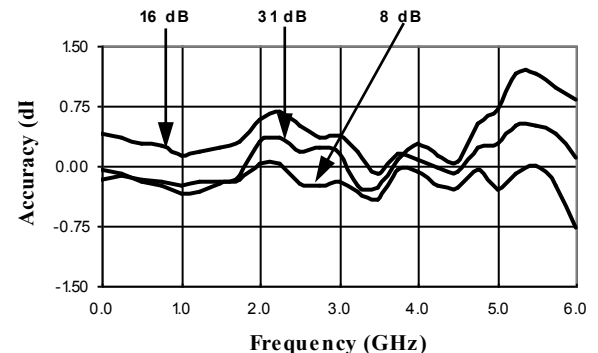

**Digital Attenuator,
31.0 dB, 5-Bit, TTL Driver, DC - 6.0 GHz**

Rev. V5

CSP-1, Lead-Free 4 x 6 mm, 32-lead PQFN[†]

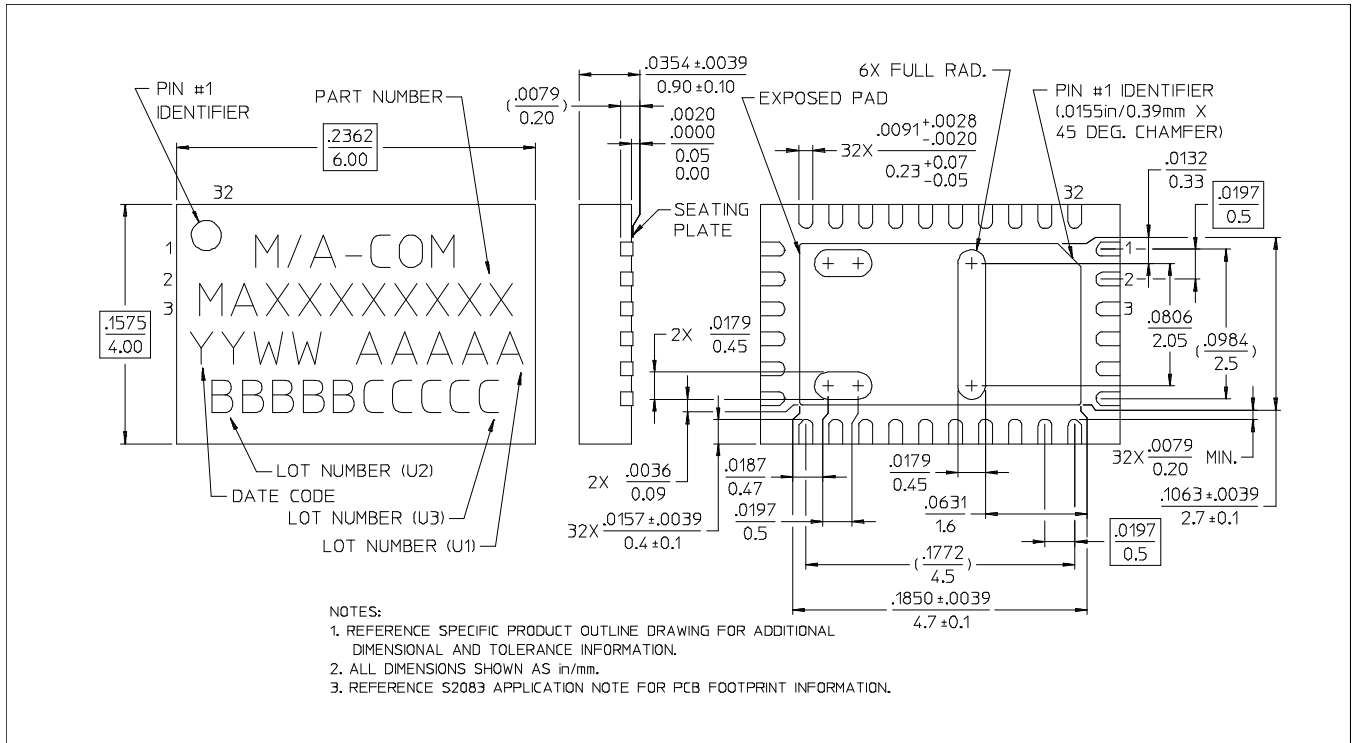

[†] Reference Application Note M538 for lead-free solder reflow recommendations.

M/A-COM Technology Solutions Inc. All rights reserved.

Information in this document is provided in connection with M/A-COM Technology Solutions Inc ("MACOM") products. These materials are provided by MACOM as a service to its customers and may be used for informational purposes only. Except as provided in MACOM's Terms and Conditions of Sale for such products or in any separate agreement related to this document, MACOM assumes no liability whatsoever. MACOM assumes no responsibility for errors or omissions in these materials. MACOM may make changes to specifications and product descriptions at any time, without notice. MACOM makes no commitment to update the information and shall have no responsibility whatsoever for conflicts or incompatibilities arising from future changes to its specifications and product descriptions. No license, express or implied, by estoppel or otherwise, to any intellectual property rights is granted by this document.

THESE MATERIALS ARE PROVIDED "AS IS" WITHOUT WARRANTY OF ANY KIND, EITHER EXPRESS OR IMPLIED, RELATING TO SALE AND/OR USE OF MACOM PRODUCTS INCLUDING LIABILITY OR WARRANTIES RELATING TO FITNESS FOR A PARTICULAR PURPOSE, CONSEQUENTIAL OR INCIDENTAL DAMAGES, MERCHANTABILITY, OR INFRINGEMENT OF ANY PATENT, COPYRIGHT OR OTHER INTELLECTUAL PROPERTY RIGHT. MACOM FURTHER DOES NOT WARRANT THE ACCURACY OR COMPLETENESS OF THE INFORMATION, TEXT, GRAPHICS OR OTHER ITEMS CONTAINED WITHIN THESE MATERIALS. MACOM SHALL NOT BE LIABLE FOR ANY SPECIAL, INDIRECT, INCIDENTAL, OR CONSEQUENTIAL DAMAGES, INCLUDING WITHOUT LIMITATION, LOST REVENUES OR LOST PROFITS, WHICH MAY RESULT FROM THE USE OF THESE MATERIALS.

MACOM products are not intended for use in medical, lifesaving or life sustaining applications. MACOM customers using or selling MACOM products for use in such applications do so at their own risk and agree to fully indemnify MACOM for any damages resulting from such improper use or sale.