

Features

- 20 dB Gain
- 11 dBm P1dB
- Single Bias
- 5 - 7 V, 90 mA Self Bias
- Lead-Free 3 mm, 16-lead QFN
- On-Chip ESD Protection
- RoHS* Compliant

Description

The CMM0511-QT is a 3 stage 5 to 14 GHz driver amplifier packaged in surface mount 3 mm 16-lead QFN package. The device is a self-biased, single bias design with 20 dB gain and 11 dBm P1dB. This MMIC uses an optical pHEMT process.

Block Diagram

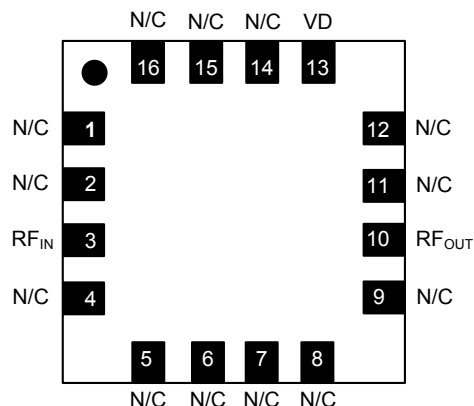

Ordering Information¹

Part Number	Package
CMM0511-QT-0G0T	500 piece reel
CMM0511-QT-0G00	Bulk
PB-CMM0511-QT-0000	Sample Board

1. Reference Application Note M513 for reel size information.

Pin Configuration²

Pin #	Function	Description
1,2,4 - 9,11, 12,14,15,16	N/C	No Connection
3	RF _{IN}	RF Input
10	RF _{OUT}	RF Output
13	VD	Drain Voltage
17 ³	GND	Paddle

2. MACOM recommends connecting No Connection (N/C) package pins to ground.
3. The exposed pad centered on the package bottom must be connected to RF, DC and thermal ground.

Electrical Specifications: Freq. = 5 - 14 GHz, T_A = +25°C, Z₀ = 50 Ω

Parameter	Units	Min.	Typ.	Max.
Gain	dB	—	20	—
Input Return Loss	dB	—	12	—
Output P1dB	dBm	—	11	—
Output IP3	dBm	—	22	—
Bias Voltage	V	—	5	7
Current	mA	—	90	120

* Restrictions on Hazardous Substances, compliant to current RoHS EU directive.

Typical Parameters: 6 V, 90 mA

Parameter	Units	Frequency (GHz)					
		5	7	9	11	13	14
Gain	dB	20.5	20.5	18.5	18.5	18.5	20.0
Input Return Loss	dB	15.0	15.0	17.0	20.0	10.0	8.0
Output Return Loss	dB	14.5	15.0	11.0	11.0	9.0	9.0
Output P1dB	dBm	13.0	13.0	10.0	10.0	10.0	11.5
Output IP3	dBm	24.0	24.0	22.0	20.0	21.0	20.5

Absolute Maximum Ratings^{4,5}

Parameter	Absolute Maximum
Input Power	10 dBm
Bias Voltage	8 V
Junction Temperature	+175°C
Operating Temperature	-40°C to +85°C
Storage Temperature	-55°C to +125°C

- Exceeding any one or combination of these limits may cause permanent damage to this device.
- MACOM does not recommend sustained operation near these survivability limits.

Handling Procedures

Please observe the following precautions to avoid damage:

Static Sensitivity

These electronic devices are sensitive to electrostatic discharge (ESD) and can be damaged by static electricity. Proper ESD control techniques should be used when handling these devices.

Evaluation Board Layout

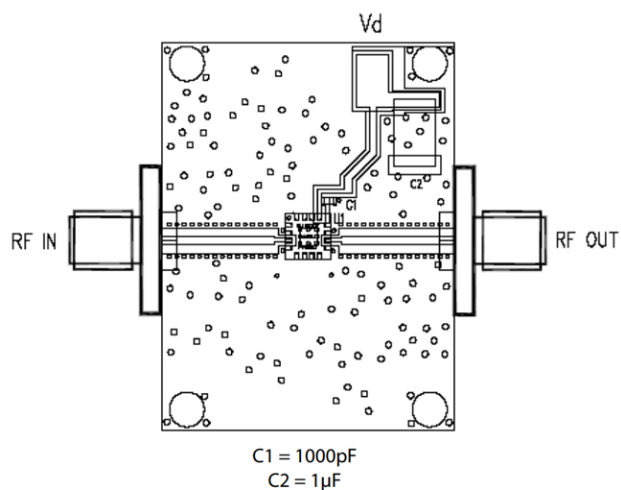

Evaluation Board Schematic

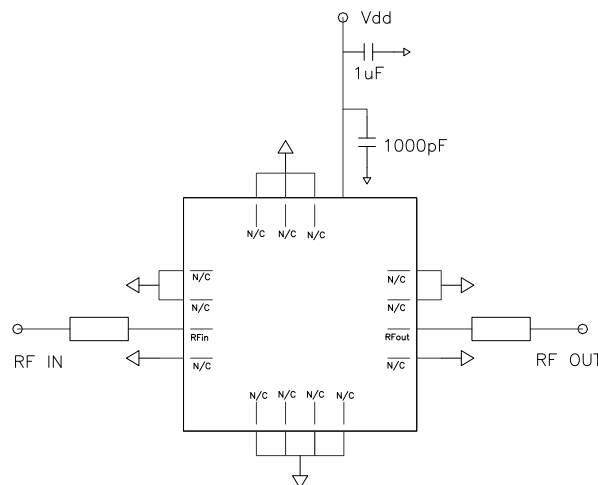

Typical Performance Curves

S-Parameters @ 6 V, 102 mA

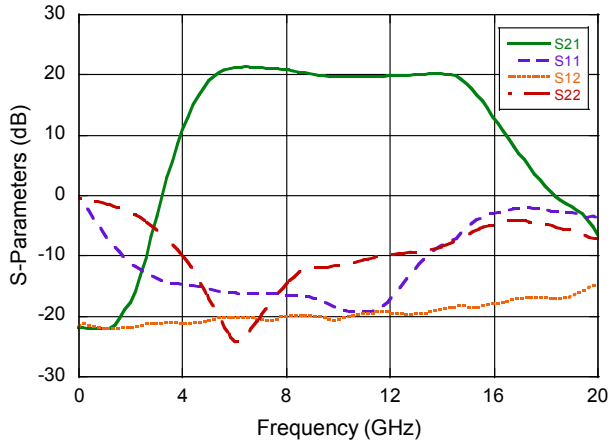

Gain vs. Frequency

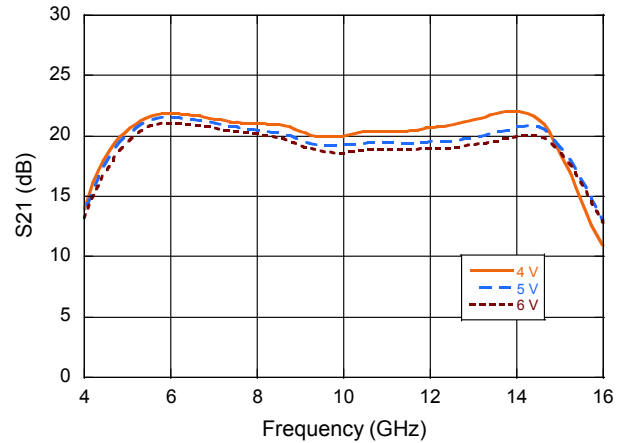

Input Return Loss vs. Frequency

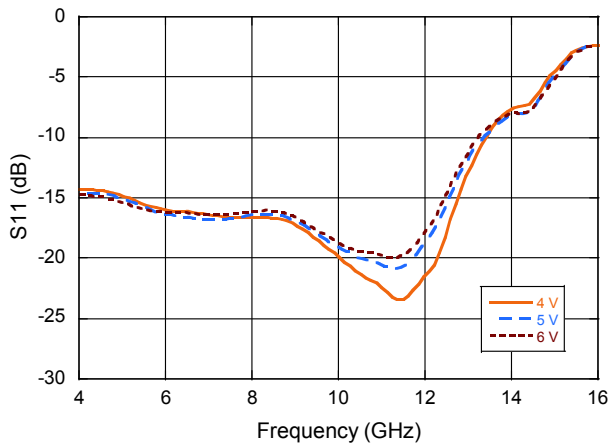

Output Return Loss vs. Frequency

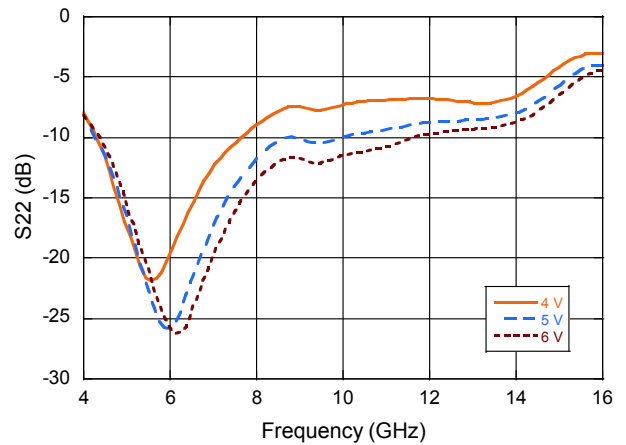

Output Power Vs. Input Power

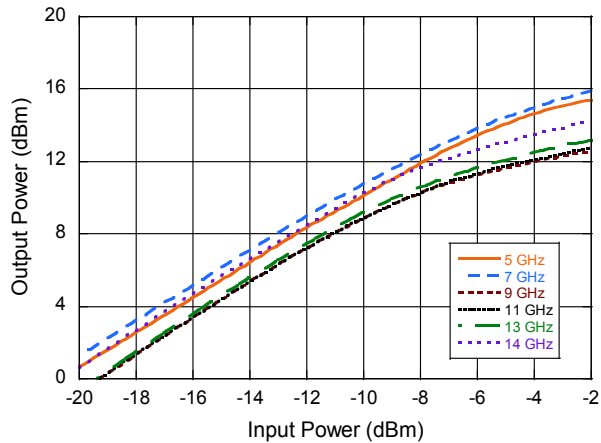

Saturated Output Power vs. Frequency @ 5 V, 90 mA

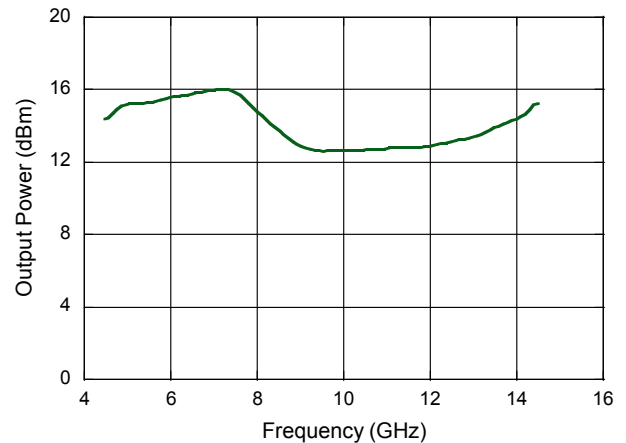

Typical Performance Curves over Temperature

Gain vs. Frequency @ 5 V, 90 mA

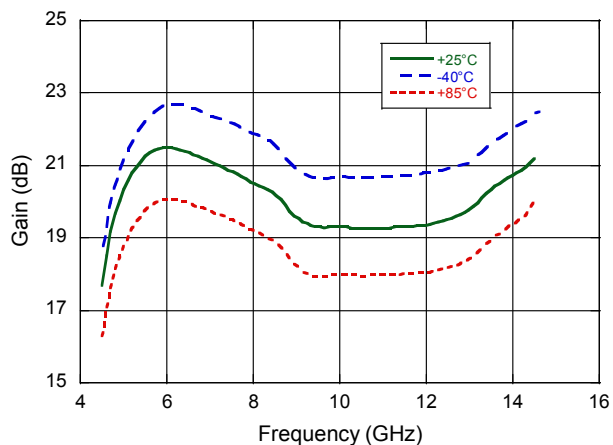

Gain vs. Frequency @ 6 V, 90 mA

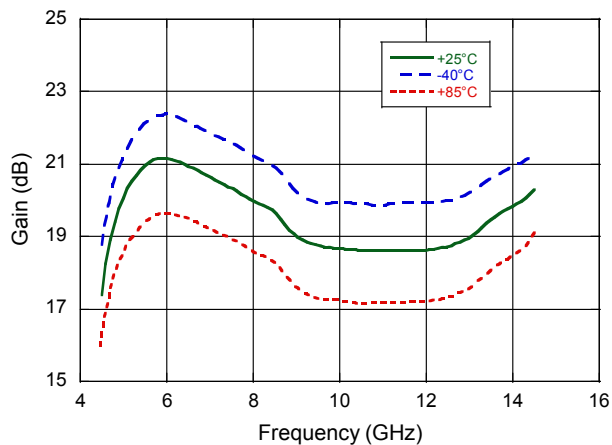

P1dB vs. Frequency @ 5 V, 90 mA

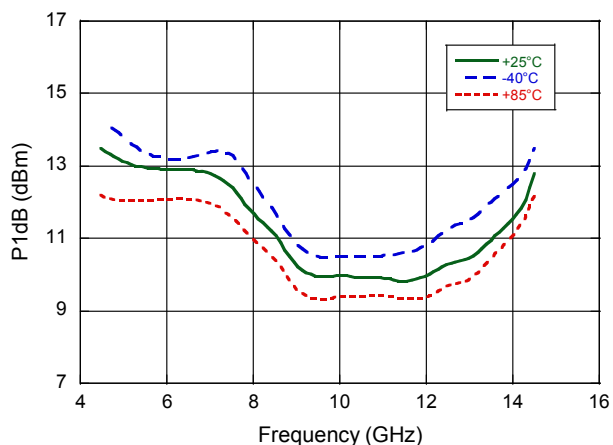

P1dB vs. Frequency @ 6 V, 90 mA

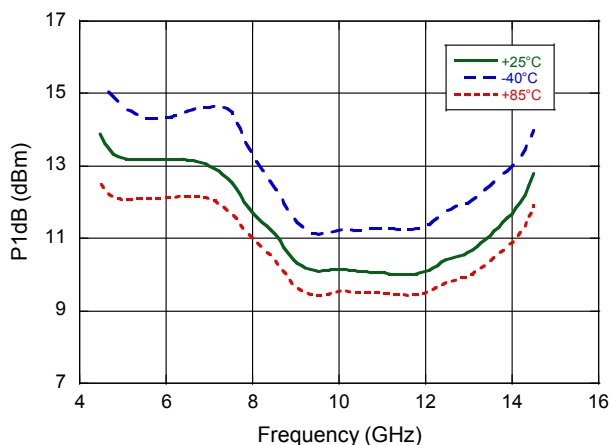

OIP3 vs. Frequency @ 5 V, 90 mA

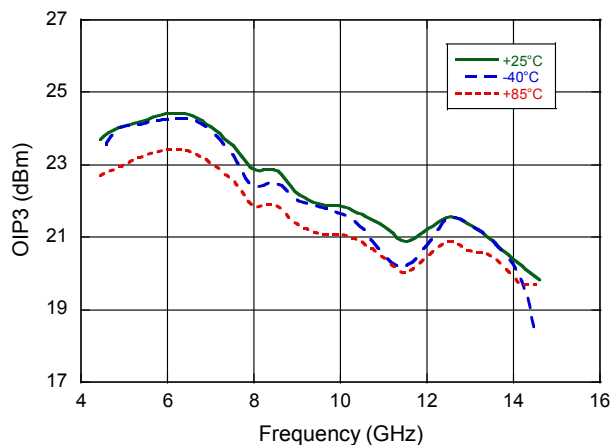

OIP3 vs. Frequency @ 6 V, 90 mA

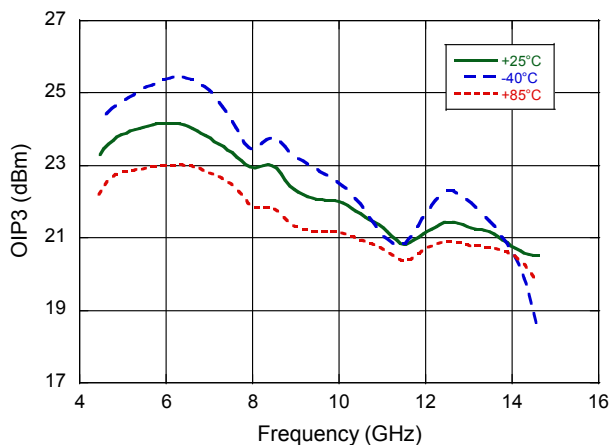

CMM0511-QT



Driver Amplifier, GaAs MMIC
5 - 14 GHz

Rev. V1

QT (3x3 mm)

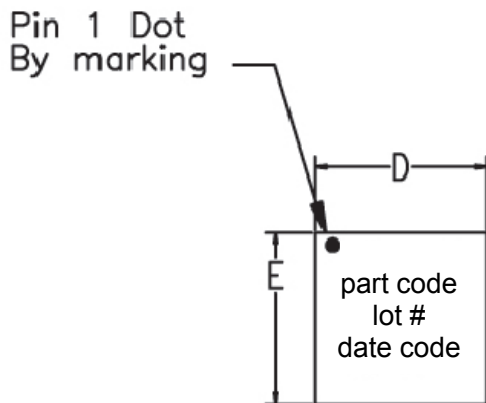

TOP VIEW

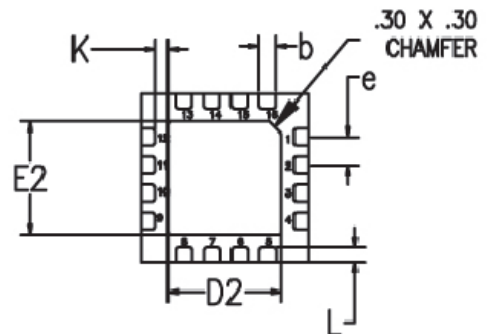
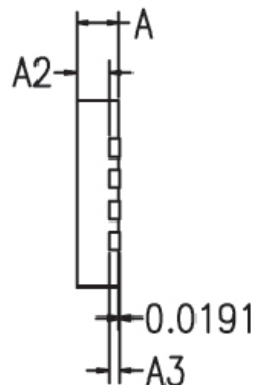

BOTTOM VIEW

ALL DIMENSIONS ARE IN mm.

RECOMMENDED SOLDER PAD PITCH AND DIMENSIONS

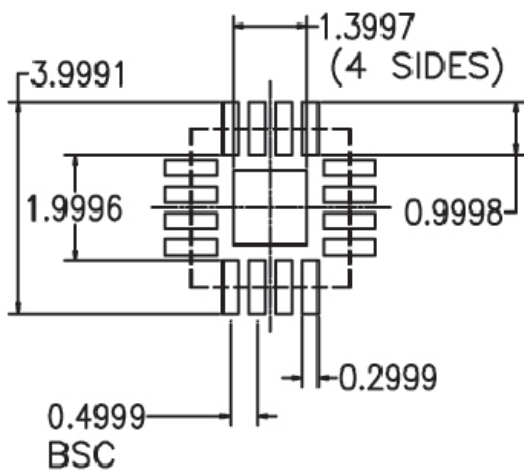

	MIN	TYP	MAX
A	0.80	0.90	1.00
A3	0.20 REF		
A2	0.00	0.65	1.00
b	0.20	0.25	0.30
K	0.20	—	—
D	3.00 BSC		
E	300 BSC		
e	0.50		
D2	1.50	1.65	1.80
E2	1.50	1.65	1.80
L	0.16	0.26	0.36

VIEWS ARE NOT TO SCALE: USE DIMENSIONS AND TABLE.

Plating is 100% matte tin over copper.

MACOM Technology Solutions Inc. All rights reserved.

Information in this document is provided in connection with MACOM Technology Solutions Inc ("MACOM") products. These materials are provided by MACOM as a service to its customers and may be used for informational purposes only. Except as provided in MACOM's Terms and Conditions of Sale for such products or in any separate agreement related to this document, MACOM assumes no liability whatsoever. MACOM assumes no responsibility for errors or omissions in these materials. MACOM may make changes to specifications and product descriptions at any time, without notice. MACOM makes no commitment to update the information and shall have no responsibility whatsoever for conflicts or incompatibilities arising from future changes to its specifications and product descriptions. No license, express or implied, by estoppel or otherwise, to any intellectual property rights is granted by this document.

THESE MATERIALS ARE PROVIDED "AS IS" WITHOUT WARRANTY OF ANY KIND, EITHER EXPRESS OR IMPLIED, RELATING TO SALE AND/OR USE OF MACOM PRODUCTS INCLUDING LIABILITY OR WARRANTIES RELATING TO FITNESS FOR A PARTICULAR PURPOSE, CONSEQUENTIAL OR INCIDENTAL DAMAGES, MERCHANTABILITY, OR INFRINGEMENT OF ANY PATENT, COPYRIGHT OR OTHER INTELLECTUAL PROPERTY RIGHT. MACOM FURTHER DOES NOT WARRANT THE ACCURACY OR COMPLETENESS OF THE INFORMATION, TEXT, GRAPHICS OR OTHER ITEMS CONTAINED WITHIN THESE MATERIALS. MACOM SHALL NOT BE LIABLE FOR ANY SPECIAL, INDIRECT, INCIDENTAL, OR CONSEQUENTIAL DAMAGES, INCLUDING WITHOUT LIMITATION, LOST REVENUES OR LOST PROFITS, WHICH MAY RESULT FROM THE USE OF THESE MATERIALS.

MACOM products are not intended for use in medical, lifesaving or life sustaining applications. MACOM customers using or selling MACOM products for use in such applications do so at their own risk and agree to fully indemnify MACOM for any damages resulting from such improper use or sale.