

CBM-40-UVX

Ultraviolet Chip On Board LEDs

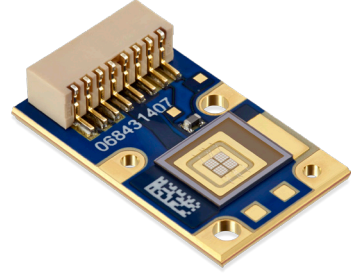

Table of Contents

Technology Overview	2
Binning Structure	3
Ordering Information	4
Ordering Bin Kits	4
Optical & Electrical Characteristics	5
Typical Spectrum	7
Radiation Pattern	7
Thermal Resistance	8
Mechanical Dimensions	9
Shipping Tray Outline	10
Packing and Shipping Specifications	11
Revision History	12

Features:

- Mosaic Array UV LED chipset with surface emitting area of 4 mm², 1:1 aspect ratio
- Chip on board package eliminates the need for complicated assembly process
- Vertical chip UV LED technology for high power density and uniform emission
- Wide Range of UVA Wavelengths
- High thermal conductivity common cathode copper coreboard package
- Low-profile window for efficient coupling into small-etendue systems
- Can be operated at drive currents up to 8 A
- Environmentally friendly: REACH, RoHS and Halogen compliant

Applications:

- 3D printing and Additive Manufacturing
- Machine Vision
- Fiber-coupled illumination
- Maskless Lithography
- Medical and Scientific Instrumentation

Technology Overview

Luminus LEDs benefit from innovations in device technology, chip packaging and thermal management. This suite of technologies give engineers and system designers the freedom to develop solutions both high in power and efficiency.

Luminus Mosaic Array LED Technology

Luminus' vertical chip technology enables LED chips with uniform brightness over the entire chip surface. The optical power and brightness produced by these densely packed chips enable solutions not just to replace arc and halogen lamps but also create novel solutions.

Packaging Technology

Thermal management is critical in high power LED applications. With a thermal resistance from junction to board of 0.7 °C/W, the CBM-40-UVX has one of the lowest thermal resistances of UV LEDs in the market. The low Rth, along with Luminus chip technology allows users to drive the LEDs at high current densities while maintaining a low junction temperature, thereby resulting in brighter solutions and longer lifetimes.

Reliability

Luminus LEDs are one of the most reliable light sources in the world. They pass a rigorous suite of environmental and mechanical stress tests, including mechanical shock, vibration, temperature cycling and humidity, and have been qualified for use in high power and high current applications. Luminus UV LEDs are designed for the most demanding applications with median lifetimes exceeding 30,000 hours.

Environmental Benefits

Luminus LEDs help reduce power consumption and the amount of hazardous waste entering the environment. All Luminus LEDs are RoHS and Halogen compliant and free of hazardous materials, including lead and mercury.

Binning Structure

CBM-40-UVX LEDs are specified for flux and peak wavelength at a drive current of 3 A (750 mA/mm²) with a 20 ms pulse at 25°C and placed into one of the following Power Bins and Wavelength Bins.

Power Bins¹

Color	Power Flux Bin (FF)	Minimum Flux (W)	Maximum Flux (W)
UV	DA	4.0	4.3
	DB	4.3	4.7
	DC	4.7	5.0
	EA	5.0	5.5
	EB	5.5	6

Note 1: Luminus maintains a +/- 6% tolerance on power measurements.

Peak Wavelength Bins

Color	Wavelength Bin (WWW)	Minimum Wavelength (nm)	Maximum Wavelength (nm)
UV	365	365	370
	370	370	375
	380	380	385
	385	385	390
	400	400	405
	405	405	410

Ordering Information

Products	Ordering Part Number	Description
CBM-40-UVX	CBM-40-UV-X32-FFWWW-2#	CBM-40-UVX Mosaic Array chipset consisting of 4 UV chips, a thermistor, and a connector on a copper-core PCB.

Part Number Nomenclature

CBM — 40 — UV — X32 — FFWWW-2#

Product Family	Chip Area	Color	Package Configuration	Bin Kit ^{2,3}
CBM: Copper-core PCB, Mosaic Array	40: 4 mm ²	UV = Ultraviolet	X32: 26.5 mm x 16.0 mm	See ordering bin kits table below for complete bin definition

Note 2: A Bin Kit represents a group of flux and wavelength bins that are shippable for a given ordering part number. Individual bins are not orderable..

Note 3: Flux Bin listed is minimum bin shipped - higher bins may be included at Luminus' discretion

Ordering Bin Kits

Wavelength Range	Luminous Flux		Wavelength Bins	Ordering Bin Kit Number
	Bin Kit Flux Code	Min. Flux		
380-390	DC	4.7	380	DC380-21
			385	DC385-21
			380, 385	DC380-22

400-410	DA	4.0	400	DA400-21
			405	DA405-21
			400, 405	DA400-22

Optical & Electrical Characteristics ($T_{hs} = 25^{\circ}\text{C}$)

UV				
Parameter	Symbol	Values ⁴		Unit
Peak Wavelength Range	λ	380-390	400-410	nm
Test Current for binning ⁵	I	3.0	3.0	A
Current Density at Test Current	j	0.75	0.75	A/mm ²
Peak Wavelength Typ.	λ_p	385	405	nm
Forward Voltage	$V_{F\ min}$	2.9	2.9	V
	V_F	3.5	3.3	V
	$V_{F\ max}$	3.7	3.7	V
Radiometric Flux ⁶	Φ_{typ}	5.0	4.3	W
FWHM at 50% of Φ	$\Delta\lambda_{1/2}$	15	15	nm

Parameter	Symbol	Values	Unit
Absolute Minimum Current (CW or Pulsed) ⁷	I_{min}	0.2	A
Absolute Maximum Current (CW) ⁸	I_{max}	8	A
Absolute Maximum Surge Current ⁸ (Frequency > 240 Hz, duty cycle =10%, t=1ms)	I_s	10	A
Maximum Junction Temperature ⁸	T_{jmax}	125	$^{\circ}\text{C}$
Storage Temperature Range	T_s	-40 to +100	$^{\circ}\text{C}$
Emitting Area ⁹	A_e	4.8	mm ²
Emitting Area Dimensions		2.2 x 2.2	mm x mm

Note 4: Unless otherwise noted, values listed are typical. Devices are production tested and specified at 3 A with a 20 ms pulse at 25°C.

Note 5: While CBM40-UVX devices are tested at 3 A, they can be driven at CW currents ranging from 200 mA to 8 A and at duty cycles ranging from 1% to 100%. Drive current and duty cycle should be adjusted as necessary to maintain the junction temperature desired to meet application lifetime requirements.

Note 6: Typical radiometric flux is for reference only. Minimum flux values are guaranteed based on the bin kit ordered. For product roadmap and future performance of devices, contact Luminus.

Note 7: Special design considerations must be observed for operation under 1 A. Please contact Luminus for further information.

Note 8: CBM-40-UVX LEDs are designed for operation to an absolute maximum current as specified above. Product lifetime data is specified at or below maximum drive current. Sustained operation beyond absolute maximum currents will result in a reduction of device life time. Actual device lifetimes will also depend on junction temperature and operation beyond maximum junction temperature is not recommended. Contact Luminus for lifetime derating curves and for further information. In pulsed operation, rise time from 10-90% of forward current should be longer than 0.5 μ seconds.

Note 9: Emitting Area is for reference only and subject to change without notice.

Optical & Electrical Characteristics

Relative Power vs. Forward Current

$\phi/\phi_{(3A)}$, 20 ms pulse, $T_j = 25^\circ\text{C}$

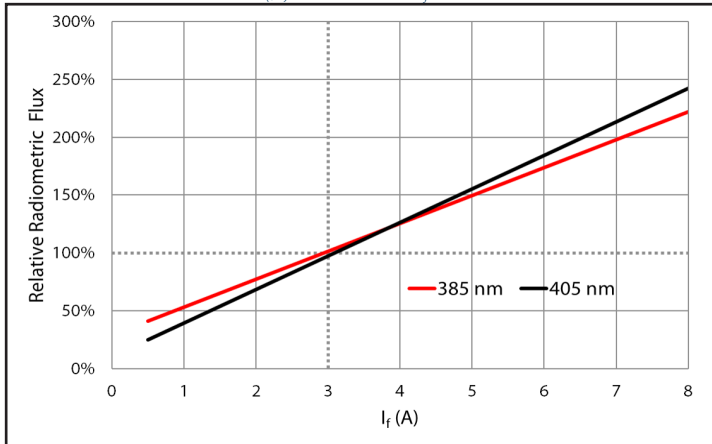

Relative Power vs. Junction Temperature

$\phi/\phi_{(25^\circ\text{C})}$, 20 ms pulse, 3A

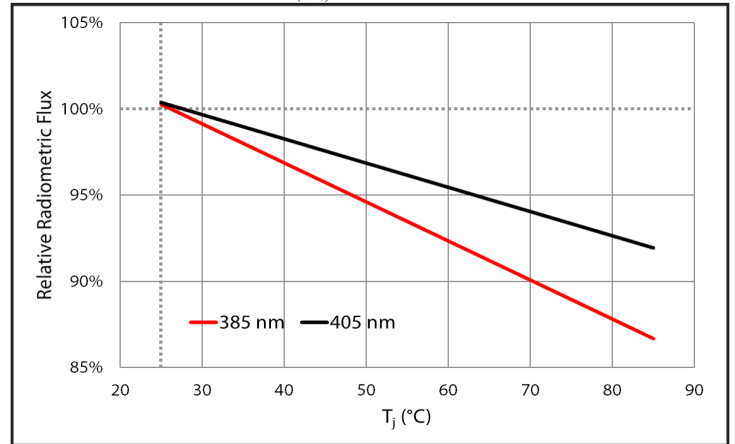

Peak Wavelength Shift vs. Forward Current

$\lambda_p = \lambda_p(I_f) - \lambda_p(3A)$, 20 ms pulse, $T_j = 25^\circ\text{C}$

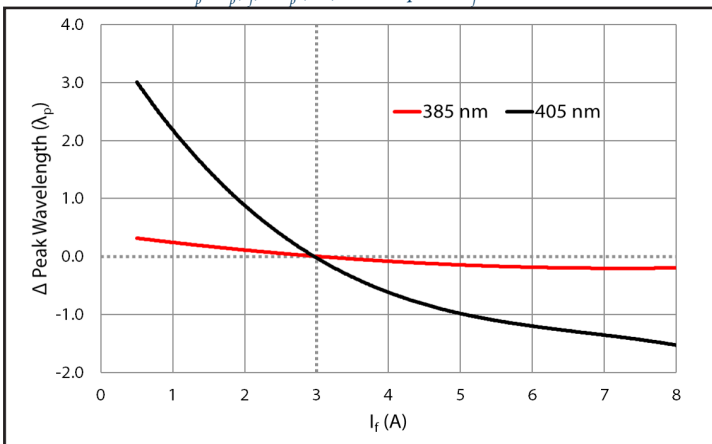

Peak Wavelength Shift vs. Junction Temperature

$\lambda_p = \lambda_p(T_j) - \lambda_p(25^\circ\text{C})$, 20 ms pulse, $I_f = 3A$

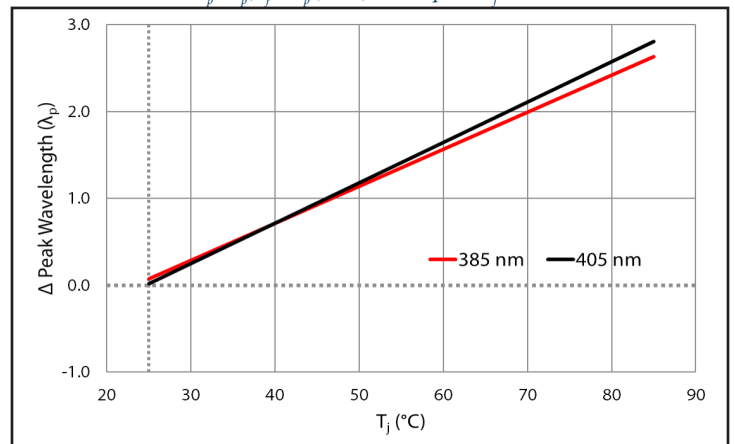

Forward Voltage vs Forward Current

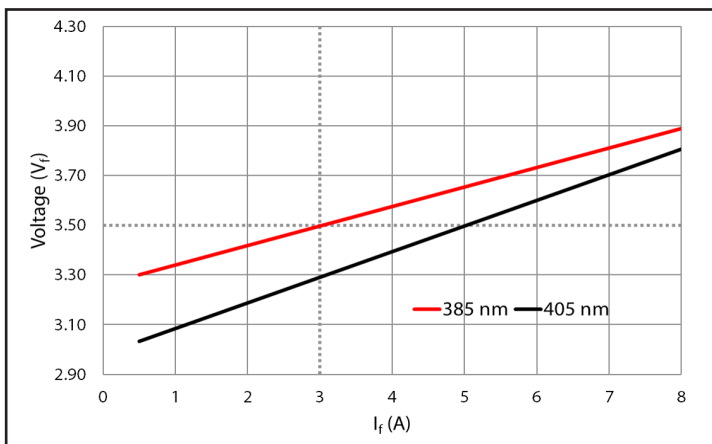

Forward Voltage Shift vs. Junction Temperature

$\Delta V_f = V_f(T_j) - V_f(25^\circ\text{C})$, 20 ms pulse, $I_f = 3A$

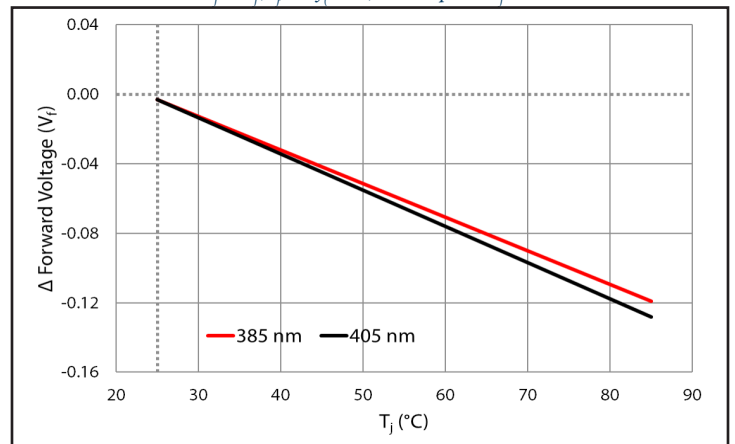

Typical Spectrum⁹

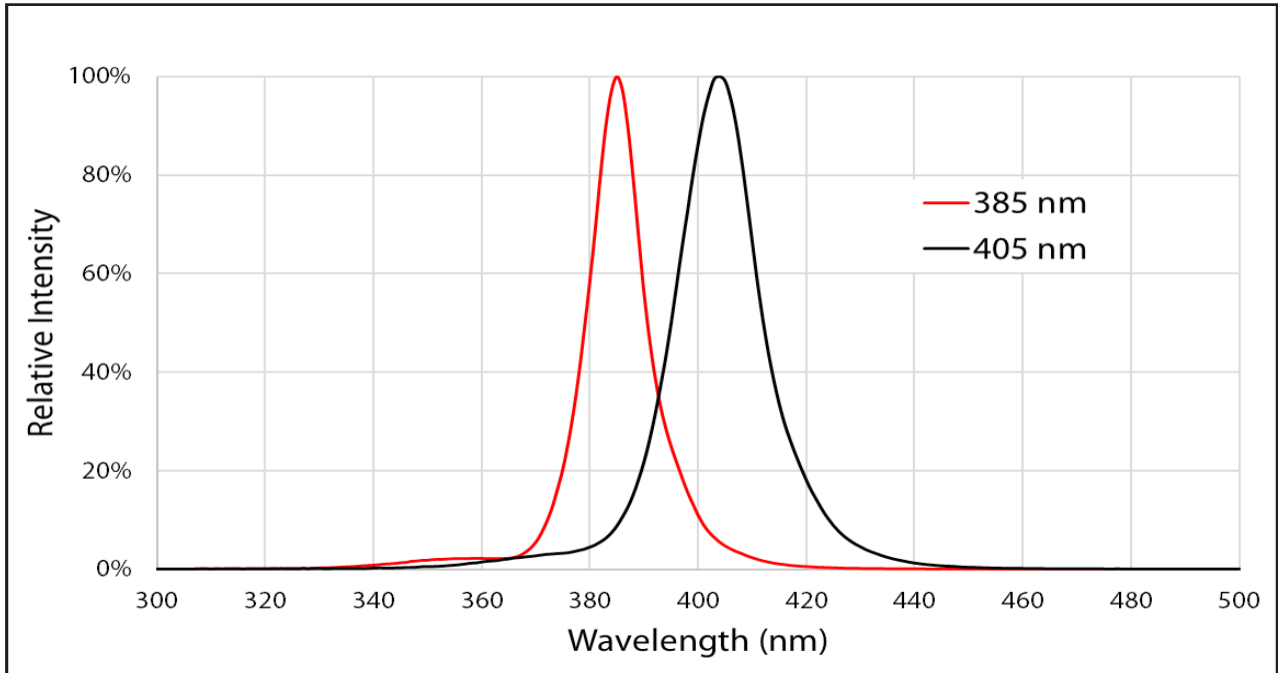

Radiation Pattern¹⁰

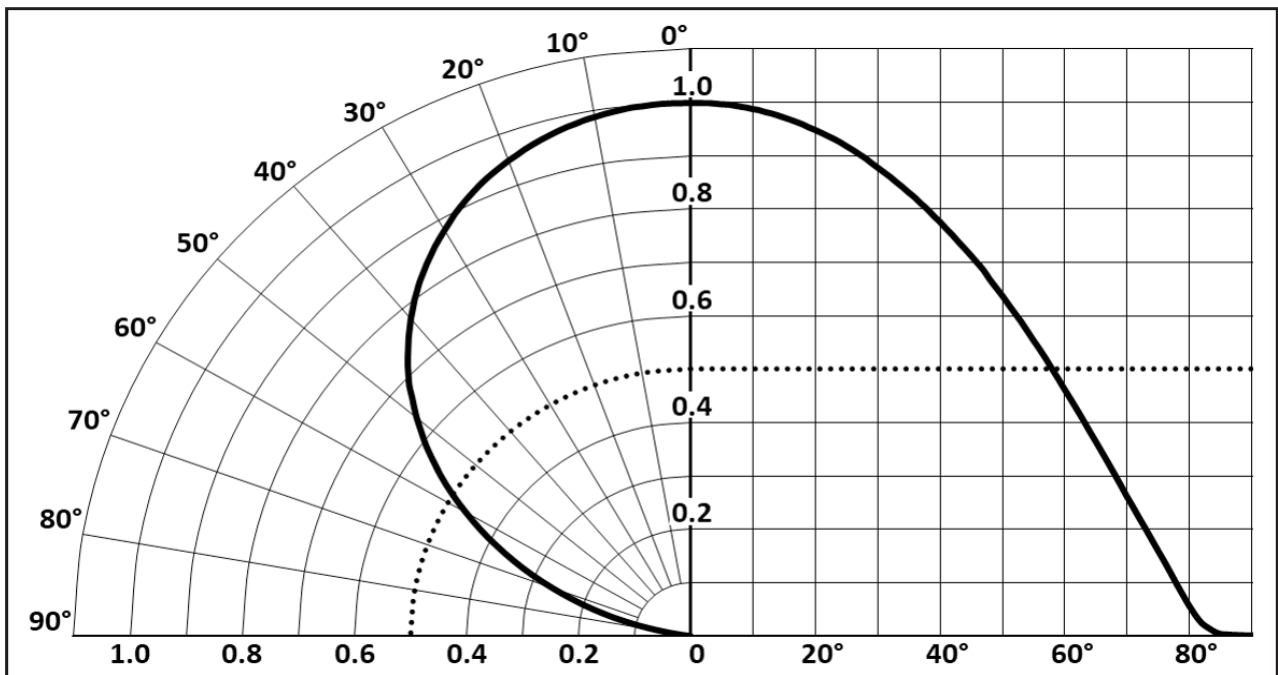

Note 9: Typical spectrum at 3 A drive current.

Note 10: Detailed information on radiation pattern including ray trace files can be found at: <http://www.luminus.com>

Thermal Resistance

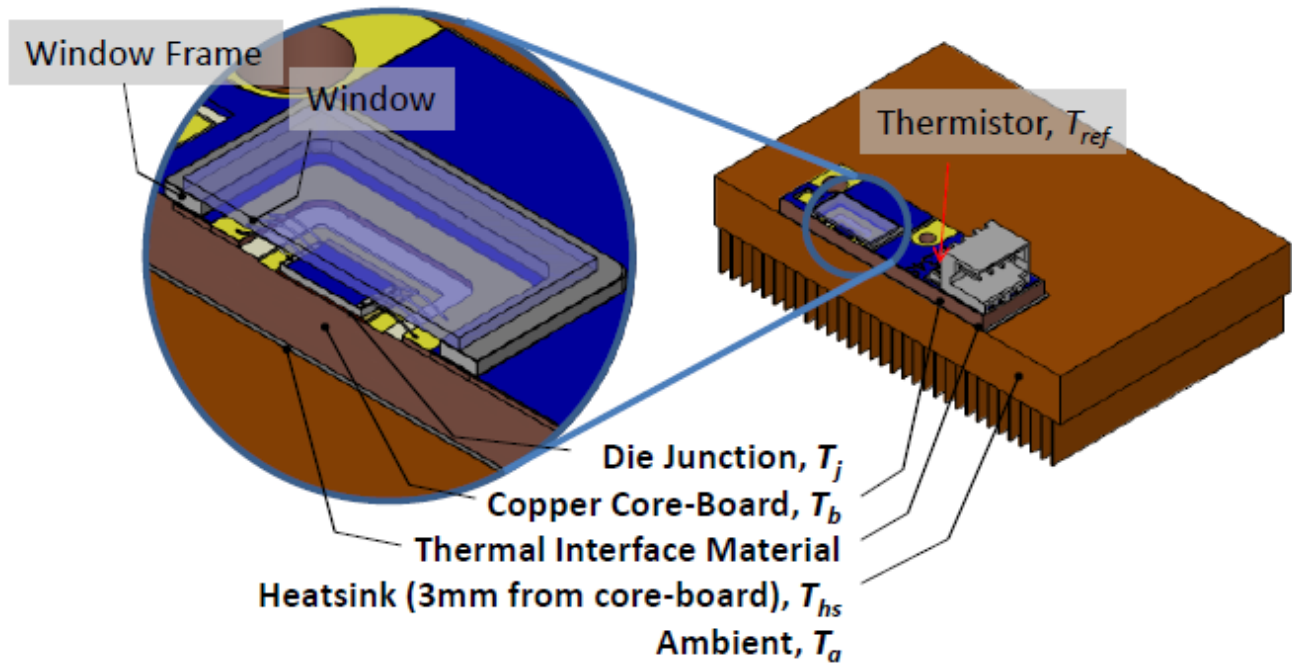

Thermistor Information

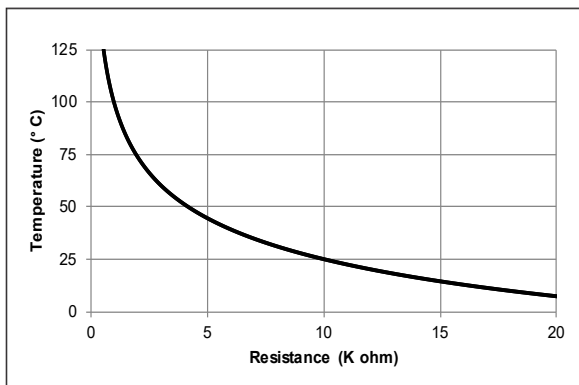

$R_{\theta j-b}^{11}$	0.7 °C/W
$R_{\theta b-hs}$	0.15 °C/W
$R_{\theta j-hs}^{12}$	0.85 °C/W
$R_{\theta j-ref}$	0.88 °C/W

Note 11: Electrical thermal resistance based on input electrical power at 3A and measured per JESD51-14

Note 12: Thermal Resistance is based on eGraf 1205 Thermal interface.

The thermistor mounted CBM-40-UVX coreboards is from Murata Manufacturing Co. The global part number is NCP18XH103J03RB. Please see <http://www.murata.com/> for details on calculating thermistor temperature. Contact Luminus for more information on use of the thermistor.

Important note: The CBM-40-UVX copper PCB is electrically active with a common cathode polarity.

Mechanical Dimensions

DIMENSIONS IN MILLIMETERS

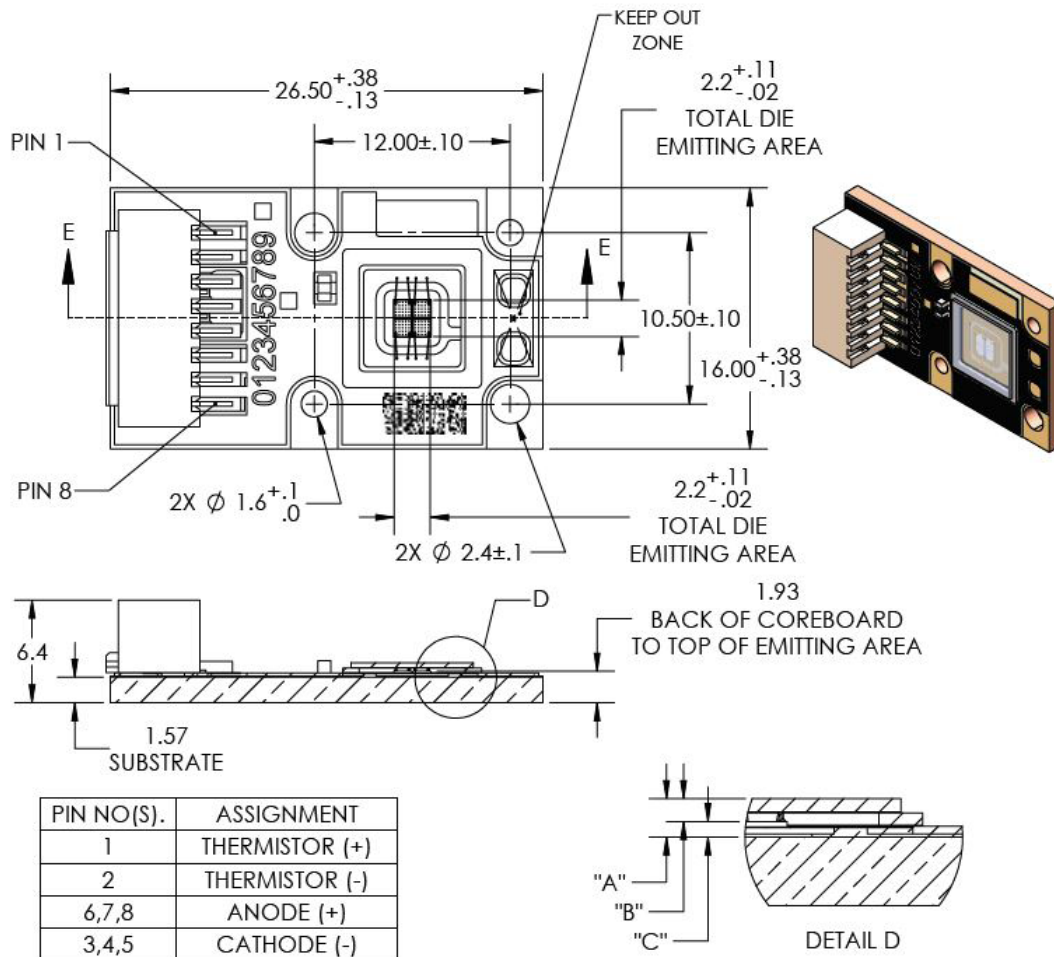

DIMENSION NAME	DESCRIPTION	NOMINAL DIMENSION	TOLERANCE
"A"	TOP OF METAL SUBSTRATE TO TOP OF WINDOW	.88	±.13
"B"	TOP OF EMITTING AREA TO TOP OF WINDOW	.53	±.11
"C"	TOP OF METAL SUBSTRATE TO TOP OF EMITTING AREA	.36	±.02

DWG-002938

Connector- MOLEX Part Number: 874380843 or Global Part Number: WTB16-081SF.

Note: The coreboards and windows of LEDs may have minor cosmetic differences, for e.g. slightly different hues, because of different supply sources. These differences are only cosmetic and do not affect form, fit or function of the LED.

Shipping Tray Outline

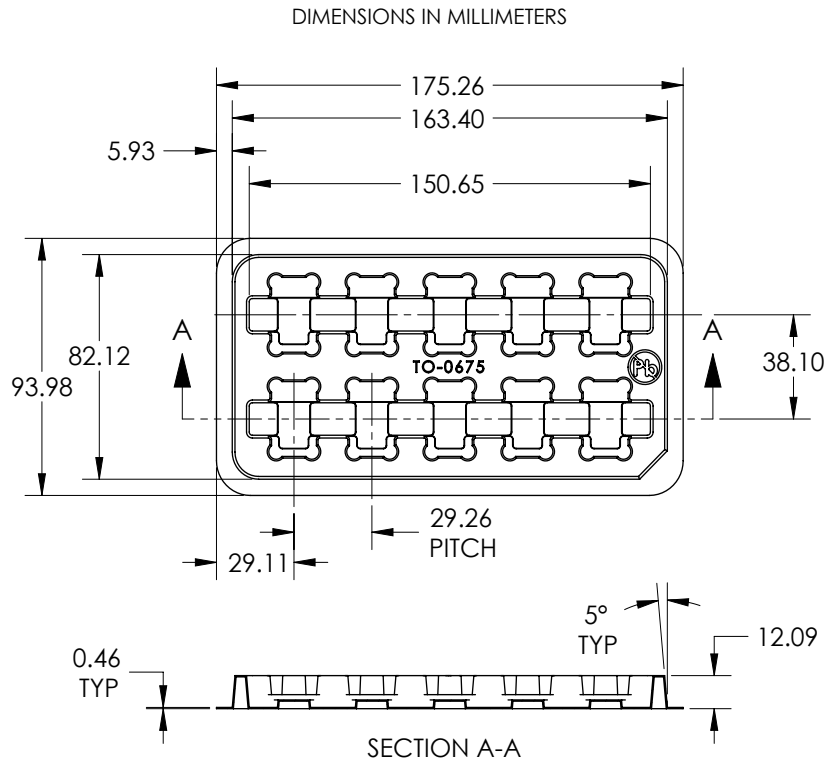

TOP TRAY SHOWN TRANSPARENT
FOR REFERENCE ONLY

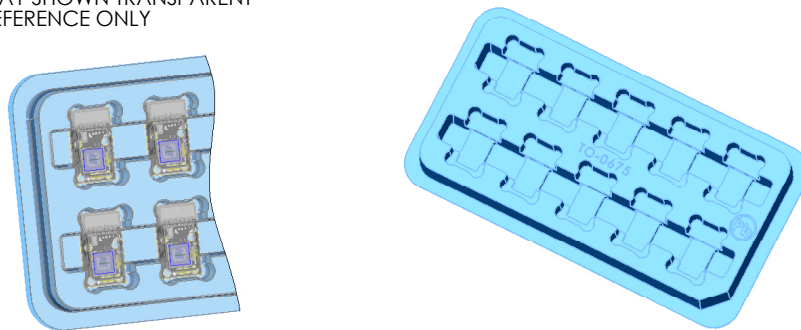

Packing and Shipping Specifications

Packing Configuration	Qty /Pack	Box Dimensions (diameter x W, mm)	Gross Weight (kg)
Stack of 5 trays with 10 devices per tray Each pack is enclosed in ESD bag	50	95 x 176 x 50	0.45

Product Label Specification

Label Fields (subject to change):

- 6-8 digit Box number (for Luminus internal use)
- Luminus ordering part number
- Quantity of devices in pack
- Part number revision (for Luminus internal use)
- Customer's part number (optional)
- Flux Bin
- 2D Bar code

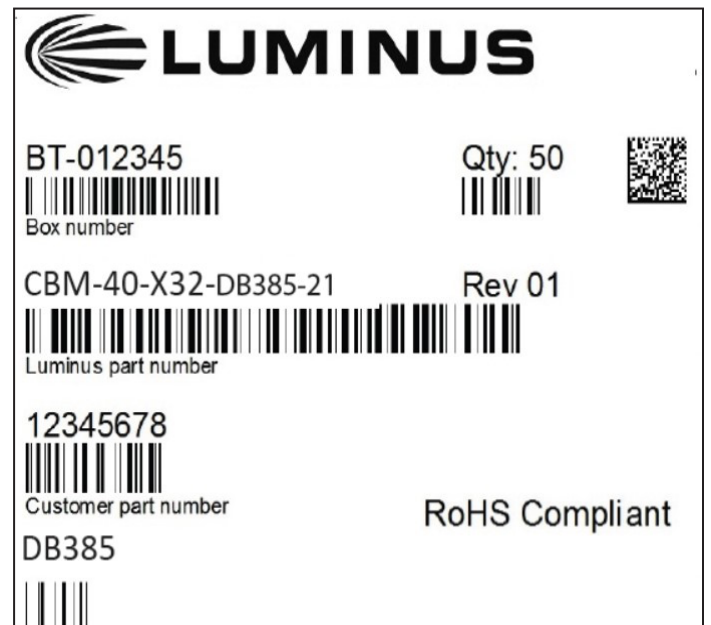

Sample label –for illustration only

Shipping Box

Shipping Box	Quantity	Material	Dimensions (L x W x H, mm)
Carton Box	1-20 packs	S4651	560 x 560 x 200

Revision History

Rev	Date	Description of Change
01	06/01/2018	Initial Release
02	6/13/2018	Tolerances in Mechanical Dimensions, Emitting Area dimensions

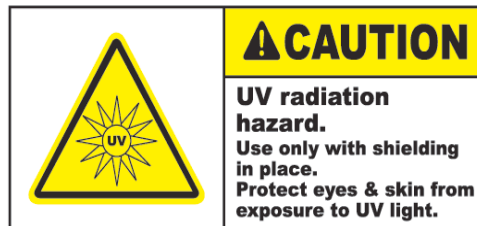

The products, their specifications and other information appearing in this document are subject to change by Luminus Devices without notice. Luminus Devices assumes no liability for errors that may appear in this document, and no liability otherwise arising from the application or use of the product or information contained herein. None of the information provided herein should be considered to be a representation of the fitness or suitability of the product for any particular application or as any other form of warranty. Luminus Devices' product warranties are limited to only such warranties as accompany a purchase contract or purchase order for such products. Nothing herein is to be construed as constituting an additional warranty. No information contained in this publication may be considered as a waiver by Luminus Devices of any intellectual property rights that Luminus Devices may have in such information.

This product is protected by U.S. Patents 6,831,302; 7,074,631; 7,083,993; 7,084,434; 7,098,589; 7,105,861; 7,138,666; 7,166,870; 7,166,871; 7,170,100; 7,196,354; 7,211,831; 7,262,550; 7,274,043; 7,301,271; 7,341,880; 7,344,903; 7,345,416; 7,348,603; 7,388,233; 7,391,059 Patents Pending in the U.S. and other countries.