

Main Features

Symbol	Value	Unit
$I_{T(RMS)}$	1.5	A
V_{DRM} / V_{RRM}	600	V
I_{GT}	100	μA

Applications

The S602ECS is specifically designed for Gas Ignition applications that require high pulse surge current capability.

Description

This new .8 A sensitive gate SCR in an TO-92 package with a GAK pin out, offers a high static component series with a high static dv/dt and a low turn off (t_q) time by the use of small die planar construction implementation. All SCR's junctions are glass-passivated to ensure long term reliability and parametric stability.

Features

- Surge capability >15Amps
- High dv/dt noise immunity
- Improved turn-off time (t_q) $\leq 35 \mu s$
- TO-92 G-A-K pinout
- Sensitive gate for direct microprocessor interface
- RoHS compliant and Halogen-Free

Schematic Symbol

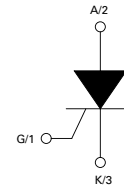

Absolute Maximum Ratings

Symbol	Parameter		Value	Unit	
$I_{T(RMS)}$	RMS on-state current (full sine wave)	$T_C = 65^\circ C$	1.5	A	
$I_{T(AV)}$	Average on-state current	$T_C = 65^\circ C$	0.95	A	
I_{TSM}	Non repetitive surge peak on-state current (Single cycle, T_J initial = $25^\circ C$)	F = 50 Hz	14.0	A	
		F = 60 Hz	16.8		
I^2t	I^2t Value for fusing	$t_p = 10$ ms	F = 50 Hz	0.78	A^2s
		$t_p = 8.3$ ms	F = 60 Hz	0.93	
di/dt	Critical rate of rise of on-state current $I_G = 10mA$	$T_J = 125^\circ C$	50	$A/\mu s$	
I_{GM}	Peak gate current	$t_p = 10 \mu s$	$T_J = 125^\circ C$	1.0	A
$P_{G(AV)}$	Average gate power dissipation	$T_J = 125^\circ C$	0.1	W	
T_{stg}	Storage junction temperature range			-40 to 150	$^\circ C$
T_J	Operating junction temperature range			-40 to 125	$^\circ C$

Electrical Characteristics ($T_J = 25^\circ\text{C}$, unless otherwise specified)

Symbol	Description	Test Conditions	S602ECS		Unit
			Min	Max	
I_{GT}	DC Gate Trigger Current	$V_D = 12\text{V}$ $R_L = 60\ \Omega$	20	100	μA
V_{GT}	DC Gate Trigger Voltage		—	0.8	V
V_{GRM}	Peak Reverse Gate Voltage	$I_{RG} = 10\ \mu\text{A}$	5	—	V
I_H	Holding Current	$R_{GK} = 1\ \text{k}\Omega$	—	3	mA
(dv/dt)s	Critical Rate-of-Rise of Off-State Voltage	$T_J = 125^\circ\text{C}$ $V_D = V_{DRM} / V_{RRM}$ Exponential Waveform $R_{GK} = 1\ \text{k}\Omega$	50	—	V/ μs
t_q	Turn-Off Time	$T_J = 125^\circ\text{C}$ @ 600 V $R_{GK} = 1\ \text{k}\Omega$	—	35	μs
t_{gt}	Turn-On Time	$I_G = 10\text{mA}$ PW = 15 μsec $I_T = 3.0\text{A}$ (pk)	—	3	μs

Static Characteristics ($T_J = 25^\circ\text{C}$, unless otherwise specified)

Symbol	Description	Test Conditions	Value		Unit
			Min	Max	
V_{TM}	Peak On-State Voltage	$I_{TM} = 4\text{A}$ (pk)	—	1.8	V
I_{DRM}	Off-State Current, Peak Repetitive	$T_J = 25^\circ\text{C}$ @ $V_D = V_{DRM}$ $R_{GK} = 1\ \text{k}\Omega$	—	5	μA
		$T_J = 125^\circ\text{C}$ @ $V_D = V_{DRM}$ $R_{GK} = 1\ \text{k}\Omega$	—	500	μA

Thermal Resistances

Symbol	Parameter	Value	Unit
$R_{\theta(J-C)}$	Junction to case (AC)	50	$^\circ\text{C}/\text{W}$
$R_{\theta(J-A)}$	Junction to ambient		160

$I_T = 1.5\text{A}_{(RMS)}$, 60Hz AC resistive load condition, 100% conduction.

Figure 1: Normalized DC Gate Trigger Current vs. Junction Temperature

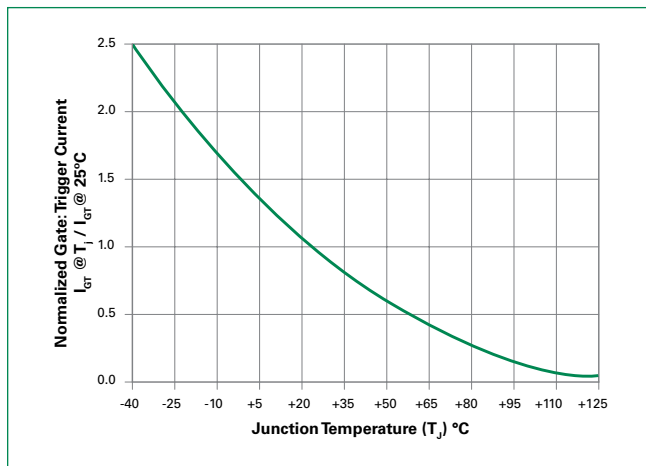

Figure 2: Normalized DC Holding Current vs. Junction Temperature

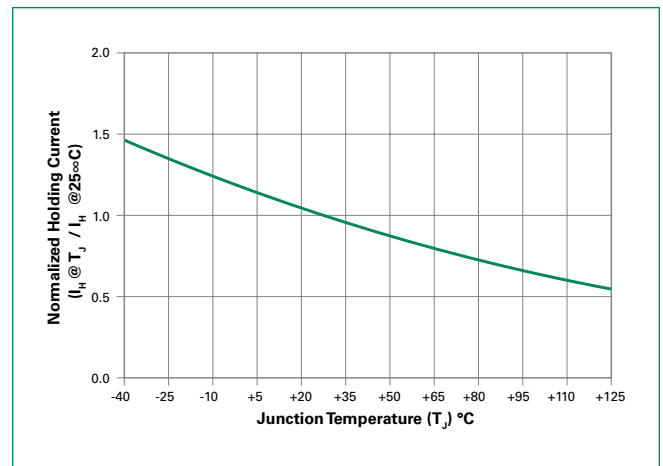

Figure 3: Normalized DC Gate Trigger Voltage vs. Junction Temperature

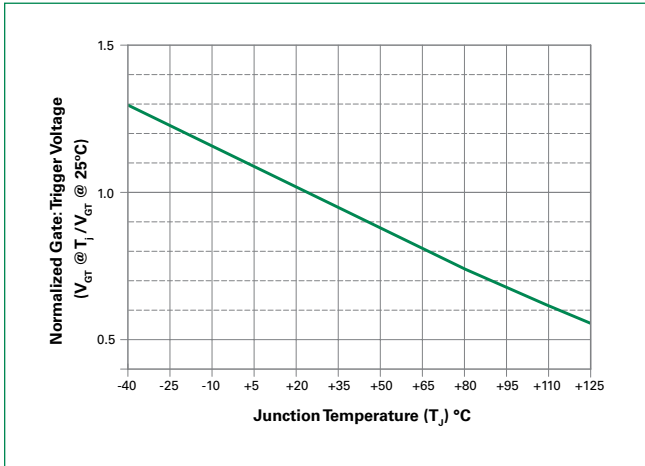

Figure 4: On-State Current vs. On-State Voltage (Typical)

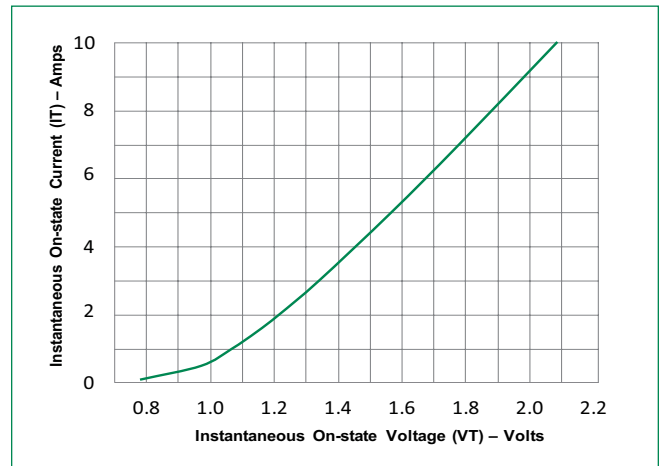

Figure 5: Power Dissipation (Typical) vs. RMS On-State Current

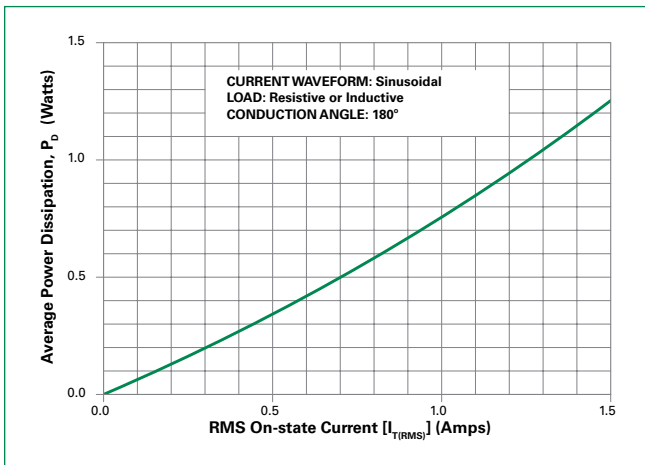

Figure 6: Maximum Allowable Case Temperature vs. On-State Current

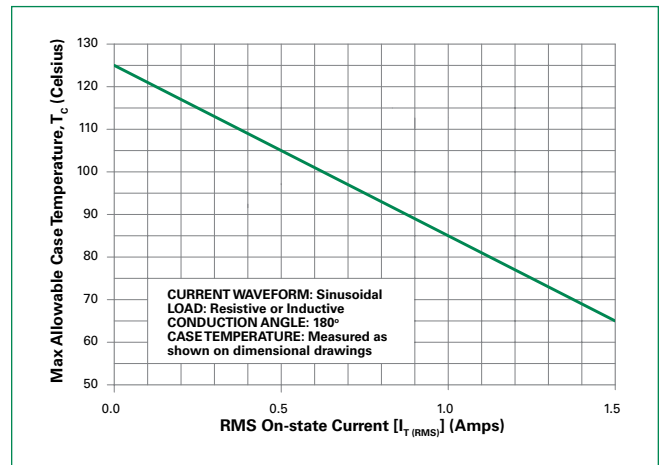

Figure 6: Surge Peak On-State Current vs. Number of Cycles

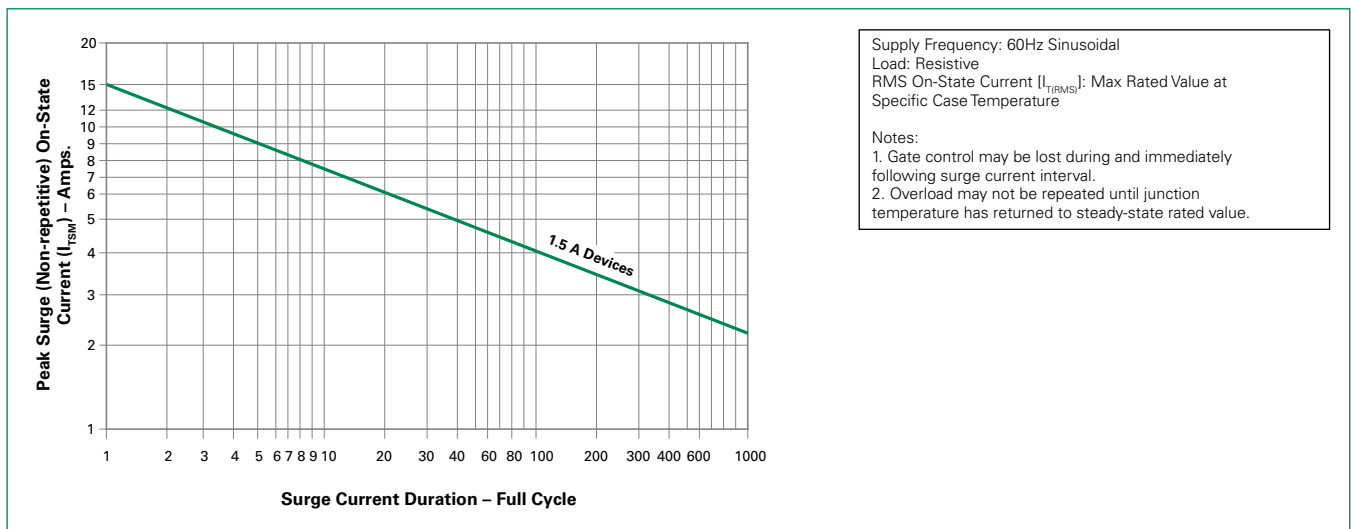

Figure 7: Typical DC Gate Trigger Current with R_{GK} vs. Junction Temperature

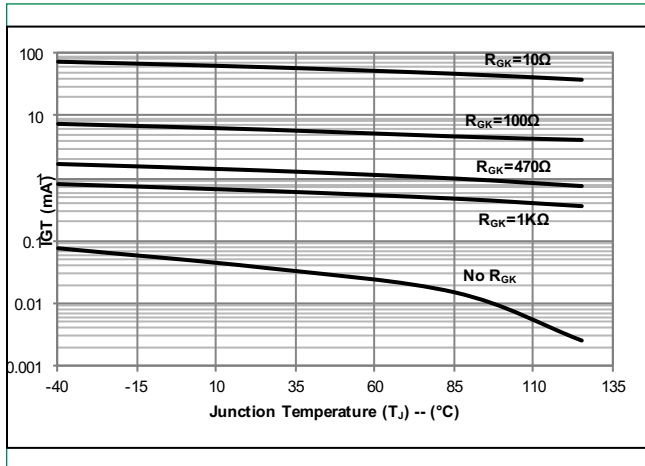

Figure 8: Typical DC Holding Current with R_{GK} vs. Junction Temperature

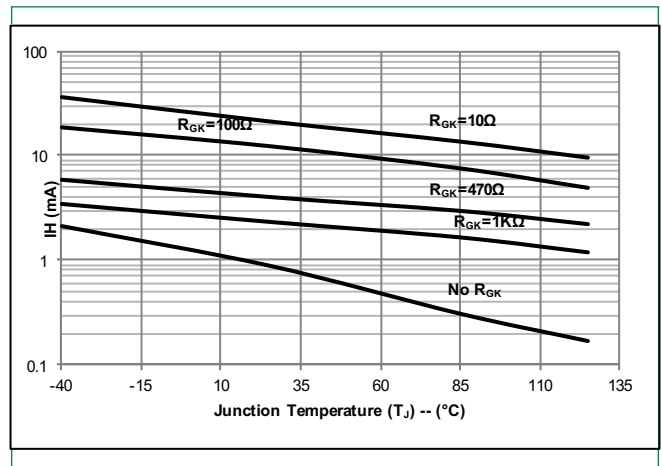

Figure 9: Typical Turn Off Time with R_{GK} vs. Junction Temperature

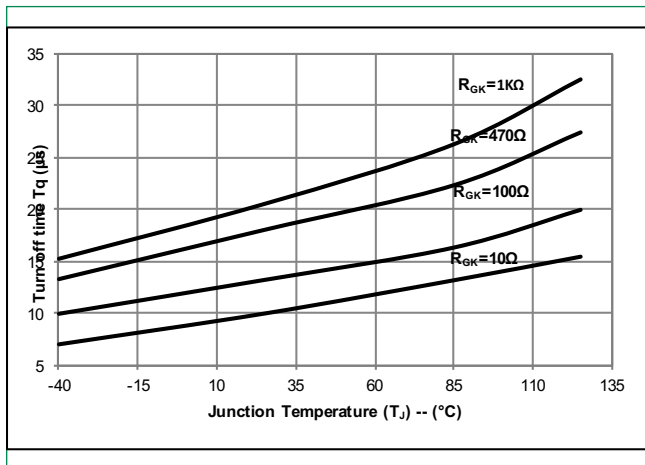
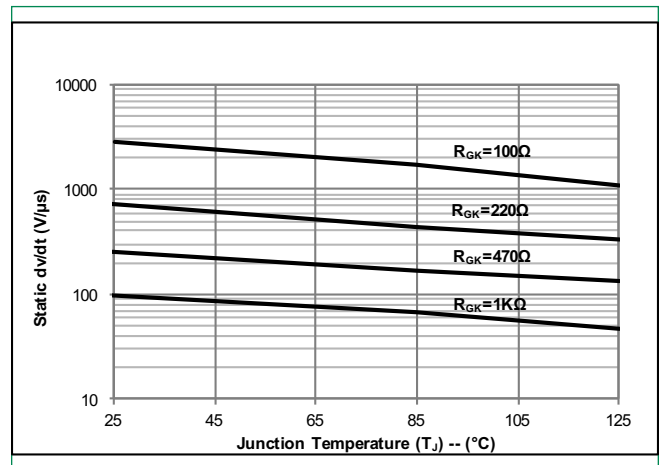
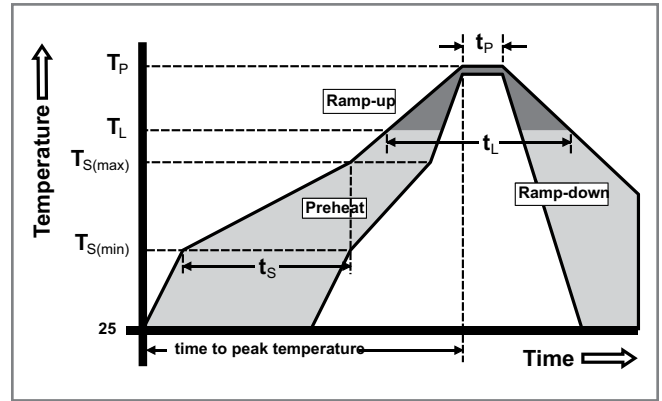

Figure 10: Typical Static DV/DT with R_{GK} vs. Junction Temperature



Soldering Parameters

Reflow Condition		Pb – Free assembly
Pre Heat	- Temperature Min ($T_{s(min)}$)	150°C
	- Temperature Max ($T_{s(max)}$)	200°C
	- Time (min to max) (t_s)	60 – 180 secs
Average ramp up rate (Liquidus Temp (T_L) to peak)		5°C/second max
$T_{s(max)}$ to T_L - Ramp-up Rate		5°C/second max
Reflow	- Temperature (T_L) (Liquidus)	217°C
	- Time (min to max) (t_s)	60 – 150 seconds
Peak Temperature (T_p)		260 ^{+0/-5} °C
Time within 5°C of actual peak Temperature (t_p)		20 – 40 seconds
Ramp-down Rate		5°C/second max
Time 25°C to peak Temperature (T_p)		8 minutes Max.
Do not exceed		280°C



Physical Specifications

Terminal Finish	100% Matte Tin-plated.
Body Material	UL Recognized epoxy meeting flammability rating V-0.
Lead Material	Copper Alloy

Design Considerations

Careful selection of the correct component for the application's operating parameters and environment will go a long way toward extending the operating life of the Thyristor. Good design practice should limit the maximum continuous current through the main terminals to 75% of the component rating. Other ways to ensure long life for a power discrete semiconductor are proper heat sinking and selection of voltage ratings for worst case conditions. Overheating, overvoltage (including dv/dt), and surge currents are the main killers of semiconductors. Correct mounting, soldering, and forming of the leads also help protect against component damage.

Environmental Specifications

Test	Specifications and Conditions
AC Blocking	MIL-STD-750, M-1040, Cond A Applied Peak AC voltage @ 125°C for 1008 hours
Temperature Cycling	MIL-STD-750, M-1051, 100 cycles; -40°C to +150°C; 15-min dwell-time
Temperature/Humidity	EIA / JEDEC, JESD22-A101 1008 hours; 320V - DC; 85°C; 85% rel humidity
High Temp Storage	MIL-STD-750, M-1031, 1008 hours; 150°C
Low-Temp Storage	1008 hours; -40°C
Resistance to Solder Heat	MIL-STD-750 Method 2031
Solderability	ANSI/J-STD-002, category 3, Test A
Lead Bend	MIL-STD-750, M-2036 Cond E

Dimensions

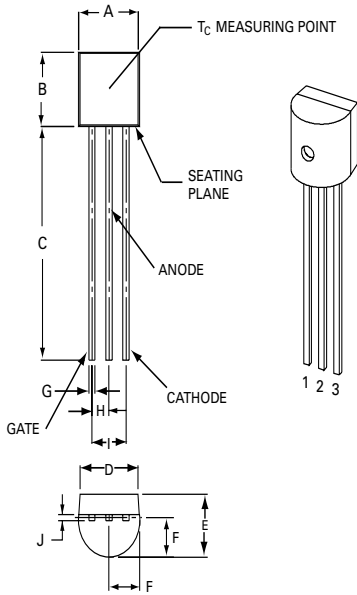

Dimensions	Inches		Millimeters	
	Min	Max	Min	Max
A	0.175	0.205	4.450	5.200
B	0.170	0.210	4.320	5.330
C	0.500	—	12.700	—
D	0.135	—	3.430	—
E	0.125	0.165	3.180	4.190
F	0.080	0.105	2.040	2.660
G	0.016	0.021	0.407	0.533
H	0.045	0.055	1.150	1.390
I	0.095	0.105	2.420	2.660
J	0.015	0.020	0.380	0.500

Packing Options

Part Number	Marking	Weight	Packing Mode	Base Quantity
S602ECS	S602ECS	0.170 g	Bulk	2500
S602ECSAP	S602ECS	0.170 g	Ammo Pack	2000
S602ECSR	S602ECS	0.170 g	Tape & Reel	2000

Part Numbering System

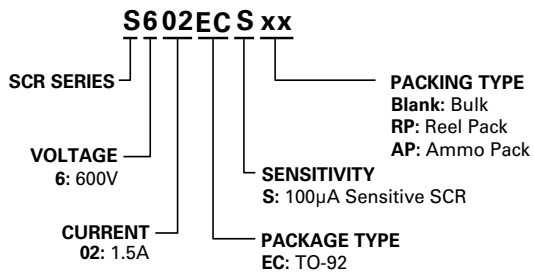

Part Marking System

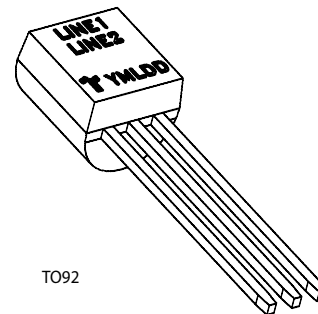

TO-92 (3-lead) Reel Pack (RP) Radial Leaded Specifications

Meets all EIA-468-C Standards

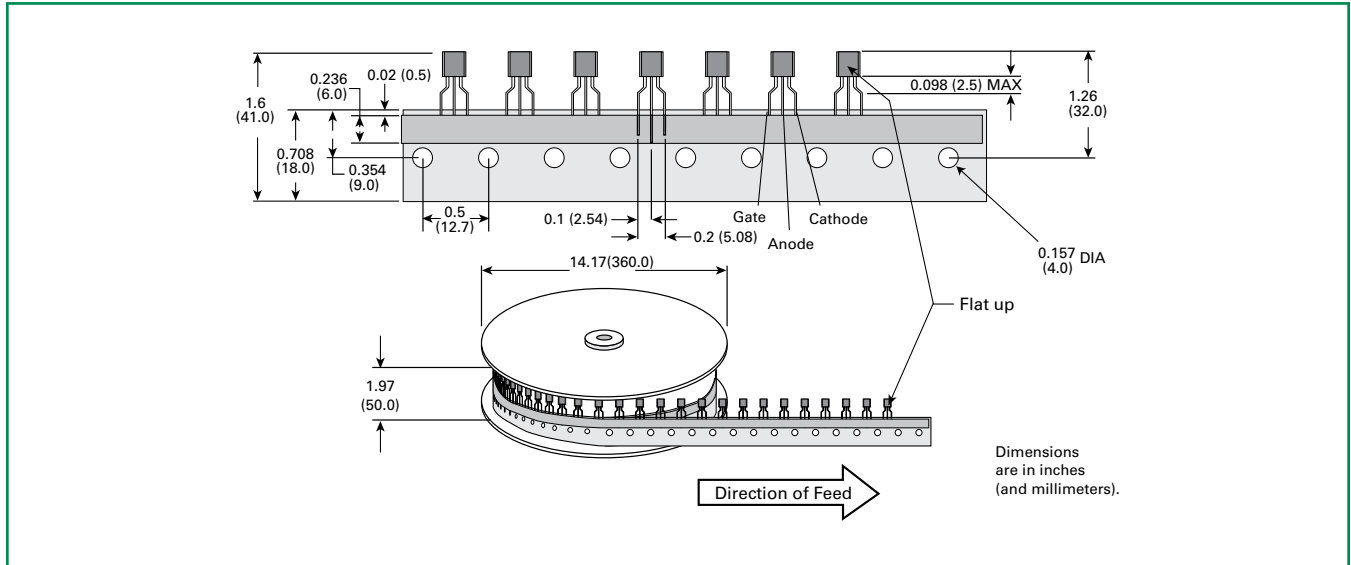

TO-92 (3-lead) Ammo Pack (AP) Radial Leaded Specifications

Meets all EIA-468-C Standards

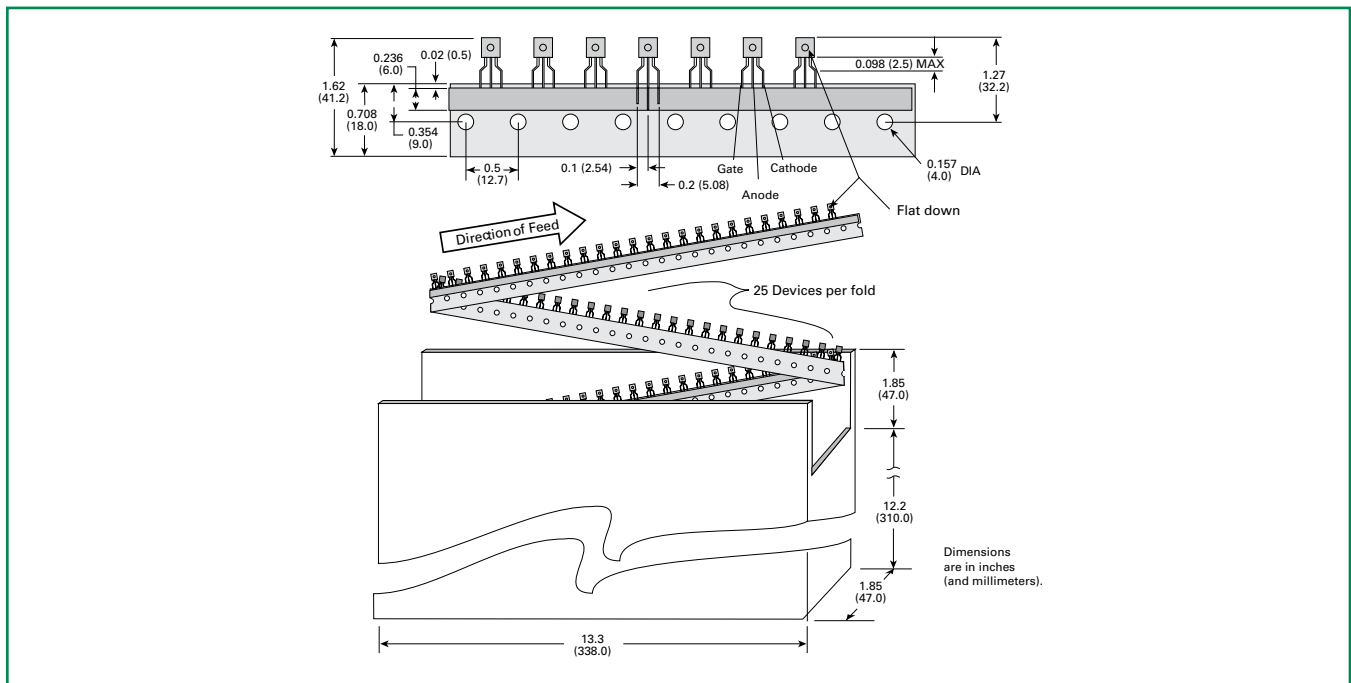

Disclaimer Notice - Information furnished is believed to be accurate and reliable. However, users should independently evaluate the suitability of and test each product selected for their own applications. Littelfuse products are not designed for, and may not be used in, all applications. Read complete Disclaimer Notice at www.littelfuse.com/disclaimer-electronics.