



**LR Series
Transmitter Module
Data Guide**

Wireless made simple[®]

Warning: Some customers may want Linx radio frequency (“RF”) products to control machinery or devices remotely, including machinery or devices that can cause death, bodily injuries, and/or property damage if improperly or inadvertently triggered, particularly in industrial settings or other applications implicating life-safety concerns (“Life and Property Safety Situations”).

NO OEM LINX REMOTE CONTROL OR FUNCTION MODULE SHOULD EVER BE USED IN LIFE AND PROPERTY SAFETY SITUATIONS. No OEM Linx Remote Control or Function Module should be modified for Life and Property Safety Situations. Such modification cannot provide sufficient safety and will void the product’s regulatory certification and warranty.

Customers may use our (non-Function) Modules, Antenna and Connectors as part of other systems in Life Safety Situations, but only with necessary and industry appropriate redundancies and in compliance with applicable safety standards, including without limitation, ANSI and NFPA standards. It is solely the responsibility of any Linx customer who uses one or more of these products to incorporate appropriate redundancies and safety standards for the Life and Property Safety Situation application.

Do not use this or any Linx product to trigger an action directly from the data line or RSSI lines without a protocol or encoder/decoder to validate the data. Without validation, any signal from another unrelated transmitter in the environment received by the module could inadvertently trigger the action.

All RF products are susceptible to RF interference that can prevent communication. RF products without frequency agility or hopping implemented are more subject to interference. This module does not have a frequency hopping protocol built in.

Do not use any Linx product over the limits in this data guide. Excessive voltage or extended operation at the maximum voltage could cause product failure. Exceeding the reflow temperature profile could cause product failure which is not immediately evident.

Do not make any physical or electrical modifications to any Linx product. This will void the warranty and regulatory and UL certifications and may cause product failure which is not immediately evident.

Table of Contents

1	Description
1	Features
1	Applications
2	Ordering Information
2	Absolute Maximum Ratings
3	Electrical Specifications
4	Typical Performance Graphs
6	Pin Assignments
6	Pin Descriptions
7	Module Description
8	Theory of Operation
9	The Data Input
9	Using the PDN Line
10	Using the LADJ Line
10	Power Supply Requirements
11	Transferring Data
12	Typical Applications
13	ESD Concerns
14	Antenna Considerations
15	Helpful Application Notes from Linx
15	Protocol Guidelines
16	Interference Considerations
17	Pad Layout
17	Board Layout Guidelines
19	Microstrip Details
20	Production Guidelines
20	Hand Assembly
20	Automated Assembly
22	General Antenna Rules

LR Series Transmitter Module Data Guide



Description

The LR Series transmitter is ideal for the cost-effective wireless transfer of serial data, control, or command information in the favorable 260 to 470MHz band. When paired with a compatible Linx receiver, a reliable wireless link is formed, capable of transferring serial data at rates of up to 10,000bps at distances of up to 3,000 feet (1,000m). Applications operating over shorter distances or at lower data rates also benefit from increased link reliability and superior noise immunity. The transmitter's synthesized architecture delivers outstanding stability and frequency accuracy and minimizes the affects of antenna pulling. Housed in a tiny reflow-compatible SMD package, the transmitter requires no external RF components except an antenna, which greatly simplifies integration and lowers assembly costs.

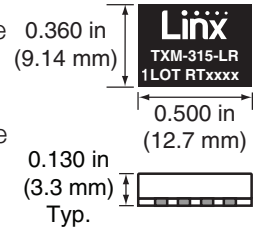

Figure 1: Package Dimensions

Features

- Long range
- Low cost
- PLL-synthesized architecture
- Direct serial interface
- Data rates up to 10,000bps
- No external RF components required
- Low power consumption
- Low supply voltage (2.1 to 3.6VDC)
- Compact surface-mount package
- Wide temperature range
- Power-down function
- No production tuning

Applications

- Remote control
- Keyless entry
- Garage/gate openers
- Lighting control
- Medical monitoring/call systems
- Remote industrial monitoring
- Periodic data transfer
- Home/industrial automation
- Fire/security alarms
- Remote status/position sensing
- Long-range RFID
- Wire elimination

Ordering Information

Ordering Information	
Part Number	Description
TXM-315-LR	315MHz Transmitter
TXM-418-LR	418MHz Transmitter
TXM-433-LR	433MHz Transmitter
RXM-315-LR	315MHz Receiver
RXM-418-LR	418MHz Receiver
RXM-433-LR	433MHz Receiver
EVAL-***-LR	LR Series Basic Evaluation Kit

*** = 315, 418 (Standard), 433MHz
Transmitters are supplied in tubes of 50 pcs.

Figure 2: Ordering Information

Absolute Maximum Ratings

Absolute Maximum Ratings				
Supply Voltage V_{CC}	-0.3	to	+3.6	VDC
Any Input or Output Pin	-0.3	to	$V_{CC} + 0.3$	VDC
Operating Temperature	-40	to	+85	°C
Storage Temperature	-40	to	+90	°C
Soldering Temperature	+260°C for 10 seconds			

Exceeding any of the limits of this section may lead to permanent damage to the device. Furthermore, extended operation at these maximum ratings may reduce the life of this device.

Figure 3: Absolute Maximum Ratings



Warning: This product incorporates numerous static-sensitive components. Always wear an ESD wrist strap and observe proper ESD handling procedures when working with this device. Failure to observe this precaution may result in module damage or failure.

Electrical Specifications

LR Series Transmitter Specifications						
Parameter	Symbol	Min.	Typ.	Max.	Units	Notes
Power Supply						
Operating Voltage	V_{CC}	2.1	3.0	3.6	VDC	
Supply Current	I_{CC}		3.4		mA	1,2
Logic High			5.1		mA	2
Logic Low			1.8		mA	
Power Down Current	I_{PDN}		5.0		nA	
Transmitter Section						
Transmit Frequency Range	F_C					
TXM-315-LR			315		MHz	
TXM-418-LR			418		MHz	
TXM-433-LR			433.92		MHz	
Center Frequency Accuracy		-50		+50	kHz	
Output Power	P_O	-4	0.0	+4	dBm	2
Output Power Control Range		-80		+10	dB	3
Harmonic Emissions	P_H			-36	dBc	
Data Rate		DC		10,000	bps	
Data Input:						
Logic Low	V_{IL}			0.25	VDC	
Logic High	V_{IH}	$V_{CC}-0.25$			VDC	
Power Down Input:						
Logic Low	V_{IL}			0.25	VDC	
Logic High	V_{IH}	$V_{CC}-0.25$			VDC	
Antenna Port						
RF Output Impedance	R_{OUT}		50		Ω	4
Timing						
Transmitter Turn-On Time						
Via V_{CC} or PDN			1.0		ms	4
Modulation Delay				30.0	ns	4
Environmental						
Operating Temperature		-40		+85	°C	4

- With a 50% duty cycle
- With a 750 Ω resistor on LADJ
- See Figure 6 on page 4
- Characterized, but not tested

Figure 4: Electrical Specifications

Typical Performance Graphs

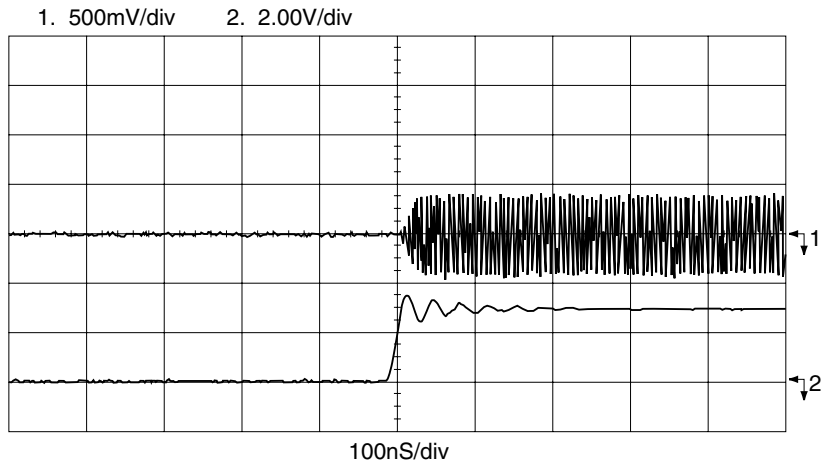

Figure 5: Modulation Delay

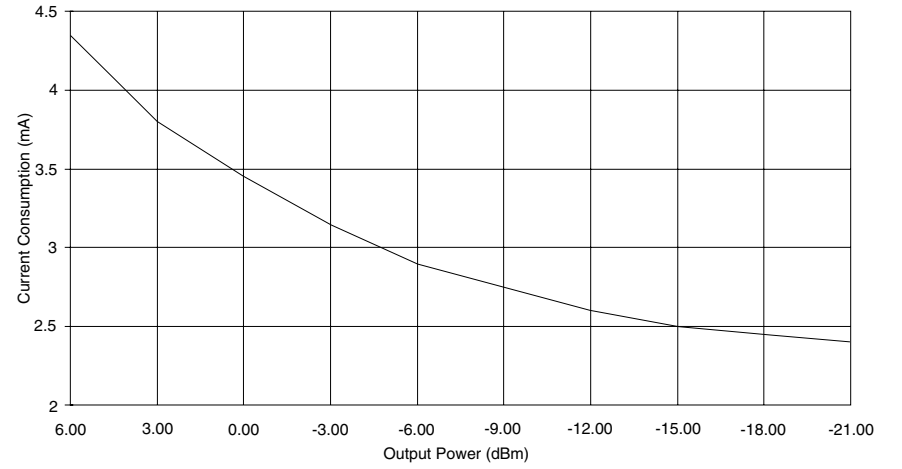

Figure 7: Current Consumption vs. Output Power (50% of Duty Cycle)

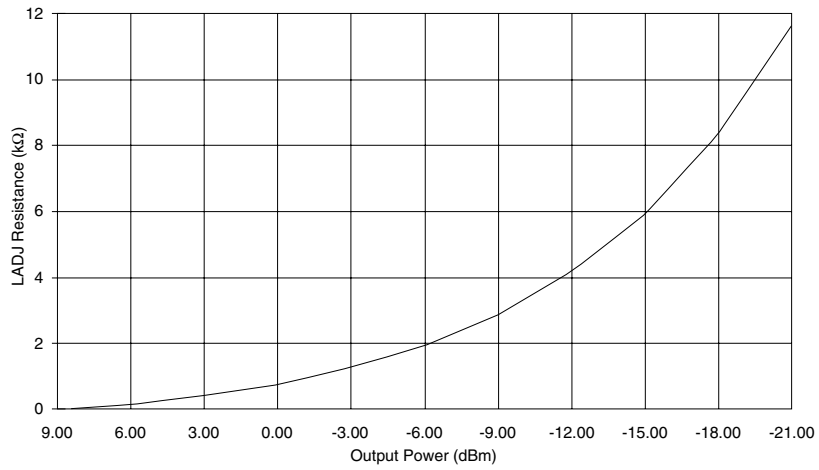

Figure 6: Output Power vs. LADJ Resistor

Pin Assignments

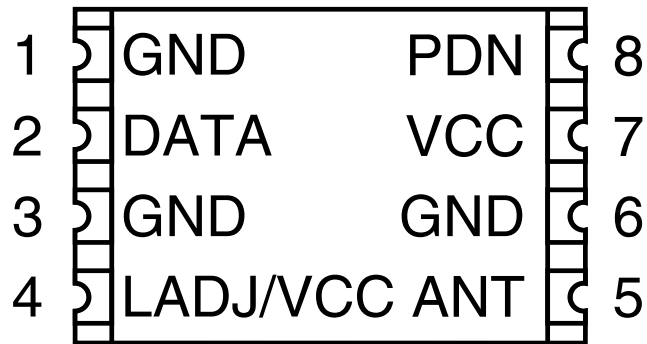

Figure 8: LR Series Transmitter Pinout (Top View)

Pin Descriptions

Pin Descriptions			
Pin Number	Name	I/O	Description
1	GND	—	Analog Ground
2	DATA	I	Digital Data Input
3	GND	—	Analog Ground
4	LADJ/V _{CC}	I	Level Adjust. This line can be used to adjust the output power level of the transmitter. Connecting to V _{CC} gives the highest output, while placing a resistor to V _{CC} lowers the output level (see Figure 6 on page 4)
5	ANT	—	50Ω RF Output
6	GND	—	Analog Ground
7	V _{CC}	—	Supply Voltage
8	PDN	I	Power Down. Pulling this line low places the transmitter into a low-current state. The module is not able to transmit a signal in this state.

Figure 9: Pin Descriptions

Module Description

The LR Series transmitter is a low-cost, high-performance synthesized ASK / OOK transmitter, capable of sending serial data at up to 10,000bps. Because the transmitter is completely self-contained, requiring an antenna as the only additional RF component, application is extremely straightforward and assembly and testing costs are reduced. The LR is housed in a compact surface-mount package that integrates easily into existing designs and is equally friendly to prototyping and volume production. LR Series modules are capable of meeting the regulatory requirements of domestic and international applications.

The module's low power consumption makes it ideal for battery-powered products. The transmitter is compatible with many other Linx receiver products, including the LR, KH3, LT and OEM product families. For applications where range is critical, the LR receiver is the best choice due to its outstanding sensitivity.

The transmitter is capable of outputting +10dBm into a 50-ohm load. When combined with an LR Series receiver, a reliable serial link is formed capable of transferring data over line-of-site distances of up to 1.5 miles (2,500m) when used with good antennas. Legal regulations in the various countries will require the transmitter output power to be reduced which will reduce range. Following the legal output limit for transmitters in the United States, systems based on the LR Series can achieve ranges of up to 3,000 feet (1,000m).

Theory of Operation

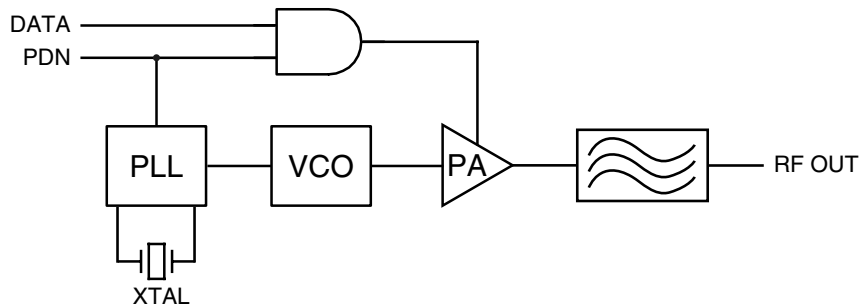

Figure 10: LR Series Transmitter Block Diagram

The LR Series transmitter generates 1mW of output power into a 50-ohm single-ended antenna while suppressing harmonics and spurious emissions to within legal limits. The transmitter is comprised of a VCO locked by a frequency synthesizer that is referenced to a high precision crystal. The output of the VCO is amplified and buffered by an internal power amplifier. The amplifier is switched by the incoming data to produce a modulated carrier. The carrier is filtered to attenuate harmonics and then output on the 50Ω antenna port.

The synthesized topology makes the module highly immune to the effects of antenna port loading and mismatch. This reduces or eliminates frequency pulling, bit contraction, and other negative effects common to low-cost transmitter architectures. It also allows for reliable performance over a wide operating temperature range. Like its companion LR Series receiver, the LR Series transmitter delivers a significantly higher level of performance and reliability than the LC Series or other SAW-based devices, yet remains very small and cost-effective.

The Data Input

The CMOS-compatible data input on Pin 2 is normally supplied with a serial bit stream from a microprocessor or encoder, but it can also be used with standard UARTs.

When a logic '1' is present on the DATA line and the PDN line is high, then the Power Amplifier (PA) is activated and the carrier frequency is output on the antenna port. When a logic '0' is present on the DATA line or the PDN line is low, the PA is deactivated and the carrier is fully suppressed.

The DATA line should always be driven with a voltage that is common to the supply voltage present on Pin 7 (V_{CC}). The DATA line should never be allowed to exceed the supply voltage, as permanent damage to the module could occur.

Using the PDN Line

The transmitter's Power Down (PDN) line can be used to power down the transmitter without the need for an external switch. It allows easy control of the transmitter's state from external components, such as a microcontroller. By periodically activating the transmitter, sending data, then powering down, the transmitter's average current consumption can be greatly reduced, saving power in battery operated applications.

The PDN line does not have an internal pull-up, so it needs to be pulled high or tied directly to V_{CC} to turn on the transmitter. The pull-up should be a minimum of 30μA (10kΩ or less). When the PDN line is pulled to ground, the transmitter enters a low-current (<5nA) power-down mode. In this mode, the transmitter is completely off and cannot perform any function.

Note: The voltage on the PDN line should not exceed V_{CC} . When used with a higher voltage source, such as a 5V microcontroller, an open collector line should be used or a diode placed in series with the control line (anode toward the module). Either method avoids damage to the module by preventing 5V from being placed on the PDN line while allowing the line to be pulled low.

Using the LADJ Line

The Level Adjust (LADJ) line allows the transmitter's output power to be easily adjusted for range control, lower power consumption, or to meet legal requirements. This is done by placing a resistor between V_{CC} and LADJ. The value of the resistor determines the output power level. When LADJ is connected to V_{CC} , the output power and current consumption are at the maximum. Figure 6 on page 4 shows a graph of the output power vs. LADJ resistance.

This line is very useful during FCC testing to compensate for antenna gain or other product-specific issues that may cause the output power to exceed legal limits. A variable resistor can be temporarily used so that the test lab can precisely adjust the output power to the maximum level allowed by law. The variable resistor's value can be noted and a fixed resistor substituted for final testing. Even in designs where attenuation is not anticipated, it is a good idea to place a resistor pad connected to LADJ and V_{CC} so that it can be used if needed. For more sophisticated designs, LADJ can be also controlled by a digital potentiometer to allow precise and digitally variable output power control.

Power Supply Requirements

The module does not have an internal voltage regulator; therefore it requires a clean, well-regulated power source. While it is preferable to power the unit from a battery, it can also be operated from a power supply as long as noise is less than 20mV. Power supply noise can affect the transmitter modulation; therefore, providing a clean power supply for the module should be a high priority during design.

A 10Ω resistor in series with the supply followed by a $10\mu\text{F}$ tantalum capacitor from V_{CC} to ground will help in cases where the quality of the supply is poor. Note that the values may need to be adjusted depending on the noise present on the supply line.

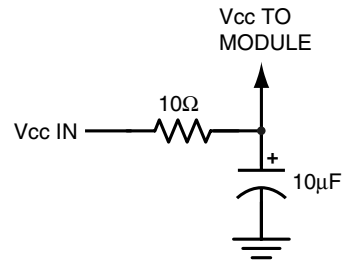

Figure 11: Supply Filter

Transferring Data

Once a reliable RF link has been established, the challenge becomes how to effectively transfer data across it. While a properly designed RF link provides reliable data transfer under most conditions, there are still distinct differences from a wired link that must be addressed. Since the LR Series modules do not incorporate internal encoding or decoding, a user has tremendous flexibility in how data is handled.

If the product transfers simple control or status signals such as button presses or switch closures and it does not have a microprocessor on board (or it is desired to avoid protocol development), consider using a remote control encoder and decoder or a transcoder IC. These chips are available from a wide range of manufacturers including Linx. They take care of all encoding and decoding functions, and generally provide a number of data pins to which switches can be directly connected. In addition, address bits are usually provided for security and to allow the addressing of multiple units independently. These ICs are an excellent way to bring basic remote control / status products to market quickly and inexpensively. Additionally, it is a simple task to interface with inexpensive microprocessors, IR, remote control or modem ICs.

It is always important to separate the types of transmissions that are technically possible from those that are legally allowable in the country of intended operation. Linx Application Notes AN-00125, AN-00128 and AN-00140 should be reviewed, along with Part 15, Section 231 of the Code of Federal Regulations for further details regarding acceptable transmission content in the US. All of these documents can be downloaded from the Linx website at www.linxtechnologies.com.

Another area of consideration is that the data structure can affect the output power level. The FCC allows output power in the 260 to 470MHz band to be averaged over a 100ms time frame. Because OOK modulation activates the carrier for a '1' and deactivates the carrier for a '0', a data stream that sends more '0's has a lower average output power over 100ms. This allows the instantaneous output power to be increased, thus extending range.

Typical Applications

Figure 12 shows a circuit using a Linx MS Series encoder. This chip works with the LICAL-DEC-MS001 decoder to provide simple remote control capabilities. The decoder detects the transmission from the encoder, checks for errors, and if everything is correct, replicates the encoder's inputs on its outputs. This makes registering key presses very simple.

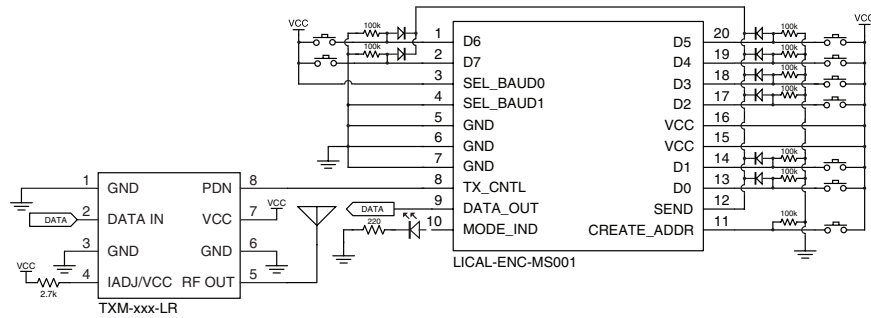

Figure 12: LR Transmitter and MS Encoder

The transmitter can also be connected to a GPIO of a microcontroller in applications that use a custom protocol. No buffering is generally required between the transmitter and microcontroller output. Exceptions to this include systems where the microcontroller is operating at a different voltage from the transmitter. In these cases the designer should take care to use voltage translator circuits as appropriate.

ESD Concerns

The module has basic ESD protection built in, but in cases where the antenna connection is exposed to the user it is a good idea to add additional protection. A Transient Voltage Suppressor (TVS) diode, varistor or similar component can be added to the antenna line. These should have low capacitance and be designed for use on antennas. Protection on the supply line is a good idea in designs that have a user-accessible power port.

Antenna Considerations

The choice of antennas is a critical and often overlooked design consideration. The range, performance and legality of an RF link are critically dependent upon the antenna. While adequate antenna performance can often be obtained by trial and error methods, antenna design and matching is a complex



Figure 13: Linx Antennas

task. Professionally designed antennas such as those from Linx (Figure 13) help ensure maximum performance and FCC and other regulatory compliance.

Linx transmitter modules typically have an output power that is higher than the legal limits. This allows the designer to use an inefficient antenna such as a loop trace or helical to meet size, cost or cosmetic requirements and still achieve full legal output power for maximum range. If an efficient antenna is used, then some attenuation of the output power will likely be needed. This can easily be accomplished by using the LADJ line.

A receiver antenna should be optimized for the frequency or band in which the receiver operates and to minimize the reception of off-frequency signals. The efficiency of the receiver's antenna is critical to maximizing range performance. Unlike the transmitter antenna, where legal operation may mandate attenuation or a reduction in antenna efficiency, the receiver's antenna should be optimized as much as is practical.

It is usually best to utilize a basic quarter-wave whip until your prototype product is operating satisfactorily. Other antennas can then be evaluated based on the cost, size and cosmetic requirements of the product. Additional details are in Application Note AN-00500.

Helpful Application Notes from Linx

It is not the intention of this manual to address in depth many of the issues that should be considered to ensure that the modules function correctly and deliver the maximum possible performance. We recommend reading the application notes listed in Figure 14 which address in depth key areas of RF design and application of Linx products. These applications notes are available online at www.linxtechnologies.com or by contacting Linx.

Helpful Application Note Titles	
Note Number	Note Title
AN-00100	RF 101: Information for the RF Challenged
AN-00125	Considerations for Operation Within the 260–470MHz Band
AN-00130	Modulation Techniques for Low-Cost RF Data Links
AN-00140	The FCC Road: Part 15 from Concept to Approval
AN-00150	Use and Design of T-Attenuation Pads
AN-00160	Considerations for Sending Data over a Wireless Link
AN-00232	General Considerations for Sending Data with the LC Series
AN-00500	Antennas: Design, Application, Performance
AN-00501	Understanding Antenna Specifications and Operation

Figure 14: Helpful Application Note Titles

Protocol Guidelines

While many RF solutions impose data formatting and balancing requirements, Linx RF modules do not encode or packetize the signal content in any manner. The received signal will be affected by such factors as noise, edge jitter and interference, but it is not purposefully manipulated or altered by the modules. This gives the designer tremendous flexibility for protocol design and interface.

Despite this transparency and ease of use, it must be recognized that there are distinct differences between a wired and a wireless environment. Issues such as interference and contention must be understood and allowed for in the design process. To learn more about protocol considerations, read Linx Application Note AN-00160.

Interference or changing signal conditions can corrupt the data packet, so it is generally wise to structure the data being sent into small packets. This allows errors to be managed without affecting large amounts of data. A simple checksum or CRC could be used for basic error detection. Once an error is detected, the protocol designer may wish to simply discard the corrupt data or implement a more sophisticated scheme to correct it.

Interference Considerations

The RF spectrum is crowded and the potential for conflict with unwanted sources of RF is very real. While all RF products are at risk from interference, its effects can be minimized by better understanding its characteristics.

Interference may come from internal or external sources. The first step is to eliminate interference from noise sources on the board. This means paying careful attention to layout, grounding, filtering and bypassing in order to eliminate all radiated and conducted interference paths. For many products, this is straightforward; however, products containing components such as switching power supplies, motors, crystals and other potential sources of noise must be approached with care. Comparing your own design with a Linx evaluation board can help to determine if and at what level design-specific interference is present.

External interference can manifest itself in a variety of ways. Low-level interference produces noise and hashing on the output and reduces the link's overall range.

High-level interference is caused by nearby products sharing the same frequency or from near-band high-power devices. It can even come from your own products if more than one transmitter is active in the same area. It is important to remember that only one transmitter at a time can occupy a frequency, regardless of the coding of the transmitted signal. This type of interference is less common than those mentioned previously, but in severe cases it can prevent all useful function of the affected device.

Although technically not interference, multipath is also a factor to be understood. Multipath is a term used to refer to the signal cancellation effects that occur when RF waves arrive at the receiver in different phase relationships. This effect is a particularly significant factor in interior environments where objects provide many different signal reflection paths. Multipath cancellation results in lowered signal levels at the receiver and shorter useful distances for the link.

Pad Layout

The pad layout diagram in Figure 15 is designed to facilitate both hand and automated assembly.

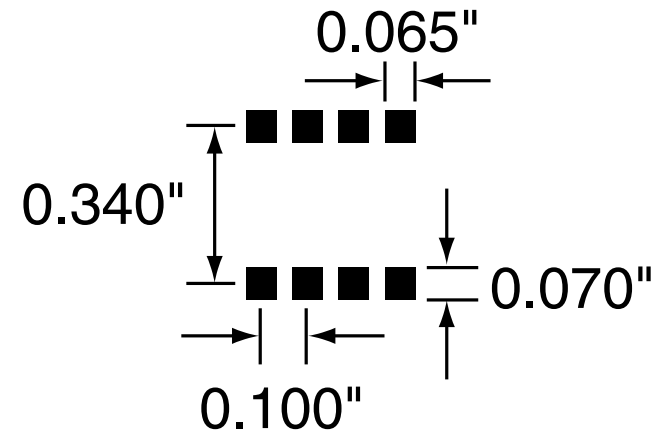

Figure 15: Recommended PCB Layout

Board Layout Guidelines

The module's design makes integration straightforward; however, it is still critical to exercise care in PCB layout. Failure to observe good layout techniques can result in a significant degradation of the module's performance. A primary layout goal is to maintain a characteristic 50-ohm impedance throughout the path from the antenna to the module. Grounding, filtering, decoupling, routing and PCB stack-up are also important considerations for any RF design. The following section provides some basic design guidelines.

During prototyping, the module should be soldered to a properly laid-out circuit board. The use of prototyping or "perf" boards results in poor performance and is strongly discouraged. Likewise, the use of sockets can have a negative impact on the performance of the module and is discouraged.

The module should, as much as reasonably possible, be isolated from other components on your PCB, especially high-frequency circuitry such as crystal oscillators, switching power supplies, and high-speed bus lines.

When possible, separate RF and digital circuits into different PCB regions.

Make sure internal wiring is routed away from the module and antenna and is secured to prevent displacement.

Do not route PCB traces directly under the module. There should not be any copper or traces under the module on the same layer as the module, just bare PCB. The underside of the module has traces and vias that could short or couple to traces on the product's circuit board.

The Pad Layout section shows a typical PCB footprint for the module. A ground plane (as large and uninterrupted as possible) should be placed on a lower layer of your PCB opposite the module. This plane is essential for creating a low impedance return for ground and consistent stripline performance.

Use care in routing the RF trace between the module and the antenna or connector. Keep the trace as short as possible. Do not pass it under the module or any other component. Do not route the antenna trace on multiple PCB layers as vias add inductance. Vias are acceptable for tying together ground layers and component grounds and should be used in multiples.

Each of the module's ground pins should have short traces tying immediately to the ground plane through a via.

Bypass caps should be low ESR ceramic types and located directly adjacent to the pin they are serving.

A 50-ohm coax should be used for connection to an external antenna. A 50-ohm transmission line, such as a microstrip, stripline or coplanar waveguide should be used for routing RF on the PCB. The Microstrip Details section provides additional information.

In some instances, a designer may wish to encapsulate or "pot" the product. There are a wide variety of potting compounds with varying dielectric properties. Since such compounds can considerably impact RF performance and the ability to rework or service the product, it is the responsibility of the designer to evaluate and qualify the impact and suitability of such materials.

Microstrip Details

A transmission line is a medium whereby RF energy is transferred from one place to another with minimal loss. This is a critical factor, especially in high-frequency products like Linx RF modules, because the trace leading to the module's antenna can effectively contribute to the length of the antenna, changing its resonant bandwidth. In order to minimize loss and detuning, some form of transmission line between the antenna and the module should be used unless the antenna can be placed very close (<1/8in) to the module. One common form of transmission line is a coax cable and another is the microstrip. This term refers to a PCB trace running over a ground plane that is designed to serve as a transmission line between the module and the antenna. The width is based on the desired characteristic impedance of the line, the thickness of the PCB and the dielectric constant of the board material. For standard 0.062in thick FR-4 board material, the trace width would be 111 mils. The correct trace width can be calculated for other widths and materials using the information in Figure 16 and examples are provided in Figure 17. Software for calculating microstrip lines is also available on the Linx website.

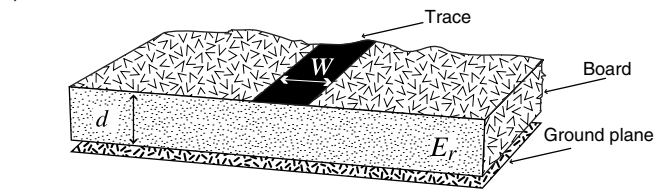

$$E_e = \frac{E_r+1}{2} + \frac{E_r-1}{2} \cdot \frac{1}{\sqrt{1+12d/W}}$$

$$Z_0 = \begin{cases} \frac{60}{\sqrt{E_e}} \cdot \ln\left(\frac{8d}{W} + \frac{W}{4d}\right) & \text{For } \frac{W}{d} \leq 1 \\ \frac{120\pi}{\sqrt{E_e} \cdot \left(\frac{W}{d} + 1.393 + 0.667 \cdot \ln\left(\frac{W}{d} + 1.444\right)\right)} & \text{For } \frac{W}{d} \geq 1 \end{cases}$$

E_r = Dielectric constant of PCB material

Figure 16: Microstrip Formulas

Example Microstrip Calculations			
Dielectric Constant	Width / Height Ratio (W / d)	Effective Dielectric Constant	Characteristic Impedance (Ω)
4.80	1.8	3.59	50.0
4.00	2.0	3.07	51.0
2.55	3.0	2.12	48.8

Figure 17: Example Microstrip Calculations

Production Guidelines

The module is housed in a hybrid SMD package that supports hand and automated assembly techniques. Since the modules contain discrete components internally, the assembly procedures are critical to ensuring the reliable function of the modules. The following procedures should be reviewed with and practiced by all assembly personnel.

Hand Assembly

Pads located on the bottom of the module are the primary mounting surface (Figure 18). Since these pads are inaccessible during mounting, castellations that run up the side of the module have been provided to facilitate solder wicking to the module's underside. This allows for very

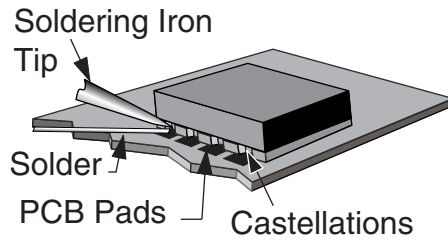

Figure 18: Soldering Technique

quick hand soldering for prototyping and small volume production. If the recommended pad guidelines have been followed, the pads will protrude slightly past the edge of the module. Use a fine soldering tip to heat the board pad and the castellation, then introduce solder to the pad at the module's edge. The solder will wick underneath the module, providing reliable attachment. Tack one module corner first and then work around the device, taking care not to exceed the times in Figure 19.

Warning: Pay attention to the absolute maximum solder times.

Absolute Maximum Solder Times

Hand Solder Temperature: +427°C for 10 seconds for lead-free alloys

Reflow Oven: +255°C max (see Figure 20)

Figure 19: Absolute Maximum Solder Times

Automated Assembly

For high-volume assembly, the modules are generally auto-placed. The modules have been designed to maintain compatibility with reflow processing techniques; however, due to their hybrid nature, certain aspects of the assembly process are far more critical than for other component types. Following are brief discussions of the three primary areas where caution must be observed.

Reflow Temperature Profile

The single most critical stage in the automated assembly process is the reflow stage. The reflow profile in Figure 20 should not be exceeded because excessive temperatures or transport times during reflow will irreparably damage the modules. Assembly personnel need to pay careful attention to the oven's profile to ensure that it meets the requirements necessary to successfully reflow all components while still remaining within the limits mandated by the modules. The figure below shows the recommended reflow oven profile for the modules.

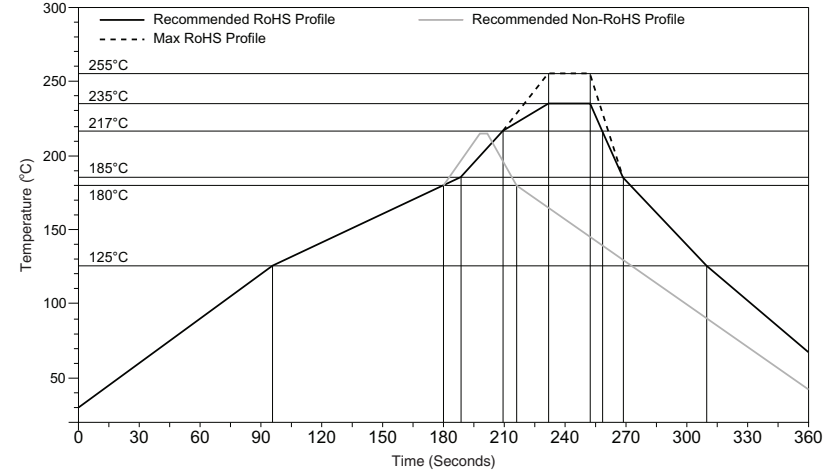

Figure 20: Maximum Reflow Temperature Profile

Shock During Reflow Transport

Since some internal module components may reflow along with the components placed on the board being assembled, it is imperative that the modules not be subjected to shock or vibration during the time solder is liquid. Should a shock be applied, some internal components could be lifted from their pads, causing the module to not function properly.

Washability

The modules are wash-resistant, but are not hermetically sealed. Linx recommends wash-free manufacturing; however, the modules can be subjected to a wash cycle provided that a drying time is allowed prior to applying electrical power to the modules. The drying time should be sufficient to allow any moisture that may have migrated into the module to evaporate, thus eliminating the potential for shorting damage during power-up or testing. If the wash contains contaminants, the performance may be adversely affected, even after drying.

General Antenna Rules

The following general rules should help in maximizing antenna performance.

1. Proximity to objects such as a user's hand, body or metal objects will cause an antenna to detune. For this reason, the antenna shaft and tip should be positioned as far away from such objects as possible.
2. Optimum performance is obtained from a $\frac{1}{4}$ - or $\frac{1}{2}$ -wave straight whip mounted at a right angle to the ground plane (Figure 21). In many cases, this isn't desirable for practical or ergonomic reasons, thus, an alternative antenna style such as a helical, loop or patch may be utilized and the corresponding sacrifice in performance accepted.



Figure 21: Ground Plane Orientation

3. If an internal antenna is to be used, keep it away from other metal components, particularly large items like transformers, batteries, PCB tracks and ground planes. In many cases, the space around the antenna is as important as the antenna itself. Objects in close proximity to the antenna can cause direct detuning, while those farther away will alter the antenna's symmetry.
4. In many antenna designs, particularly $\frac{1}{4}$ -wave whips, the ground plane acts as a counterpoise, forming, in essence, a $\frac{1}{2}$ -wave dipole (Figure 22). For this reason, adequate ground plane area is essential. The ground plane can be a metal case or ground-fill areas on a circuit board. Ideally, it should have a surface area less than or equal to the overall length of the $\frac{1}{4}$ -wave radiating element. This is often not practical due to size and configuration constraints. In these instances, a designer must make the best use of the area available to create as much ground

VERTICAL $\lambda/4$ GROUNDED ANTENNA (MARCONI)

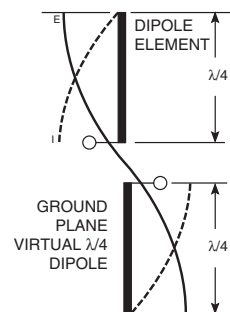

Figure 22: Dipole Antenna

plane as possible in proximity to the base of the antenna. In cases where the antenna is remotely located or the antenna is not in close proximity to a circuit board, ground plane or grounded metal case, a metal plate may be used to maximize the antenna's performance.

5. Remove the antenna as far as possible from potential interference sources. Any frequency of sufficient amplitude to enter the receiver's front end will reduce system range and can even prevent reception entirely. Switching power supplies, oscillators or even relays can also be significant sources of potential interference. The single best weapon against such problems is attention to placement and layout. Filter the module's power supply with a high-frequency bypass capacitor. Place adequate ground plane under potential sources of noise to shunt noise to ground and prevent it from coupling to the RF stage. Shield noisy board areas whenever practical.
6. In some applications, it is advantageous to place the module and antenna away from the main equipment (Figure 23). This can avoid interference problems and allows the antenna to be oriented for optimum performance. Always use 50Ω coax, like RG-174, for the remote feed.

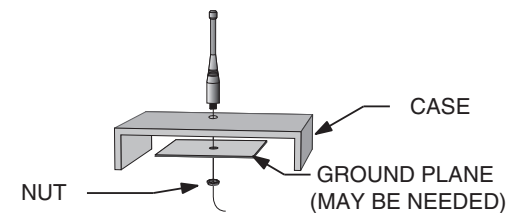

Figure 23: Remote Ground Plane

Common Antenna Styles

There are hundreds of antenna styles and variations that can be employed with Linx RF modules. Following is a brief discussion of the styles most commonly utilized. Additional antenna information can be found in Linx Application Notes AN-00100, AN-00140, AN-00500 and AN-00501. Linx antennas and connectors offer outstanding performance at a low price.

Whip Style

A whip style antenna (Figure 24) provides outstanding overall performance and stability. A low-cost whip can be easily fabricated from a wire or rod, but most designers opt for the consistent performance and cosmetic appeal of a professionally-made model. To meet this need, Linx offers a wide variety of straight and reduced height whip style antennas in permanent and connectorized mounting styles.



Figure 24: Whip Style Antennas

The wavelength of the operational frequency determines an antenna's overall length. Since a full wavelength is often quite long, a partial 1/2- or 1/4-wave antenna is normally employed. Its size and natural radiation resistance make it well matched to Linx modules. The proper length for a straight 1/4-wave can be easily determined using the formula in Figure 25.

$$L = \frac{234}{F_{\text{MHz}}}$$

Figure 25:
L = length in feet of quarter-wave length
F = operating frequency in megahertz

It is also possible to reduce the overall height of the antenna by using a helical winding. This reduces the antenna's bandwidth but is a great way to minimize the antenna's physical size for compact applications. This also means that the physical appearance is not always an indicator of the antenna's frequency.

Specialty Styles

Linx offers a wide variety of specialized antenna styles (Figure 26). Many of these styles utilize helical elements to reduce the overall antenna size while maintaining reasonable performance. A helical antenna's bandwidth is often quite narrow and the antenna can detune in proximity to other objects, so care must be exercised in layout and placement.



Figure 26: Specialty Style Antennas

Loop Style

A loop or trace style antenna is normally printed directly on a product's PCB (Figure 27). This makes it the most cost-effective of antenna styles. The element can be made self-resonant or externally resonated with discrete components, but its actual layout is usually product specific. Despite the cost advantages, loop style antennas are generally inefficient and useful only for short range applications. They are also very sensitive to changes in layout and PCB dielectric, which can cause consistency issues during production. In addition, printed styles are difficult to engineer, requiring the use of expensive equipment including a network analyzer. An improperly designed loop will have a high VSWR at the desired frequency which can cause instability in the RF stage.



Figure 27: Loop or Trace Antenna

Linx offers low-cost planar (Figure 28) and chip antennas that mount directly to a product's PCB. These tiny antennas do not require testing and provide excellent performance despite their small size. They offer a preferable alternative to the often problematic "printed" antenna.



Figure 28: SP Series "Splatch" and uSP "MicroSplatch" Antennas

Regulatory Considerations

Note: Linx RF modules are designed as component devices that require external components to function. The purchaser understands that additional approvals may be required prior to the sale or operation of the device, and agrees to utilize the component in keeping with all laws governing its use in the country of operation.

When working with RF, a clear distinction must be made between what is technically possible and what is legally acceptable in the country where operation is intended. Many manufacturers have avoided incorporating RF into their products as a result of uncertainty and even fear of the approval and certification process. Here at Linx, our desire is not only to expedite the design process, but also to assist you in achieving a clear idea of what is involved in obtaining the necessary approvals to legally market a completed product.

For information about regulatory approval, read AN-00142 on the Linx website or call Linx. Linx designs products with worldwide regulatory approval in mind.

In the United States, the approval process is actually quite straightforward. The regulations governing RF devices and the enforcement of them are the responsibility of the Federal Communications Commission (FCC). The regulations are contained in Title 47 of the United States Code of Federal Regulations (CFR). Title 47 is made up of numerous volumes; however, all regulations applicable to this module are contained in Volume 0-19. It is strongly recommended that a copy be obtained from the FCC's website, the Government Printing Office in Washington or from your local government bookstore. Excerpts of applicable sections are included with Linx evaluation kits or may be obtained from the Linx Technologies website, www.linxtechnologies.com. In brief, these rules require that any device that intentionally radiates RF energy be approved, that is, tested for compliance and issued a unique identification number. This is a relatively painless process. Final compliance testing is performed by one of the many independent testing laboratories across the country. Many labs can also provide other certifications that the product may require at the same time, such as UL, CLASS A / B, etc. Once the completed product has passed, an ID number is issued that is to be clearly placed on each product manufactured.

Questions regarding interpretations of the Part 2 and Part 15 rules or the measurement procedures used to test intentional radiators such as Linx RF modules for compliance with the technical standards of Part 15 should be addressed to:

Federal Communications Commission
Equipment Authorization Division
Customer Service Branch, MS 1300F2
7435 Oakland Mills Road
Columbia, MD, US 21046
Phone: + 1 301 725 585 | Fax: + 1 301 344 2050
Email: labinfo@fcc.gov

ETSI Secretaria
650, Route des Lucioles
06921 Sophia-Antipolis Cedex
FRANCE
Phone: +33 (0)4 92 94 42 00
Fax: +33 (0)4 93 65 47 16

International approvals are slightly more complex, although Linx modules are designed to allow all international standards to be met. If the end product is to be exported to other countries, contact Linx to determine the specific suitability of the module to the application.

All Linx modules are designed with the approval process in mind and thus much of the frustration that is typically experienced with a discrete design is eliminated. Approval is still dependent on many factors, such as the choice of antennas, correct use of the frequency selected and physical packaging. While some extra cost and design effort are required to address these issues, the additional usefulness and profitability added to a product by RF makes the effort more than worthwhile.



Linx Technologies
159 Ort Lane
Merlin, OR, US 97532

Phone: +1 541 471 6256
Fax: +1 541 471 6251

www.linxtechnologies.com

Disclaimer

Linx Technologies is continually striving to improve the quality and function of its products. For this reason, we reserve the right to make changes to our products without notice. The information contained in this Data Guide is believed to be accurate as of the time of publication. Specifications are based on representative lot samples. Values may vary from lot-to-lot and are not guaranteed. "Typical" parameters can and do vary over lots and application. Linx Technologies makes no guarantee, warranty, or representation regarding the suitability of any product for use in any specific application. It is the customer's responsibility to verify the suitability of the part for the intended application. **NO LINX PRODUCT IS INTENDED FOR USE IN ANY APPLICATION WHERE THE SAFETY OF LIFE OR PROPERTY IS AT RISK.**

Linx Technologies **DISCLAIMS ALL WARRANTIES OF MERCHANTABILITY AND FITNESS FOR A PARTICULAR PURPOSE. IN NO EVENT SHALL LINX TECHNOLOGIES BE LIABLE FOR ANY OF CUSTOMER'S INCIDENTAL OR CONSEQUENTIAL DAMAGES ARISING IN ANY WAY FROM ANY DEFECTIVE OR NON-CONFORMING PRODUCTS OR FOR ANY OTHER BREACH OF CONTRACT BY LINX TECHNOLOGIES.** The limitations on Linx Technologies' liability are applicable to any and all claims or theories of recovery asserted by Customer, including, without limitation, breach of contract, breach of warranty, strict liability, or negligence. Customer assumes all liability (including, without limitation, liability for injury to person or property, economic loss, or business interruption) for all claims, including claims from third parties, arising from the use of the Products. The Customer will indemnify, defend, protect, and hold harmless Linx Technologies and its officers, employees, subsidiaries, affiliates, distributors, and representatives from and against all claims, damages, actions, suits, proceedings, demands, assessments, adjustments, costs, and expenses incurred by Linx Technologies as a result of or arising from any Products sold by Linx Technologies to Customer. Under no conditions will Linx Technologies be responsible for losses arising from the use or failure of the device in any application, other than the repair, replacement, or refund limited to the original product purchase price. Devices described in this publication may contain proprietary, patented, or copyrighted techniques, components, or materials. Under no circumstances shall any user be conveyed any license or right to the use or ownership of such items.

©2015 Linx Technologies. All rights reserved.

The stylized Linx logo, Wireless Made Simple, WISE, CipherLinx and the stylized CL logo are trademarks of Linx Technologies.