

RITA-A

Asymmetric beam. Assembly with installation tape

TECHNICAL SPECIFICATIONS:

Dimensions	36.0 x 28.4 mm
Height	17.3 mm
Fastening	tape, pin
ROHS compliant	yes ⓘ

MATERIAL SPECIFICATIONS:

Component	Type	Material	Colour	Finish
RITA-A	Reflector	HRPC	white	
HEIDI-TAPE	Tape	PU tape	black	



ORDERING INFORMATION:

Component		Qty in box	MOQ	MPQ	Box weight (kg)
CA12514_RITA-A	Reflector	810		54	4.3
» Box size:					

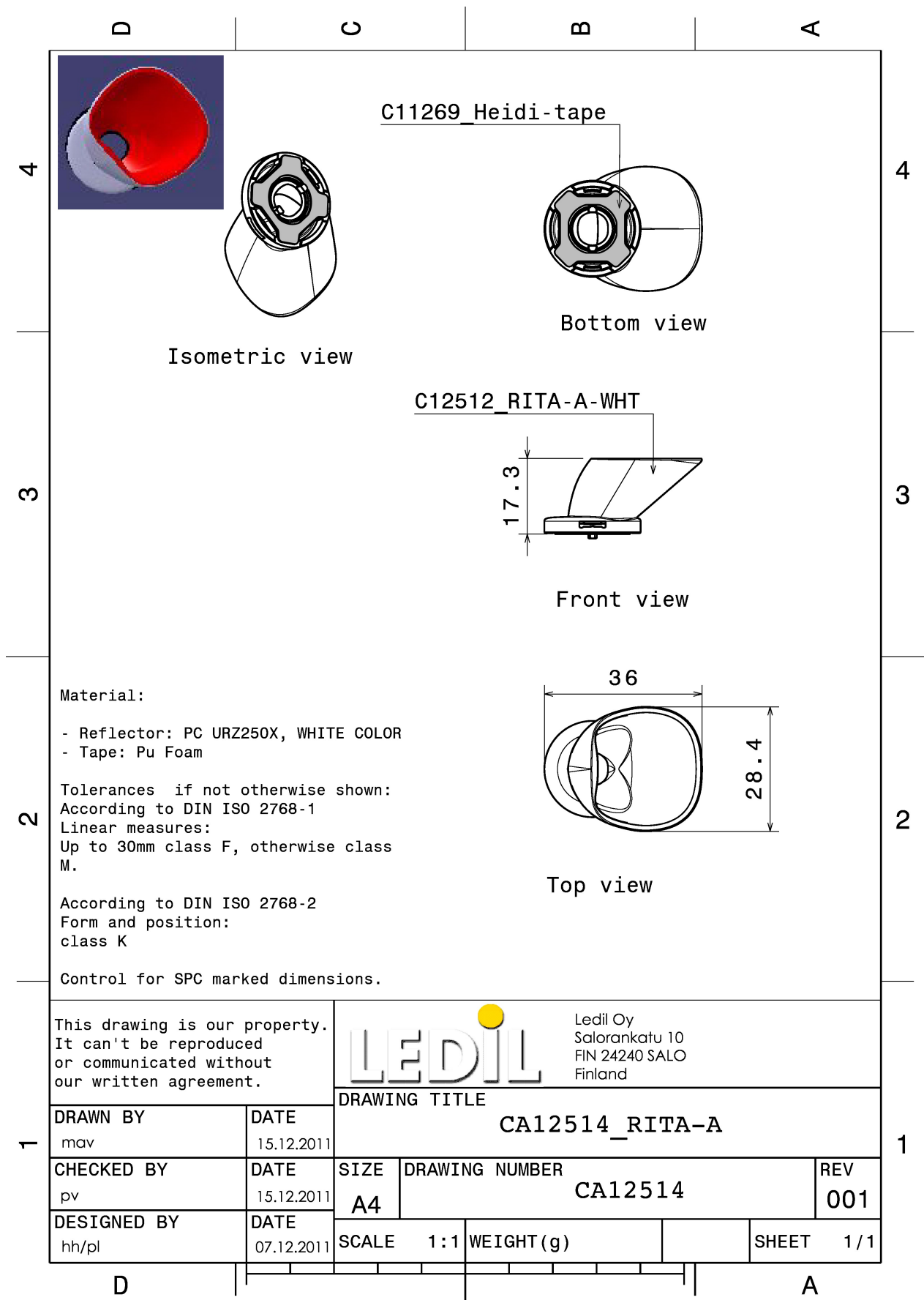

This drawing is our property. It can't be reproduced or communicated without our written agreement.		 Ledil Oy Salorankatu 10 FIN 24240 SALO Finland	
DRAWING TITLE			
DRAWN BY	DATE	CA12514_RITA-A	
mav	15.12.2011		
CHECKED BY	DATE	SIZE	DRAWING NUMBER
pv	15.12.2011	A4	CA12514
DESIGNED BY	DATE	SCALE	REV
hh/pl	07.12.2011	1:1	001
		WEIGHT (g)	SHEET
			1/1

PHOTOMETRIC DATA (MEASURED):



LED XB-D
 FWHM Asymmetric
 Efficiency 84 %
 LEDs/each optic 1
 Light colour White
 Required components:

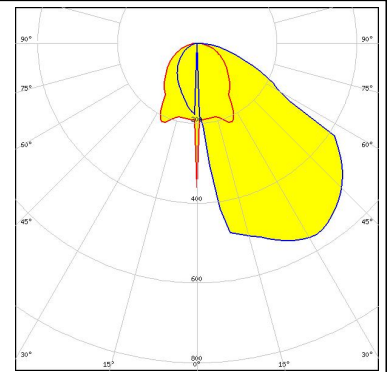

LED XM-L
 FWHM Asymmetric
 Efficiency 85 %
 Peak intensity 0.6 cd/lm
 LEDs/each optic 1
 Light colour White
 Required components:

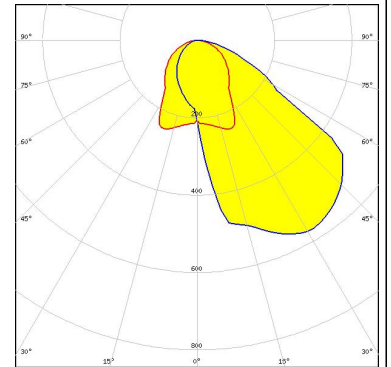

LED XM-L2
 FWHM Asymmetric
 Efficiency 86 %
 Peak intensity 0.6 cd/lm
 LEDs/each optic 1
 Light colour White
 Required components:

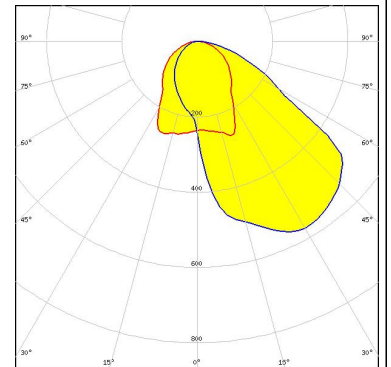
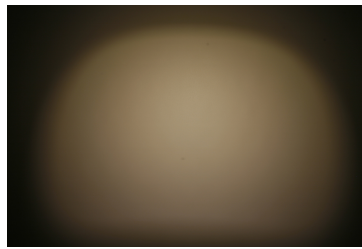

LED XP-G
 FWHM Asymmetric
 Efficiency 86 %
 LEDs/each optic 1
 Light colour White
 Required components:

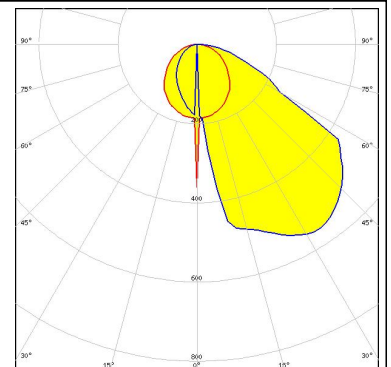

PHOTOMETRIC DATA (MEASURED):



LED XP-G2
 FWHM Asymmetric
 Efficiency 87 %
 Peak intensity 0.6 cd/lm
 LEDs/each optic 1
 Light colour White
 Required components:

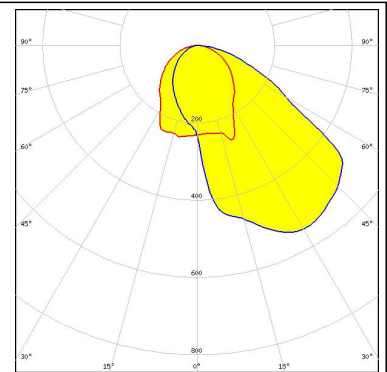

LED XT-E
 FWHM Asymmetric
 Efficiency 86 %
 LEDs/each optic 1
 Light colour White
 Required components:

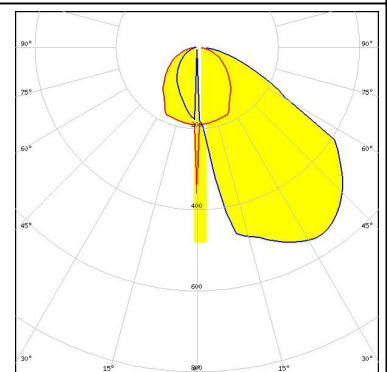

LED LUXEON A
 FWHM Asymmetric
 Efficiency 87 %
 Peak intensity 0.6 cd/lm
 LEDs/each optic 1
 Light colour White
 Required components:

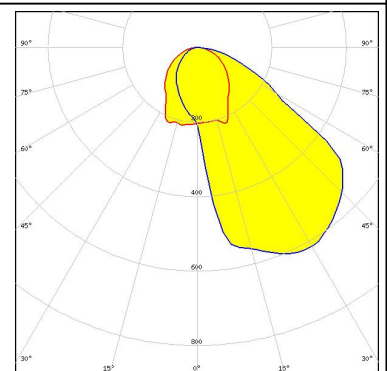
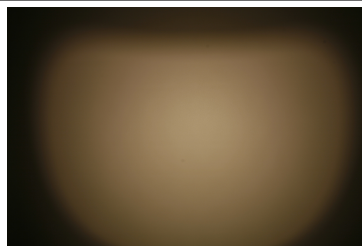

LED LUXEON Rebel
 FWHM Asymmetric
 Efficiency 87 %
 Peak intensity 0.6 cd/lm
 LEDs/each optic 1
 Light colour White
 Required components:

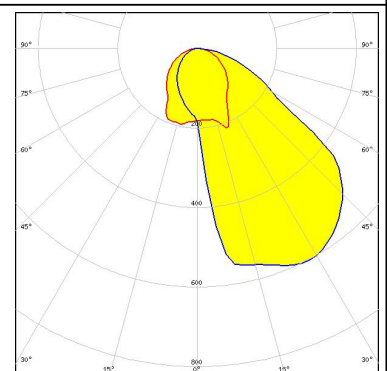

PHOTOMETRIC DATA (MEASURED):

LUMILEDS

LED LUXEON Rebel ES
 FWHM Asymmetric
 Efficiency 85 %
 LEDs/each optic 1
 Light colour White
 Required components:

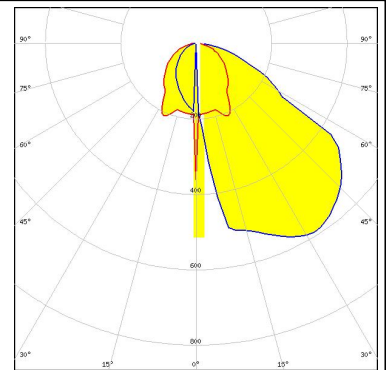

LUMILEDS

LED LUXEON T
 FWHM Asymmetric
 Efficiency 87 %
 Peak intensity 0.6 cd/lm
 LEDs/each optic 1
 Light colour White
 Required components:

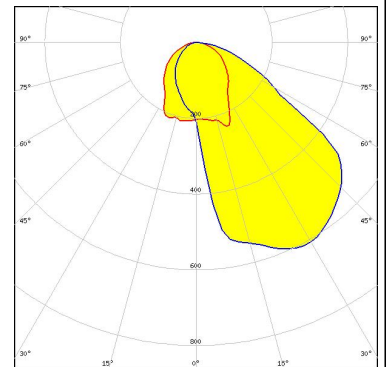
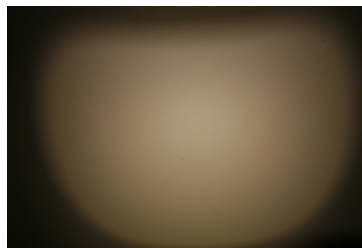

LUMILEDS

LED LUXEON TX
 FWHM Asymmetric
 Efficiency 87 %
 Peak intensity 0.6 cd/lm
 LEDs/each optic 1
 Light colour White
 Required components:

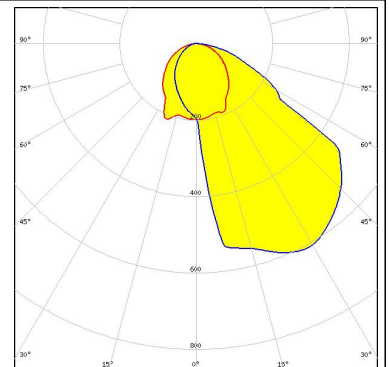
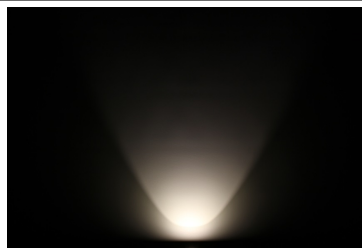

NICHIA

LED NCSxx19A
 FWHM Asymmetric
 Efficiency 86 %
 Peak intensity 0.6 cd/lm
 LEDs/each optic 1
 Light colour White
 Required components:

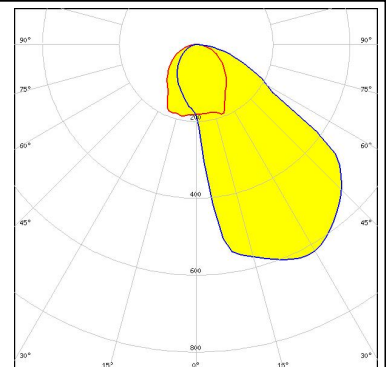
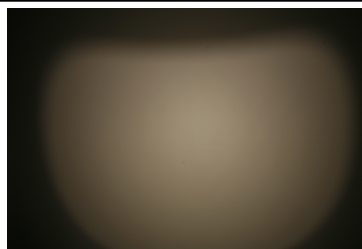

PHOTOMETRIC DATA (MEASURED):



LED NS9x383
 FWHM Asymmetric
 Efficiency 87 %
 Peak intensity 0.6 cd/lm
 LEDs/each optic 1
 Light colour White
 Required components:

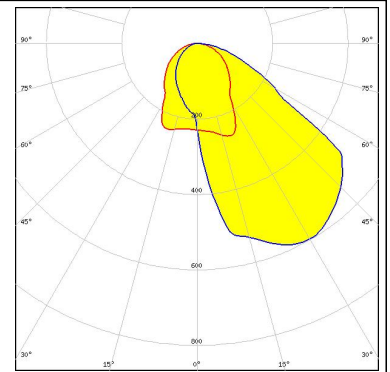

LED NVSxx19A
 FWHM Asymmetric
 Efficiency 86 %
 Peak intensity 0.6 cd/lm
 LEDs/each optic 1
 Light colour White
 Required components:

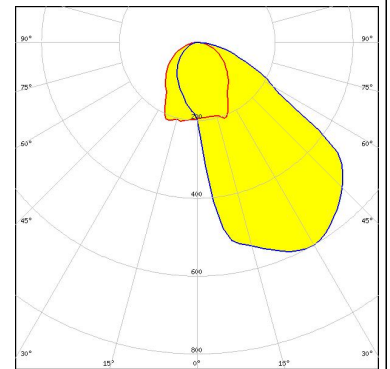

LED NVSxx19B/NVSxx19C
 FWHM Asymmetric
 Efficiency 86 %
 Peak intensity 0.6 cd/lm
 LEDs/each optic 1
 Light colour White
 Required components:

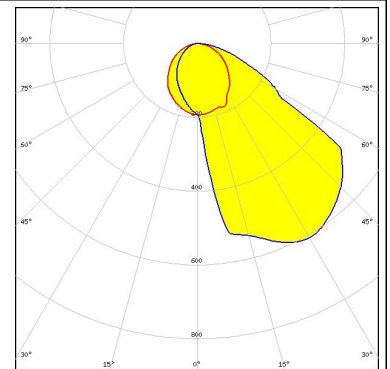

LED OSLOM SSL 150
 FWHM Asymmetric
 Efficiency 86 %
 Peak intensity 0.6 cd/lm
 LEDs/each optic 1
 Light colour White
 Required components:

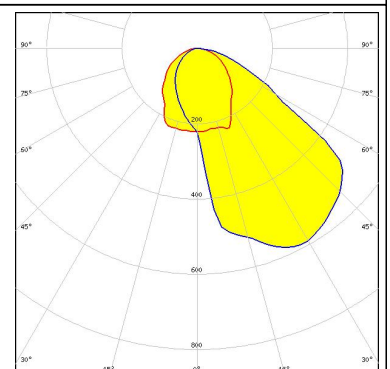

PHOTOMETRIC DATA (MEASURED):

OSRAM
Opto Semiconductors

LED	OSLON SSL 80
FWHM	Asymmetric
Efficiency	87 %
Peak intensity	0.6 cd/lm
LEDs/each optic	1
Light colour	White
Required components:	

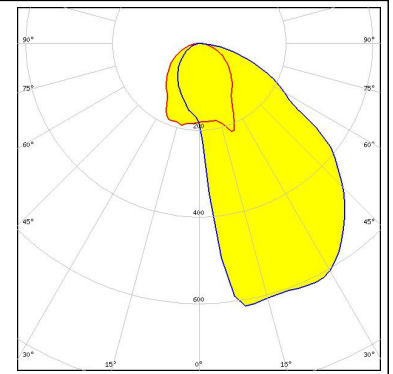
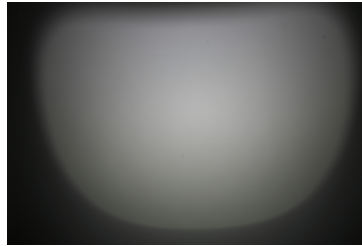

GENERAL INFORMATION:

NOTE: The typical beam angle will be changed by different color, chip size and chip position tolerance. The typical total beam angle is the full angle measured where the luminous intensity is half of the peak value.

MATERIALS:

As part of our continuous research and improvement processes, and to ensure the best possible quality and availability of our products, LEDiL reserves the right to change material grades without notice.

PRODUCT DATA USER AGREEMENT AND DISCLAIMER:

The measured data in the provided downloadable LEDiL Product Datasheets and Mechanical 2D-Drawings is rounded and provided as reference for planning. LEDiL Oy's optical specifications have been verified by conducting performance testing of the products in accordance with the company's quality system. The reported data are averaged results of multiple measurements with typical variation. LEDiL Oy reserves the right to without prior notification make changes and improvements to its products.

LEDiL Oy assumes neither warranty, nor guarantee nor any other liability of any kind for the contents and correctness of the provided data. The provided data has been generated with highest diligence but the provided data may in reality not represent the complete possible variation range of all intrinsic parameters. Therefore, in certain cases a deviation from the provided data could occur.

LEDiL Oy reserves the right to undertake technical changes of its products without further notification which could lead to changes in the provided data. LEDiL Oy assumes no liability of any kind for the possible deviation from any provided data or any other damage resulting from the usage of the provided data.

The user agrees to this disclaimer and user agreement with the download or usage of the provided files.

LEDiL Oy

Joensuunkatu 13
FI-24240 SALO
Finland

LEDiL Inc.

228 West Page Street
Suite D
Sycamore IL 60178
USA

Local sales and technical support

[www.ledil.com/
where_to_buy](http://www.ledil.com/where_to_buy)

Shipping locations

Salo, Finland
Hong Kong, China

Distribution Partners

[www.ledil.com/
where_to_buy](http://www.ledil.com/where_to_buy)