

High Efficacy  
Dental Blue LED Emitter  
**LZ4-00DB00**

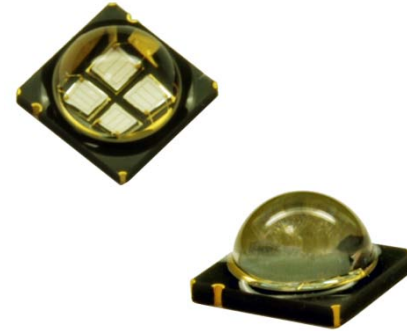

### Key Features

- High Efficacy 10W Dental Blue LED
- Ultra-small foot print – 7.0mm x 7.0mm
- Surface mount ceramic package with integrated glass lens
- Very low Thermal Resistance (1.1°C/W)
- Individually addressable die
- Very high Radiant Flux density
- JEDEC Level 1 for Moisture Sensitivity Level
- Autoclave complaint (JEDEC JESD22-A102-C)
- Lead (Pb) free and RoHS compliant
- Reflow solderable (up to 6 cycles)
- Emitter available on Standard MCPCB (optional)

### Typical Applications

- Dental Curing
- Teeth Whitening

### Description

The LZ4-00DB00 Dental Blue LED emitter provides superior radiometric power in the wavelength range specifically required for dental curing light applications. With a 7.0mm x 7.0mm ultra-small footprint, this package provides exceptional optical power density making it ideal for use in dental curing devices. The radiometric power performance and optimal peak wavelength of this LED are matched to the response curves of many dental resins, resulting in a significantly reduced curing time. LED Engin's LZ4-00DB00 offers ultimate design flexibility with individually addressable die. The patent-pending design has unparalleled thermal and optical performance. The high quality materials used in the package are chosen to optimize light output, have excellent UV resistance, and minimize stresses which results in monumental reliability and radiant flux maintenance.

## Part number options

### Base part number

Part number	Description
LZ4-00DB00-xxxx	LZ4 emitter
LZ4-40DB00-xxxx	LZ4 emitter on Standard Star 1 channel MCPCB

Notes:

1. See "Part Number Nomenclature" for full overview on LED Engin part number nomenclature.

### Bin kit option codes

DB, Dental-Blue (460nm)			
Kit number suffix	Min flux Bin	Color Bin Range	Description
0000	Q	D1 – D1	full distribution flux; full distribution wavelength
R000	R	D1 – D1	R minimum flux bin; full distribution wavelength

Notes:

1. Default bin kit option is -0000

## Radiant Flux Bins

Table 1:

Bin Code	Minimum Radiant Flux ( $\Phi$ ) @ $I_F = 700\text{mA}$ <sup>[1,2]</sup> (W)	Maximum Radiant Flux ( $\Phi$ ) @ $I_F = 700\text{mA}$ <sup>[1,2]</sup> (W)
Q	2.0	2.4
R	2.4	3.0
S	3.0	3.8

Notes for Table 1:

1. Radiant flux performance guaranteed within published operating conditions. LED Engin maintains a tolerance of  $\pm 10\%$  on flux measurements.
2. Future products will have even higher levels of radiant flux performance. Contact LED Engin Sales for updated information.

## Peak Wavelength Bin

Table 2:

Bin Code	Minimum Peak Wavelength ( $\lambda_p$ ) @ $I_F = 700\text{mA}$ <sup>[1]</sup> (nm)	Maximum Peak Wavelength ( $\lambda_p$ ) @ $I_F = 700\text{mA}$ <sup>[1]</sup> (nm)
D1	457	463

Notes for Table 2:

1. LED Engin maintains a tolerance of  $\pm 2.0\text{nm}$  on peak wavelength measurements.

## Forward Voltage Bin

Table 3:

Bin Code	Minimum Forward Voltage ( $V_F$ ) @ $I_F = 700\text{mA}$ <sup>[1,2]</sup> (V)	Maximum Forward Voltage ( $V_F$ ) @ $I_F = 700\text{mA}$ <sup>[1,2]</sup> (V)
0	12.80	16.64

Notes for Table 3:

1. LED Engin maintains a tolerance of  $\pm 0.04\text{V}$  for forward voltage measurements.
2. Forward Voltage is binned with all four LED dice connected in series.

## Absolute Maximum Ratings

Table 4:

Parameter	Symbol	Value	Unit
DC Forward Current at $T_{jmax}=135^{\circ}\text{C}^{[1]}$	$I_F$	1200	mA
DC Forward Current at $T_{jmax}=150^{\circ}\text{C}^{[1]}$	$I_F$	1000	mA
Peak Pulsed Forward Current <sup>[2]</sup>	$I_{FP}$	1500	mA
Reverse Voltage	$V_R$	See Note 3	V
Storage Temperature	$T_{stg}$	-40 ~ +150	$^{\circ}\text{C}$
Junction Temperature	$T_J$	150	$^{\circ}\text{C}$
Soldering Temperature <sup>[4]</sup>	$T_{sol}$	260	$^{\circ}\text{C}$
Allowable Reflow Cycles		6	
Autoclave Conditions <sup>[5]</sup>		121 $^{\circ}\text{C}$ at 2 ATM, 100% RH for 168 hours	
ESD Sensitivity <sup>[6]</sup>		> 8,000 V HBM Class 3B JESD22-A114-D	

Notes for Table 4:

- Maximum DC forward current is determined by the overall thermal resistance and ambient temperature. Follow the curves in Figure 10 for current derating.
- Pulse forward current conditions: Pulse Width  $\leq$  10msec and D duty Cycle  $\leq$  10%.
- LEDs are not designed to be reverse biased.
- Solder conditions per JEDEC 020c. See Reflow Soldering Profile Figure 3.
- Autoclave Conditions per JEDEC JESD22-A102-C.
- LED Engin recommends taking reasonable precautions towards possible ESD damages and handling the LZ4-00DB00 in an electrostatic protected area (EPA). An EPA may be adequately protected by ESD controls as outlined in ANSI/ESD S6.1.

## Optical Characteristics @ $T_C = 25^{\circ}\text{C}$

Table 5:

Parameter	Symbol	Typical	Unit
Radiant Flux (@ $I_F = 700\text{mA}$ )	$\Phi$	2.6	W
Radiant Flux (@ $I_F = 1000\text{mA}$ )	$\Phi$	3.5	W
Peak Wavelength <sup>[1]</sup>	$\lambda_P$	460	nm
Viewing Angle <sup>[2]</sup>	$2\Theta_{\frac{1}{2}}$	110	Degrees
Total Included Angle <sup>[3]</sup>	$\Theta_{0.9}$	120	Degrees

Notes for Table 5:

- Observe IEC 60825-1 class 2 rating for eye safety. Do not stare into the beam.
- Viewing Angle is the off axis angle from emitter centerline where the luminous intensity is  $\frac{1}{2}$  of the peak value.
- Total Included Angle is the total angle that includes 90% of the total luminous flux.

## Electrical Characteristics @ $T_C = 25^{\circ}\text{C}$

Table 6:

Parameter	Symbol	Typical		Unit
		1 Die	4 Dice	
Forward Voltage (@ $I_F = 700\text{mA}$ )	$V_F$	3.5	14.0	V
Forward Voltage (@ $I_F = 1000\text{mA}$ )	$V_F$	3.7	14.6	V
Temperature Coefficient of Forward Voltage	$\Delta V_F/\Delta T_J$	-10.4		mV/ $^{\circ}\text{C}$
Thermal Resistance (Junction to Case)	$RO_{J-C}$	1.1		$^{\circ}\text{C}/\text{W}$

## IPC/JEDEC Moisture Sensitivity Level

Table 7 - IPC/JEDEC J-STD MSL-20 Classification:

Level	Floor Life		Soak Requirements			
	Time	Conditions	Standard	Accelerated	Time (hrs)	Conditions
1	Unlimited	≤ 30°C/ 85% RH	168 +5/-0	85°C/ 85% RH	n/a	n/a

Notes for Table 7:

1. The standard soak time is the sum of the default value of 24 hours for the semiconductor manufacturer's exposure time (MET) between bake and bag and the floor life of maximum time allowed out of the bag at the end user of distributor's facility.

## Average Radiant Flux Maintenance Projections

Based on long-term WHTOL testing, LED Engin projects that the LZ Series will deliver, on average, 70% Radiant Flux Maintenance at 65,000 hours of operation at a forward current of 700 mA. This projection is based on constant current operation with junction temperature maintained at or below 125°C.



### Recommended Solder Mask Layout (mm)

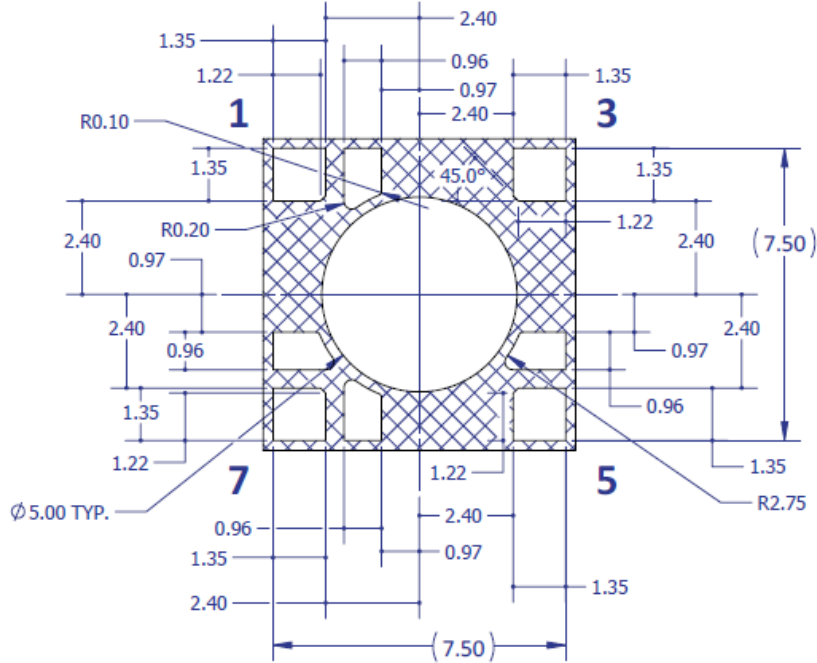

Figure 2b: Recommended solder mask opening (hatched area) for anode, cathode, and thermal pad.

Note for Figure 2b:

- 1. Unless otherwise noted, the tolerance = ± 0.20 mm.

### Reflow Soldering Profile

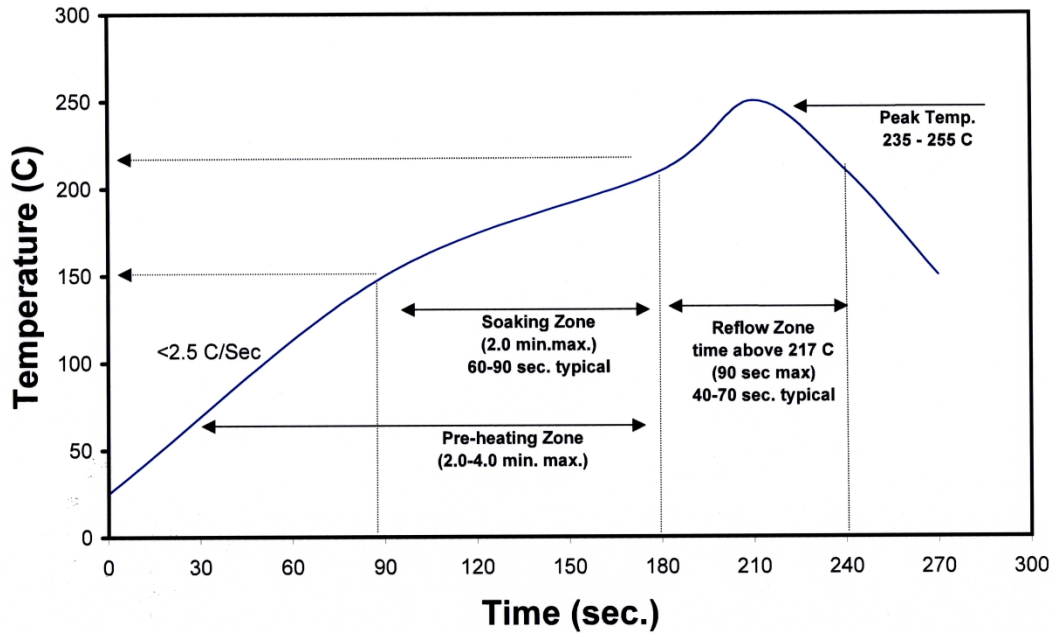

Figure 3: Reflow soldering profile for lead free soldering.

### Typical Radiation Pattern

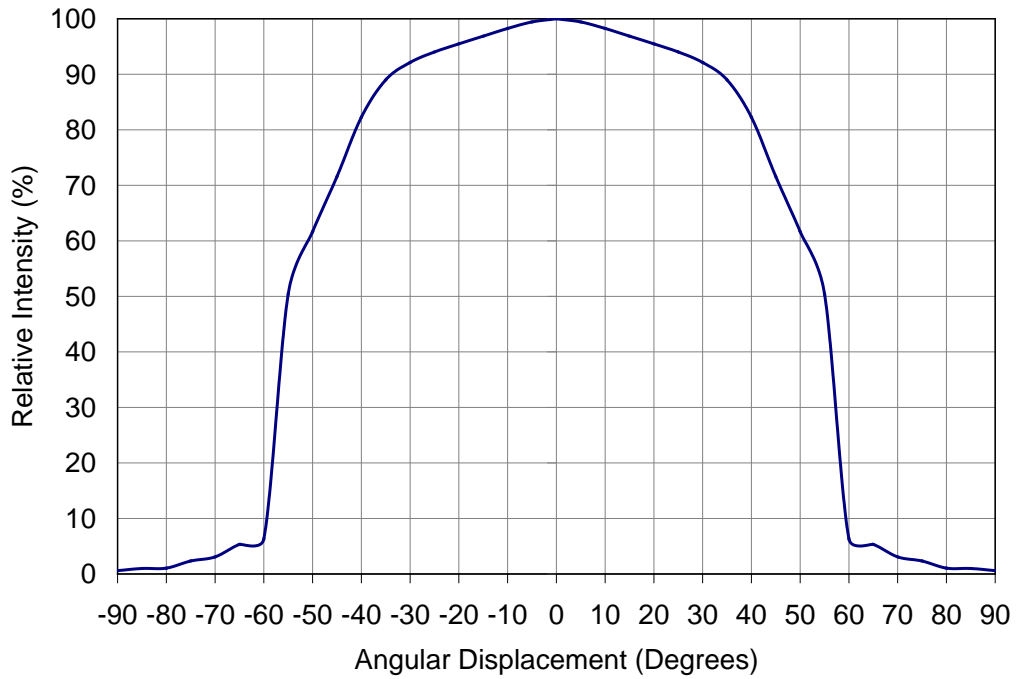

Figure 4: Typical representative spatial radiation pattern.

### Typical Relative Spectral Power Distribution

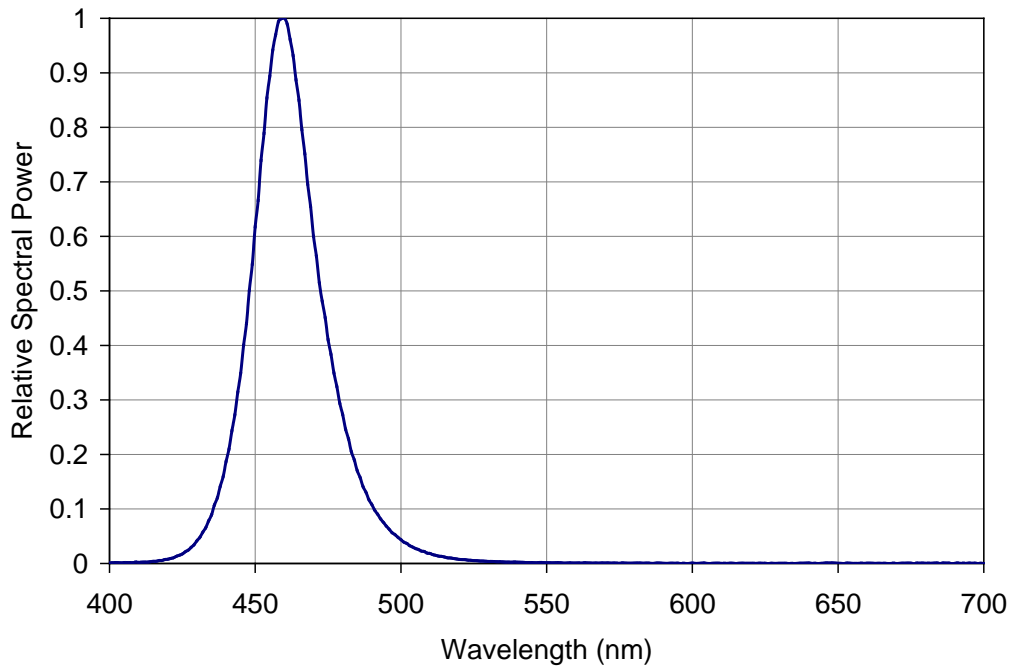

Figure 5: Typical relative spectral power vs. wavelength @ T<sub>c</sub> = 25°C.



### Typical Peak Wavelength Shift over Temperature

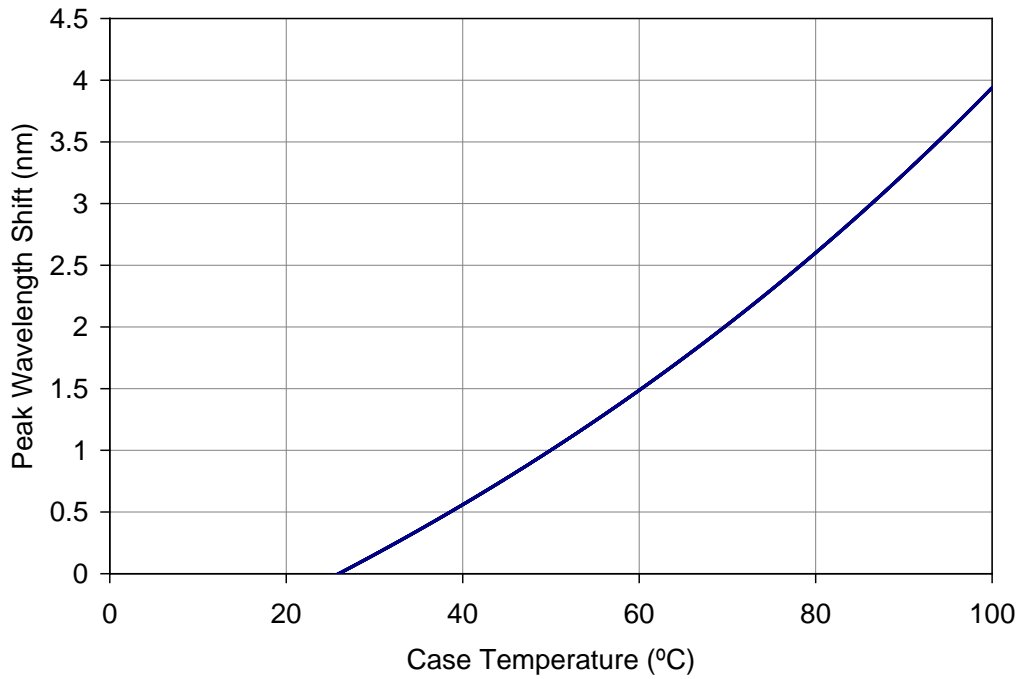

Figure 6: Typical peak wavelength shift vs. case temperature.

### Typical Normalized Radiant Flux

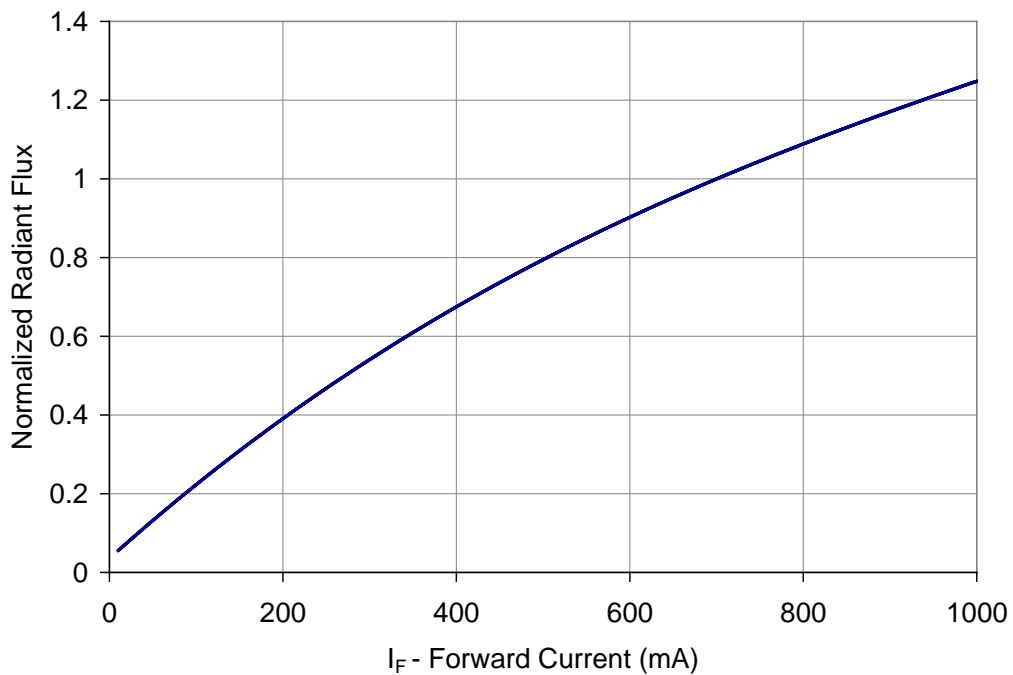

Figure 7: Typical normalized radiant flux vs. forward current @ T<sub>c</sub> = 25°C.

### Typical Normalized Radiant Flux over Temperature

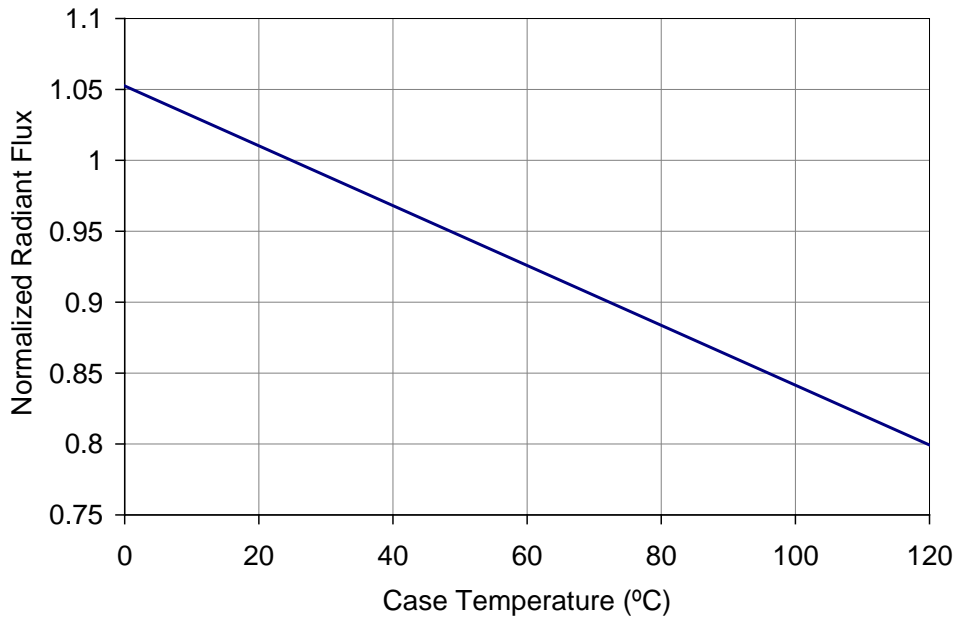

Figure 8: Typical normalized radiant flux vs. case temperature.

### Typical Forward Current Characteristics

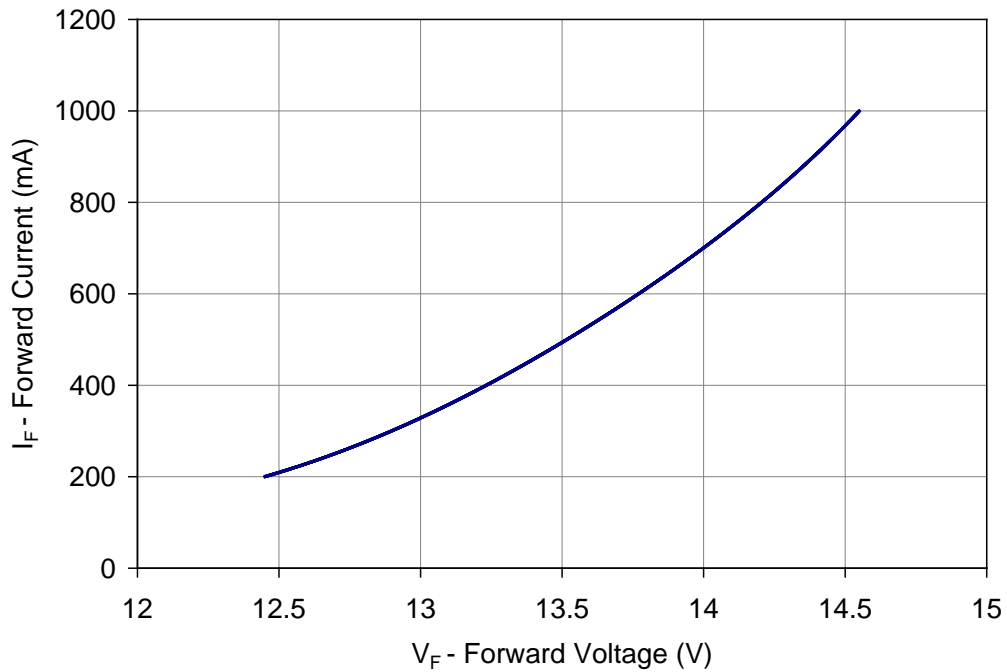

Figure 9: Typical forward current vs. forward voltage @ T<sub>c</sub> = at 25°C.

## Current De-rating

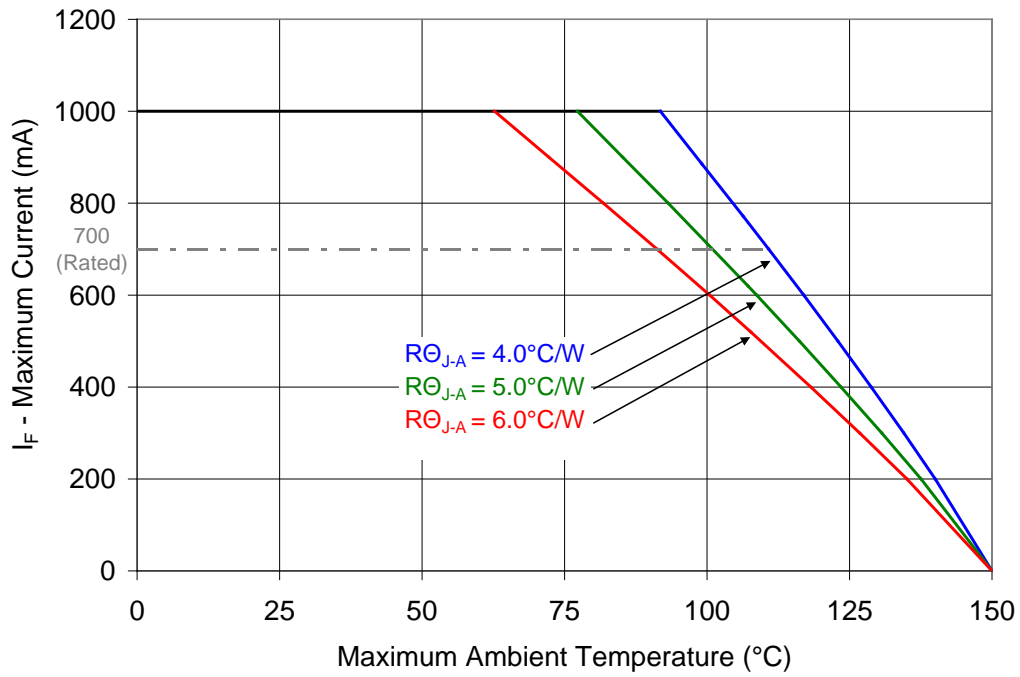

Figure 10: Maximum forward current vs. ambient temperature based on  $T_{j(\text{MAX})} = 150^{\circ}\text{C}$ .

Notes for Figure 10:

1.  $R_{\theta_{J-C}}$  [Junction to Case Thermal Resistance] for the LZ4-00DB00 is typically  $1.1^{\circ}\text{C/W}$ .
2.  $R_{\theta_{J-A}}$  [Junction to Ambient Thermal Resistance] =  $R_{\theta_{J-C}} + R_{\theta_{C-A}}$  [Case to Ambient Thermal Resistance].

### Emitter Tape and Reel Specifications (mm)

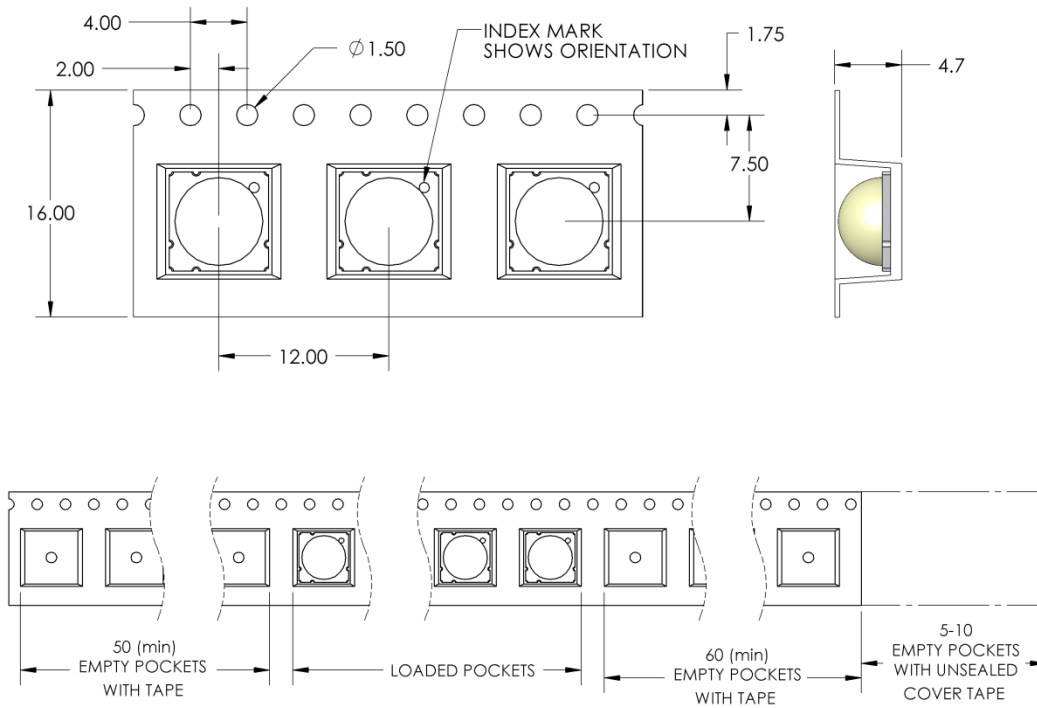

Figure 11: Emitter carrier tape specifications (mm).

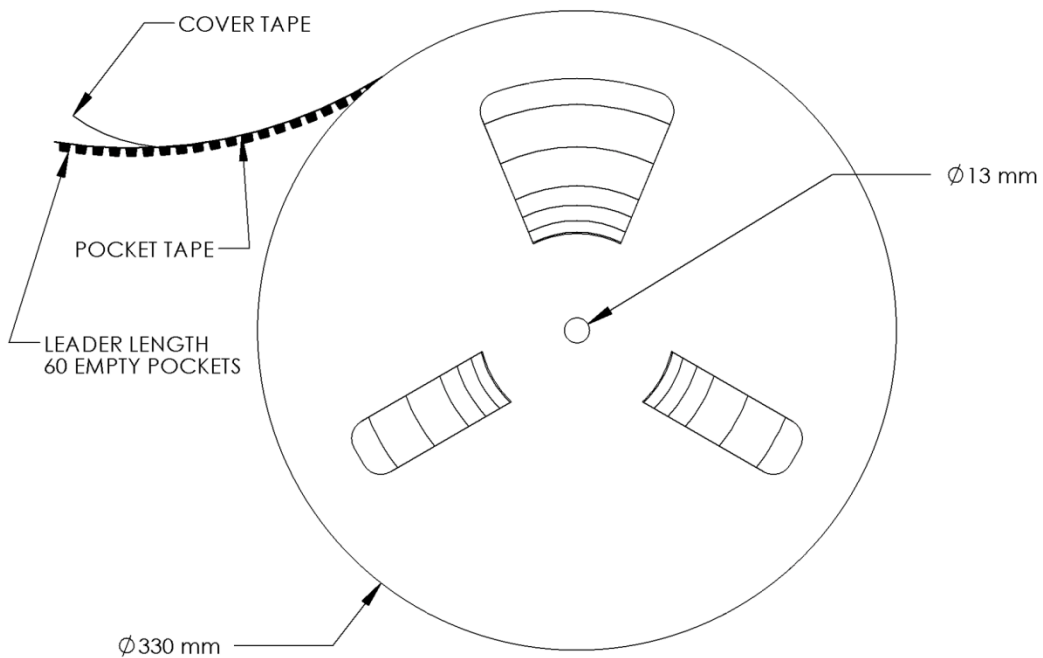

Figure 12: Emitter Reel specifications (mm).

## Part-number Nomenclature

The LZ Series base part number designation is defined as follows:

### LZ A – B C D E F G – H I J K

A – designates the number of LED die in the package

- 1 for single die emitter package
- 4 for 4-die emitter package
- 9 for 9-die emitter package
- C for 12-die emitter package
- P for 25-die emitter package

B – designates the package level

- 0 for Emitter only

Other letters indicate the addition of a MCPCB. See appendix “MCPCB options” for details

C – designates the radiation pattern

- 0 for Clear domed lens (Lambertian radiation pattern)
- 1 for Flat-top
- 3 for Frosted domed lens

D and E – designates the color

- U6 Ultra Violet (365nm)
- UA Violet (400nm)
- DB Dental Blue (460nm)
- B2 Blue (465nm)
- G1 Green (525nm)
- A1 Amber (590nm)
- R1 Red (623nm)
- R2 Deep Red (660nm)
- R3 Far Red (740nm)
- WW Warm White (2700K-3500K)
- W9 Warm White CRI 90 Minimum (2700K-3500K)
- NW Neutral White (4000K)
- CW Cool White (5500K-6500K)
- W2 Warm & Cool White mixed dies
- MC RGB
- MA RGBA
- MD RGBW (6500K)

F and G – designates the package options if applicable

See “Base part number” on page 2 for details. Default is “00”

H, I, J, K – designates kit options

See “Bin kit options” on page 2 for details. Default is “0000”

### Ordering information:

For ordering LED Engin products, please reference the base part number above. The base part number represents our standard full distribution flux and wavelength range. Other standard bin combinations can be found on page 2. For ordering products with custom bin selections, please contact a LED Engin sales representative or authorized distributor.

# LZ4 MCPCB Family

Part number	Type of MCPCB	Diameter (mm)	Typical $V_f$ (V)	Typical $I_f$ (mA)
LZ4-4xxxxxx	1-channel	19.9	14.0	700

- **Mechanical Mounting of MCPCB**
  - Mechanical stress on the emitter that could be caused by bending the MCPCB should be avoided. The stress can cause the substrate to crack and as a result might lead to cracks in the dies.
  - Therefore special attention needs to be paid to the flatness of the heat sink surface and the torque on the screws. Maximum torque should not exceed 1 Nm (8.9 lbf/in).
  - Care must be taken when securing the board to the heatsink to eliminate bending of the MCPCB. This can be done by tightening the three M3 screws (or #4-40) in steps and not all at once. This is analogous to tightening a wheel of an automobile
  - It is recommended to always use plastic washers in combination with three screws. Two screws could more easily lead to bending of the board.
  - If non taped holes are used with self-tapping screws it is advised to back out the screws slightly after tighten (with controlled torque) and retighten the screws again.
  
- **Thermal interface material**
  - To properly transfer the heat from the LED to the heatsink a thermally conductive material is required when mounting the MCPCB to the heatsink
  - There are several materials which can be used as thermal interface material, such as thermal paste, thermal pads, phase change materials and thermal epoxies. Each has pro's and con's depending on the application. For our emitter it is critical to verify that the thermal resistance is sufficient for the selected emitter and its environment.
  - To properly transfer the heat from the MCPCB to the heatsink also special attention should be paid to the flatness of the heatsink.
  
- **Wire soldering**
  - For easy soldering of wires to the MCPCB it is advised to preheat the MCPCB on a hot plate to a maximum of 150°. Subsequently apply the solder and additional heat from the solder iron to initiate a good solder reflow. It is recommended to use a solder iron of more than 60W. We advise to use lead free, no-clean solder. For example SN-96.5 AG-3.0 CU 0.5 #58/275 from Kester (pn: 24-7068-7601)

# LZ4 Emitter on 1 channel star MCPCB

## LZ4-4xxxxx

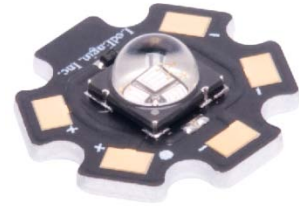

### Key Features

- Supports 4 LED dies in series
- Very low thermal Resistance for MCPCB adds only 1.1°C/W
- Multiple mounting and attachment options
- MCPCB contains Zener Diode for ESD protection
- LED Engin LZ4 Lens family (12 to 37deg) aligns with the MCPCB cutouts
- 19.9mm diameter standard star MCPCB

### Description

The LZ4-4xxxxx Standard MCPCB option provides a convenient method to mount LED Engin’s LZ4 emitters. The MCPCB connects all 4 LED die in series and provides 2 anode and 3 cathode contact pads. The six recessed features allow the use of M3 or #4 screws to attach the MCPCB to a heat sink. The MCPCB has three sets of “+” (Anode) and “-” (Cathode) solder pads for electrical connections. The MCPCB also contains a Zener diode for enhanced ESD protection.

### R $\theta_{J-B}$ Lookup Table

Product	Emitter $\theta_{J-C}$		MCPCB $R\theta_{C-B}$	=	Emitter + MCPCB $R\theta_{J-B}$
LZ4-4xxxxx	1.1°C/W	+	1.1°C/W	=	2.2°C/W

Note:

- $R\theta_{J-B}$  is the combined thermal resistance from the LED die junction to the Aluminum core on MCPCB ( $R\theta_{J-C} + R\theta_{C-B} = R\theta_{J-B}$ ).

## Company Information

LED Engin, Inc., based in California's Silicon Valley, specializes in ultra-bright, ultra compact solid state lighting solutions allowing lighting designers & engineers the freedom to create uncompromised yet energy efficient lighting experiences. The LuxiGen™ Platform — an emitter and lens combination or integrated module solution, delivers superior flexibility in light output, ranging from 3W to 90W, a wide spectrum of available colors, including whites, multi-color and UV, and the ability to deliver upwards of 5,000 high quality lumens to a target. The small size combined with powerful output allows for a previously unobtainable freedom of design wherever high-flux density, directional light is required. LED Engin's packaging technologies lead the industry with products that feature lowest thermal resistance, highest flux density and consummate reliability, enabling compact and efficient solid state lighting solutions.

LED Engin is committed to providing products that conserve natural resources and reduce greenhouse emissions.

LED Engin reserves the right to make changes to improve performance without notice.

Please contact [sales@ledengin.com](mailto:sales@ledengin.com) or (408) 922-7200 for more information.