

# Datasheet

## BL651 Series

Supports Laird Part Numbers:

- 453-00005
- 453-00006
- 453-00005C
- 453-00006C

## REVISION HISTORY

Version	Date	Notes	Contributor(s)	Approver
1.0	24 Sept 2018	Initial Release	Andrew Chen Raj Khatri	Jonathan Kaye
1.1	12 Feb 2019	Updated logos and URLs		Sue White

## CONTENTS

1	Overview and Key Features .....	4
2	Specification .....	5
3	Hardware Specifications .....	7
3.1	Block Diagram and Pin-out.....	7
3.2	Pin Definitions .....	8
3.3	Electrical Specifications.....	9
4	Power Consumption .....	13
5	Functional Description .....	15
5.1	Power Management (includes Brown-out and Power on Reset) .....	16
5.2	Clocks and Timers .....	17
5.3	Memory .....	17
5.4	Radio Frequency (RF).....	17
5.5	UART Interface .....	17
5.6	SPI Bus .....	18
5.7	I2C Interface.....	19
5.8	General Purpose I/O, ADC, PWM, and FREQ .....	20
5.8.1	GPIO .....	20
5.8.2	ADC.....	20
5.8.3	PWM Signal Output on SIO Pins.....	20
5.9	nRESET pin .....	21
5.10	Two-wire Interface SWD .....	21
5.11	BL651 Wakeup.....	23
5.12	Low Power Modes.....	23
5.13	Temperature Sensor .....	23
5.14	Security/Privacy .....	23
5.14.1	AES Encryption/Decryption .....	23
5.14.2	Readback Protection .....	23
5.14.3	Elliptic Curve Cryptography .....	23
5.15	Optional External 32.768 kHz Crystal.....	23
5.16	453-00005 On-board PCB Trace Antenna Characteristics.....	25
6	Hardware Integration Suggestions .....	27
6.1	Circuit .....	27
6.2	PCB Layout on Host PCB - General .....	28
6.3	PCB Layout on Host PCB for 453-00005.....	28
6.3.1	Antenna Keep-out on Host PCB.....	28
6.3.2	Antenna Keep-out and Proximity to Metal or Plastic .....	29
6.4	External Antenna Integration with 453-00006 .....	29
7	Mechanical Details .....	30
7.1	BL651 Mechanical Details.....	30
7.2	Host PCB Land Pattern and Antenna Keep-out for 453-00005.....	31
8	Application Note for Surface Mount Modules .....	32
8.1	Introduction .....	32
8.2	Shipping.....	32
8.3	Reflow Parameters.....	35
9	FCC and IC Regulatory .....	37
10	Japan (MIC) Regulatory .....	40
11	CE Regulatory .....	41
12	Ordering Information.....	42
13	Bluetooth SIG Qualification .....	42
14	Additional Assistance .....	44

## 1 OVERVIEW AND KEY FEATURES

Laird's BL651 Series contains the latest Nordic nRF52810 silicon with **Bluetooth 5 Low Energy, ANT and Proprietary 2.4 GHz** capabilities and groundbreaking ultra-low power performance. Building on Laird's multi-generation module developments utilizing Nordic silicon (BL600, BL652, BL654) – now comes the latest series offering **cost effective** Bluetooth 5 enablement for simple BLE applications.

The BL651 series exposes all the capabilities of the Nordic nRF52810 silicon in a small, fully certified module with simple soldering castellation for easy prototyping and mass production manufacturing. Use the **Nordic SDK & SoftDevice** to deliver your BLE application. Let Laird's innovative BL651 series and decades of expertise in Bluetooth module design speed your product to market.

In addition, the BL651 series is 100% PCB footprint **drop in compatible** with the BL652 Series of modules.



### 1.1 Features and Benefits

- Bluetooth v5.0 – Single mode
- External or internal antennas
- Application development via Nordic SDK or Zephyr
- Compact footprint (pin compatible with BL652)
- Programmable Tx power +4 dBm to -20 dBm
- Tx whisper mode (-40 dBm)
- Rx sensitivity: -96 dBm
- Ultra-low power consumption
- Tx: 4.6 mA peak (at 0 dBm, DCDC on) – See *Power Consumption* section Note 1
- Rx: 4.6 mA peak (DCDC on) – See *Power Consumption* section Note 1
- System ON IDLE: 1.5 uA typical
- System OFF: 0.3 uA – See *Power Consumption* section Note 4
- UART, GPIO, ADC, PWM, timers, I2C, and SPI interfaces
- Fast time-to-market
- FCC, CE, IC, and Japan certified; Full Bluetooth Declaration ID
- Other regulatory certifications on request
- No external components required
- Industrial temperature range (-40 to + 85)

### 1.2 Application Areas

- Beacons
- Computer peripherals
- Home healthcare
- Fitness sensors
- IoT sensors
- Home automation

---

**Note:** Figures on this page are gathered from the nRF52810 datasheet v1.2 provided by Nordic.

---

## 2 SPECIFICATION

### Specification Summary

**Table 1: BL651 Specifications**

Categories	Feature	Implementation	
<b>Wireless Specification</b>	Bluetooth®	V5.0 – Single mode	
	Other	ANT, Nordic Proprietary 2.4 GHz	
	Frequency	2.402 - 2.480 GHz	
	Maximum Transmit Power Setting	+4 dBm	Conducted 453-00005 (internal antenna)
		+4 dBm	Conducted 453-00006 (external antenna)
	Minimum Transmit Power Setting	-40 dBm, -20 dBm (in 4-dB steps)	
		-16 dBm, -12 dBm, - 8 dBm, - 4 dBm, 0 dBm	
	Receive Sensitivity (≤37-byte packet)	-96 dBm (BER=1E-3) typical	
	Link Budget	100 dB (@ 1 Mbps)	
	Range	Up to 100 meters in free space	
Raw Data Rates	1 Mbps (over-the-air)		
	2 Mbps (over-the-air)		
<b>Host Interface and Peripherals</b>	Total	32 x Multifunction I/O lines	
	UART	Configurable	
	GPIO	Up to 32, with configurable:	
		▪ I/O direction	
		▪ O/P drive strength (standard 0.5 mA or high 3mA/5 mA)	
	ADC	Eight 8/10/12-bit channels	
		0.6 V internal reference	
	PWM output	Configurable 4, 2, 1, 1/2, 1/3, 1/4, 1/5 1/6 pre-scaling	
		Configurable acquisition time 3uS, 5uS, 10uS, 15uS, 20uS, 40uS	
	I2C	One-shot mode	
PWM outputs on GPIO output pins			
SPI	PWM output duty cycle: 0%-100%		
	PWM output frequency: Up to 500 kHz		
Optional <i>External to the BL651 module</i>	I2C	One I2C interface (up to 400 kbps) (See Module Specification <a href="#">Note 1</a> )	
	SPI	One SPI master and slave (up to 4 Mbps) (See Module Specification <a href="#">Note 2</a> )	
<b>Programmability</b>	External 32.768 kHz crystal	For customer use, connect +/-20 ppm accuracy crystal for more accurate protocol timing.	
	Nordic SDK or Zephyr	Via JTAG	
<b>Supply Voltage</b>	Supply (VCC)	Any exposed within the related Nordic Softdevice (application development to be done by OEM)	
		1.7 – 3.6 V – Internal DCDC converter or LDO (See Module Specification <a href="#">Note 3</a> )	
<b>Power Consumption</b> (See Module Specification <a href="#">Error! Reference source not found.</a> )	Active Modes Peak Current (for maximum Tx power +4 dBm) – Radio only	Advertising mode	7.0 mA peak Tx (with DCDC)
		Connecting mode	7.0 mA peak Tx (with DCDC)
	Active Modes Peak Current (for minimum Tx power -40 dBm) – Radio only	Advertising mode	2.1 mA peak Tx (with DCDC)
		Connecting mode	2.1 mA peak Tx (with DCDC)
Active Modes Average Current	Depends on many factors, see <a href="#">Power Consumption</a>		

Categories	Feature	Implementation
	Ultra Low Power Modes	System ON IDLE System OFF 1.5 uA typical (See Module Specification <a href="#">Error! Reference source not found.</a> ) 300 nA (See Module Specification <a href="#">Error! Reference source not found.</a> )
<b>Antenna Options</b>	Internal	PCB trace monopole antenna – on-board <b>part # 453-00005</b>
	External	Connection via IPEX MHF4 – <b>part # 453-00006</b> See the Antenna Information sections for <a href="#">FCC and IC, MIC, and CE</a> .
<b>Physical</b>	Dimensions	14 mm x 10 mm x 2.1 mm Pad Pitch: 0.75 mm Pad Type: Plated half-moon edge pads (easy to hand solder)
	Weight	<1 gram
<b>Environmental</b>	Operating	-40 °C to +85 °C (VCC 1.8V-3.6V)
	Storage	-40 °C to +85 °C
<b>Miscellaneous</b>	Lead Free	Lead-free and RoHS compliant
	Warranty	1-Year Warranty
	MSL Level	4
<b>Approvals</b>	Bluetooth®	Full Bluetooth SIG Declaration ID
	FCC/IC/CE/MIC/RCM	All BL651 Series

**Module Specification Notes:**

- Note 1** With I2C interface selected, pull-up resistors on I2C SDA and I2C SCL **must** be connected externally as per I2C standard.
- Note 2** SPI interface consists of SPI MOSI, SPI MISO, and SPI CLK. SPI CS is created by using any spare SIO pin within the customer’s application allowing multi-dropping.
- Note 3** Use of the internal DCDC convertor or LDO is decided by the underlying BLE stack.

### 3 HARDWARE SPECIFICATIONS

#### 3.1 Block Diagram and Pin-out

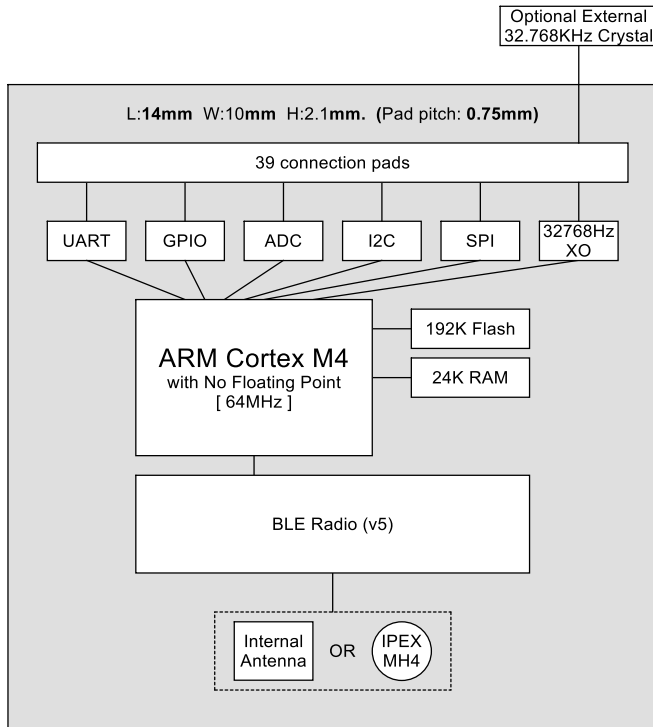

Figure 1: BL651 Block diagram

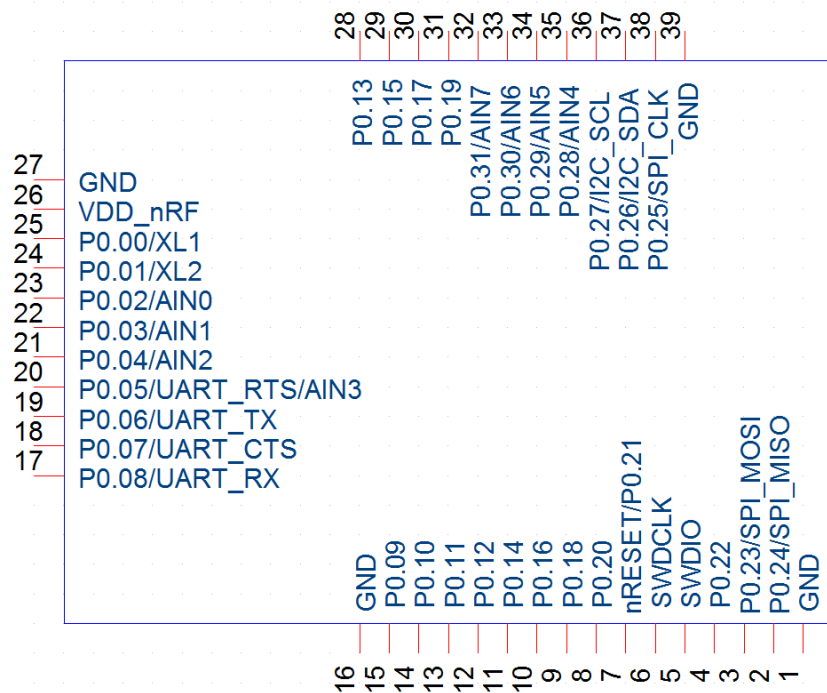

Figure 2: BL651 module pin-out (top view)

## 3.2 Pin Definitions

**Table 2: Pin definitions**

BL651 Pin #	BL651 Pin Name	nRF52810 QFN Name	nRF52810 QFN Pin#	BL652 Equivalent Pin Name	Notes	Comment
1	GND	-	-	GND		-
2	P0.24/SPI_MISO	P0.24	29	SIO_24/SPI_MISO	Pin Definitions <a href="#">Note 1</a>	-
3	P0.23/SPI_MOSI	P0.23	28	SIO_23/SPI_MOSI	Pin Definitions <a href="#">Note 1</a>	-
4	P0.22	P0.22	27	SIO_22		-
5	SWDIO	SWDIO	26	SWDIO	Pin Definitions <a href="#">Note 2</a>	-
6	SWDCLK	SWDCLK	25	SWDCLK	Pin Definitions <a href="#">Note 2</a>	-
7	nRESET/ P0.21	P0.21/nRESET	24	nRESET	Pin Definitions <a href="#">Note 3</a>	System Reset (Active Low)
8	P0.20	P0.20	23	SIO_20/SFLASH_MOSI		-
9	P0.18	P0.18	21	SIO_18		-
10	P0.16	P0.16	19	SIO_16/SFLASH_C LK		-
11	P0.14	P0.14	17	SIO_14/SFLASH_MISO		-
12	P0.12	P0.12	15	SIO_12/SFLASH_C S		-
13	P0.11	P0.11	14	SIO_11		-
14	P0.10	P0.10	12	NFC2/SIO_10		-
15	P0.09	P0.09	11	NFC1/SIO_09		-
16	GND	-	-	GND		-
17	P0.08/UART_RX	P0.08	10	SIO_08/UART_RX	Pin Definitions <a href="#">Note 1</a>	
18	P0.07/UART_CTS	P0.07	9	SIO_07/UART_CTS	Pin Definitions <a href="#">Note 1</a>	
19	P0.06/UART_TX	P0.06	8	SIO_06/UART_TX	Pin Definitions <a href="#">Note 1</a>	
20	P0.05/UART_RTS/ AIN3	P0.05/AIN3	7	SIO_05/UART_RTS/ S/AIN3	Pin Definitions <a href="#">Note 1</a>	
21	P0.04/AIN2	P0.04/AIN2	6	SIO_04/AIN2		
22	P0.03/AIN1	P0.03/AIN1	5	SIO_03/AIN1		
23	P0.02/AIN0	P0.02/AIN0	4	SIO_02/AIN0		
24	P0.01/XL2	P0.01/XL2	3	SIO_01/XL2	Pin Definitions <a href="#">Note 4</a>	
25	P0.00/XL1	P0.00/XL1	2	SIO_00/XL1	Pin Definitions <a href="#">Note 4</a>	
26	VDD_nRF	-	-	VDD_nRF		1.7V to 3.6V
27	GND	-	-	GND		-
28	P0.13	P0.13	16	SIO_13/nAutoRU N		
29	P0.15	P0.15	18	SIO_15		
30	P0.17	P0.17	20	SIO_17		



BL651 Pin #	BL651 Pin Name	nRF52810 QFN Name	nRF52810 QFN Pin#	BL652 Equivalent Pin Name	Notes	Comment
31	P0.19	P0.19	22	SIO_19		
32	P0.31/AIN7	P0.31/AIN7	43	SIO_31/AIN7		
33	P0.30/AIN6	P0.30/AIN6	42	SIO_30/AIN6		
34	P0.29/AIN5	P0.29/AIN5	41	SIO_29/AIN5		
35	P0.28/AIN4	P0.28/AIN4	40	SIO_28/AIN4		
36	P0.27/I2C_SCL	P0.27	39	SIO_27/I2C_SCL	Pin Definitions <a href="#">Note 1</a>	
37	P0.26/I2C_SDA	P0.26	38	SIO_26/I2C_SDA	Pin Definitions <a href="#">Note 1</a>	
38	P0.25/SPI_CLK	P0.25	37	SIO_25/SPI_CLK	Pin Definitions <a href="#">Note 1</a>	
39	GND	-	-	GND		-

**Pin Definition Notes:**

- Note 1** The BL651 module PIO pins to which UART, I2C, and SPI interfaces are mapped, are those found on the Nordic development board as well as the BL652 development board. You can bring out UART, I2C, and SPI on any pins allowed by Nordic within the user developed application.
- Note 2** SWD (two-wire interface), pin 5 (SWDIO) and pin 6 (SWDCLK).  
*We recommend that you use SWD (2-wire interface) to handle customer developed BL651 module firmware upgrades. You MUST wire out the SWD (2-wire interface) on your host design (see [Figure 4](#), where four lines should be wired out, namely SWDIO, SWDCLK, GND and VCC).*
- Note 3** Pull the nRESET pin (pin 7) low for a minimum of 100 milliseconds to reset the BL651.
- Note 4** Not required for BL651 module normal operation. Nordic SDK examples by default assume that the external 32.768 kHz crystal is connected. You must modify the Nordic SDK example to reflect if the external 32.768 kHz crystal is fitted or not. The on-chip 32.768 kHz RC oscillator provides the standard accuracy of ±500 ppm, with calibration required at least every eight seconds to stay within ±500 ppm.  
  
BL651 also allows the option of connecting an external higher accuracy (±20 ppm) 32.768 kHz crystal to the BL651 pins SIO\_01/XL2 (pin 24) and SIO\_00/XL1 (pin 25). This provides higher accuracy protocol timing and helps with radio power consumption in the SYSTEM ON IDLE or SYSTEM OFF modes by reducing the time that the Rx window must be open.

### 3.3 Electrical Specifications

#### 3.3.1 Absolute Maximum Ratings

Absolute maximum ratings for supply voltage and voltages on digital and analogue pins of the module are listed in [Table 3](#). Exceeding these values causes permanent damage.

**Table 3: Maximum current ratings**

Parameter	Min	Max	Unit
Voltage at VDD_nRF pin	-0.3	+3.9 (Maximum Ratings <a href="#">Note 1</a> )	V
Voltage at GND pin		0	V

Parameter	Min	Max	Unit
Voltage at GPIO pin (at $VDD_{nRF} \leq 3.6V$ )	-0.3	$VDD_{nRF} + 0.3$	V
Voltage at GPIO pin (at $VDD_{nRF} \geq 3.6V$ )	-0.3	3.9	V
Radio RF input level	-	10	dBm
<b>Environmental</b>			
Storage temperature	-40	+85	°C
MSL (Moisture Sensitivity Level)	-	4	-
ESD (as per EN301-489)			
Conductive		4	KV
Air Coupling		8	KV
Flash Memory (Endurance) (Maximum Ratings <a href="#">Note 2</a> )	-	10000	Write/erase cycles
Flash Memory (Retention)	-	10 years at 40°C	-

**Maximum Ratings Notes:**

- Note 1** The absolute maximum rating for VCC pin (max) is 3.9V for the BL651.
- Note 2** Standard wear levelling techniques can be used to increase the lifetime of the module.

### 3.3.2 Recommended Operating Parameters

**Table 4: Power supply operating parameters**

Parameter	Min	Typ	Max	Unit
$VDD_{nRF}$ (independent of DCDC) (Recommended Operating Parameters <a href="#">Note 1</a> )	1.7	3.0	3.6	V
VCC Maximum ripple or noise (Recommended Operating Parameters <a href="#">Note 2</a> )	-	-	10	mV
VCC rise time (0 to 1.7V) (Recommended Operating Parameters <a href="#">Note 3</a> )	-	-	60	mS
Operating Temperature Range	-40	-	+85	°C

**Recommended Operating Parameters Notes:**

- Note 1** 4.7 uF internal to module on VCC.
- Note 2** This is the maximum VCC ripple or noise (at any frequency) that does not disturb the radio.
- Note 3** The on-board power-on reset circuitry may not function properly for rise times outside the noted interval.

**Table 5: Signal levels for digital IO interfaces**

Parameter	Min	Typ	Max	Unit
$V_{IH}$ Input high voltage	$0.7 VDD_{nRF}$		$VDD_{nRF}$	V
$V_{IL}$ Input low voltage	VSS		$0.3 \times VDD_{nRF}$	V
$V_{OH}$ Output high voltage				
(standard drive, 0.5 mA, $VDD_{nRF} \geq 1.7V$ )	$VDD_{nRF} - 0.4$		$VDD_{nRF}$	V
(high-drive, 3 mA, $VDD_{nRF} \geq 1.7V$ )	$VDD_{nRF} - 0.4$		$VDD_{nRF}$	V
(high-drive, 5 mA, $VDD_{nRF} \geq 2.7V$ )	$VDD_{nRF} - 0.4$		$VDD_{nRF}$	V
$V_{OL}$ Output low voltage				
(standard drive, 0.5 mA, $VDD_{nRF} \geq 1.7V$ )	VSS		$VSS + 0.4$	V

Parameter	Min	Typ	Max	Unit
(high-drive, 3 mA, VDD_nRF≥1.7V)	VSS		VSS+0.4	V
(high-drive, 5 mA, VDD_nRF≥2.7V)	VSS		VSS+0.4	
V <sub>OL</sub> Current at VSS+0.4V, output set low				
(standard drive, 0.5 mA, VDD_nRF≥1.7V)	1	2	4	mA
(high-drive, 3 mA, VDD_nRF≥1.7V)	3	-	-	mA
(high-drive, 5 mA, VDD_nRF≥2.7V)	6	10	15	mA
V <sub>OL</sub> Current at VDD_nRF -0.4, output set high				
(standard drive, 0.5mA, VDD_nRF≥1.7V)	1	2	4	mA
(high-drive, 3mA, VDD_nRF≥1.7V)	3	-	-	mA
(high-drive, 5mA, VDD_nRF≥2.7V)	6	9	14	mA
Pull up resistance	11	13	16	kΩ
Pull down resistance	11	13	16	kΩ
Pad capacitance		3		pF

**Table 6: AIN (ADC) specification**

Parameter	Min	Typ	Max	Unit
ADC Internal reference voltage	-1.5%	0.6 V	+1.5%	%
ADC pin input internal selectable scaling		4, 2, 1, 1/2, 1/3, 1/4, 1/5 1/6		scaling
ADC input pin (AIN) voltage maximum without damaging ADC w.r.t (Recommended Operating Parameters <a href="#">Note 1</a> )				
<b>VCC</b>	<b>Prescaling</b>	VDD_nRF + 0.3		V
0V-VDD_nRF	4, 2, 1, ½, 1/3, ¼, 1/5, 1/6			
Configurable	8-bit mode	10-bit mode	12-bit mode	bits
Acquisition Time, source resistance ≤10 kΩ Acquisition Time, source resistance ≤40 kΩ				
		3		µs
Acquisition Time, source resistance ≤100 kΩ				
		5		µs
Acquisition Time, source resistance ≤100 kΩ				
		10		µs
Acquisition Time, source resistance ≤200 kΩ				
		15		µs
Acquisition Time, source resistance ≤400 kΩ				
		20		µs
Acquisition Time, source resistance ≤800 kΩ				
		40		µs
Acquisition Time, source resistance ≤800 kΩ				
Conversion Time <sup>3</sup>		<2		µs
ADC input impedance (during operation) (Recommended Operating Parameters <a href="#">Note 3</a> )				
		>1		MΩ
Input Resistance		2.5		pF
Sample and hold capacitance at				

Parameter	Min	Typ	Max	Unit
maximum gain				

**Recommended Operating Parameters Notes:**

- Note 1** Stay within internal 0.6 V reference voltage with given pre-scaling on AIN pin and do not violate ADC maximum input voltage (for damage) for a given VCC, e.g. If VCC is 3.6V, you can only expose AIN pin to VDD+0.3 V.
- Note 2** Through customer firmware the resolution (8-bit, 10-bit, or 12-bit mode or oversample 14-bit) and acquisition time is configurable. The sampling frequency is limited by the sum of sampling time and acquisition time. The maximum sampling time is 2us. For acquisition time of 3us the total conversion time is 5us, which makes maximum sampling frequency of  $1/5\mu s = 200$  kHz. Similarly, if acquisition time of 40us chosen, then the conversion time is 42us and the maximum sampling frequency is  $1/42\mu s = 23.8$  kHz
- Note 3** ADC input impedance is estimated mean impedance of the ADC (AIN) pins.

## 4 POWER CONSUMPTION

VCC\_nRF of 3.0 V with internal (to chipset) LDO ON or with internal (to chipset) DCDC ON (see Power Consumption [Note 1](#)) and 25°C.

### 4.1 Power Consumption

**Table 7: Power consumption**

Parameter	Min	Typ	Max	Unit
<b>Active mode 'peak' current</b> (Power Consumption <a href="#">Note 1</a> )		With DCDC [with LDO]		
<b>(Advertising or Connection)</b>		7.0 [15.4]		mA
Tx only run peak current @ Txpwr = +4 dBm		4.6 [10.1]		mA
Tx only run peak current @ Txpwr = 0 dBm		3.6 [7.8]		mA
Tx only run peak current @ Txpwr = -4 dBm		3.2 [6.8]		mA
Tx only run peak current @ Txpwr = -8 dBm		2.9 [6.2]		mA
Tx only run peak current @ Txpwr = -12 dBm		2.7 [5.7]		mA
Tx only run peak current @ Txpwr = -16 dBm		2.5 [5.4]		mA
Tx only run peak current @ Txpwr = -20 dBm		2.1 [4.3]		mA
Tx only run peak current @ Txpwr = -40 dBm				
<b>Active Mode</b> (Power Consumption <a href="#">Note 1</a> )				
Rx only 'peak' current		4.6 [10.0]		mA
<b>Ultra-low Power Mode 1</b> (Power Consumption <a href="#">Note 2</a> )				
System ON IDLE + 24kB RAM retention, wake on any event + LFRC		1.5		uA
<b>Ultra-low Power Mode 2</b> (Power Consumption <a href="#">Note 3</a> )				
System OFF (no RAM retention, wake on any event)		300		nA
<b>Active Mode Average current</b>				
<b>Advertising Average Current draw</b>				
<b>Max</b> , with advertising interval (min) 20 mS		(Power Cons. <a href="#">Note 4</a> )		uA
<b>Min</b> , with advertising interval (max) 10240 mS		(Power Cons. <a href="#">Note 4</a> )		uA
<b>Connection Average Current draw</b>				
<b>Max</b> , with connection interval (min) 7.5 mS		(Power Cons. <a href="#">Note 4</a> )		uA
<b>Min</b> , with connection interval (max) 4000 mS		(Power Cons. <a href="#">Note 4</a> )		uA

#### Power Consumption Notes:

- Note 1** This is for Peak Radio Current only, but there is additional current due to the MCU. The use of the internal DCDC convertor or LDO is decided by the underlying BLE stack.
- Note 2** BL651: System ON IDLE current is 1.5 uA typical. System ON IDLE is entered automatically through a command in the customer-developed firmware. In System ON IDLE, all enabled peripherals remain on and may re-awaken the chip. Depending on active peripherals, current consumption ranges from ~1.5 uA to 270 uA (when UART is ON). See individual peripherals current consumption data in the [Peripheral Block Current Consumption](#) section. Through customers FW development, functionality to detect GPIO change with no current consumption cost, it is possible to close the UART and get to the 1.5uA current consumption regime and still detect incoming data and be woken up so that the UART can be re-opened at expense of losing that first character.

The BL651 System ON IDLE current consists of the below nRF52810 blocks:

- nRF52 System ON IDLE current (no RAM retention) (1.2 uA) – This is the base current of the CPU
- LFRC (0.6 uA) and RTC (0.1uA) running as well as 24 k RAM retention (0.2 uA) – This adds to the total of 1.5 uA typical.

**Note 3** In System OFF, everything is disabled and the only wake-up sources are reset and changes on GPIO on which sense is enabled. The current consumption is ~300 nA typical in BL651.

- Hardware reset to come out of System OFF.
- Can come out from System OFF to System ON IDLE through GPIO signal through the reset vector.

**Note 4** Average current consumption depends on several factors (including Tx power, VCC, accuracy of 32 MHz and 32.768 kHz), all peripherals off (UART OFF after radio event), slave latency of 0 (in a connection). With these factors fixed, the largest variable is the advertising or connection interval set.

Advertising Interval range:

- 20 milliseconds to 10240 milliseconds (10485759.375 mS in BT5.0) in multiples of 0.625 milliseconds.

For an advertising event:

- The minimum average current consumption is when the advertising interval is large 10240 milliseconds (10485759.375 mS - in BT5.0) although this may cause long discover times (for the advertising event) by scanners
  - The maximum average current consumption is when the advertising interval is small 20 mS
- Other factors that are also related to average current consumption include the advertising payload bytes in each advertising packet and whether it's continuously advertising or periodically advertising.

Connection Interval range (for a peripheral device):

- 7.5 milliseconds to 4000 milliseconds in multiples of 1.25 milliseconds.

For a connection event (for a peripheral device):

- The minimum average current consumption is when the connection interval is large 4000 milliseconds
- The maximum average current consumption is with the shortest connection interval of 7.5 ms; no slave latency.

Other factors that are also related to average current consumption include:

- Number of packets per connection interval with each packet payload size
- An inaccurate 32.768 kHz master clock accuracy would increase the average current consumption.

## 4.2 Peripheral Block Current Consumption

The following values are calculated for a typical operating voltage of 3V.

**Table 8: UART power consumption**

Parameter	Min	Typ	Max	Unit
UART Run current @ 115200 bps	-	55	-	uA
UART Run current @ 1200 bps	-	55	-	uA
Idle current for UART (no activity)	-	1	-	uA
UART Baud rate	1.2	-	1000	kbps

**Table 9: Power consumption**

Parameter	Min	Typ	Max	Unit
-----------	-----	-----	-----	------

SPI Master Run current @ 2 Mbps	-	50	-	uA
SPI Master Run current @ 8 Mbps	-	50	-	uA
SPI bit rate	0.125	-	8	Mbps

**Table 10: I2C power consumption**

Parameter	Min	Typ	Max	Unit
I2C Run current @ 100 kbps	-	50	-	uA
I2C Run current @ 400 kbps	-	50	-	uA
I2C Bit rate	100	-	400	kbps

**Table 11: ADC power consumption**

Parameter	Min	Typ	Max	Unit
ADC current during conversion	-	700	-	uA

The above current consumption is for the given peripheral only; to operate that peripheral requires some other internal blocks which consume base current. This base current is consumed when the UART, SPI, I2C, or ADC is opened (operated).

For asynchronous interface like the UART (asynchronous as the other end can communicate at any time), the UART on the BL651 must be kept open (by a command in customers application), resulting in the base current consumption penalty.

For a synchronous interface like the I2C or SPI, the interface can be closed and opened only when needed, resulting in current saving (no base current consumption penalty). There's a similar argument for ADC (open ADC when needed).

## 5 FUNCTIONAL DESCRIPTION

The BL651 BLE (Bluetooth Low Energy) module is a self-contained product and requires only power and a user's application to implement full BLE functionality. The integrated, high performance PCB trace antenna combined with the RF and base-band circuitry provides the BLE wireless link, and any of the GPIO lines provide the OEM's chosen interface connection to the sensors.

BL651 module hardware is functionally capable as the nRF52810 chipset used in the module design and Table 12 shows the nRF52810 features list from Nordic Documentation <http://infocenter.nordicsemi.com/index.jsp>. For details, refer to the nRF52810 datasheet

[http://infocenter.nordicsemi.com/topic/com.nordic.infocenter.nrf52/dita/nrf52/chips/nrf52810.html?cp=2\\_2](http://infocenter.nordicsemi.com/topic/com.nordic.infocenter.nrf52/dita/nrf52/chips/nrf52810.html?cp=2_2)

**Table 12: nRF52810 features**

Features	nRF52810
CPU	Cortex M4 (no FPU) 64 MHz
Memory	192 kB flash 24 kB RAM No cache
Easy DMA MAXCNT bit length	PDM 15 PWM 15 Radio 8 SAADC 15 SPIM 10 SPIS 10 TWIM 10 TWIS 10 UARTE 10
Crypto	AES engine

Features	nRF52810
Clock	32 MHz crystal (onboard BL651) 64 MHz on-chip PLL 32.768 kHz crystal (optional and external to BL651) 32.768 kHz on-chip RC External 32.768 kHz clock
Power Management	One stage LDO and DCDC
Digital Interfaces	One SPI master and slave One TWI master and slave One UARTE One PWM QDEC PDM
Analog Interfaces	64-level Analog Comp 8-channel 12-bit ADC True Random Number Generator
Timers	Three 32-bit 16-MHz timers Two 32.768 kHz RTC Watchdog timer (32.768 kHz)
Other Interfaces	Four GPIOTEs SWI debug interface
PPI	20 programmable channels 12 fixed channels Six channel groups
Other Features	BPROT (Block Protection) Six SWI Two EGU
Power Fail	Power fail comparator and brownout
GPIO	Up to 32 pins Eight GPIOTEs channels

To provide the widest scope for integration, a variety of physical host interfaces/sensors are provided. The major BL651 series module functional blocks described in the following section.

## 5.1 Power Management (includes Brown-out and Power on Reset)

Power management features:

- System ON IDLE and System OFF modes
- Open/Close peripherals (UART, SPI, I2C, GPIO's, ADC). Peripherals consume current when open; each peripheral can be individually closed to save power consumption
- Use of the internal DCDC convertor or LDO is decided by the underlying BLE stack
- VCC voltage to be read (through the internal ADC)
- Pin wake-up system from deep sleep

Power supply features:

- Supervisor hardware to manage power during reset, brownout, or power fail
- 1.7V to 3.6V supply range using internal DCDC convertor or LDO decided by the underlying BLE stack



## 5.2 Clocks and Timers

### 5.2.1 Clocks

The integrated high accuracy 32 MHz ( $\pm 10$  ppm) crystal oscillator helps with radio operation and reducing power consumption in the active modes.

The integrated on-chip 32.768 kHz RC oscillator ( $\pm 500$  ppm) provides protocol timing and helps with radio power consumption in the system StandByDoze and Deep Sleep modes by reducing the time that the RX window must be open.

To keep the on-chip 32.768 kHz RC oscillator within  $\pm 500$  ppm (which is needed to run the BLE stack) accuracy, the RC oscillator must be calibrated (which takes 16-17 milliseconds) regularly. The default calibration interval is at least eight seconds which is enough to keep within  $\pm 500$  ppm. The calibration interval ranges from 0.25 seconds to 31.75 seconds (in multiples of 0.25 seconds).

### 5.2.2 Timers

- **Regular Timer** – There are five built-in timers (regular timers) derived from a single RTC clock; the resolution of the regular timer is 976 microseconds.
- **Tick Timer (Counter)** – A 31-bit free running counter that increments every (one) millisecond. The resolution of this counter is 488 microseconds.

## 5.3 Memory

The nRF52810 has 192 kBytes Flash and 24 kB RAM.

## 5.4 Radio Frequency (RF)

- 2402–2480 MHz Bluetooth Low Energy radio BT5.0 (1 Mbps and 2 Mbps over-the-air data rate)
- Tx output power of +4 dBm programmable to -20 dBm in steps of 4 dB and further down -40 dBm
- Receiver (with integrated channel filters) to achieve maximum sensitivity -96 dBm @ 1 Mbps BLE and 93 dBm @ 2 Mbps BLE.
- RF conducted interface available in the following two ways:
  - 453-00005: RF connected to on-board PCB trace antenna
  - 453-00006: RF connected to on-board IPEX MH4 RF connector
- Antenna options:
  - Integrated monopole PCB trace antenna on the 453-00005
  - External dipole antenna connected with to IPEX MH4 RF connector on the 453-00006
- Received Signal Strength Indicator (RSSI):
  - RSSI accuracy (valid range -90 dBm to -20 dBm) is  $\pm 2$  dB typical
  - RSSI resolution 1 dB typical
  - Sample period 0.25  $\mu$ s

## 5.5 UART Interface

The Universal Asynchronous Receiver/Transmitter offers fast, full-duplex, asynchronous serial communication with built-in flow control support (UART\_CTS, UART\_RTS) in hardware up to one Mbps baud.

UART\_TX, UART\_RX, UART\_RTS, and UART\_CTS form a conventional asynchronous serial data port with handshaking. The interface is designed to operate correctly when connected to other UART devices such as the 16550A. The signaling levels are nominal 0 V and 3.3 V (tracks VCC) and are inverted with respect to the signaling on an RS232 compliant cable.

Two-way hardware flow control is implemented by UART\_RTS and UART\_CTS. UART\_RTS is an output and UART\_CTS is an input. Both are active low.

These signals operate according to normal industry convention. UART\_RX, UART\_TX, UART\_CTS, UART\_RTS are all 3.3 V level logic (tracks VCC). For example, when RX and TX are idle, they sit at 3.3 V. Conversely, for handshaking pins CTS, RTS at 0 V is treated as an assertion.

The module communicates with the customer application using the following signals:

- Port/TxD of the application sends data to the module’s UART\_RX signal line
- Port/RxD of the application receives data from the module’s UART\_TX signal line

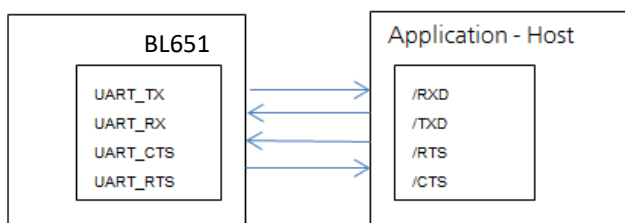

Figure 3: UART signals

**Note:** The BL651 serial module output is at 3.3V CMOS logic levels (tracks VCC). Level conversion must be added to interface with an RS-232 level compliant interface.

Some serial implementations link CTS and RTS to remove the need for handshaking. We do not recommend linking CTS and RTS other than for testing and prototyping. If these pins are linked and the host sends data at the point that the BL651 de-asserts its RTS signal, then there is significant risk that internal receive buffers will overflow. This could lead to an internal processor crash which would drop the connection and may require a power cycle to reset the module. We recommend that the correct CTS/RTS handshaking protocol be adhered to for proper operation.

The BL651 module PIO pins to which the UART interface is mapped are those found on the Nordic development board as well as the BL652 development board. You can bring out UART on any pins allowed by Nordic within the user application.

Table 13: UART interface

BL651 Signal Name	BL651 Pin Number	I/O	Comments
P0.06 / UART_Tx	19	O	P0.06 (alternative function UART_Tx) is an output, set high (in customers application via Nordic SDK)
P0.08 / UART_Rx	17	I	P0.08 (alternative function UART_Rx) is an input, set with internal pull-up (in customers application via Nordic SDK)
P0.05 / UART_RTS	20	O	P0.05 (alternative function UART_RTS) is an output, set low (in customers application via Nordic SDK)
P0.07 / UART_CTS	18	I	P0.07 (alternative function UART_CTS) is an input, set with internal pull-down (in customers application via Nordic SDK)

## 5.6 SPI Bus

The SPI interface is an alternate function on GPIO pins.

The module can be a master device (or slave device) that uses terminals SPI\_MOSI, SPI\_MISO, and SPI\_CLK. SPI\_CS is implemented using any spare SIO digital output pins to allow for multi-dropping. Each multidrop SPI slave device requires a unique and dedicated SPI\_CS line.

The SPI interface enables full duplex synchronous communication between devices. It supports a 3-wire (SPI\_MOSI, SPI\_MISO, SPI\_SCK) bi-directional bus with fast data transfers to and from multiple slaves. Individual chip select signals are necessary for each of the slave devices attached to a bus, but control of these is left to the application through use of SIO signals. I/O data is double-buffered.

The SPI peripheral supports SPI mode 0, 1, 2, and 3.

**Table 14: SPI interfaces**

BL651 Signal Name	BL651 Pin No	I/O	Comments
P0.23/SPI_MOSI	3	O	
P0.24/SPI_MISO	2	I	This interface is an alternate function.
P0.25/SPI_CLK	38	O	
Any_P0.xx/SPI_CS	4	I	

SPI\_CS is implemented using any spare SIO digital output pins to allow for multi-dropping. On Laird BL652 devboard, SIO\_22 (pin 4) is used as SPI\_CS.

The BL651 module PIO pins to which the SPI interface is mapped are those found on the Nordic development board as well as the BL652 development board. You can bring out SPI on any pins allowed by Nordic within the user application.

## 5.7 I2C Interface

The I2C interface is an alternate function on GPIO pins.

The two-wire interface can interface a bi-directional wired-OR bus with two lines (SCL, SDA) and has master/slave topology. Data rates of 100 kbps and 400 kbps are supported along with 250 kbps for master only. The interface is capable of clock stretching.

An I2C interface allows multiple masters and slaves to communicate over a shared wired-OR type bus consisting of two lines which normally sit at VCC. The BL651 module can only be configured as an I2C master or slave. The SCL is the clock line which is always sourced by the master; and SDA is a bi-directional data line which can be driven by any device on the bus.

**IMPORTANT:** It is essential to remember that pull-up resistors on both SCL and SDA lines are not provided in the module and MUST be provided external to the module.

**Table 15: I2C interface**

BL651 Signal Name	BL651 Pin No	I/O	Comments
P0.26/I2C_SDA	37	I/O	This interface is an alternate function on each pin
P0.27/I2C_SCL	36	I/O	

The BL651 module PIO pins to which the I2C interface is mapped are those found on the Nordic development board as well as the BL652 dev board. You can bring out I2C on any pins allowed by Nordic within the user application.

## 5.8 General Purpose I/O, ADC, PWM, and FREQ

### 5.8.1 GPIO

The 19 GPIO pins are user-configured features:

- Input/output direction
- Output drive strength (standard drive 0.5 mA or high drive 3 or 5 mA –depends on VDD\_nRF)
- Internal pull-up and pull-down resistors (13 K Ohms typical) or no pull-up/down
- Wake-up from high or low-level triggers on all pins
- Input buffer disconnect
- Analog input (for selected pins)

### 5.8.2 ADC

The ADC is an alternate function on dedicated GPIO pins.

The BL651 provides access to 8-channel 8/10/12-bit successive approximation ADC in one-shot mode. This enables sampling up to eight external signals through a front-end MUX. The ADC has configurable input and reference pre-scaling and sample resolution (8, 10, and 12 bit).

#### 5.8.2.1 Analog Interface (ADC)

**Table 16: Analog interface**

BL651 Signal Name	BL651 Pin No	I/O	Comments
P0.05/UART_RTS/AIN3 – Analog Input	20	I	This interface is an alternate function on each pin
P0.04/AIN2 – Analog Input	21	I	Configurable 8-, 10-, 12-bit resolution
P0.03/AIN1 – Analog Input	22	I	Configurable voltage scaling
P0.02/AIN0 – Analog Input	23	I	4, 2, 1/1, 1/3, 1/3, 1/4, 1/5, 1/6
P0.31/AIN7 – Analog Input	32	I	Configurable acquisition time
P0.30/AIN6 – Analog Input	33	I	3 uS, 5 uS, 10 uS, 15 uS, 20 uS, 40 uS
P0.29/AIN5 – Analog Input	34	I	
P0.28/AIN4 – Analog Input	35	I	Full scale input range (VCC)

### 5.8.3 PWM Signal Output on SIO Pins

The PWM output is an alternate function on GPIO pins.

The PWM output signal has a frequency and duty cycle property. Frequency is adjustable (up to one MHz) and the duty cycle can be set over a range from 0% to 100%

PWM output signal has a frequency and duty cycle property. PWM output is generated using dedicated hardware in the chipset. There is a trade-off between PWM output frequency and resolution.

For example:

- PWM output frequency of 500 kHz (2 uS) results in resolution of 1:2
- PWM output frequency of 100 kHz (10 uS) results in resolution of 1:10
- PWM output frequency of 10 kHz (100 uS) results in resolution of 1:100
- PWM output frequency of 1 kHz (1000 uS) results in resolution of 1:1000

## 5.9 nRESET pin

**Table 17: nRESET pin**

BL651 Signal Name	BL651 Pin Number	I/O	Comments
nRESET	7	I	BL651 HW reset (active low). Pull the nRESET pin low for minimum 100 mS in order for the BL651 to reset.

## 5.10 Two-wire Interface SWD

You can use the two-wire (SWD) interface for application programming and debugging.

**Table 18: Two-wire interface SWD**

BL651 Signal Name	BL651 Pin Number	I/O	Comments
SWDIO	5	I/O	Internal pull-up resistor
SWDCLK	6	I	Internal pull-down resistor

There is also the following JTAG connector which allows on-board JTAG J-link programmer signals to be routed off the development board. The only requirement is that you should use the following JTAG connector on the host PCB.

Table 19 shows the SWD connector MPN:

**Table 19: SWD connector MPN**

Reference	Part	Description and MPN (Manufacturers Part Number)
JP1	FTSH-105	Header, 1.27mm, SMD, 10-way, FTSH-105-01-L-DV Samtech

**Note:** Reference on the BL652 development board schematic ([Figure 4](#)) shows the DVK-BL652 development schematic wiring only for the SWD connector and the BL651 module SWD pins.

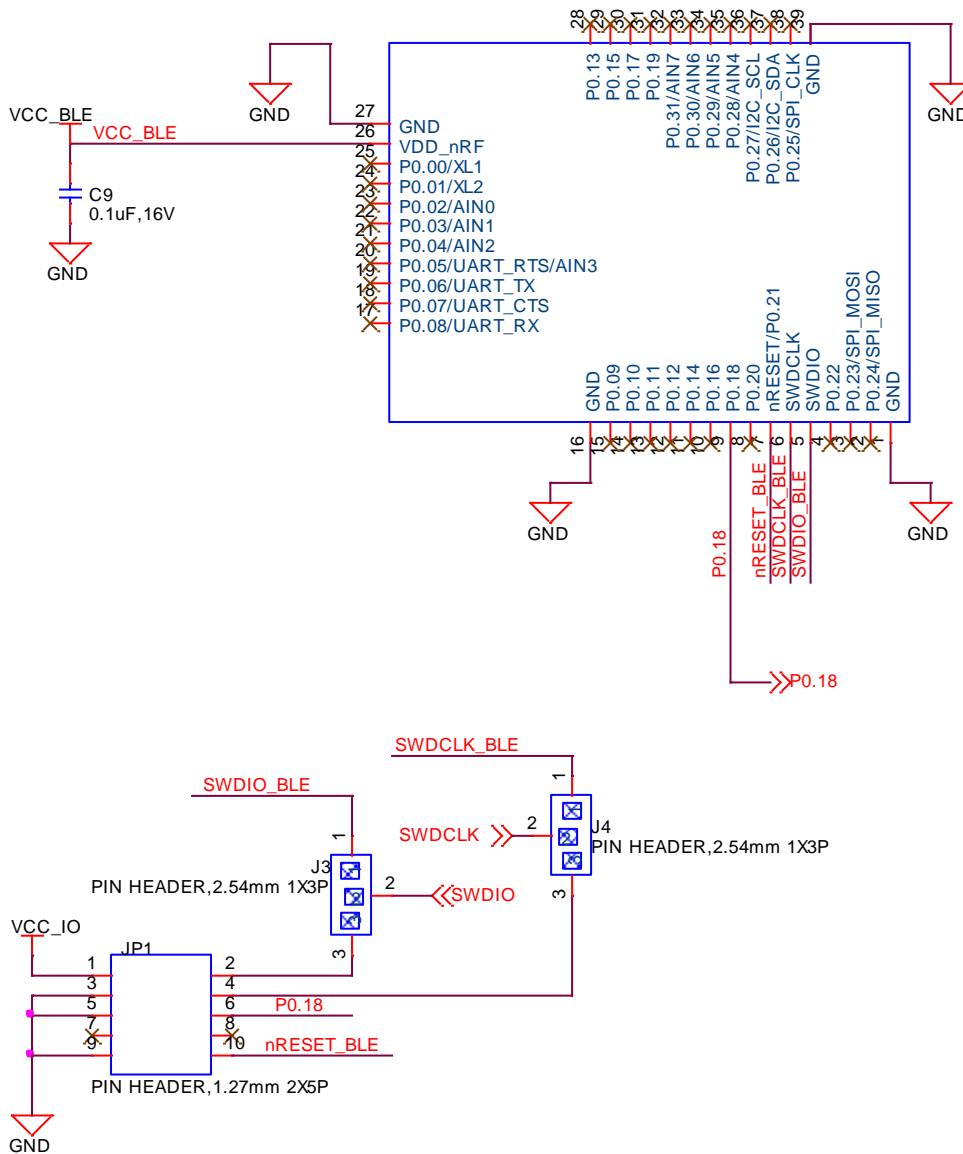

Figure 4: BL652 development board schematic

We recommend that you use SWD (2-wire interface) to handle customer developed BL651 module firmware upgrades. You MUST wire out the SWD (2-wire interface) on your host design (see Figure 4, where four lines should be wired out, namely SWDIO, SWDCLK, GND and VCC).

P0.18 is a trace output (called SWO, Serial Wire Output) and is not necessary for programming the BL651 over the SWD interface.

nReset\_BLE is not necessary for programming the BL651 over the SWD interface.

## 5.11 BL651 Wakeup

### 5.11.1 Waking Up BL651 from Host

Wake the BL651 from the host using wake-up pins (any PIO pin). You may configure the BL651's wakeup pins in the customer's application to do any of the following:

- Wake up when signal is low
- Wake up when signal is high
- Wake up when signal changes

## 5.12 Low Power Modes

The BL651 has three power modes: Run (Active), Standby Doze (SYSTEM ON IDLE), and Deep Sleep (SYSTEM OFF). The module wakes from Standby Doze via any interrupt (such as a received character on the UART Rx line). If the module receives a UART character from either the external UART or the radio, it wakes up. Deep sleep is the lowest power mode. Once awakened, the system goes through a system reset.

## 5.13 Temperature Sensor

The on-silicon temperature sensor has a temperature range greater than or equal to the operating temperature of the device with accuracy  $\pm 5^{\circ}\text{C}$ . Resolution is  $0.25^{\circ}\text{C}$ .

## 5.14 Security/Privacy

### 5.14.1 AES Encryption/Decryption

Exposed via Nordic SDK functions, refer to Nordic documentation.

### 5.14.2 Readback Protection

Exposed via Nordic SDK functions, refer to Nordic documentation.

The BL651 supports readback protection capability that disallows the reading of the memory on the nRF52810 using a JTAG interface.

### 5.14.3 Elliptic Curve Cryptography

Exposed via Nordic SDK functions, refer to Nordic documentation.

The BL651 offers a range of functions for generating public/private keypair, calculating a shared secret, as well as generating an authenticated hash.

## 5.15 Optional External 32.768 kHz Crystal

This is not required for normal BL651 module operation. Nordic SDK examples by default assume that the external 32.768 kHz crystal is connected. The customer must modify the Nordic SDK example to reflect whether or not the external 32.768 kHz crystal is fitted.

The BL651 uses the on-chip 32.76 kHz RC oscillator (LFCLK) by default (which has an accuracy of  $\pm 500$  ppm); this requires regulator calibration (at least every eight seconds) to within  $\pm 500$  ppm.

You can connect an optional external high accuracy ( $\pm 20$  ppm) 32.768 kHz crystal to the BL651 pins, P0.01/XL2 (pin 24) and P0.00/XL1 (pin 25) to provide improved protocol timing and to help with radio power consumption in the system standby/doze/deep sleep modes by reducing the time that the RX window needs to be open. [Table 20](#) compares the current consumption difference between RC and crystal oscillator.

**Table 20: Current consumption difference between BL651 on-chip RC 32.76 kHz oscillator and optional external crystal (32.768 kHz) based oscillator**

	BL651 On-chip 32.768 kHz RC Oscillator (±500 ppm) LFRC	Optional External Higher Accuracy (±20 ppm) 32.768 kHz Crystal-based Oscillator XO
<b>Current Consumption of 32.768 kHz Block</b>	0.6 uA	0.25 uA
<b>Standby Doze Current (System ON IDLE+24k RAM retention+RTC+LFRC)</b>	1.5 uA	2.0 uA
<b>Calibration</b>	<p>Calibration is required regularly (default eight seconds interval) Calibration takes 16-17 ms; with DCDC used, the total charge of a calibration event is 7.4 uC. The average current consumed by the calibration depends on the calibration interval and can be calculated using the following formula: <b>CAL_charge/CAL_interval</b></p> <p>The lowest calibration interval (0.25 seconds) provides an average current of (DCDC enabled): <b>7.4uC / 0.25s = 29.6uA</b></p> <p>To get the 500-ppm accuracy, the BLE stack specification states that a calibration interval of eight seconds is enough. This gives an average current of: <b>7.4uC/8s = 0.93 uA</b></p> <p>Added to the LFRC run current and Standby Doze (IDLE) base current shown above results in a total average current of: <b>LFRC + CAL = 1.5 + 0.93 = 2.43uA</b></p>	Not applicable
<b>Total</b>	2.43 uA	1.45 uA
<b>Summary</b>	<ul style="list-style-type: none"> <li>Low current consumption</li> <li>Accuracy 500 ppm</li> </ul>	<ul style="list-style-type: none"> <li>Lowest current consumption</li> <li>Needs external crystal</li> <li>High accuracy (depends on the crystal, usually 20 ppm)</li> </ul>

**Table 21: Optional external 32.768 kHz crystal specification**

Optional external 32.768kHz crystal	Min	Typ	Max
Crystal Frequency	-	32.768 kHz	-
Frequency tolerance requirement of BLE stack	-	-	±250 ppm
Load Capacitance	-	-	12.5 pF
Shunt Capacitance	-	-	2 pF
Equivalent series resistance	-	-	100 kOhm
Drive level	-	-	1 uW
Input capacitance on XL1 and XL2 pads	-	4 pF	-
Run current for 32.768 kHz crystal based oscillator	-	0.25 uA	-
Startup time for 32.768 kHz crystal based oscillator	-	0.25 seconds	-
Peak to peak amplitude for external low swing clock input signal must not be outside supply rails	200 mV	-	1000 mV



Be sure to tune the load capacitors on the board design to optimize frequency accuracy (at room temperature) so it matches that of the same crystal standalone, Drive Level (so crystal operated within safe limits) oscillation margin ( $R_{neg}$  is at least 3 to 5 times ESR) over the operating temperature range.

## 5.16 453-00005 On-board PCB Trace Antenna Characteristics

The 453-00005 on-board PCB trace monopole antenna radiated performance depends on the host PCB layout.

A Laird internal BL651 development board was used for BL651 development and antenna performance evaluation. To obtain similar performance, follow guidelines in section [PCB Layout on Host PCB for 453-00005](#) to allow the on-board PCB trace antenna to radiate and reduce proximity effects due to nearby host PCB GND copper or metal covers.

**Table 22: Antenna radiation performance**

Unit in dBi @2.44GHz	XY-plane		XZ-plane		YZ-plane	
	Peak	Avg	Peak	Avg	Peak	Avg
453-00005 module on-board PCB Trace antenna	-0.21	-3.95	-1.69	-8.1	-4.06	-6.4

◆XY-plane

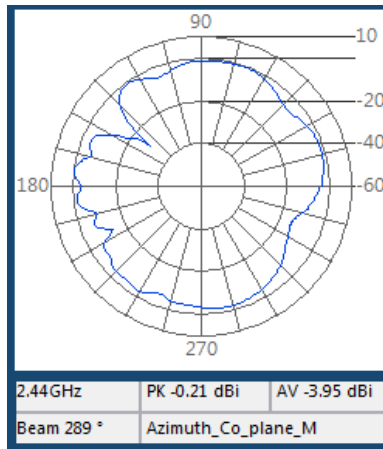

◆XZ-plane

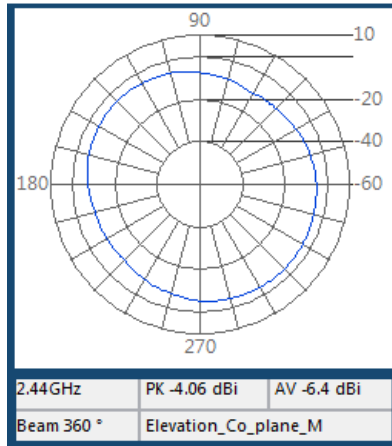

◆YZ-plane

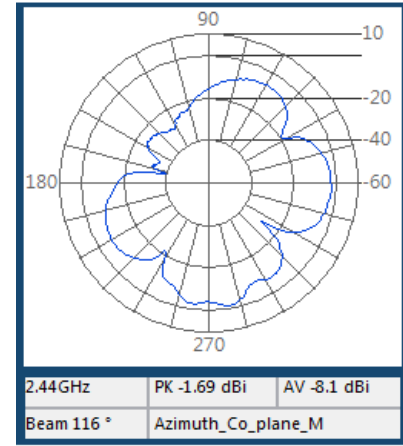

Figure 5: Trace antenna performance

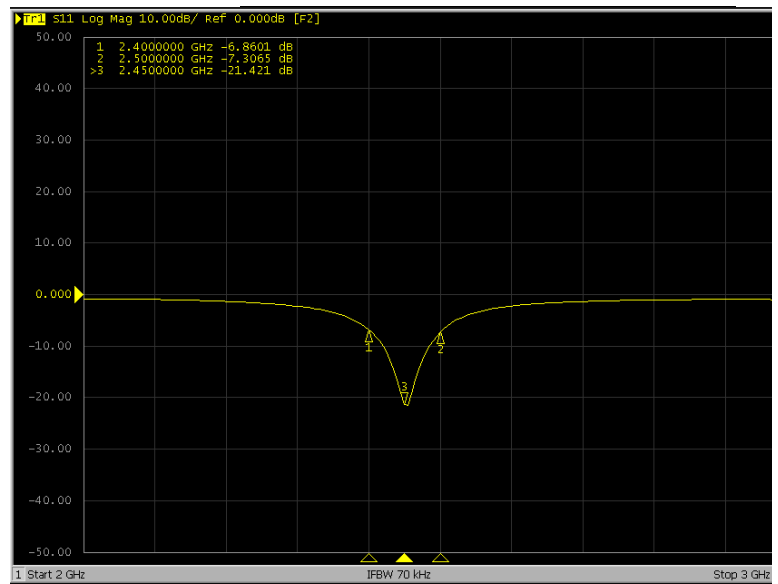
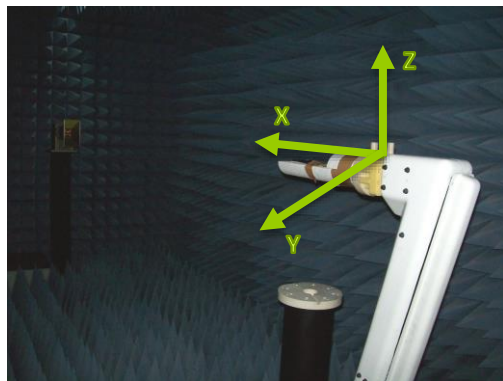

Figure 6: 453-00005 on-board PCB Trace antenna performance (Antenna Gain, efficiency and S11 (whilst 453-00005 module on DVK-BL652-xx development board)

## 6 HARDWARE INTEGRATION SUGGESTIONS

### 6.1 Circuit

The BL651 is easy to integrate, requiring no external components on your board apart from those which you require for development and in your end application.

The following are suggestions for your design for the best performance and functionality.

#### Checklist (for Schematic):

- **VCC pins**  
External power source should be within the operating range, rise time and noise/ripple specification of the BL651. Add decoupling capacitors for filtering the external source. Power-on reset circuitry within BL651 series module incorporates brown-out detector, thus simplifying your power supply design. Upon application of power, the internal power-on reset ensures that the module starts correctly.
- **VCC and coin-cell operation**  
With built-in DCDC (operating range 1.7V to 3.6V), reduces the peak current required from a coin-cell, making it easier to use with coin-cell.
- **AIN (ADC) and GPIO pin IO voltage levels**  
BL651 GPIO voltage levels are at VCC. Ensure input voltage levels into GPIO pins are at VCC also (if VCC source is a battery whose voltage will drop). Ensure ADC pin maximum input voltage for damage is not violated.
- **AIN (ADC) impedance and external voltage divider setup**  
If you need to measure with ADC a voltage higher than 3.6V, you can connect a high impedance voltage divider to lower the voltage to the ADC input pin.
- **SWD**  
We recommend that use SWD (2-wire interface) to handle customer developed BL651 module firmware upgrades. You MUST wire out the JTAG (2-wire interface) on your host design (see [Figure 4](#), where four lines should be wired out, namely SWDIO, SWDCLK, GND and VCC).
- **UART**  
Add connector to allow interfacing with UART via PC (UART-RS232 or UART-USB). Laird recommends flow control to prevent UART data loss.
- **I2C**  
It is essential to remember that pull-up resistors on both I2C\_SCL and I2C\_SDA lines are not provided in the BL651 module and MUST be provided external to the module as per I2C standard.
- **SPI**  
Implement SPI chip select using any unused GPIO pin within customers application then SPI\_CS is controlled from customers application allowing multi-dropping.
- **GPIO pin direction**  
BL651 modules shipped from production are un-programmed. Remember to change the direction GPIO pin (in customer developed application) if that particular pin is wired to a device that expects to be driven by the BL651 GPIO pin configured as an output. Also, these GPIO pins if used as inputs have the internal pull-up or pull-down resistor. To avoid floating inputs which can cause current consumption in low power modes (e.g. System ON IDLE) to drift with time; customer can enable the PULL-UP or PULL-DOWN through their application.

---

**Note:** Internal pull-up, pull down will take current from VCC.

---

- **nRESET pin (active low)**  
Hardware reset. Wire out to push button or drive by host.  
By default module is out of reset when power applied to VCC pins.
- **Optional External 32.768kHz crystal**

If the optional external 32.768kHz crystal is needed then use a crystal that meets specification. Nordic SDK examples by default assume external 32.768kHz crystal is connected. Customer must modify Nordic SDK example to reflect if external 32.768kHz crystal is fitted or not.

## 6.2 PCB Layout on Host PCB - General

### Checklist (for PCB):

- You MUST locate the BL651 module close to the edge of PCB (mandatory for 453-00005 for on-board PCB trace antenna to radiate properly).
- Use solid GND plane on inner layer (for best EMC and RF performance).
- All module GND pins MUST be connected to host PCB GND.
- Place GND vias as close to module GND pads as possible.
- Unused PCB area on surface layer can be flooded with copper but place GND vias regularly to connect copper flood to inner GND plane. If GND flood copper underside the module then connect with GND vias to inner GND plane.
- Route traces to avoid noise being picked up on VCC supply and AIN (analogue) and SIO (digital) traces.
- Ensure no exposed copper is on the underside of the module (refer to Figure 10 land pattern of BL652 development board).

## 6.3 PCB Layout on Host PCB for 453-00005

### 6.3.1 Antenna Keep-out on Host PCB

The 453-00005 has an integrated PCB trace antenna and its performance is sensitive to host PCB. It is critical to locate the 453-00005 on the edge of the host PCB (or corner) to allow the antenna to radiate properly. Refer to guidelines in the [PCB land pattern and antenna keep-out area for 453-00005](#) section. Some of those guidelines repeated below.

- Ensure there is no copper in the antenna keep-out area on any layers of the host PCB. Keep all mounting hardware and metal clear of the area to allow proper antenna radiation.
- For best antenna performance, place the 453-00005 module on the edge of the host PCB, preferably the edge center.
- The BL651 development board (not commercially available) has the 453-00005 module on the edge of the board (preferably the edge center). The antenna keep-out area is defined by the BL651 development board which was used for module development and antenna performance evaluation is shown in [Figure 7](#), where the antenna keep-out area is ~4.95mm wide, 25.65 mm long; with PCB dielectric (no copper) height 0.85 mm sitting under the 453-00005 PCB trace antenna.
- The 453-00005 PCB trace antenna is tuned when 453-00005 module is sitting on development board (host PCB) with size of 120 mm x 93 mm.
- A different host PCB thickness dielectric will have a small effect on antenna.
- The antenna-keep-out defined in the [Host PCB Land Pattern and Antenna Keep-out for 453-00005](#) section.
- Host PCB land pattern and antenna keep-out for the BL651 applies when the 453-00005 is placed in the edge of the host PCB, preferably the edge center. [Figure 7](#) shows an example.

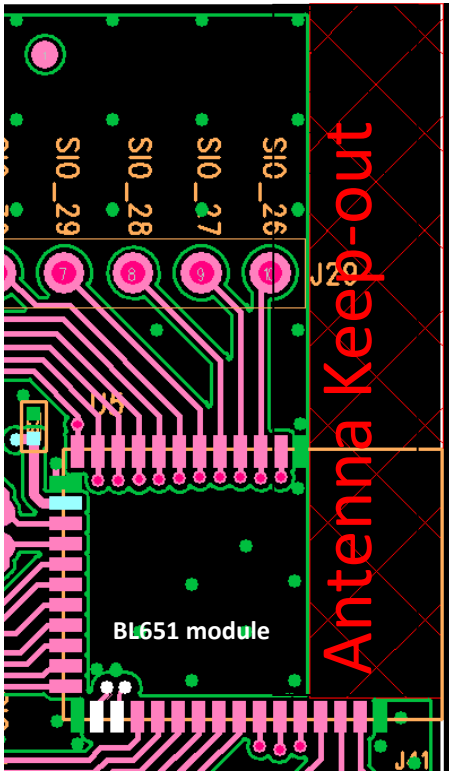

Figure 7: Antenna keep-out area (shown in red), corner of the BL651 development board for 453-00005 module.

#### Antenna Keep-out Notes:

- Note 1** The BL651 module is placed on the edge of the host PCB, preferably edge center of the host PCB.
- Note 2** Copper cut-away on all layers in the *Antenna Keep-out* area under 453-00005 on host PCB.

### 6.3.2 Antenna Keep-out and Proximity to Metal or Plastic

#### Checklist (for metal /plastic enclosure):

- Minimum safe distance for metals without seriously compromising the antenna (tuning) is 40 mm top/bottom and 30 mm left or right.
- Metal close to the 453-00005 PCB trace monopole antenna (bottom, top, left, right, any direction) will have degradation on the antenna performance. The amount of that degradation is entirely system dependent, meaning you must perform some testing with your host application.
- Any metal closer than 20 mm begins to significantly degrade performance (S11, gain, radiation efficiency).
- It is best that you test the range with a mock-up (or actual prototype) of the product to assess effects of enclosure height (and materials, whether metal or plastic) and host PCB size (ground plane size).

## 6.4 External Antenna Integration with 453-00006

Please refer to the regulatory sections for [FCC](#), [IC](#), [CE](#), and [Japan](#) for details of use of BL651 (453-00006) with external antennas in each regulatory region.

The BL651 family is designed to operate with the following external antennas (with a maximum gain of 2.0 dBi). The required antenna impedance is 50 ohms. See [Table 23](#). External antennas improve radiation efficiency.

**Table 23: External antennas for the BL651**

Manufacturer	Model	Laird Part Number	Type	Connector	Peak Gain	
					2400-2480 MHz	2400-2500 MHz
Laird	NanoBlue	EBL2400A1-10MH4L	PCB Dipole	IPEX MHF4		2 dBi
Laird	FlexPIFA	001-0022	PCB Dipole	IPEX MHF4	2 dBi	
Mag.Layers	EDA-8709-2G4C1-B27-CY	0600-00057	Dipole	IPEX MHF4		2 dBi
Laird	mFlexPIFA	EFA2400A3S-10MH4L	PIFA	IPEX MHF4	2 dBi	

**Note 1:** Integral RF co-axial cable with length 100 ±5 mm and MHF4 compatible connector.  
These antennas are available through Laird, Mouser, or Digikey.

## 7 MECHANICAL DETAILS

### 7.1 BL651 Mechanical Details

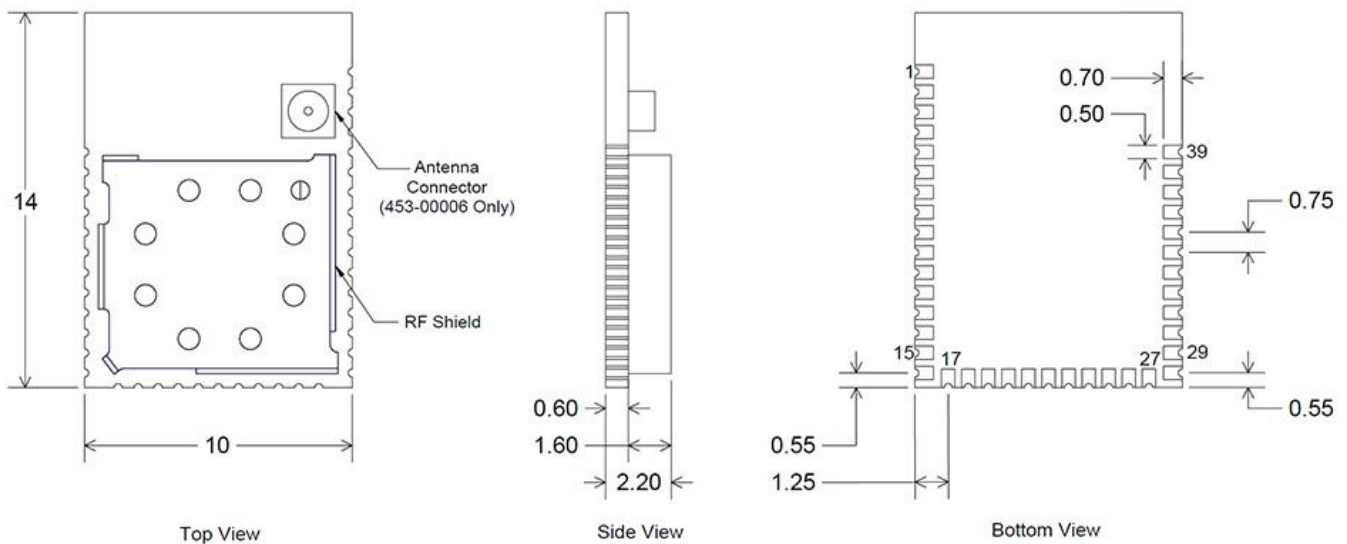

#### Tolerances

Board Outline: +/- 0.13mm  
PCB Thickness: +/- 0.1mm

**Figure 8: BL651 mechanical drawings**

## 7.2 Host PCB Land Pattern and Antenna Keep-out for 453-00005

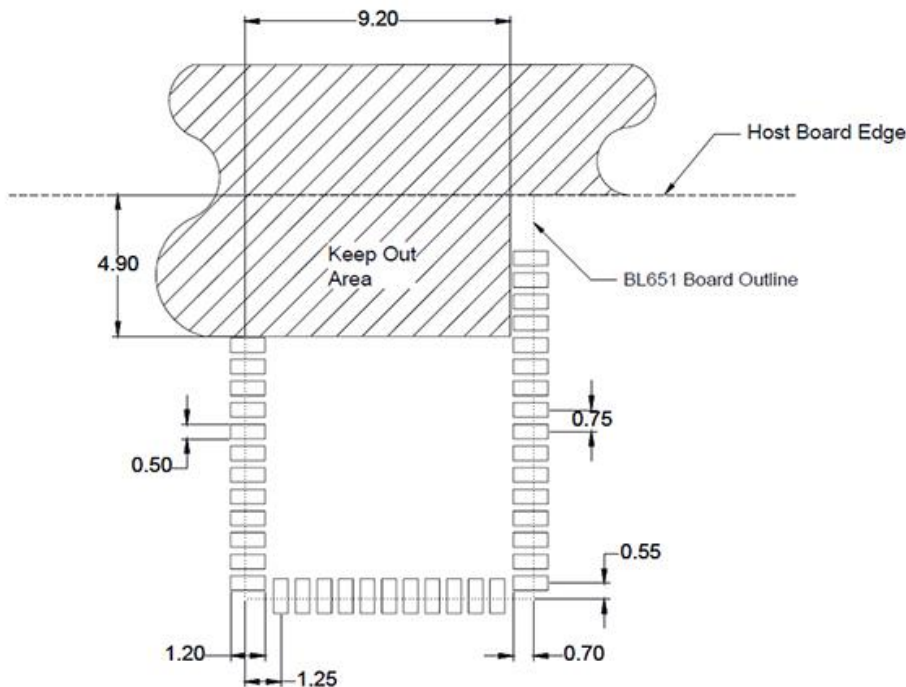

**Figure 9: Land pattern and Keep-out for 453-00005**

All dimensions are in millimeters (mm).

### Host PCB Land Pattern and Antenna Keep-out for 453-00005 Notes:

- Note 1** Ensure there is no copper in the antenna *keep out area* on any layers of the host PCB. Also keep all mounting hardware or any metal clear of the area (Refer to 6.3.2) to reduce effects of proximity detuning the antenna and to help antenna radiate properly.
- Note 2** For the best on-board antenna performance, the module 453-00005 **MUST** be placed on the edge of the host PCB and preferably in the edge centre of host PCB, the antenna *keep out area* is extended (see Note 4).
- Note 3** BL651 development board has 453-00005 placed on the edge of the PCB board (and not in corner) for that the Antenna keep out area is extended down to the corner of the development board, see the [PCB Layout on Host PCB for 453-00005](#) section. This was used for module development and antenna performance evaluation.
- Note 4** Ensure that there is no exposed copper under the module on the host PCB.
- Note 5** You may modify the PCB land pattern dimensions based on their experience and/or process capability.

## 8 APPLICATION NOTE FOR SURFACE MOUNT MODULES

### 8.1 Introduction

Laird Technologies' surface mount modules are designed to conform to all major manufacturing guidelines. This Application Note section is considered a living document and will be updated as new information is presented.

The modules are designed to meet the needs of several commercial and industrial applications. They are easy to manufacture and conform to current automated manufacturing processes.

### 8.2 Shipping

#### 8.2.1 Tape and Reel Package Information

**Note:** The Laird part numbers for BL651 modules – 453-00005 and 453-00006 are for Tape and Reel packaging in 1k unit reels. The addition of a 'C' at the end of the part number denotes Cut Tape option.

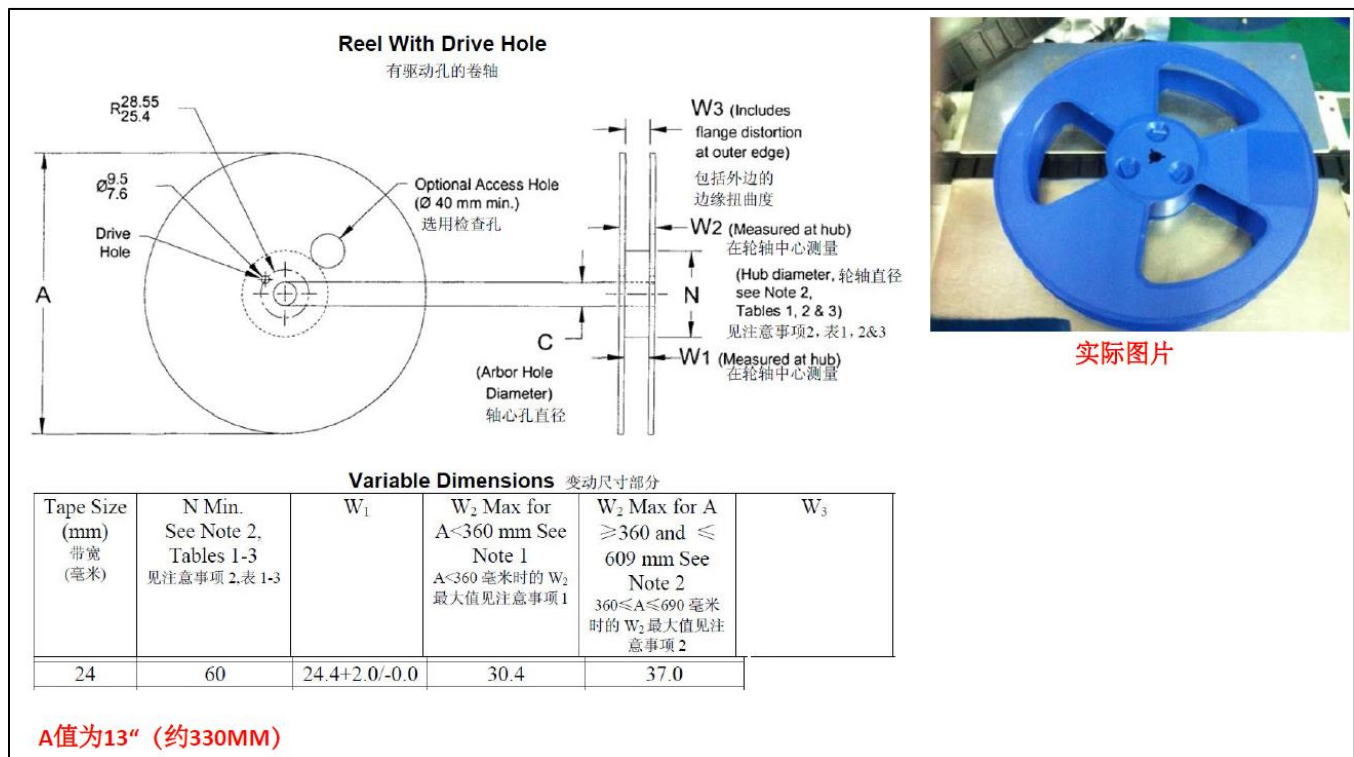
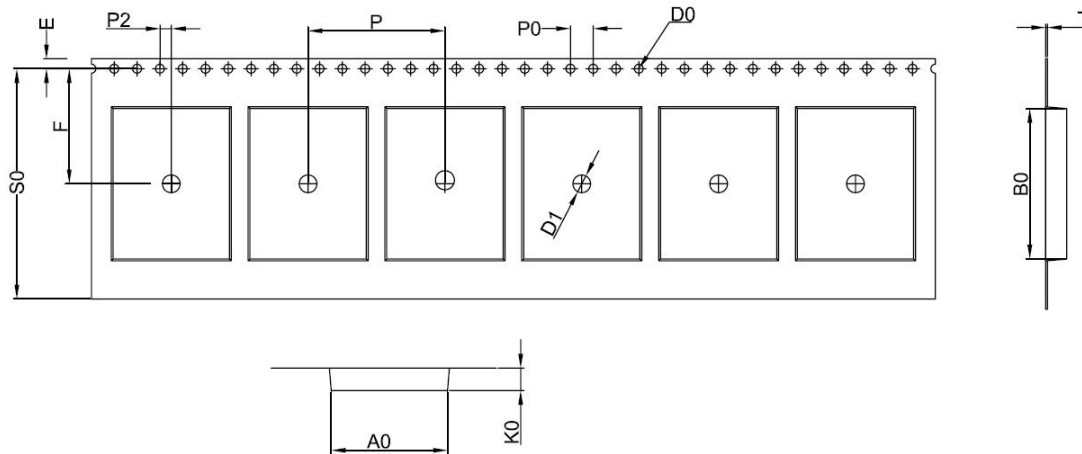

Figure 10: Reel specifications



ITRM	W	A0	B0	K0	K1	P	F	E	S0	D0	D1	P0	P2	T	13" 环保卷靴	
DIM	24.00	10.30	14.30	2.40	--	16.00	11.50	1.75	22.25	1.50	1.50	4.00	2.00	0.35	长度/盘	元件/盘
TOL	+0.30 -0.30	+0.30 -0.0	+0.30 -0.0	+0.20 -0.00	+0.10 -0.10	+0.10 -0.10	+0.10 -0.10	+0.10 -0.10	+0.10 -0.10	+0.10 -0.00	+0.10 -0.00	+0.10 -0.10	+0.10 -0.10	+0.05 -0.05	25M	1000pcs



- 备注: (1)任意10个脚轮的累计误差不得超过 $\pm 0.20\text{mm}$ 。  
 (2)载带长度方向100mm距离的非平行度不得超过1mm。超过250mm不计算累计误差。  
 (3)非指明公差范围为:  $\pm 0.20\text{mm}$ 。  
 (4)A0, B0为型腔内底部尺寸, K0为内部尺寸。  
 (5)材料厚度T以在载带边缘测量为准, 须打中孔。  
 (6)材质黑色防静电。

Title <b>BL651 Shipping Tape</b>		
P/N: 45Y728-00100	Rev 1	
Drawn by <b>WZR</b>	Date 7-Jul-2016	Sheet <b>1/1</b>

Figure 11: Tape specifications

There are 1000 pieces of BL651 modules taped in a reel (and packaged in a pizza box) and five boxes per carton (5000 modules per carton). Reel, boxes, and carton are labeled with the appropriate labels. See [Carton Contents](#) for more information.

## 8.2.2 Carton Contents

The following are the contents of the carton shipped for the BL651 modules.



PCBA: 5000  
pcs/ctn

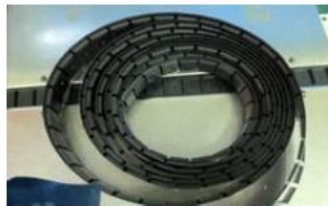

Tape: 1000 pcs PCBA/roll, 5 rolls/ctn



Reel: 5 pcs/ctn



Bag: 5 pcs/ctn

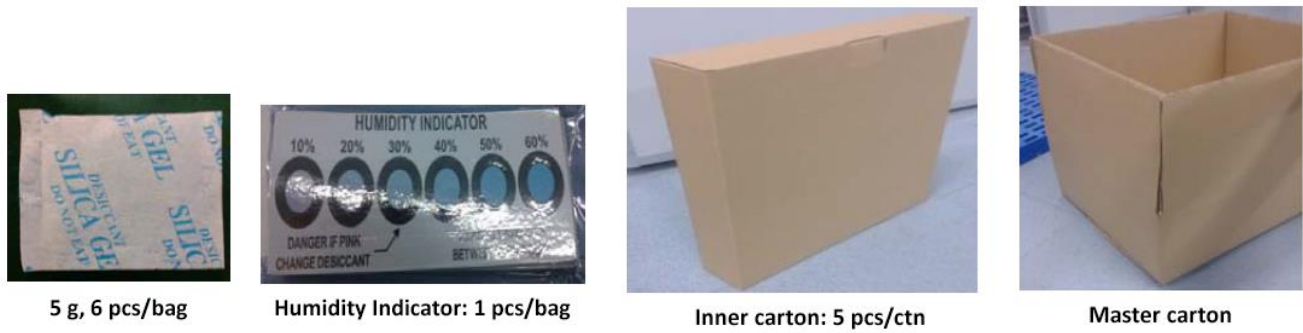

Figure 12: Carton contents for the BL651

### 8.2.3 Packaging Process

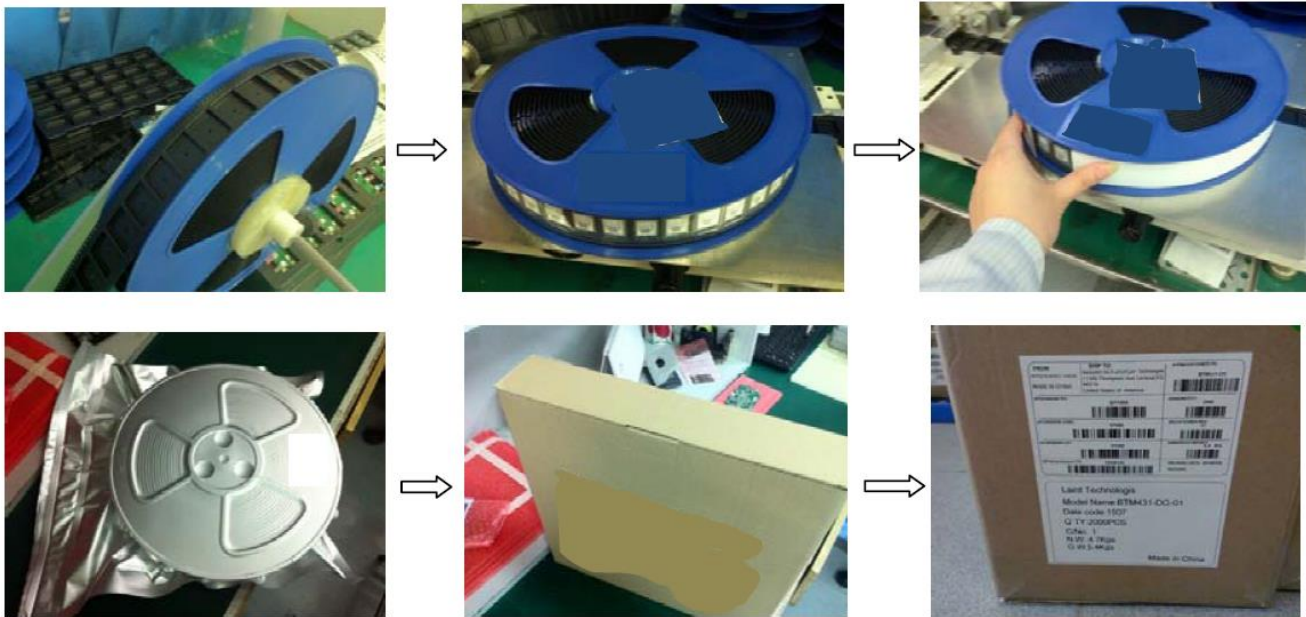

Figure 13: BL651 packaging process

### 8.2.4 Labeling

The following labels are located on the antistatic bag:



Figure 14: Antistatic bag labels

The following package label is located on both sides of the master carton:

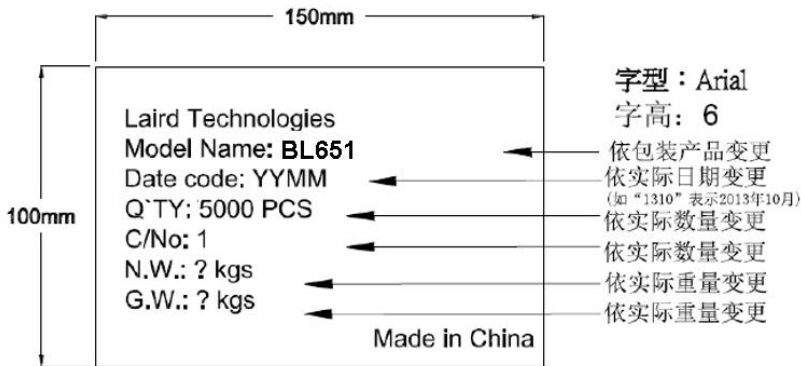

Figure 15: Master carton package label

The following is the packing slip label:

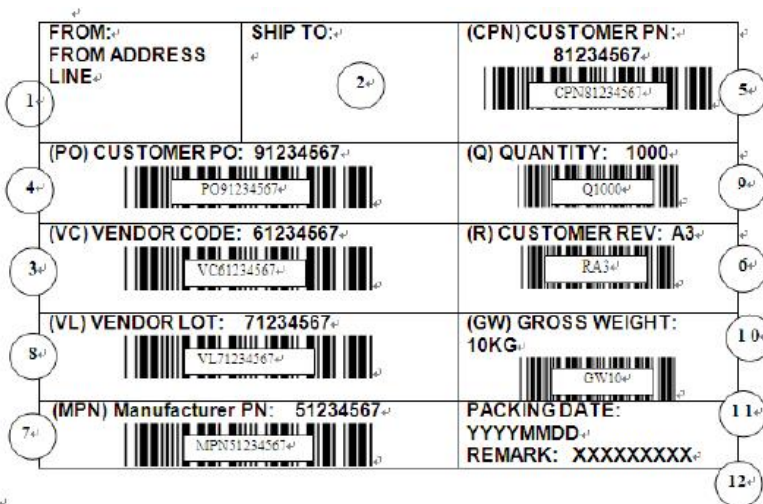

Figure 16: Packing slip label

## 8.3 Reflow Parameters

Prior to any reflow, it is important to ensure the modules were packaged to prevent moisture absorption. New packages contain desiccant (to absorb moisture) and a humidity indicator card to display the level maintained during storage and shipment. If directed to *bake units* on the card, see [Table 24](#) and follow instructions specified by IPC/JEDEC J-STD-033. A copy of this standard is available from the JEDEC website: <http://www.jedec.org/sites/default/files/docs/jstd033b01.pdf>

**Note:** The shipping tray cannot be heated above 65°C. If baking is required at the higher temperatures displayed in [Table 24](#), the modules must be removed from the shipping tray.

Any modules not manufactured before exceeding their floor life should be re-packaged with fresh desiccant and a new humidity indicator card. Floor life for MSL (Moisture Sensitivity Level) 4 devices is 168 hours in ambient environment ≤30°C/60%RH.

**Table 24: Recommended baking times and temperatures**

MSL	125 °C Baking Temp.		90 °C/≤ 5%RH Baking Temp.		40 °C/ ≤ 5%RH Baking Temp.	
	Saturated @ 30 °C/85%	Floor Life Limit + 72 hours @ 30 °C/60%	Saturated @ 30 °C/85%	Floor Life Limit + 72 hours @ 30 °C/60%	Saturated @ 30 °C/85%	Floor Life Limit + 72 hours @ 30 °C/60%
3	9 hours	7 hours	33 hours	23 hours	13 days	9 days

Laird surface mount modules are designed to be easily manufactured, including reflow soldering to a PCB. Ultimately it is the responsibility of the customer to choose the appropriate solder paste and to ensure oven temperatures during reflow meet the requirements of the solder paste. Laird surface mount modules conform to J-STD-020D1 standards for reflow temperatures.

**Important:** During reflow, modules should not be above 260° and not for more than 30 seconds.

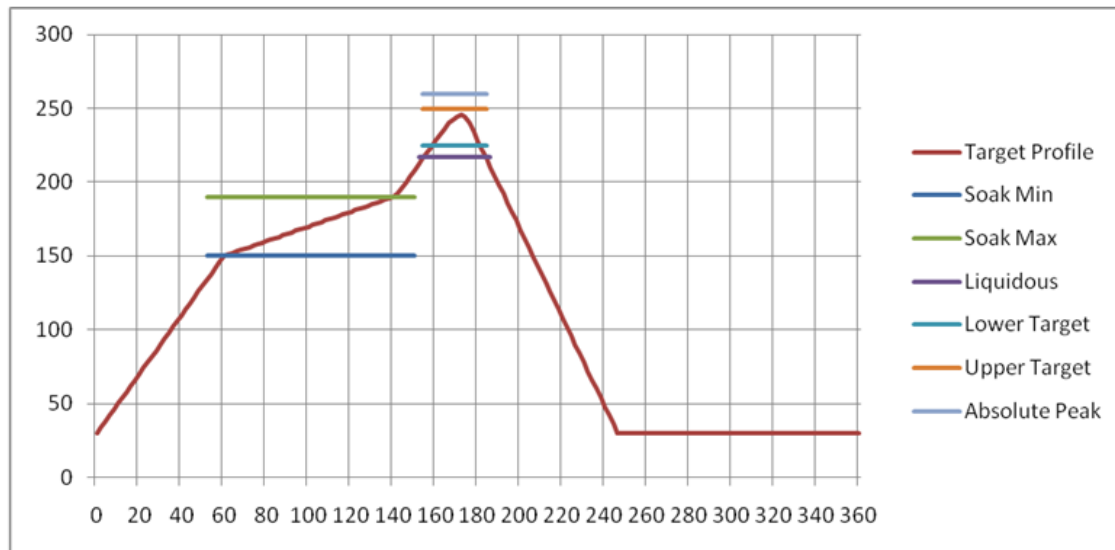

**Figure 17: Recommended reflow temperature**

Temperatures should not exceed the minimums or maximums presented in [Table 25](#).

**Table 25: Recommended maximum and minimum temperatures**

Specification	Value	Unit
Temperature Inc./Dec. Rate (max)	1~3	°C / Sec
Temperature Decrease rate (goal)	2-4	°C / Sec
Soak Temp Increase rate (goal)	.5 - 1	°C / Sec
Flux Soak Period (Min)	70	Sec
Flux Soak Period (Max)	120	Sec
Flux Soak Temp (Min)	150	°C
Flux Soak Temp (max)	190	°C
Time Above Liquidous (max)	70	Sec
Time Above Liquidous (min)	50	Sec
Time In Target Reflow Range (goal)	30	Sec
Time At Absolute Peak (max)	5	Sec

Specification	Value	Unit
Liquidous Temperature (SAC305)	218	°C
Lower Target Reflow Temperature	240	°C
Upper Target Reflow Temperature	250	°C
Absolute Peak Temperature	260	°C

## 9 FCC AND IC REGULATORY

Model	US/FCC	Canada/IC
453-00005	SQGBL651	3147A-BL651
453-00006	SQGBL651	3147A-BL651

The BL651 Series hold full modular approvals. The OEM must follow the regulatory guidelines and warnings listed below to inherit the modular approval.

Part #	Form Factor	Tx Outputs	Antenna
453-00005	Surface Mount	4 dBm	PCB Trace
453-00006	Surface Mount	4 dBm	IPEX MHF4

\*Last two slots "XX" in Part # are used for production firmware release changes. Can be values 01-99, aa-zz

### 9.1 Antenna Information

The BL651 family has been designed to operate with the antennas listed below with a maximum gain of 2 dBi. The required antenna impedance is 50 ohms.

Manufacturer	Model	Laird Part Number	Type	Connector	Peak Gain	
					2400-2480 MHz	2400-2500 MHz
Laird	NanoBlue	EBL2400A1-10MH4L	PCB Dipole	IPEX MHF4	2 dBi	
Laird	FlexPIFA	001-0022	PCB Dipole	IPEX MHF4	2 dBi	
Mag.Layers	EDA-8709-2G4C1-B27-CY	0600-00057	Dipole	IPEX MHF4	2 dBi	
Laird	mFlexPIFA	EFA2400A3S-10MH4L	PIFA	IPEX MHF4	2 dBi	
Laird	453-00005 PCB printed antenna	NA	Printed PCB	N/A	0 dBi	

**Note:** The OEM is free to choose another vendor's antenna of like type and equal or lesser gain as an antenna appearing in the table and still maintain compliance. Reference FCC Part 15.204(c)(4) for further information on this topic.

To reduce potential radio interference to other users, the antenna type and gain should be chosen so that the equivalent isotropic radiated power (EIRP) is not more than that permitted for successful communication.



## 9.2 Power Exposure Information

Federal Communication Commission (FCC) Radiation Exposure Statement:

This EUT is in compliance with SAR for general population/uncontrolled exposure limits in ANSI/IEEE C95.1-1999 and had been tested in accordance with the measurement methods and procedures specified in OET Bulletin 65 Supplement C.

This transceiver must not be co-located or operating in conjunction with any other antenna, transmitter, or external amplifiers. Further testing / evaluation of the end product will be required if the OEM's device violates any of these requirements.

The BL651 is fully approved for mobile and portable applications.

## 9.3 OEM Responsibilities

---

**WARNING:** The OEM must ensure that FCC labelling requirements are met. This includes a clearly visible label on the outside of the OEM enclosure specifying the appropriate Laird Technology FCC identifier for this product.

Contains FCC ID: SQGBL651 IC: 3147A-BL651

If the size of the end product is larger than 8x10cm, then the following FCC part 15.19 statement has to also be available on visible on outside of device:

The enclosed device complies with Part 15 of the FCC Rules. Operation is subject to the following two conditions: (1) This device may not cause harmful interference, and (2) This device must accept any interference received, including interference that may cause undesired operation

---

Label and text information should be in a size of type large enough to be readily legible, consistent with the dimensions of the equipment and the label. However, the type size for the text is not required to be larger than eight point.

**CAUTION:** The OEM should have their device which incorporates the BL651 tested by a qualified test house to verify compliance with FCC Part 15 Subpart B limits for unintentional radiators.

**CAUTION:** Any changes or modifications not expressly approved by Laird Technology could void the user's authority to operate the equipment.

## 9.4 Federal Communication Commission Interference Statement

This equipment has been tested and found to comply with the limits for a Class B digital device, pursuant to Part 15 of the FCC Rules. These limits are designed to provide reasonable protection against harmful interference in a residential installation. This equipment generates, uses and can radiate radio frequency energy and, if not installed and used in accordance with the instructions, may cause harmful interference to radio communications. However, there is no guarantee that interference will not occur in a particular installation. If this equipment does cause harmful interference to radio or television reception, which can be determined by turning the equipment off and on, the user is encouraged to try to correct the interference by one of the following measures:

- Reorient or relocate the receiving antenna.
- Increase the separation between the equipment and receiver.
- Connect the equipment into an outlet on a circuit different from that to which the receiver is connected.
- Consult the dealer or an experienced radio/TV technician for help.

**FCC Caution:** Any changes or modifications not expressly approved by the party responsible for compliance could void the user's authority to operate this equipment.

This device complies with Part 15 of the FCC Rules. Operation is subject to the following two conditions: (1) This device may not cause harmful interference, and (2) this device must accept any interference received, including interference that may cause undesired operation.

#### **IMPORTANT NOTE**

##### **FCC Radiation Exposure Statement**

The product complies with the US portable RF exposure limit set forth for an uncontrolled environment and are safe for intended operation as described in this manual. The further RF exposure reduction can be achieved if the product can be kept as far as possible from the user body or set the device to lower output power if such function is available.

This transmitter must not be co-located or operating in conjunction with any other antenna or transmitter.

##### **This device is intended only for OEM integrators under the following condition:**

1. The transmitter module may not be co-located with any other transmitter or antenna,

As long as the condition above is met, further transmitter testing is not required. However, the OEM integrator is still responsible for testing their end-product for any additional compliance requirements required with this module installed

#### **IMPORTANT NOTE**

In the event that these conditions cannot be met (for example certain laptop configurations or co-location with another transmitter), then the FCC authorization is no longer considered valid and the FCC ID cannot be used on the final product. In these circumstances, the OEM integrator is responsible for re-evaluating the end product (including the transmitter) and obtaining a separate FCC authorization.

##### **End Product Labeling**

The final end product must be labeled in a visible area with the following: "Contains FCC ID: SQGBL651".

##### **Manual Information to the End User**

The OEM integrator must be aware not to provide information to the end user regarding how to install or remove this RF module in the user's manual of the end product which integrates this module.

The end user manual shall include all required regulatory information/warning as show in this manual.

## **9.5 Industry Canada Statement**

This device complies with Industry Canada's license-exempt RSSs. Operation is subject to the following two conditions:

- (1) This device may not cause interference; and
- (2) This device must accept any interference, including interference that may cause undesired operation of the device.

Le présent appareil est conforme aux CNR d'Industrie Canada applicables aux appareils radio exempts de licence. L'exploitation est autorisée aux deux conditions suivantes:

- (1) l'appareil ne doit pas produire de brouillage;
- (2) l'utilisateur de l'appareil doit accepter tout brouillage radioélectrique subi, même si le brouillage est susceptible d'en compromettre le fonctionnement.

##### **Radiation Exposure Statement**

The product complies with the Canada portable RF exposure limit set forth for an uncontrolled environment and are safe for intended operation as described in this manual. The further RF exposure reduction can be achieved if the product can be kept as far as possible from the user body or set the device to lower output power if such function is available.

##### **Déclaration d'exposition aux radiations:**

Le produit est conforme aux limites d'exposition pour les appareils portables RF pour les Etats-Unis et le Canada établies pour un environnement non contrôlé. Le produit est sûr pour un fonctionnement tel que décrit dans ce manuel. La

réduction aux expositions RF peut être augmentée si l'appareil peut être conservé aussi loin que possible du corps de l'utilisateur ou que le dispositif est réglé sur la puissance de sortie la plus faible si une telle fonction est disponible.

This device is intended only for OEM integrators under the following conditions:

(1) The transmitter module may not be co-located with any other transmitter or antenna.

As long as 1 condition above are met, further transmitter test will not be required. However, the OEM integrator is still responsible for testing their end-product for any additional compliance requirements required with this module installed.

**Cet appareil est conçu uniquement pour les intégrateurs OEM dans les conditions suivantes:**

(1) Le module émetteur peut ne pas être coïmplanté avec un autre émetteur ou antenne.

Tant que les 1 condition ci-dessus sont remplies, des essais supplémentaires sur l'émetteur ne seront pas nécessaires. Toutefois, l'intégrateur OEM est toujours responsable des essais sur son produit final pour toutes exigences de conformité supplémentaires requis pour ce module installé.

**IMPORTANT NOTE:**

In the event that these conditions cannot be met (for example certain laptop configurations or co-location with another transmitter), then the Canada authorization is no longer considered valid and the IC ID cannot be used on the final product. In these circumstances, the OEM integrator will be responsible for re-evaluating the end product (including the transmitter) and obtaining a separate Canada authorization.

**NOTE IMPORTANTE:**

Dans le cas où ces conditions ne peuvent être satisfaites (par exemple pour certaines configurations d'ordinateur portable ou de certaines co-localisation avec un autre émetteur), l'autorisation du Canada n'est plus considéré comme valide et l'ID IC ne peut pas être utilisé sur le produit final. Dans ces circonstances, l'intégrateur OEM sera chargé de réévaluer le produit final (y compris l'émetteur) et l'obtention d'une autorisation distincte au Canada.

**End Product Labeling**

The final end product must be labeled in a visible area with the following: "Contains IC: 3147A-BL651".

**Plaque signalétique du produit final**

Le produit final doit être étiqueté dans un endroit visible avec l'inscription suivante: "Contient des IC: 3147A-BL651".

**Manual Information to the End User**

The OEM integrator has to be aware not to provide information to the end user regarding how to install or remove this RF module in the user's manual of the end product which integrates this module.

The end user manual shall include all required regulatory information/warning as show in this manual.

**Manuel d'information à l'utilisateur final**

L'intégrateur OEM doit être conscient de ne pas fournir des informations à l'utilisateur final quant à la façon d'installer ou de supprimer ce module RF dans le manuel de l'utilisateur du produit final qui intègre ce module.

Le manuel de l'utilisateur final doit inclure toutes les informations réglementaires requises et avertissements comme indiqué dans ce manuel.

## 10 JAPAN (MIC) REGULATORY

The BL651 is approved for use in the Japanese market. The part numbers listed below hold WW type certification. Refer to **ARIB-STD-T66** for further guidance on OEM's responsibilities.

Model	Certificate Number	Antenna
453-00005	201-180356	PCB Trace
453-00006	201-180356	IPEX MHF4



## 10.1 Antenna Information

The BL651 was tested with antennas listed below. The OEM can choose a different manufacturer's antenna but must make sure it is of the same type and that the gain is less than or equal to the antenna that is approved for use.

Manufacturer	Model	Laird Part Number	Type	Connector	Peak Gain	
					2400-2480 MHz	2400-2500 MHz
Laird	NanoBlue	EBL2400A1-10MH4L	PCB Dipole	IPEX MHF4		2 dBi
Laird	FlexPIFA	001-0022	PCB Dipole	IPEX MHF4	2 dBi	
Mag.Layers	EDA-8709-2G4C1-B27-CY	0600-00057	Dipole	IPEX MHF4		2 dBi
Laird	mFlexPIFA	EFA2400A3S-10MH4L	PIFA	IPEX MHF4	2 dBi	
Laird	453-00005 PCB printed antenna	NA	Printed PCB	N/A		0 dBi

## 11 CE REGULATORY

The BL651 series have been tested for compliance with relevant standards for the EU market. The 453-00006 module was tested with a 2 dBi antenna. The OEM can operate the 453-00006 module with any other type of antenna but must ensure that the gain does not exceed 2 dBi to maintain the Laird approval.

The OEM should consult with a qualified test house before entering their device into an EU member country to make sure all regulatory requirements have been met for their complete device.

Reference the Declaration of Conformities listed below for a full list of the standards that the modules were tested to. Test reports are available upon request.

### 11.1 Antenna Information

The antennas listed below were tested for use with the BL651. For CE mark countries, the OEM is free to use any manufacturer's antenna and type of antenna if the gain is less than or equal to the highest gain approved for use (2 dBi). Contact a Laird representative for more information regarding adding antennas.

Manufacturer	Model	Laird Part Number	Type	Connector	Peak Gain	
					2400-2480 MHz	2400-2500 MHz
Laird	NanoBlue	EBL2400A1-10MH4L	PCB Dipole	IPEX MHF4		2 dBi
Laird	FlexPIFA	001-0022	PCB Dipole	IPEX MHF4	2 dBi	
Mag.Layers	EDA-8709-2G4C1-B27-CY	0600-00057	Dipole	IPEX MHF4		2 dBi
Laird	mFlexPIFA	EFA2400A3S-10MH4L	PIFA	IPEX MHF4	2 dBi	
Laird	453-00005 PCB printed antenna	NA	Printed PCB	N/A		0 dBi

**Note:** The BL651 module internal BLE chipset IC pins are rated 4 kV (ESD HBM). ESD can find its way through the external JTAG connector (if used on the customer's design), if discharge is applied directly. Customer should ensure adequate protection against ESD on their end product design (using the BL651 module) to meet relevant ESD standard (for CE, this is EN301-489).

### 11.2 EU Declarations of Conformity

Manufacturer: Laird

<b>Products</b>	453-00005, 453-00006
<b>Product Description</b>	Bluetooth v5.0 Module Series
<b>EU Directives</b>	2014/53/EU – Radio Equipment Directive (RED)

**Reference standards used for presumption of conformity:**

Article Number	Requirement	Reference standard(s)
3.1a	Low voltage equipment safety	EN 60950-1:2006 +A11:2009 +A1:2010 +A12:2011 +A2:2013
	RF Exposure	EN 62311:2008
3.1b	Protection requirements – Electromagnetic compatibility	EN 301 489-1 v2.2.0 (2017-03) EN 301 489-17 v3.2.0 (2017-03)
3.2	Means of the efficient use of the radio frequency spectrum (ERM)	EN 300 328 v2.1.1 (2016-11) Wide-band transmission systems

**Declaration:**

We, Laird, declare under our sole responsibility that the essential radio test suites have been carried out and that the above product to which this declaration relates is in conformity with all the applicable essential requirements of Article 3 of the EU Radio Equipment Directive 2014/53/EU, when used for its intended purpose.

Place of Issue:	Laird W66N220 Commerce Court, Cedarburg, WI 53012 USA tel: +1-262-375-4400 fax: +1-262-364-2649
Date of Issue:	July 2018
Name of Authorized Person:	Thomas T Smith, Director of EMC Compliance

Signature of Authorized Person:

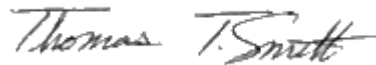

## 12 ORDERING INFORMATION

<b>453-00005</b>	BL651 Series - Bluetooth v5 Module, Int. Antenna (Nordic nRF52810) – Tape & Reel
<b>453-00006</b>	BL651 Series - Bluetooth v5 Module, Ext. Antenna (Nordic nRF52810) – Tape & Reel
<b>453-00005C</b>	BL651 Series - Bluetooth v5 Module, Int. Antenna (Nordic nRF52810)– Cut Tape
<b>453-00006C</b>	BL651 Series - Bluetooth v5 Module, Ext. Antenna (Nordic nRF52810)– Cut Tape

## 13 BLUETOOTH SIG QUALIFICATION

### 13.1 Overview

The BL651 series is listed on the Bluetooth SIG website as a qualified Tested Component.

Design Name	Owner	Declaration ID	QD ID	Link to listing on the SIG website
BL651 Series	Laird Technologies	D041399	117616	<a href="https://launchstudio.bluetooth.com/ListingDetails/67596">https://launchstudio.bluetooth.com/ListingDetails/67596</a>

It is a mandatory requirement of the Bluetooth Special Interest Group (SIG) that every product implementing Bluetooth technology has a Declaration ID. Every Bluetooth design is required to go through the qualification process, even when

referencing a Bluetooth Design that already has its own Declaration ID. The Qualification Process requires each company to be registered as a member of the Bluetooth SIG – [www.bluetooth.org](http://www.bluetooth.org)

The following link provides a link to the Bluetooth Registration page: <https://www.bluetooth.org/login/register/>

For each Bluetooth Design, it is necessary to purchase a Declaration ID. This can be done before starting the new qualification, either through invoicing or credit card payment. The fees for the Declaration ID will depend on your membership status, please refer to the following webpage:

<https://www.bluetooth.org/en-us/test-qualification/qualification-overview/fees>

For a detailed procedure of how to obtain a new Declaration ID for your design, please refer to the following SIG document:

[https://www.bluetooth.org/DocMan/handlers/DownloadDoc.ashx?doc\\_id=283698&vId=317486](https://www.bluetooth.org/DocMan/handlers/DownloadDoc.ashx?doc_id=283698&vId=317486)

## 13.2 Qualification Steps When Referencing a Laird Component Design

To start a listing in Launch Studio, follow these steps:

1. Go to: [https://www.bluetooth.org/tpg/QLI\\_SDoc.cfm](https://www.bluetooth.org/tpg/QLI_SDoc.cfm)
2. Select **Start the Bluetooth Qualification Process with Required Testing**.
3. Enter a project name for your design.
4. Enter the QDID for the Laird BL651 RF-PHY hardware, (117616). The Laird component should be automatically displayed in a drop-down menu.
5. Select the Laird component to add it to the design.

**Note:** To complete the End Product Design, you must also add additional components from Nordic Semiconductor, covering Link Layer and the upper Host Layers. To do this, repeat the same process as above, adding the specific Nordic component QDIDs. The minimum Core Layers for an LE design are RF-PHY, LL, SM, GATT, ATT, GAP, and L2CAP.

Examples of Nordic components are given below:

Listing reference (QDID)	Design Name	Core Spec Version
106843	S140 nRF52 Link Layer	5.0
111593	S140 nRF52 Host Layer	5.0

Once all components are combined in the design, select the TCRL version for the project, note that to avoid ICS inconsistencies it is better to select the older TCRL version if the option is provided. Select Product Type, 'End Product', Controller Core Configuration, [2/4] LE Controller and Host Core Configuration, [3/3] LE Host.

As the qualification status of all layers covered by the combined components can be inherited there is no need to re-test these layers, (components have a 3 year validation period where their qualification status can be inherited). If you want to add additional protocol layers and/or profiles, then add them to the design and set the ICS in each new layer. All new protocols and profiles added will need to be tested and evidence provided for the compliance folder.

Follow the steps in Launch Studio as follows:

1. Project Basics (Add Design Name, combine qualified components)
2. Layer Selection (add extra protocols and profiles if required)
3. ICS Selection (set features within extra protocols and profiles if required, run consistency check for errors)
4. Testing (Download Test Plan, Export ICS for PTS testing)
5. Test Documentation (Upload Test Plan and any Test Reports)

6. Product Declaration (Add design details and End Products that use the Bluetooth Design)
7. Purchase Declaration ID or select purchased ID for the design, (Try to purchase the Declaration ID before starting the listing process)
8. Review and Submit (Check all details, complete checklist and electronically signoff)

Once your Bluetooth Design is listed you should maintain a Compliance Folder for the life of the product. Any new products that incorporate the qualified design may be added to the listing free of charge, (this assumes no changes have been made to the original design). If Nordic release new reference components and you wish to combine these into your design, it will be necessary to purchase a new Declaration ID and complete a qualification.

For further information, please refer to the following training material:

<https://www.bluetooth.org/en-us/test-qualification/qualification-overview/listing-process-updates>

## 14 ADDITIONAL ASSISTANCE

Please contact your local sales representative or our support team for further assistance:

Email: [wireless.support@lairdtech.com](mailto:wireless.support@lairdtech.com)

Phone: Americas: +1-800-492-2320

Europe: +44-1628-858-940

Hong Kong: +852 2923 0610

Web: <https://connectivity.lairdtech.com/wireless-modules/bluetooth-modules>

© Copyright 2019 Laird. All Rights Reserved. Patent pending. Any information furnished by Laird and its agents is believed to be accurate and reliable. All specifications are subject to change without notice. Responsibility for the use and application of Laird materials or products rests with the end user since Laird and its agents cannot be aware of all potential uses. Laird makes no warranties as to non-infringement nor as to the fitness, merchantability, or sustainability of any Laird materials or products for any specific or general uses. Laird, Laird Technologies, Inc., or any of its affiliates or agents shall not be liable for incidental or consequential damages of any kind. All Laird products are sold pursuant to the Laird Terms and Conditions of Sale in effect from time to time, a copy of which will be furnished upon request. When used as a tradename herein, Laird means Laird PLC or one or more subsidiaries of Laird PLC. Laird™, Laird Technologies™, corresponding logos, and other marks are trademarks or registered trademarks of Laird. Other marks may be the property of third parties. Nothing herein provides a license under any Laird or any third party intellectual property right.