

---

---

**2.4 GHz / 5.5 GHz Waterproof Dipole 2 dBi Antenna, IP67**

---

---



**ORDERING INFORMATION**

Order Number	Description
<b>001-0012</b>	2.4/5.5 GHz Waterproof Dipole Antenna for Reverse Polarity SMA Connector, IP67
<b>080-0013</b>	U.FL to Reverse Polarity SMA Cable, 105mm, O-Ring Seal
<b>080-0014</b>	U.FL to Reverse Polarity SMA Cable, 210mm, O-Ring Seal

**Table 1 Orderable Part Numbers**

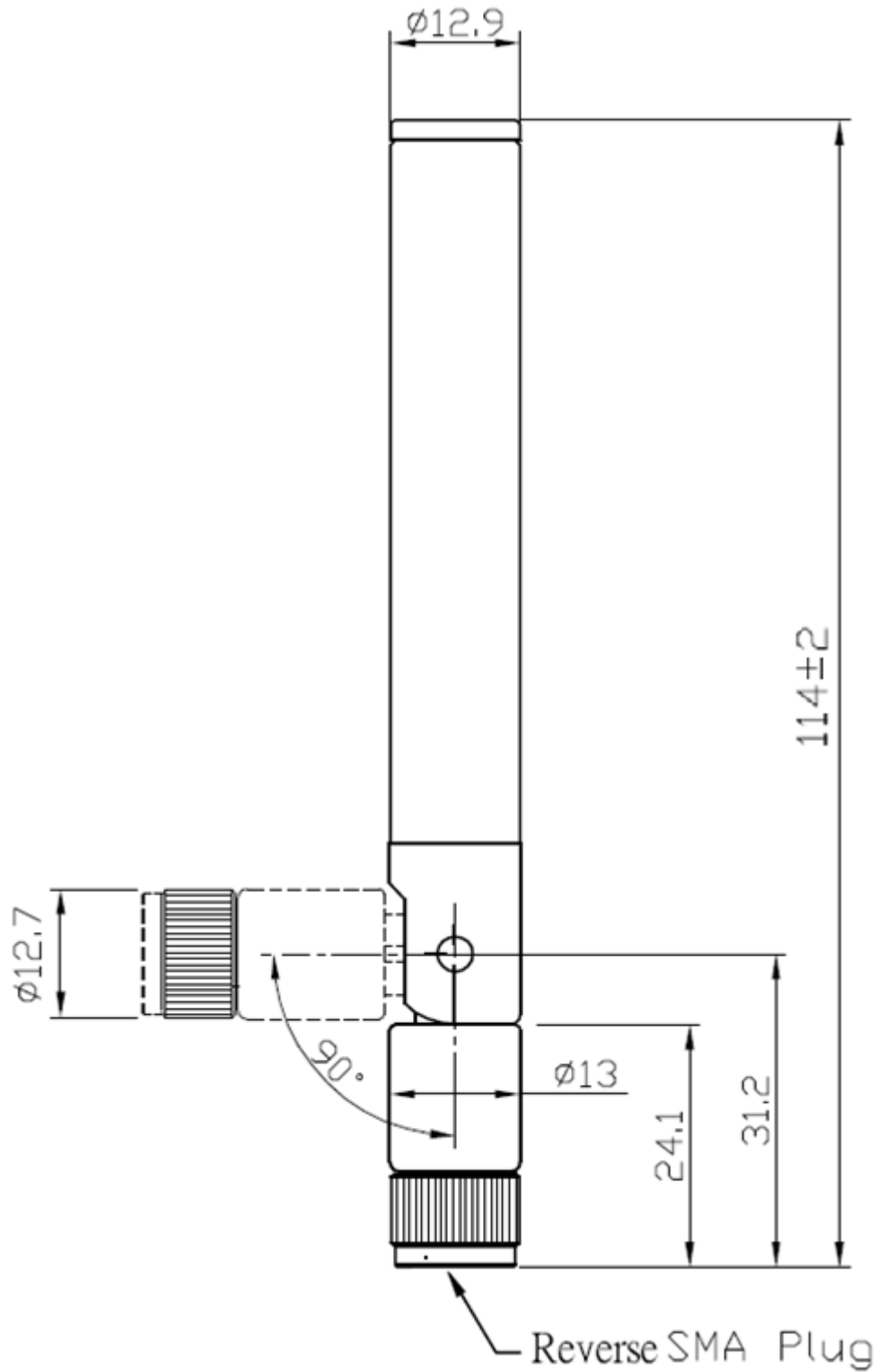
### SPECIFICATIONS

Specification	Value
2.4 Ghz Band Gain	+2 dBi
5 GHz Band Gain	+2 dBi
Impedance	50 ohms
Type	Dipole
Polarization	Linear Vertical
VSWR	≤2.5 : 1
Frequency	2400 - 2500MHz, 4910 - 5850MHz
Weight	18g
Size	114 mm × 13 mm
Antenna Color	Black
Operating Temp	-40°C to +85°C
UL Rating	UL 94HB

**Table 2 Specifications**

The information in this document is subject to change without notice.

**PHYSICAL DIMENSIONS (MM)**

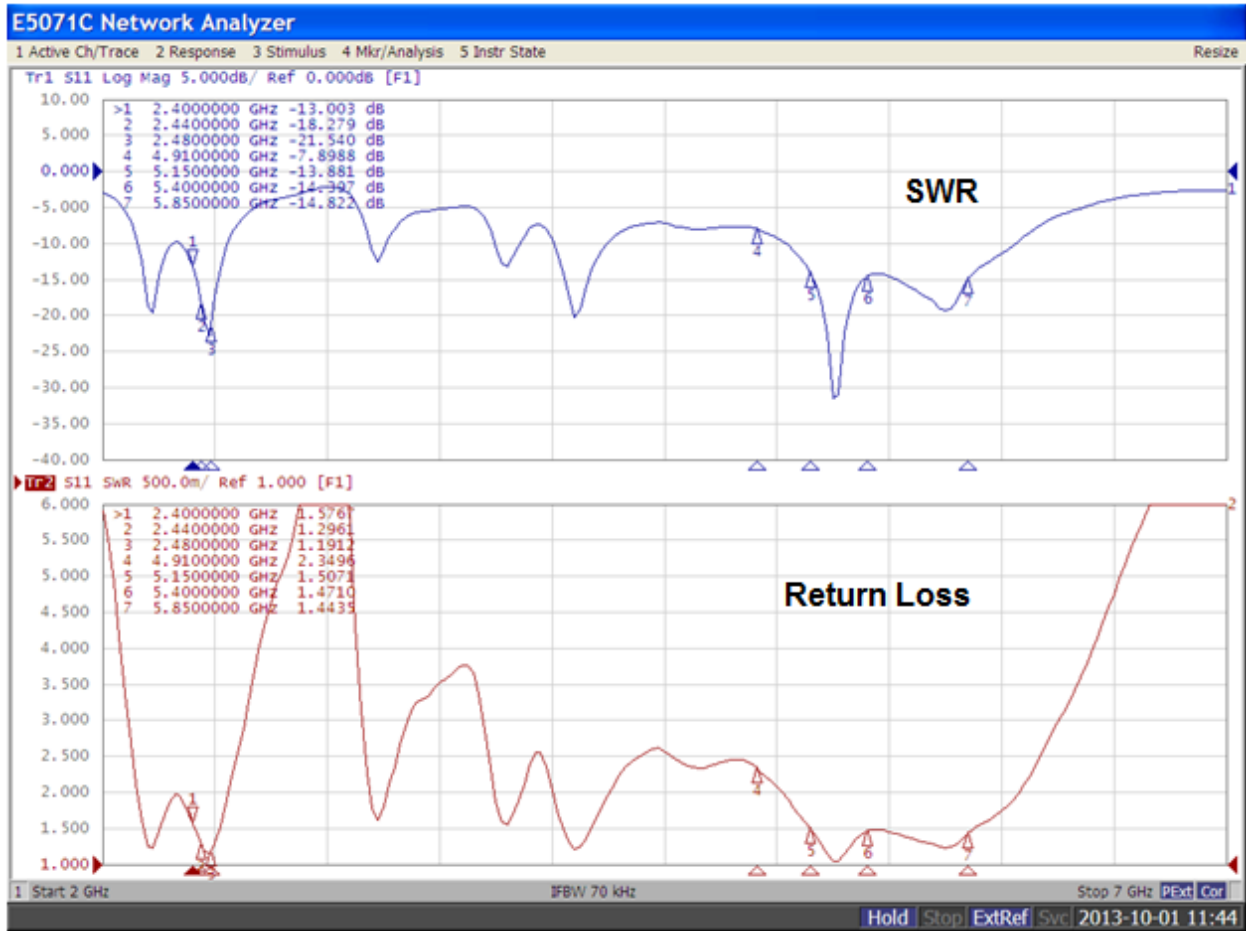


**Figure 1 Physical Dimensions**

The information in this document is subject to change without notice.

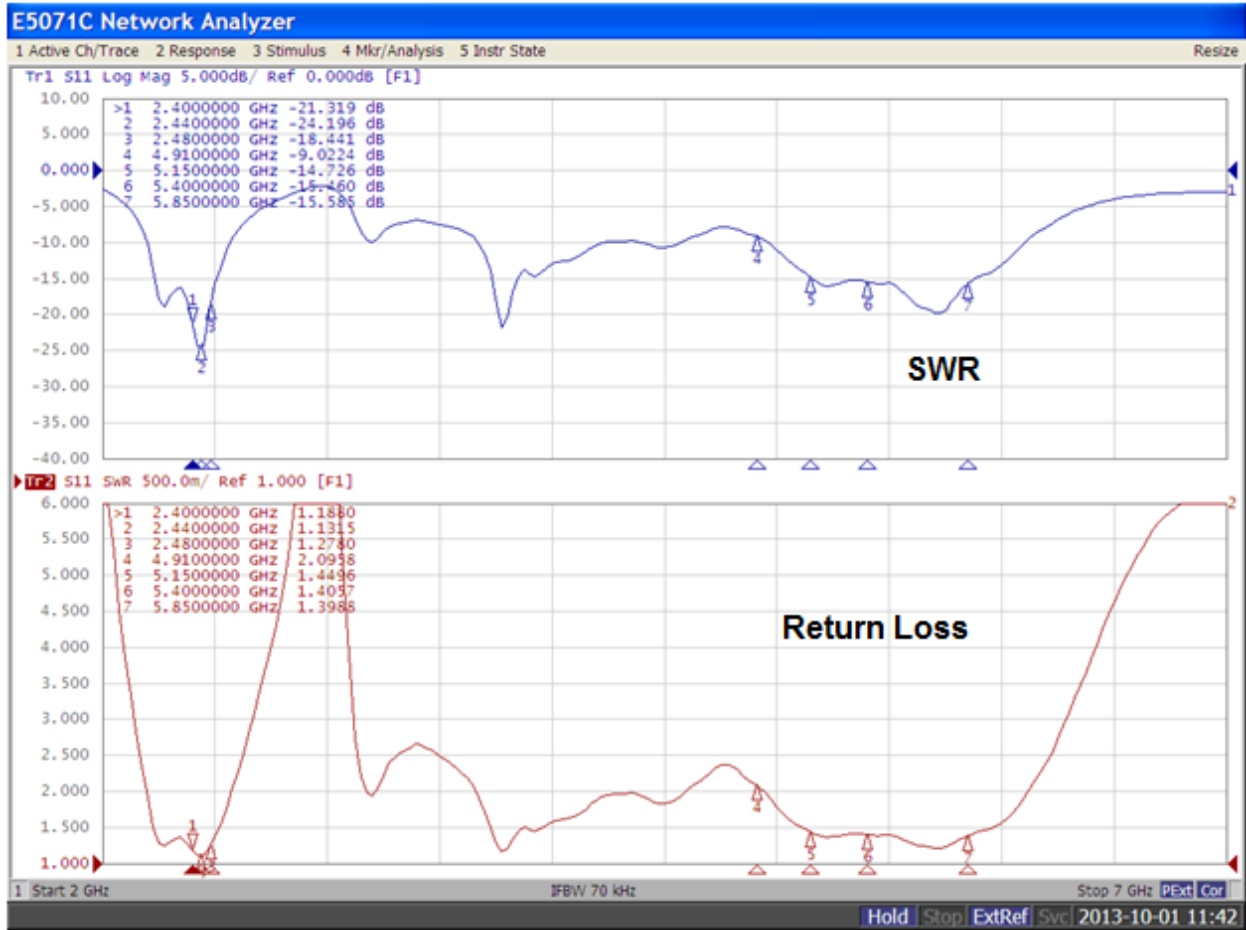
**TYPICAL ANTENNA REFLECTION PERFORMANCE**

**Straight Antenna Position**



**Figure 2 Typical Straight Position Reflection Performance**

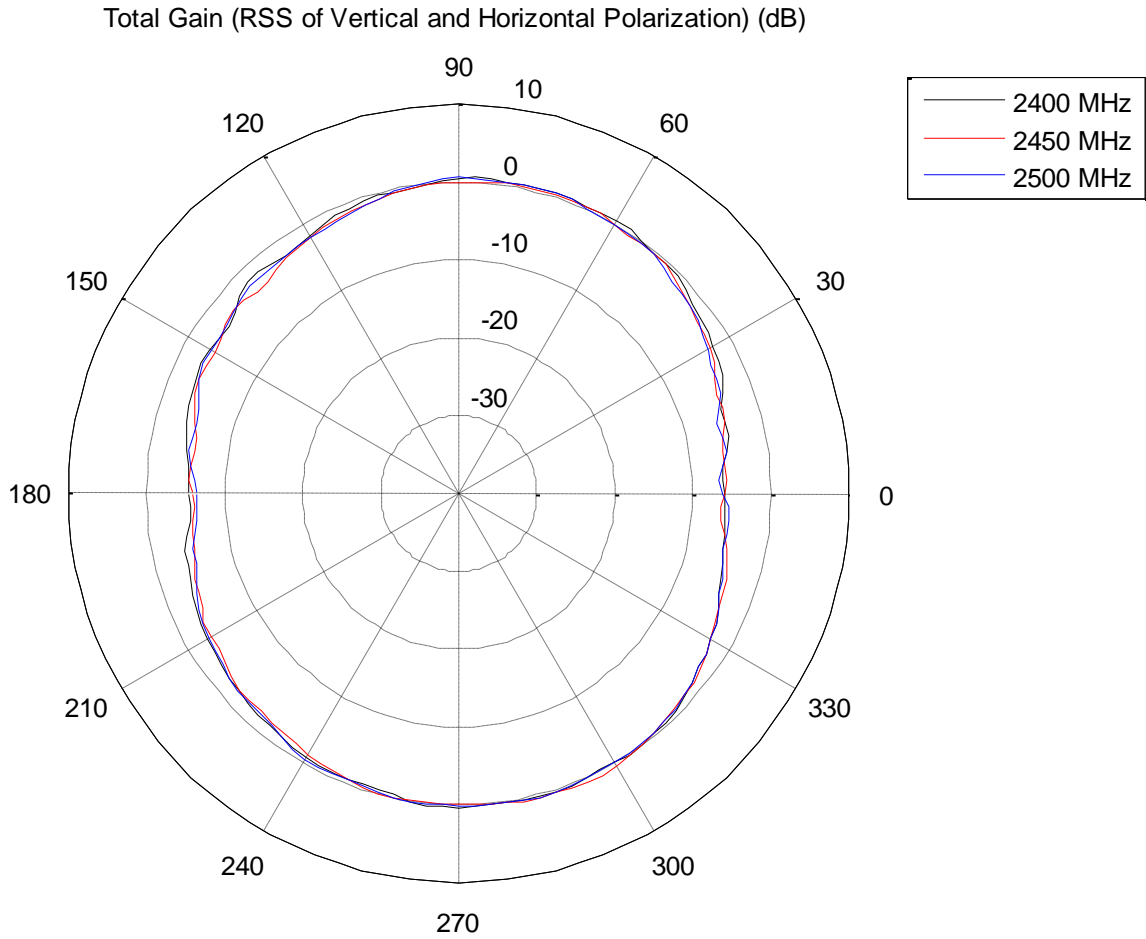
**Bent Antenna Position**



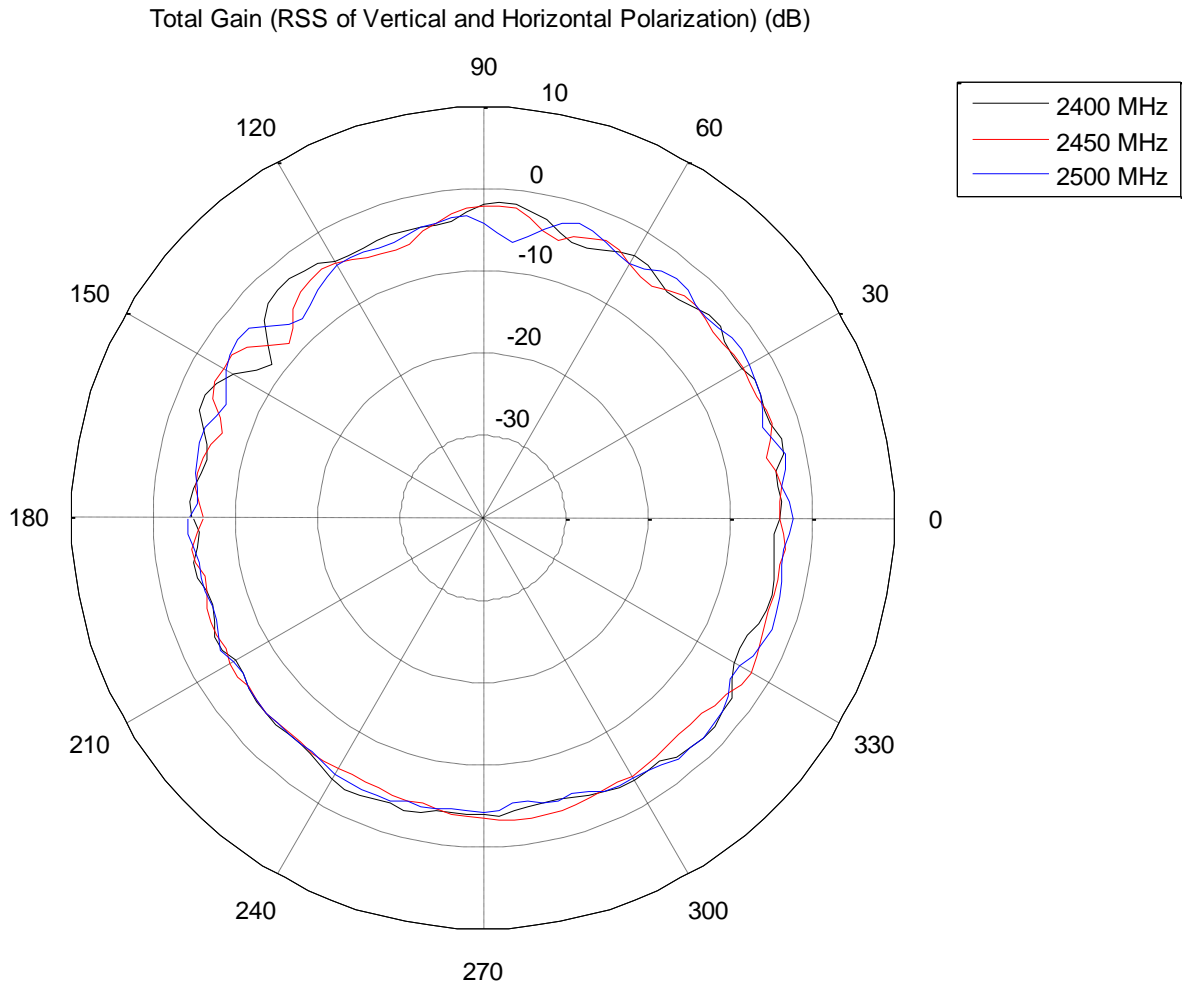
**Figure 3 Typical Bent Position Reflection Performance**

**TYPICAL ANTENNA RADIATION PERFORMANCE**

**2.4 GHz Band**

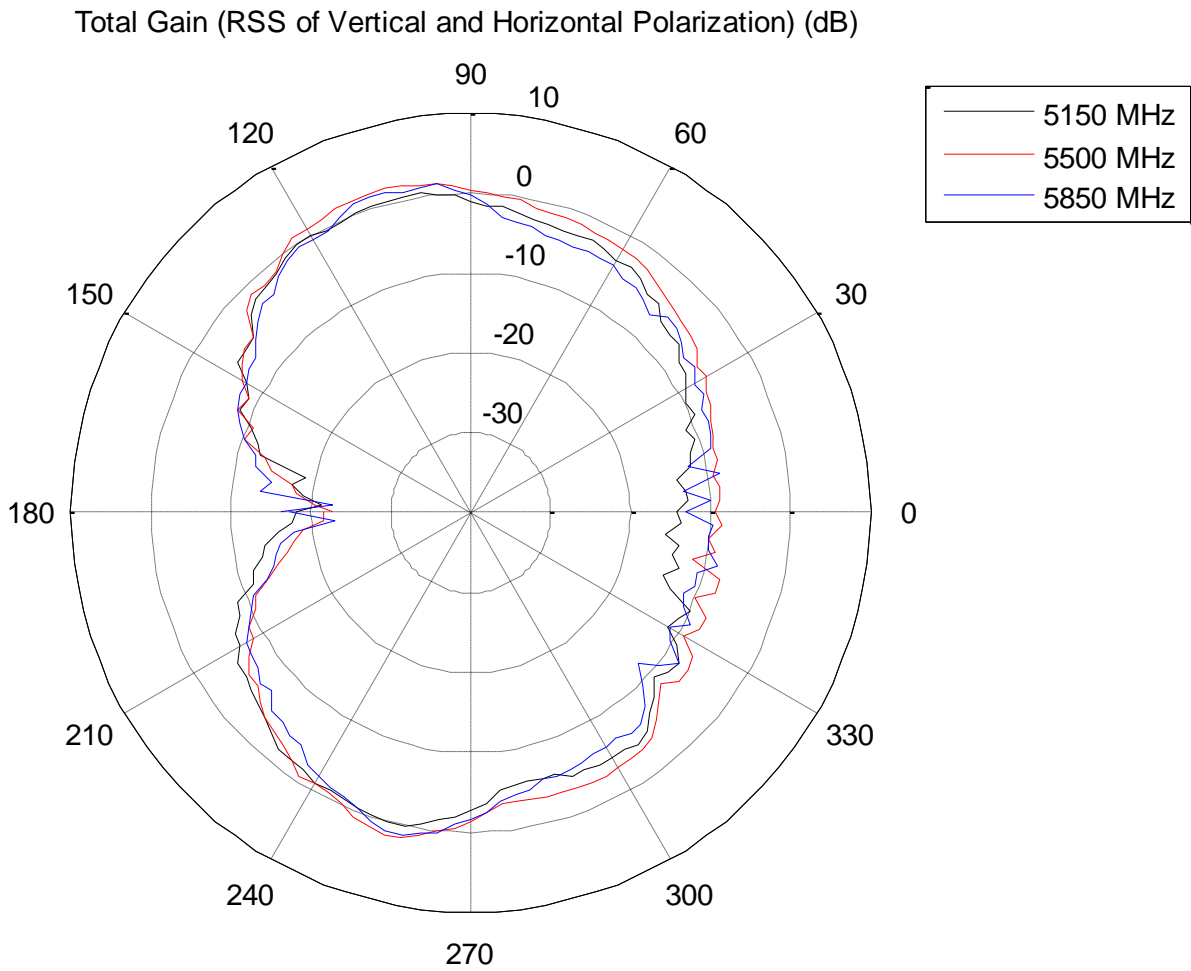


**Figure 4 Typical E-Plane Performance**



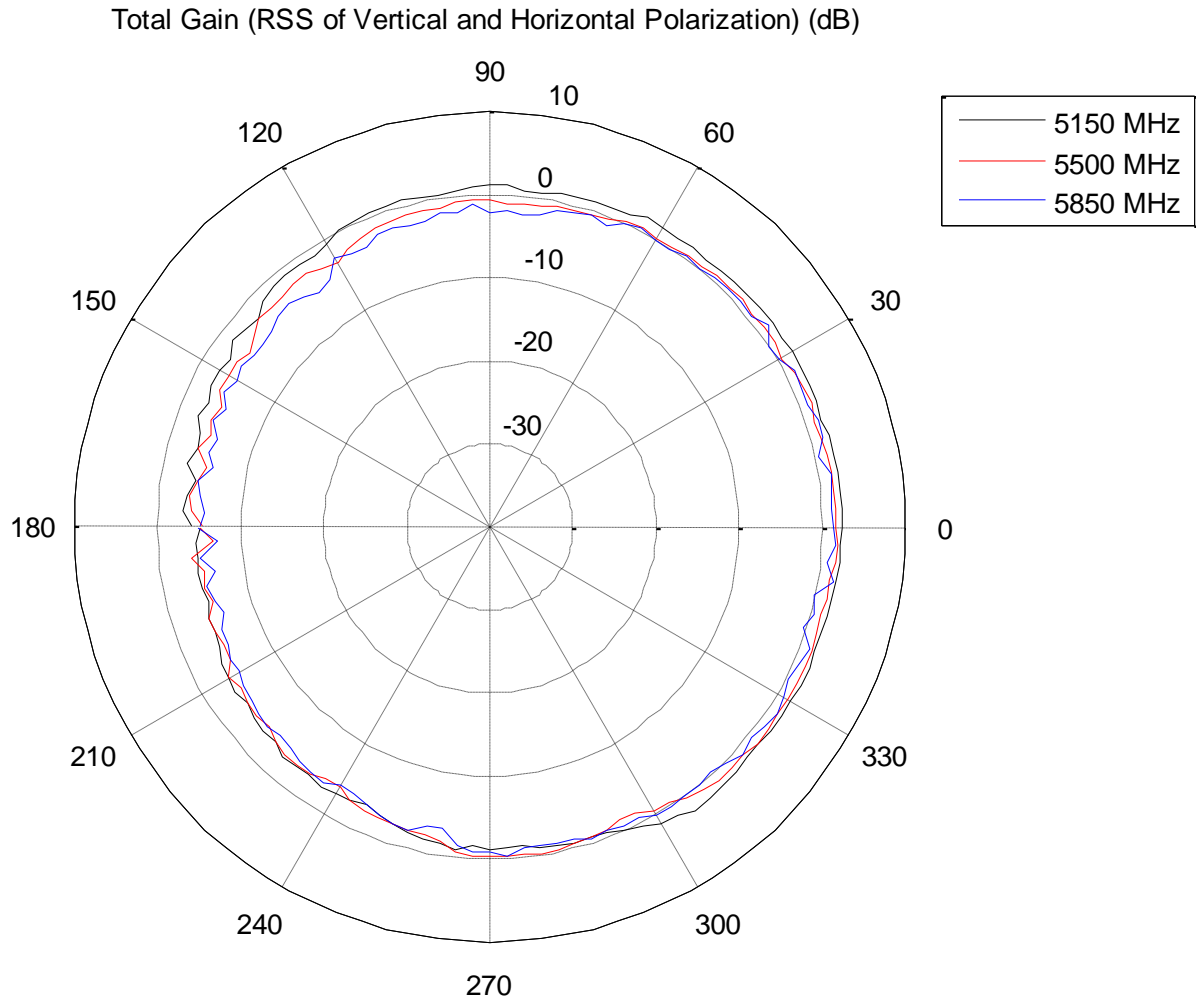
**Figure 5 Typical H-Plane Performance**

### 5 GHz Band



**Figure 6 Typical E-Plane Performance**





**Figure 7 Typical H-Plane Performance**

### CONTACTING LS RESEARCH

<b>Headquarters</b>	LS Research, LLC W66 N220 Commerce Court Cedarburg, WI 53012-2636 USA Tel: 1(262) 375-4400 Fax: 1(262) 375-4248
<b>Website</b>	<a href="http://www.lsr.com">www.lsr.com</a>
<b>Wiki</b>	<a href="http://www.lsr.com/products-wiki">www.lsr.com/products-wiki</a>
<b>Technical Support</b>	<a href="http://www.lsr.com/products-forum">www.lsr.com/products-forum</a>
<b>Sales Contact</b>	<a href="mailto:sales@lsr.com">sales@lsr.com</a>

© Copyright 2018 Laird. All Rights Reserved. Patent pending. Any information furnished by Laird and its agents is believed to be accurate and reliable. All specifications are subject to change without notice. Responsibility for the use and application of Laird materials or products rests with the end user since Laird and its agents cannot be aware of all potential uses. Laird makes no warranties as to non-infringement nor as to the fitness, merchantability, or sustainability of any Laird materials or products for any specific or general uses. Laird, Laird Technologies, Inc., or any of its affiliates or agents shall not be liable for incidental or consequential damages of any kind. All Laird products are sold pursuant to the Laird Terms and Conditions of Sale in effect from time to time, a copy of which will be furnished upon request. When used as a tradename herein, Laird means Laird Limited due to the acquisition by Advent or one or more subsidiaries of Laird Limited. Laird™, Laird Technologies™, corresponding logos, and other marks are trademarks or registered trademarks of Laird. Other marks may be the property of third parties. Nothing herein provides a license under any Laird or any third party intellectual property right.

---

The information in this document is subject to change without notice.