

30 kHz - 12.5 GHz OPTICAL RECEIVER

MODEL: DR-125G-A

FEATURES

- 10.7 and 12.5 Gb/s
- Hermetic Kovar package
- Available as “drop-in”
- Single voltage supply
- Customized packages and electrical specifications available

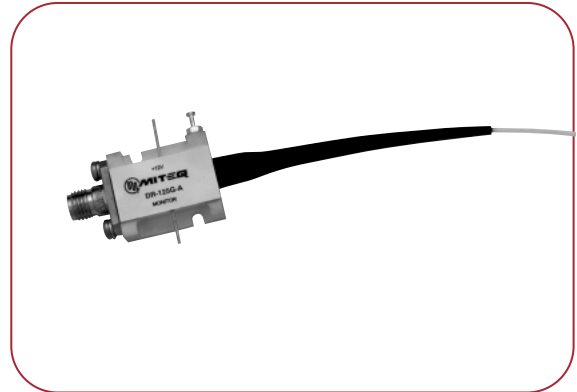

ELECTRICAL SPECIFICATIONS

PARAMETERS	CONDITION	UNITS	MIN.	TYP.	MAX.
Bandwidth	3 dB electrical		30 kHz		13 GHz
Photodiode responsivity		A/W	0.8	0.9	0.97
Transimpedance gain		Ohms	1780	2240	2820
Transimpedance gain (dB - Ω)		dB, ohms	65	67	69
Optical to electrical transfer gain (see Note 1)		V/W	1510	1900	2395
Dark current		nA		5	50
Sensitivity (see Note 2)	10.7 Gb/s 12.5 Gb/s	dBm dBm		-18 -17	
Group delay (see Note 3)		ps		100	200
RF output impedance		Ohms		50	
RF output VSWR			2:1		
Maximum output voltage		V, p-p	3.5	4.5	5
Logic sense	Inverting (non-inverting as option)				

NOTES:

1. Optical to electrical transfer gain measured as follows: Output V, p-p (in 50 ohm)/Input optical power (W, p-p).
2. NRZ, PRBS = $2^{31}-1$, B.E.R. = 10^{-10} .
3. Defined within the 3 dB optical to electrical bandwidth.

OPTICAL PERFORMANCE SPECIFICATIONS

PARAMETERS	CONDITION	UNITS	MIN.	TYP.	MAX.
Optic connector (all standards available)	FC/APC standard				
Fiber (core/cladding)	9/125 μ m single mode fiber (1 meter)				
Input wavelength		nm	1280		1580
Microwave input power*	Overload	dBm			+5
Optical return loss		dB	30		

* Maximum overload defined as the maximum optical input power while maintaining the Bit Error Rate (B.E.R.) of 10^{-10} or better.
Test conditions: NRZ, 12.5 Gb/s, PRBS = $2^{31}-1$, B.E.R. = 10^{-10} .

ORDERING INFORMATION

Receiver without monitor Part number: DR-125G-A
Receiver with monitor Part number: DR-125G-MV

TYPICAL TEST DATA

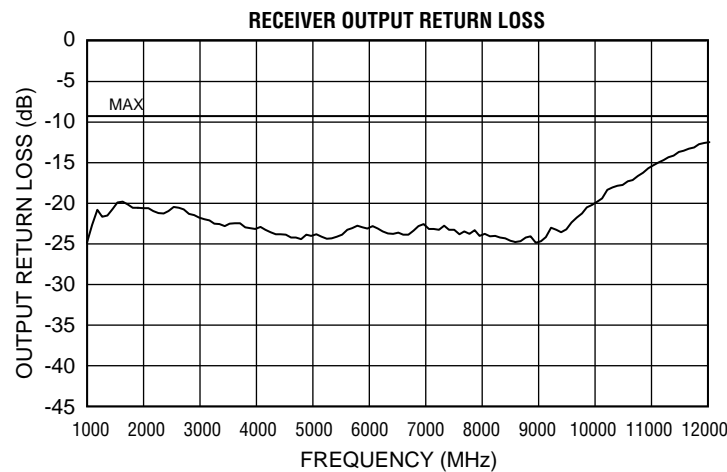
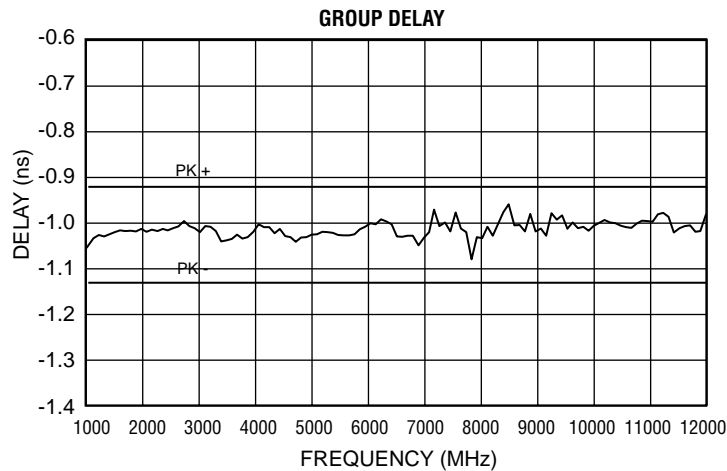
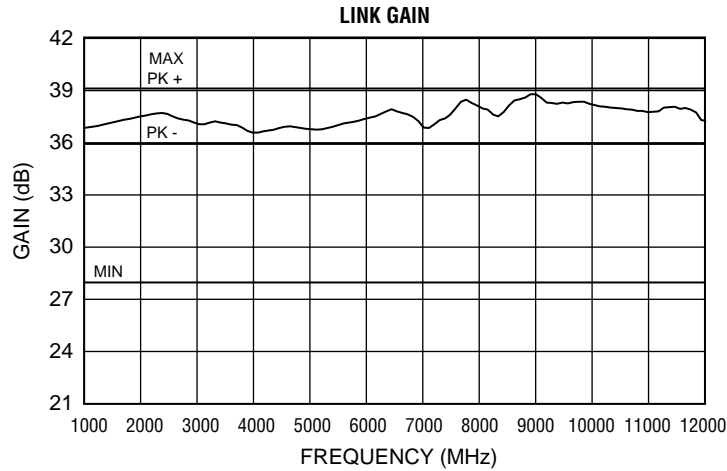

GENERAL CONDITIONS

Voltage range +11 V to +16 V
 Current..... 230 mA typical to 275 mA maximum
 RF connectors SMA female standard
 Optional operation+12 VDC

ENVIRONMENTAL CONDITIONS

Operating temperature..... -5 to +70°C
 Storage temperature -40 to +85°C
 Humidity 95% relative humidity, noncondensing

C40-1107-40



MEASUREMENTS

INPUT POWER -16 dBm

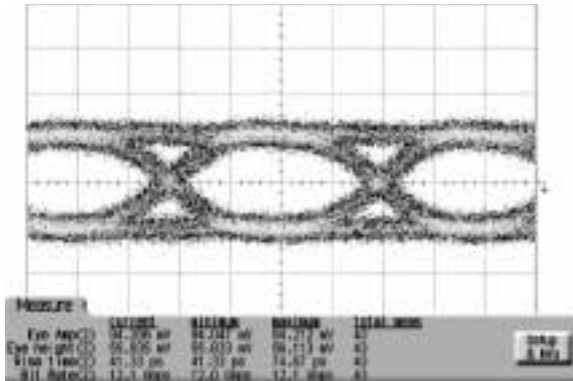

INPUT POWER -10 dBm

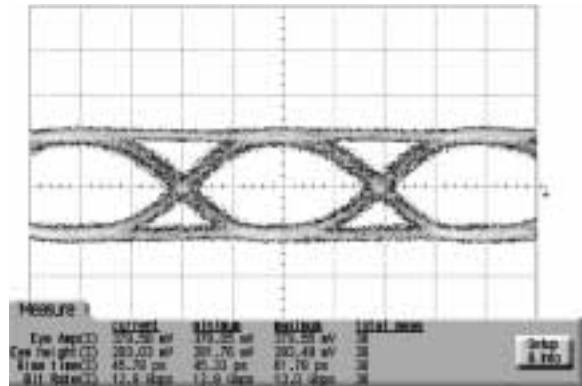

INPUT POWER -5 dBm

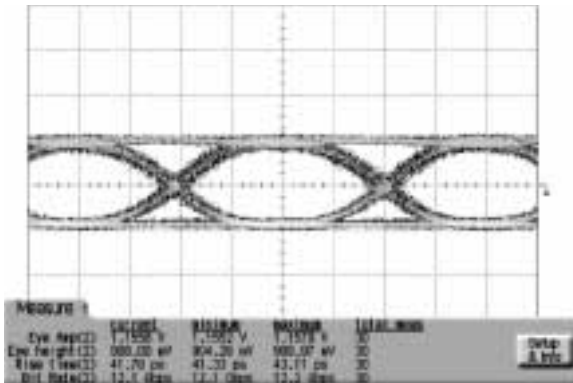

INPUT POWER 0 dBm

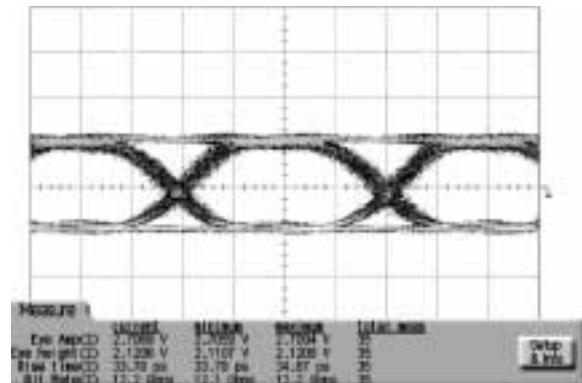

INPUT POWER +5 dBm

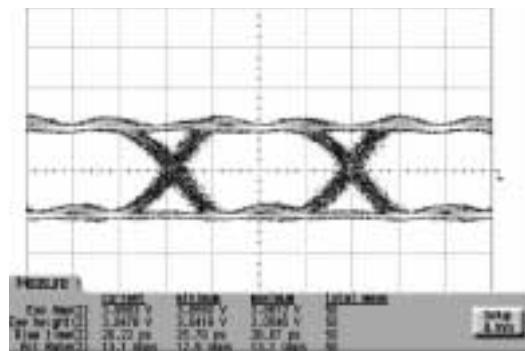

RECEIVER OUTLINE DRAWING

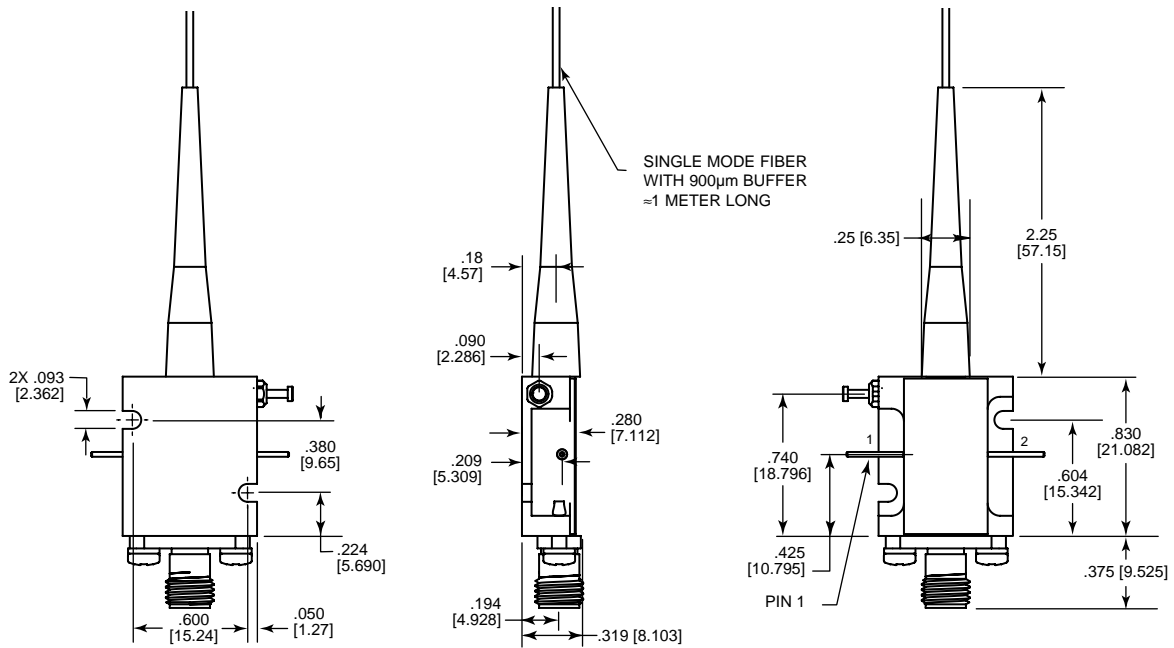

RECEIVER POWER SUPPLY

PIN	VOLTAGE	CURRENT (AMPS)	NOTES
1			REFER TO "OPERATIONAL STATUS"
2	+12	0.1	

RECEIVER OPERATIONAL STATUS

PIN	DESCRIPTION	NORMAL VOLTAGE	NOTES
1	OPTICAL CARRIER DETECT	> 1.0 UP TO +8	0 VOLTS INDICATES NO CARRIER PRESENT. VOLTAGE INCREASES APPROXIMATELY 1.3 V/mW WITH DETECTED OPTICAL POWER.

RF CONNECTOR: SMA (FEMALE STANDARD)
 OPTICAL CONNECTOR: FC/APC STANDARD (OTHER STANDARDS AVAILABLE)
 OPTICAL FIBER: 9/125 SINGLE MODE

NOTE: DIMENSIONS SHOWN IN BRACKETS [] ARE IN MILLIMETERS.