



Designers' Choice

PUSH-IN TERMINALS

For .062 & .093 Dia. Holes

Terminals are pressed into the holes of the board manually; or a low cost insertion tool can be supplied for use at the bench, or in an arbor or drill press.

- QUICK & EASY TO INSTALL • NO STAKING REQUIRED
- FOR PRODUCTION OR EXPERIMENTAL USE

"FLEA" CLIP

.062 Dia. Holes

For subminiature applications where conventional terminals are too large or too costly. The design engineer will find them most useful; and the serviceman will need these for quick repairs of printed circuitry. Simply insert wire thru hole and it is held firmly by spring wipe action assuring continued positive contact.

MATERIAL: .008 thick Beryllium Copper
FINISH: Bright Tin

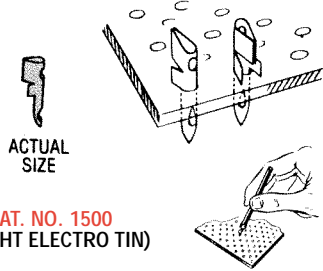
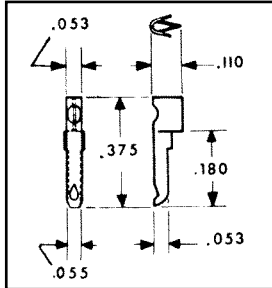

CAT. NO. 1500
(BRIGHT ELECTRO TIN)

Insertion Tool Cat. No. 1322

"IMP" TERMINAL

.062 Dia. Holes

The name implies the miniature characteristics of this terminal. It is only slightly larger than the "FLEA" clip. Excellent for point to point or feed thru wiring. Slot is serrated to grip component leads. Multiple connections are made quick and easy.

MATERIAL: .008 thick Beryllium Copper
FINISH: Tin Plate

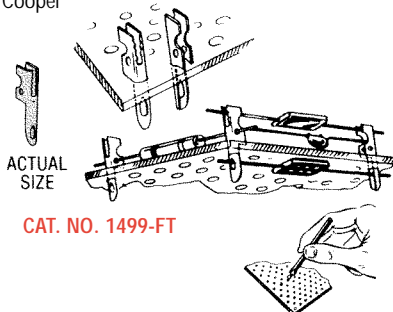
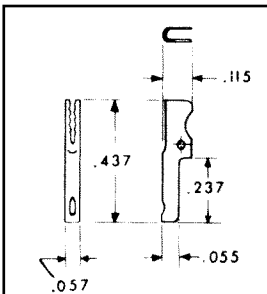

CAT. NO. 1499-FT

Insertion Tool Cat. No. 1322

SOLDERLESS TERMINAL

.093 Dia. Holes

Terminal for production or breadboarding use. Holds as many as 7 without soldering. A rugged, spring action precision stamped terminal.

MATERIAL: .015 Spring Steel
FINISH: Tin Plate

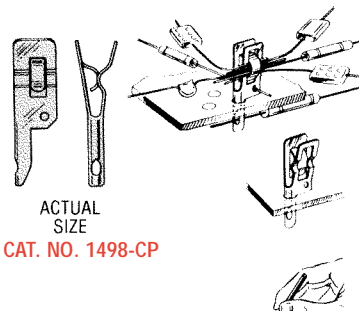
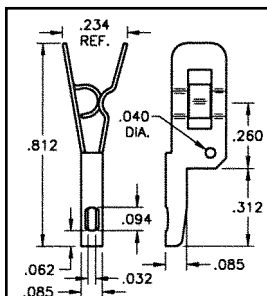

CAT. NO. 1498-CP

Insertion Tool Cat. No. 1323

MINIATURE TUBULAR TERMINALS

.062-.067 Dia. Holes

- IDEAL FOR PRINTED CIRCUITRY TAPERED SECTION RETAINS WIRE LEADS
- MOUNT TRANSISTORS, RESISTORS, NEONS
- POSITIVE LOCKING IN HOLE - NO STAKING REQUIRED

These terminals are often used for transistor and Bi-Pin lamp sockets. Terminals snap into a .062-.067 diam. Hole of a 1/16" thick insulator and are firmly held without the need of staking. Wire leads can be inserted from either end and retained. Terminals 1236 and 1237 have tapered socket spring forming that will hold a number of leads in position and allow multiple dip soldering. Terminals are pre-tinned for easy soldering.

MATERIAL: .006 Thick Brass
Precision Formed and Pre-Tinned
• HOLDS .010 TO .050 DIAMETER WIRE

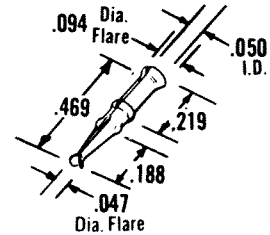
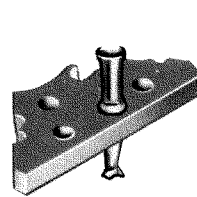

CAT. NO. 1236

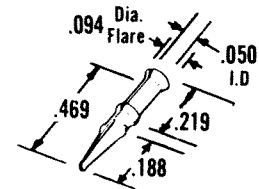
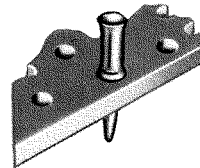

CAT. NO. 1237

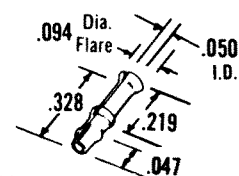
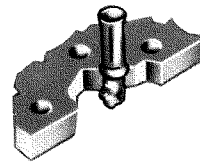

CAT. NO. 1238

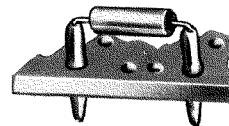

INSERTION TOOL FOR ABOVE
For Arbor Press or similar reciprocation device.
Specify CAT. NO. TL-11

For Hand Insertion Tool.
Specify CAT. NO. 1214

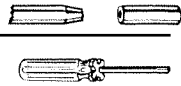

"MICRO" TERMINAL

Easily press-fit into a .042 dia. Hole without staking or the base may be flared for permanent installation. Ideally designed for use in circuitry to support components when space is at a premium.

MATERIAL: .008 Beryllium Copper, Tin Plate

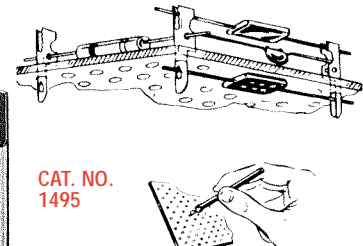
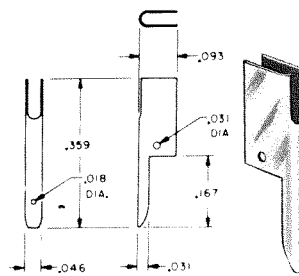

CAT. NO. 1495

Insertion Tool Cat. No. 1322