

Overview

The KEMET LF metal box filters cover single-phase or three-phase requirements with a wide variety of characteristics. These filters are optimized for both common and normal mode noise. Their input/output terminals are screw type or lead wire type.

Applications

- Industrial equipment
- Machine tool
- Inverters

Benefits

- Single-phase or three-phase
- Operating temperature range from -25°C to $+55^{\circ}\text{C}$ (with some exceptions at -20°C to 45°C and -20°C to $+55^{\circ}\text{C}$)
- UL approved versions available
- RoHS compliant



Part Number System

LF-	2	02	U		-1
Series	Phase	Rated Current (A)	Approval	Specification	Internal Management Code
LF	2 = Single-phase 3 = Three-phase	0x = 0x A xx = xx A	Blank = No approvals U = UL approved	Blank = Standard N = Double common choke P = Hi pot 2,000 V for single-phase	-F -1 -9

Dimensions – Millimeters

LF-202U-1

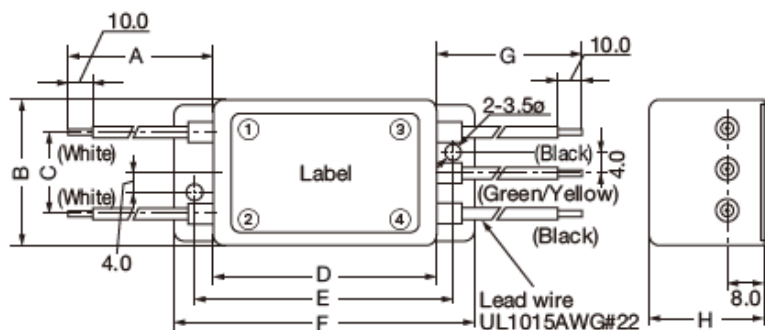

A	B	C	D	E	F	G	H
200	32	17	48	56	64	200	25

LF-202-9

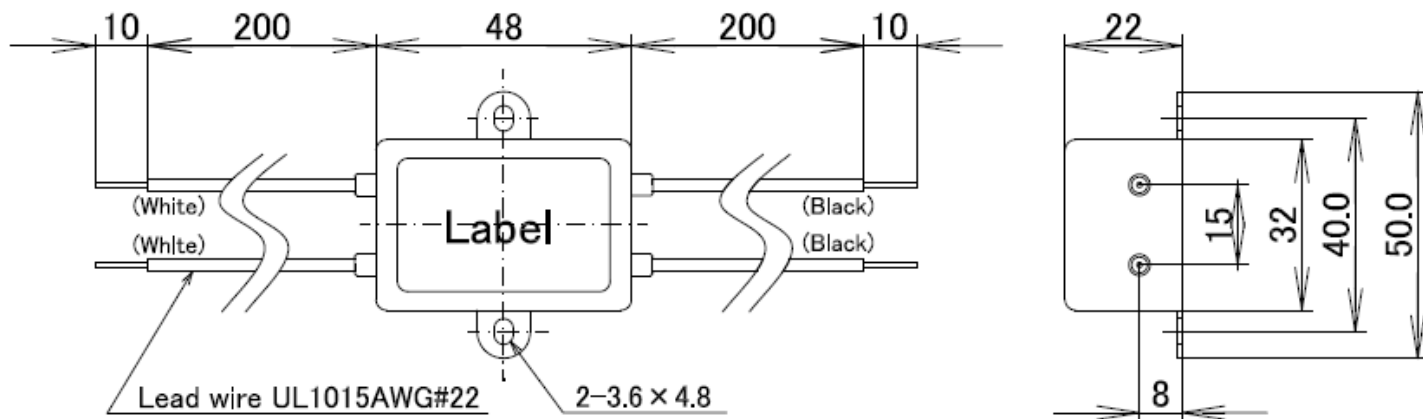

Dimensions - Millimeters cont.

LF-210, LF-210N, LF-215N

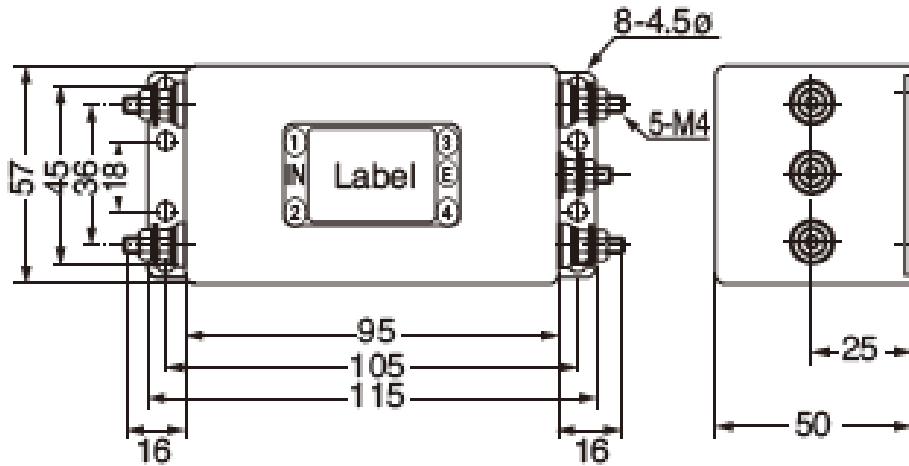

Recommended torque (N-m) maximum

- Line terminal (M4: 0.78)
- Earth terminal (M4: 1.18)

LF-215F, LF-215U

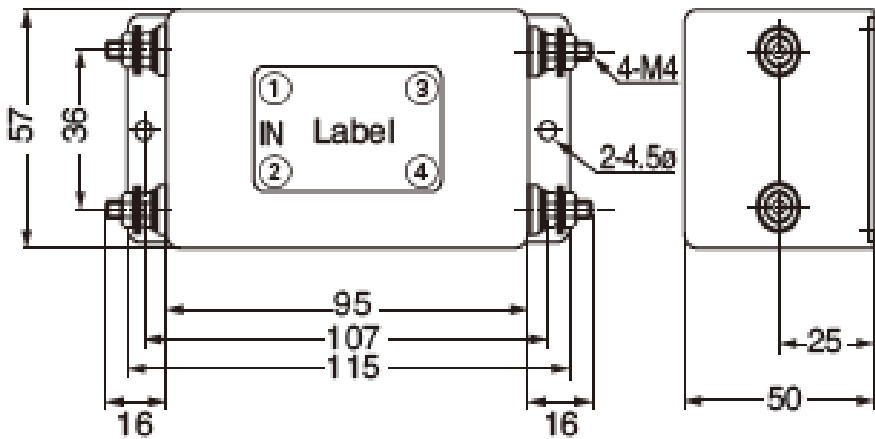

Recommended torque (N-m) maximum

- Line terminal (M4: 0.78)

Dimensions - Millimeters cont.

LF-220N, LF-230N

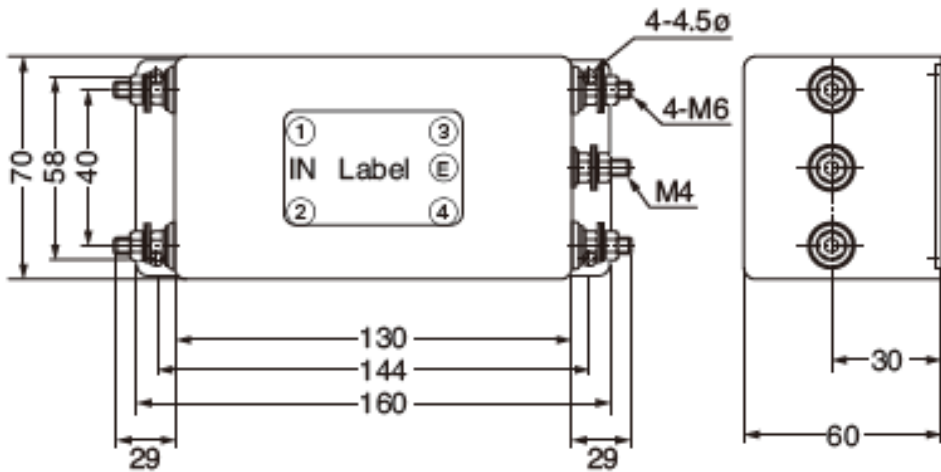

Recommended torque (N-m) maximum

- Line terminal (M6: 1.18)
- Earth terminal (M4: 1.18)

LF-240, LF-240P, LF-250, LF-250P

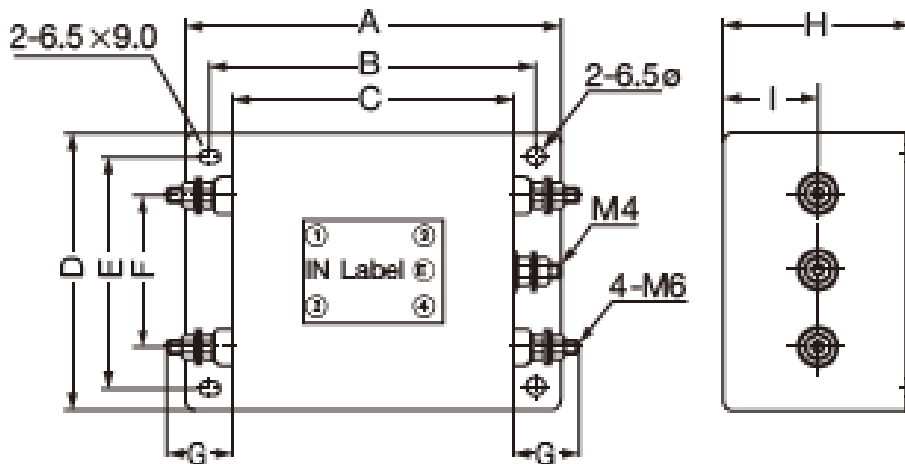

Recommended torque (N-m) maximum

- Line terminal (M6: 1.18)
- Earth terminal (M4: 1.18)

Part Number	A	B	C	D	E	F	G	H	I
LF-240	210	190	170	120	100	60	29	75	40
LF-240P									
LF-250	240	220	200	90	70	40	30	80	40
LF-250P									

Dimensions – Millimeters cont.

LF-260N

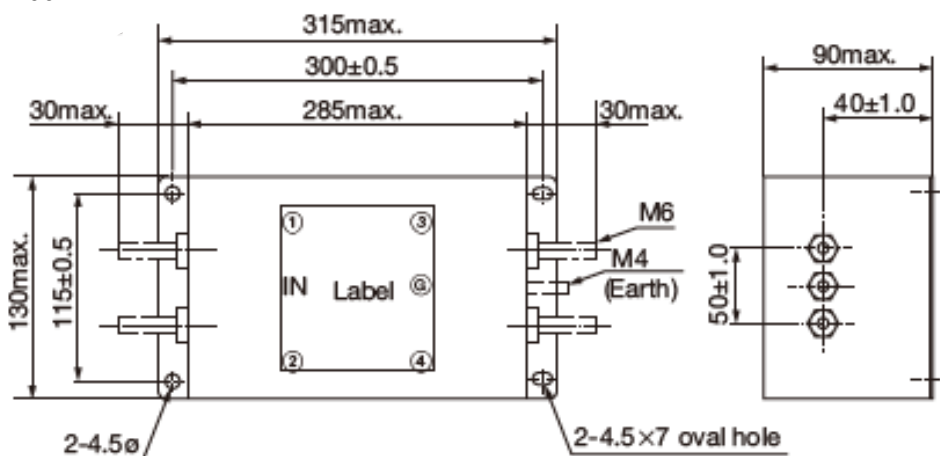

Recommended torque (N-m) maximum

- Line terminal (M6: 1.18)
- Earth terminal (M4: 1.18)

LF-305, LF-310, LF-315, LF-320, LF-330, LF-340

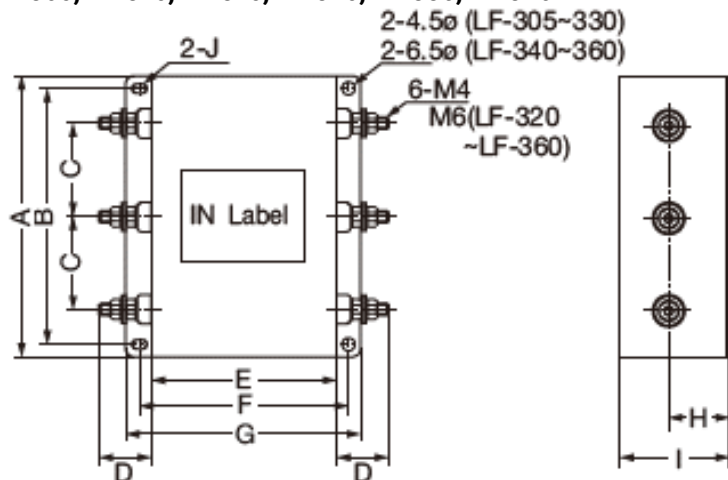

Recommended torque (N-m) maximum

- Line terminal (M6: 1.18)

Part Number	A	B	C	D	E	F	G	H	I	J		
LF-305	120	110	40	25	80	95	110	25	45	4.5x7		
LF-310	180	170	60		29	120	135	150	35		65	
LF-315				160		50	303	200	220		240	40
LF-320					6.5x9							
LF-330												
LF-340												

Environmental Compliance

All KEMET EMI-RFI Filters are RoHS compliant.



Performance Characteristics

Item	Performance Characteristics
Rated Voltage	250 V
Rated Current Range	2 – 60 A
Withstanding Voltage	1,500 VAC (1 minute, line to ground) except LF-xxxP: 2,000 VAC (1 minute, line to ground)
Insulation Resistance	300 MΩ minimum at 500 VDC (1 minute, line to ground)
Leakage Current Range	0.005 – 1.000 mA at 250 V/60 Hz maximum
Input/Output Terminal Type	Screw and Lead Wire
Operating Temperature Range	-25°C to +55°C (not including self temperature rise) (with some exceptions at -20°C to 45°C and -20°C to +55°C)

Table 1 – Ratings & Part Number Reference

Part Number	Phase	Rated Voltage AC/DC (V)	Rated Current AC/DC (A)	Leakage Current at 250 V/60 Hz (mA) Maximum	Temperature Rise (K) Maximum	Operating Temperature Range	Terminal Type	Approval	Weight (g)
LF-202U-1	Single-phase	250	2	1.000	30	-20°C to +55°C	Lead wire	UL	95
LF-202-9	Single-phase	250	2	0.005	30	-25°C to +55°C	Lead wire		50
LF-210	Single-phase	250	10	1.000	30	-20°C to +55°C	Screw	UL	590
LF-210N	Single-phase	250	10	1.000	30	-20°C to +55°C	Screw		650
LF-215N	Single-phase	250	15	1.000	30	-20°C to +55°C	Screw		650
LF-215F	Single-phase	250	15	1.000	30	-20°C to +55°C	Screw		650
LF-215U	Single-phase	250	15	1.000	30	-20°C to +55°C	Screw	UL	620
LF-220N	Single-phase	250	20	1.000	30	-20°C to +55°C	Screw		1,200
LF-230N	Single-phase	250	30	1.000	30	-20°C to +55°C	Screw		1,200
LF-240	Single-phase	250	40	1.000	40	-20°C to +45°C	Screw		3,200
LF-240P	Single-phase	250	40	1.000	40	-20°C to +45°C	Screw		3,200
LF-250	Single-phase	250	50	1.000	40	-20°C to +45°C	Screw		4,000
LF-250P	Single-phase	250	50	1.000	40	-20°C to +45°C	Screw		4,000
LF-260N	Single-phase	250	60	1.000	30	-20°C to +55°C	Screw		6,500

Table 1 – Ratings & Part Number Reference cont.

Part Number	Phase	Rated Voltage AC/DC (V)	Rated Current AC/DC (A)	Leakage Current at 250 V/60 Hz (mA) Maximum	Temperature Rise (K) Maximum	Operating Temperature Range	Terminal Type	Approval	Weight (g)
LF-305	Three-phase	250	5	1.000	30	-20°C to +55°C	Screw		650
LF-310	Three-phase	250	10	1.000	30	-20°C to +55°C	Screw	UL	1,900
LF-315	Three-phase	250	15	1.000	30	-20°C to +55°C	Screw		1,900
LF-320	Three-phase	250	20	1.000	30	-20°C to +55°C	Screw		2,300
LF-330	Three-phase	250	30	1.000	30	-20°C to +55°C	Screw		2,400
LF-340	Three-phase	250	40	1.000	40	-20°C to +45°C	Screw		5,300

Circuit Diagram

LF-202U-1

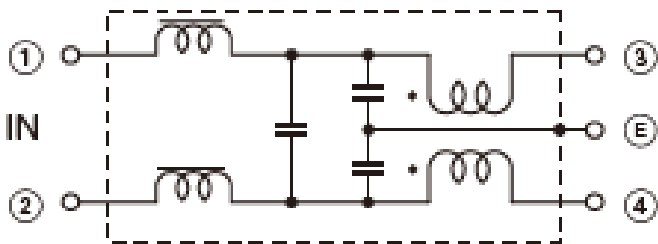

LF-202-9

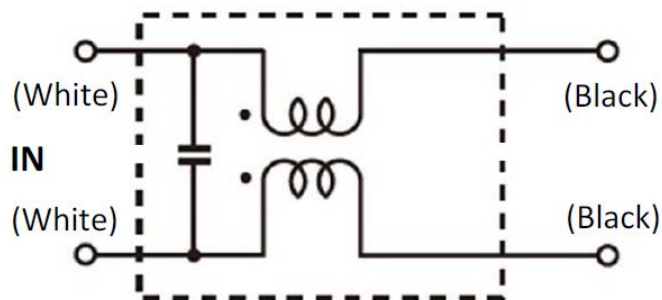

LF-210

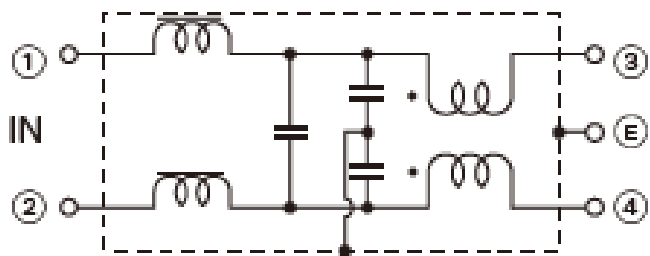

LF-210N, LF-215N

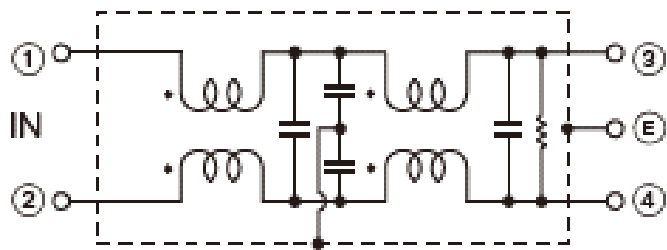

Circuit Diagram cont.

LF-215F, LF-215U

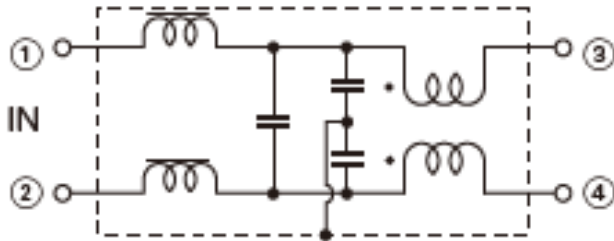

LF-220N, LF-230N

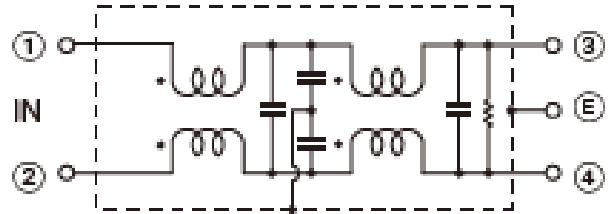

Measuring Circuit - Common Mode

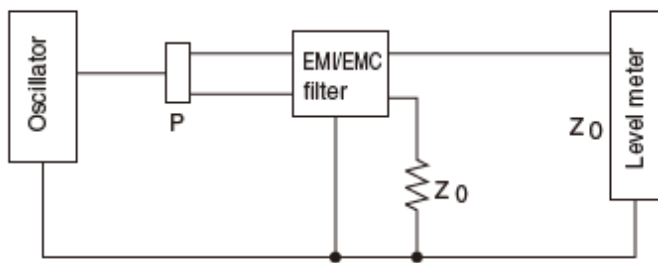

P: Power divider $Z_0 : 50\Omega$

Measuring Circuit - Normal Mode

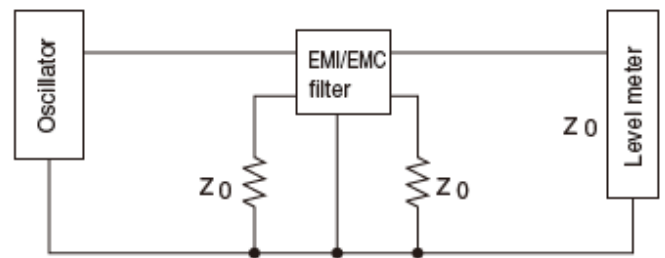

$Z_0 : 50\Omega$

Circuit Diagram cont.

LF-240, LF-240P, LF-250, LF-250P

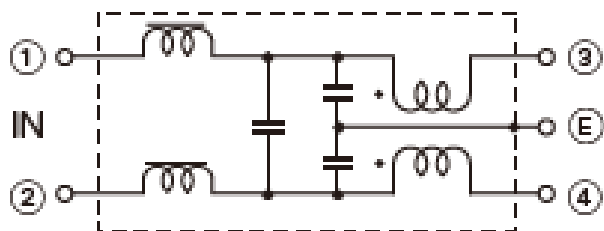

LF-260N

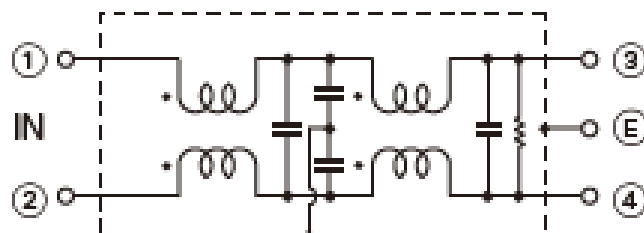

Measuring Circuit - Common Mode

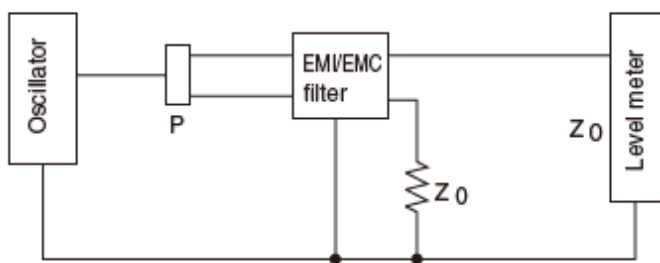

P: Power divider $Z_0: 50\Omega$

Circuit Diagram cont.

LF-305, LF-310, LF-315, LF-320, LF-330, LF-340

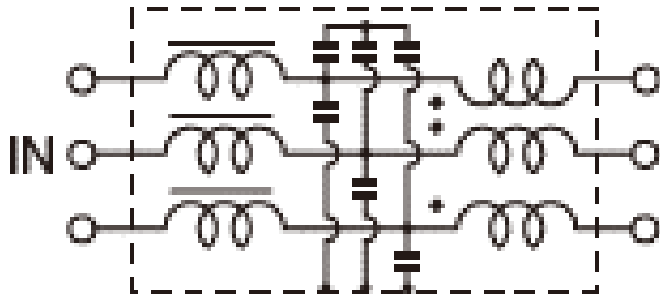

Measuring Circuit - Common Mode

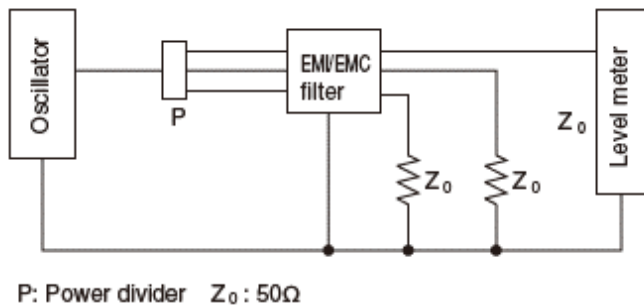

Measuring Circuit - Normal Mode

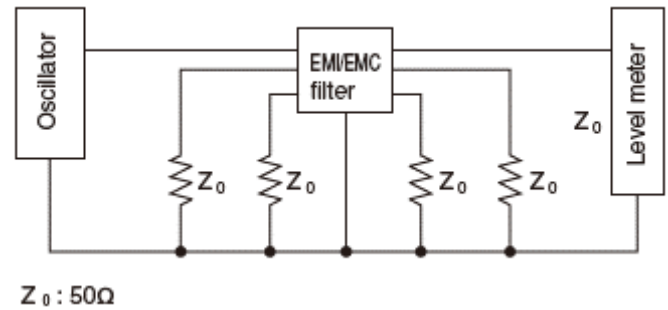

Attenuation (Static Characteristics)

LF-202U-1

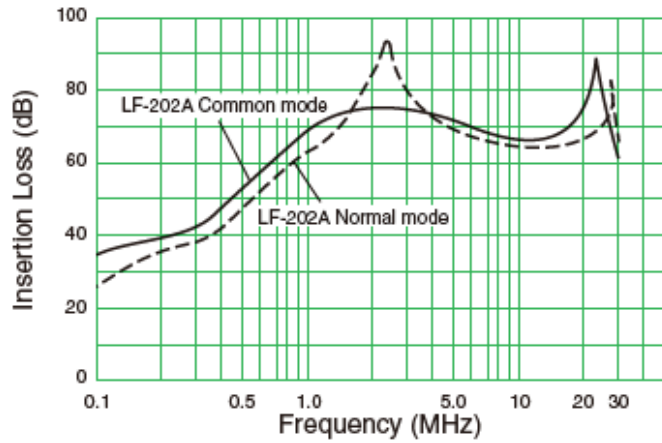

LF-202-9

Image coming soon

LF-210

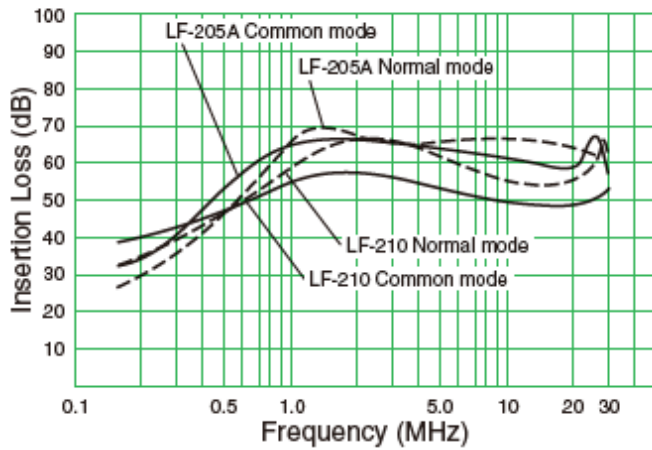

LF-215N, LN-215F, LF-215U

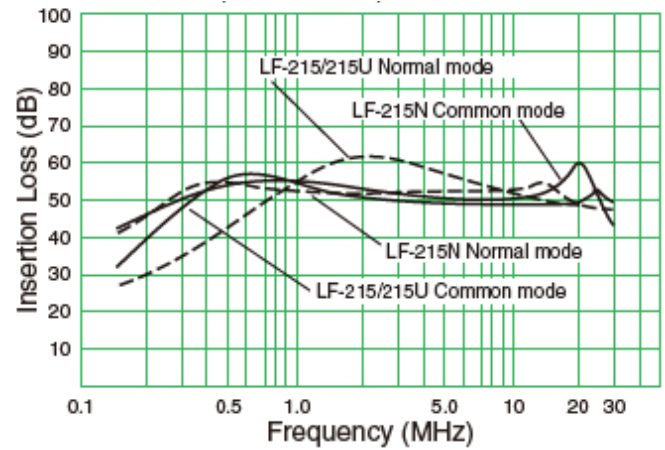

LF-240, LF-250

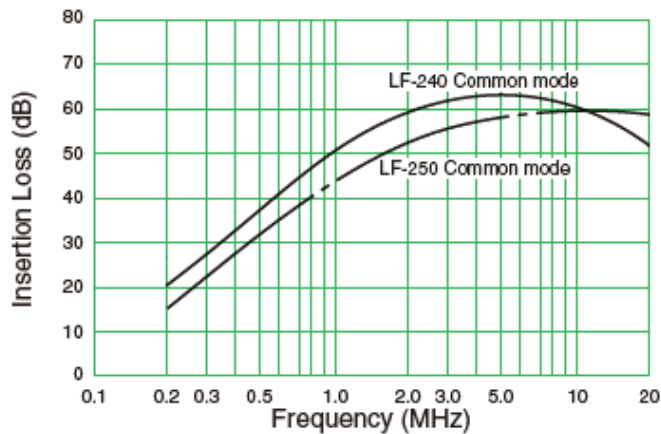

LF-240P, LF-250P

Image coming soon

Attenuation (Static Characteristics) cont.

LF-260N

Image coming soon

LF-305, LF-310

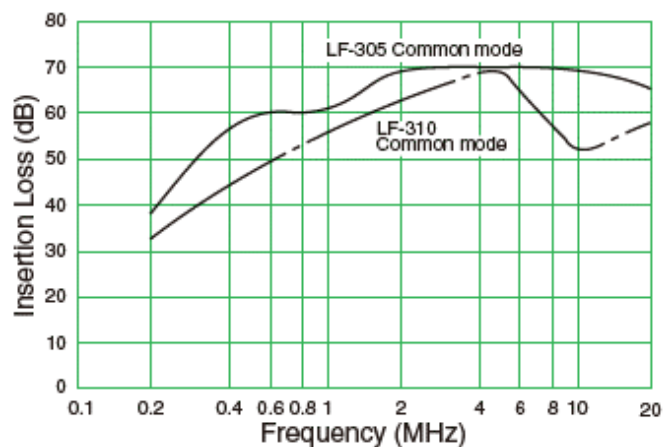

LF-315, LF-320

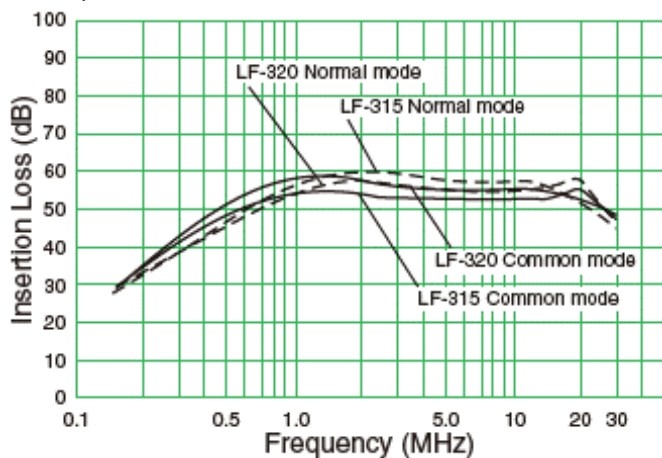

LF-330, LF-340

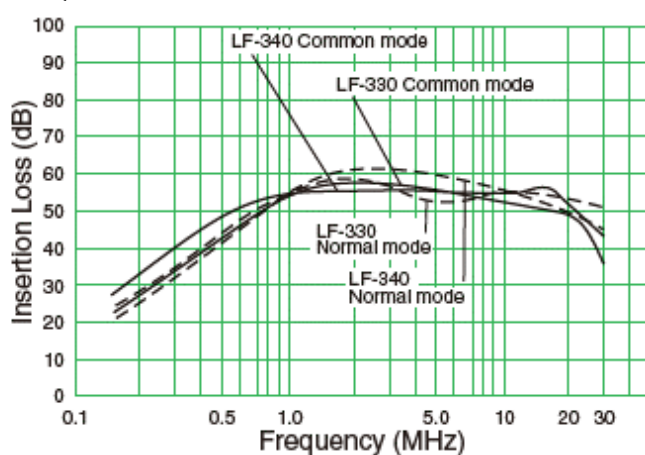

Packaging

Part Type	Packaging Type	Pieces per Box
LF-202U-1	Tray	60
LF-210		
LF-210N		
LF-215N		15
LF-215U		
LF-220N		
LF-230N		12
LF-240		
LF-240P		
LF-250		5
LF-250P		
LF-260N		2
LF-305		16
LF-310		
LF-315		
LF-320		7
LF-330		
LF-340		3
LF-202-9		10
LF-215F		5

Handling Precautions

Precautions for product storage

EMI-RFI Filters should be stored in normal working environments. While the filters themselves are quite robust in other environments, solderability will be degraded by exposure to high temperatures, high humidity, corrosive atmospheres, and long term storage.

KEMET recommends that maximum storage temperature not exceed 40°C and maximum storage humidity not exceed 70% relative humidity and atmospheres should be free of chlorine and sulfur bearing compounds. Temperature fluctuations should be minimized to avoid condensation on the parts. Also, avoid storage near strong magnetic fields as this might magnetize the product.

For optimized solderability, EMI-RFI Filters' stock should be used promptly, preferably within 6 months of receipt.

Export Control

For customers in Japan

For products which are controlled items subject to the "Foreign Exchange and Foreign Trade Law" of Japan, the export license specified by the law is required for export.

For customers outside Japan

EMI-RFI Filters should not be used or sold for use in the development, production, stockpiling, or utilization of any conventional weapons or mass-destructive weapons (nuclear weapons, chemical or biological weapons, or missiles), or any other weapons.

KEMET Electronics Corporation Sales Offices

For a complete list of our global sales offices, please visit www.kemet.com/sales.

Disclaimer

All product specifications, statements, information and data (collectively, the "Information") in this datasheet are subject to change. The customer is responsible for checking and verifying the extent to which the Information contained in this publication is applicable to an order at the time the order is placed. All Information given herein is believed to be accurate and reliable, but it is presented without guarantee, warranty, or responsibility of any kind, expressed or implied.

Statements of suitability for certain applications are based on KEMET Electronics Corporation's ("KEMET") knowledge of typical operating conditions for such applications, but are not intended to constitute – and KEMET specifically disclaims – any warranty concerning suitability for a specific customer application or use. The Information is intended for use only by customers who have the requisite experience and capability to determine the correct products for their application. Any technical advice inferred from this Information or otherwise provided by KEMET with reference to the use of KEMET's products is given gratis, and KEMET assumes no obligation or liability for the advice given or results obtained.

Although KEMET designs and manufactures its products to the most stringent quality and safety standards, given the current state of the art, isolated component failures may still occur. Accordingly, customer applications which require a high degree of reliability or safety should employ suitable designs or other safeguards (such as installation of protective circuitry or redundancies) in order to ensure that the failure of an electrical component does not result in a risk of personal injury or property damage.

Although all product-related warnings, cautions and notes must be observed, the customer should not assume that all safety measures are indicated or that other measures may not be required.

KEMET is a registered trademark of KEMET Electronics Corporation.