

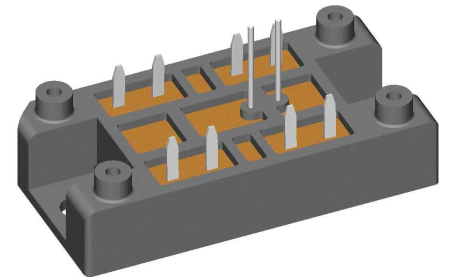
# Standard Rectifier Module

3~ Rectifier	Brake Chopper
$V_{RRM} = 1200\text{ V}$	$V_{CES} = 1200\text{ V}$
$I_{DAV} = 75\text{ A}$	$I_{C25} = 58\text{ A}$
$I_{FSM} = 600\text{ A}$	$V_{CE(sat)} = 1.85\text{ V}$

## 3~ Rectifier Bridge + Brake Unit + NTC

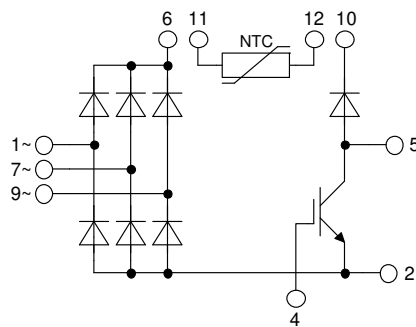
Part number

**VUB72-12NOXT**



Backside: isolated

 E72873



### Features / Advantages:

- Package with DCB ceramic base plate
- Improved temperature and power cycling
- Planar passivated chips
- Very low forward voltage drop
- Very low leakage current
- NTC

### Applications:

- 3~ Rectifier with brake unit for drive inverters

### Package: V1-A-Pack

- Isolation Voltage: 3600 V~
- Industry standard outline
- RoHS compliant
- Soldering pins for PCB mounting
- Height: 17 mm
- Base plate: DCB ceramic
- Reduced weight
- Advanced power cycling

### Disclaimer Notice

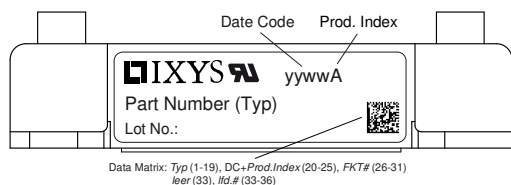
Information furnished is believed to be accurate and reliable. However, users should independently evaluate the suitability of and test each product selected for their own applications. Littelfuse products are not designed for, and may not be used in, all applications. Read complete Disclaimer Notice at [www.littelfuse.com/disclaimer-electronics](http://www.littelfuse.com/disclaimer-electronics).

Rectifier				Ratings			
Symbol	Definition	Conditions		min.	typ.	max.	Unit
$V_{RSM}$	max. non-repetitive reverse blocking voltage					1300	V
$V_{RRM}$	max. repetitive reverse blocking voltage					1200	V
$I_R$	reverse current	$V_R = 1200$ V	$T_{VJ} = 25^\circ\text{C}$			40	$\mu\text{A}$
		$V_R = 1200$ V	$T_{VJ} = 150^\circ\text{C}$			1.5	mA
$V_F$	forward voltage drop	$I_F = 25$ A	$T_{VJ} = 25^\circ\text{C}$			1.10	V
		$I_F = 75$ A				1.38	V
		$I_F = 25$ A	$T_{VJ} = 125^\circ\text{C}$			1.01	V
		$I_F = 75$ A				1.37	V
$I_{DAV}$	bridge output current	$T_C = 110^\circ\text{C}$ rectangular	$T_{VJ} = 150^\circ\text{C}$ $d = \frac{1}{3}$			75	A
$V_{FO}$	threshold voltage	} for power loss calculation only				0.79	V
$r_F$	slope resistance					7.7	m $\Omega$
$R_{thJC}$	thermal resistance junction to case					1.1	K/W
$R_{thCH}$	thermal resistance case to heatsink				0.3		K/W
$P_{tot}$	total power dissipation			$T_C = 25^\circ\text{C}$		110	W
$I_{FSM}$	max. forward surge current	$t = 10$ ms; (50 Hz), sine	$T_{VJ} = 45^\circ\text{C}$			600	A
		$t = 8,3$ ms; (60 Hz), sine	$V_R = 0$ V			650	A
		$t = 10$ ms; (50 Hz), sine	$T_{VJ} = 150^\circ\text{C}$			510	A
		$t = 8,3$ ms; (60 Hz), sine	$V_R = 0$ V			550	A
$I^2t$	value for fusing	$t = 10$ ms; (50 Hz), sine	$T_{VJ} = 45^\circ\text{C}$			1.80	kA <sup>2</sup> s
		$t = 8,3$ ms; (60 Hz), sine	$V_R = 0$ V			1.76	kA <sup>2</sup> s
		$t = 10$ ms; (50 Hz), sine	$T_{VJ} = 150^\circ\text{C}$			1.30	kA <sup>2</sup> s
		$t = 8,3$ ms; (60 Hz), sine	$V_R = 0$ V			1.26	kA <sup>2</sup> s
$C_J$	junction capacitance	$V_R = 400$ V; $f = 1$ MHz		$T_{VJ} = 25^\circ\text{C}$		19	pF

Brake IGBT				Ratings					
Symbol	Definition	Conditions	min.	typ.	max.	Unit			
$V_{CES}$	collector emitter voltage	$T_{VJ} = 25^{\circ}\text{C}$			1200	V			
$V_{GES}$	max. DC gate voltage				$\pm 20$	V			
$V_{GEM}$	max. transient gate emitter voltage				$\pm 30$	V			
$I_{C25}$	collector current	$T_C = 25^{\circ}\text{C}$			58	A			
$I_{C80}$		$T_C = 80^{\circ}\text{C}$			40	A			
$P_{tot}$	total power dissipation	$T_C = 25^{\circ}\text{C}$			195	W			
$V_{CE(sat)}$	collector emitter saturation voltage	$I_C = 35\text{ A}; V_{GE} = 15\text{ V}$			1.85	V			
					2.15	V			
$V_{GE(th)}$	gate emitter threshold voltage	$I_C = 2\text{ mA}; V_{GE} = V_{CE}$	5.4	5.9	6.5	V			
$I_{CES}$	collector emitter leakage current	$V_{CE} = V_{CES}; V_{GE} = 0\text{ V}$			0.1	mA			
					0.1	mA			
$I_{GES}$	gate emitter leakage current	$V_{GE} = \pm 20\text{ V}$			500	nA			
$Q_{G(on)}$	total gate charge	$V_{CE} = 600\text{ V}; V_{GE} = 15\text{ V}; I_C = 35\text{ A}$			110	nC			
$t_{d(on)}$	turn-on delay time	inductive load $V_{CE} = 600\text{ V}; I_C = 35\text{ A}$ $V_{GE} = \pm 15\text{ V}; R_G = 27\ \Omega$							
$t_r$	current rise time						$T_{VJ} = 125^{\circ}\text{C}$	70	ns
$t_{d(off)}$	turn-off delay time						40	ns	
$t_f$	current fall time						250	ns	
$E_{on}$	turn-on energy per pulse						100	ns	
$E_{off}$	turn-off energy per pulse						3.8	mJ	
$E_{off}$		4.1	mJ						
<b>RBSOA</b>	reverse bias safe operating area	$V_{GE} = \pm 15\text{ V}; R_G = 27\ \Omega$							
$I_{CM}$		$V_{CEK} = 1200\text{ V}$			105	A			
<b>SCSOA</b>	short circuit safe operating area	$V_{CEK} = 1200\text{ V}$							
$t_{SC}$	short circuit duration	$V_{CE} = 900\text{ V}; V_{GE} = \pm 15$			10	$\mu\text{s}$			
$I_{SC}$	short circuit current	$R_G = 27\ \Omega$ ; non-repetitive			140	A			
$R_{thJC}$	thermal resistance junction to case				0.65	K/W			
$R_{thCH}$	thermal resistance case to heatsink				0.25	K/W			
Brake Diode									
$V_{RRM}$	max. repetitive reverse voltage	$T_{VJ} = 25^{\circ}\text{C}$			1200	V			
$I_{F25}$	forward current	$T_C = 25^{\circ}\text{C}$			31	A			
$I_{F80}$		$T_C = 80^{\circ}\text{C}$			21	A			
$V_F$	forward voltage	$I_F = 25\text{ A}$			2.97	V			
					2.43	V			
$I_R$	reverse current	$V_R = V_{RRM}$			0.1	mA			
					0.5	mA			
$Q_{rr}$	reverse recovery charge	$V_R = 600\text{ V}$ $-di_f/dt = 400\text{ A}/\mu\text{s}$ $I_F = 25\text{ A}; V_{GE} = 0\text{ V}$							
$I_{RM}$	max. reverse recovery current						$T_{VJ} = 125^{\circ}\text{C}$	1.2	$\mu\text{C}$
$t_{rr}$	reverse recovery time						18	A	
$R_{thJC}$	thermal resistance junction to case				1.6	K/W			
$R_{thCH}$	thermal resistance case to heatsink				0.55	K/W			



Package V1-A-Pack				Ratings		
Symbol	Definition	Conditions	min.	typ.	max.	Unit
$I_{RMS}$	RMS current	per terminal			100	A
$T_{VJ}$	virtual junction temperature		-40		150	°C
$T_{op}$	operation temperature		-40		125	°C
$T_{stg}$	storage temperature		-40		125	°C
<b>Weight</b>				37		g
$M_D$	mounting torque		2		2.5	Nm
$d_{Spp/APP}$	creepage distance on surface / striking distance through air	terminal to terminal	6.0			mm
$d_{Spb/APb}$		terminal to backside	12.0			mm
$V_{ISOL}$	isolation voltage	t = 1 second 50/60 Hz, RMS; $I_{ISOL} \leq 1$ mA	3600			V
		t = 1 minute	3000			V



Ordering	Ordering Number	Marking on Product	Delivery Mode	Quantity	Code No.
Standard	VUB72-12NOXT	VUB72-12NOXT	Blister	24	515901

Similar Part	Package	Voltage class
VUB72-16NOXT	V1-A-Pack	1600

**Temperature Sensor NTC**

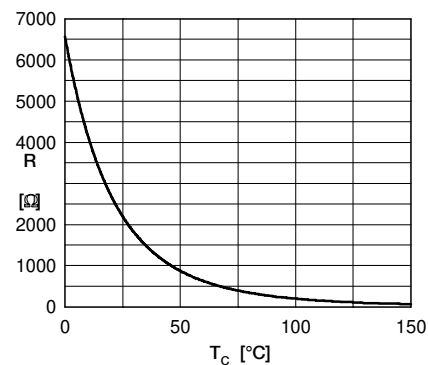
Symbol	Definition	Conditions	min.	typ.	max.	Unit
$R_{25}$	resistance	$T_{VJ} = 25^\circ$	2.13	2.2	2.27	kΩ
$B_{25/50}$	temperature coefficient			3560		K

**Equivalent Circuits for Simulation**

\* on die level

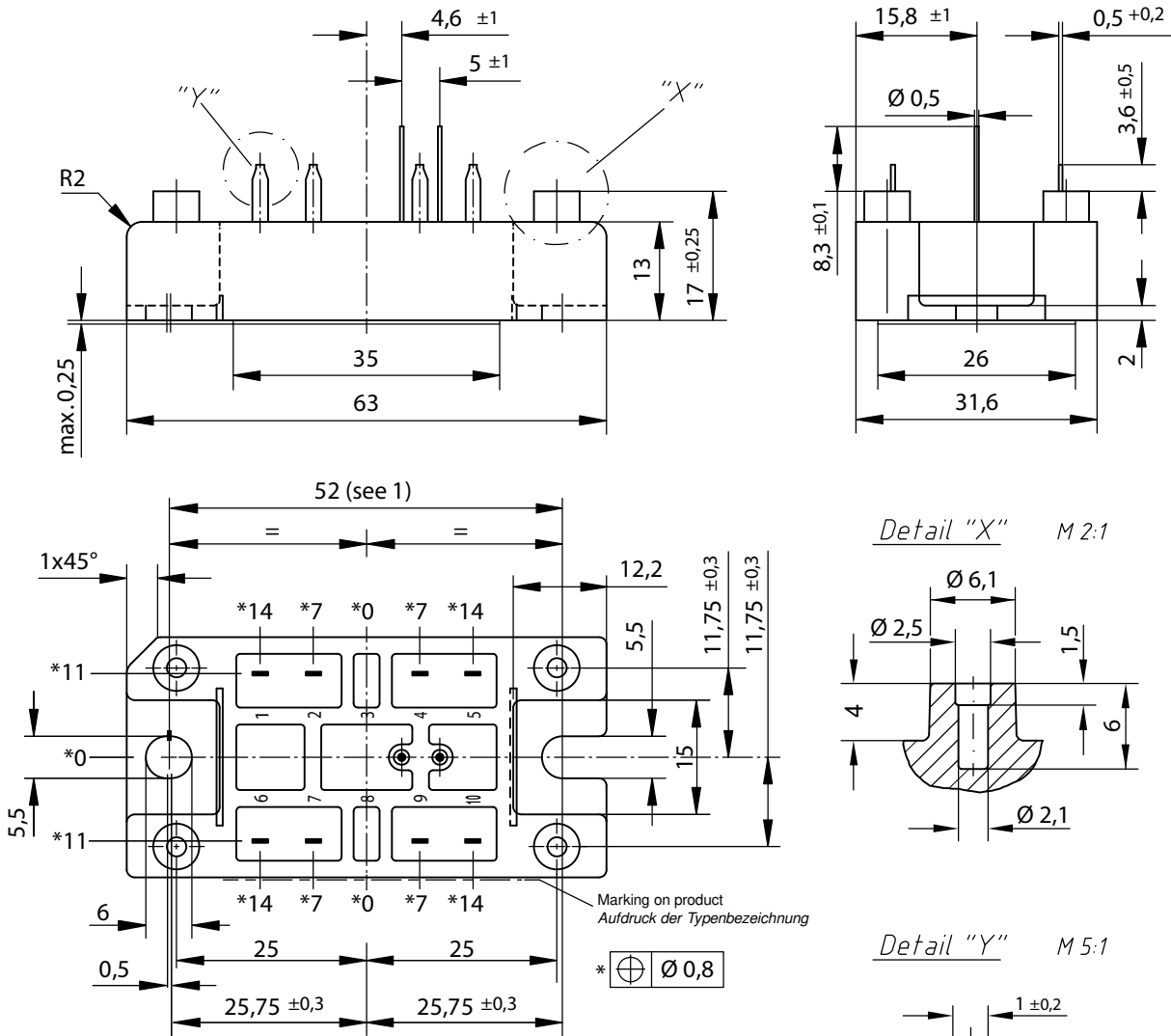
$T_{VJ} = 150^\circ\text{C}$

		Rectifier	Brake IGBT	Brake Diode	
$V_0$	threshold voltage	0.79	1.1	1.16	V
$R_0$	slope resistance *	6.5	40	43	mΩ



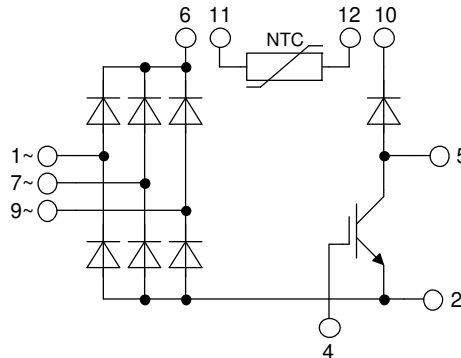


**Outlines V1-A-Pack**



**Remarks / Bemerkungen:**

1. Nominal distance mounting screws on heat sink: 52 mm / Nennabstand Befestigungsschrauben auf Kühlkörper: 52 mm
2. General tolerance / Allgmeintoleranz: DIN ISO 2768 - T1-c
3. Surface treatment of pins: tin plated (Sn) in hot dip / Oberflächenbehandlung der Pins: verzinkt (Sn) im Tauchbad
4. **Detail X:**  
EJOT PT® self-tapping screws (dimension K25) to be recommended for mounting on PCB  
selbstschneidende Schraube (Größe K25) empfohlen für die PCB-Montage  
Take care on the maximum screw length according to board thickness and the maximum hole depth of 6 mm<sup>-1</sup>  
Bei der Wahl der Schraubenlänge die PCB-Dicke und die maximale Lochtiefe von 6mm beachten  
Recommended mounting torque: 1.5 Nm / Empfohlenes Drehmoment: 1.5 Nm





**Rectifier**

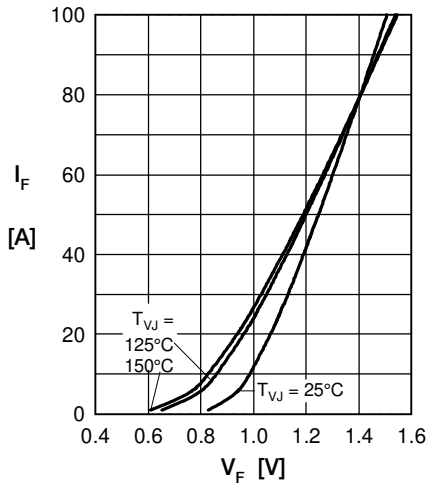


Fig. 1 Forward current vs. voltage drop per diode

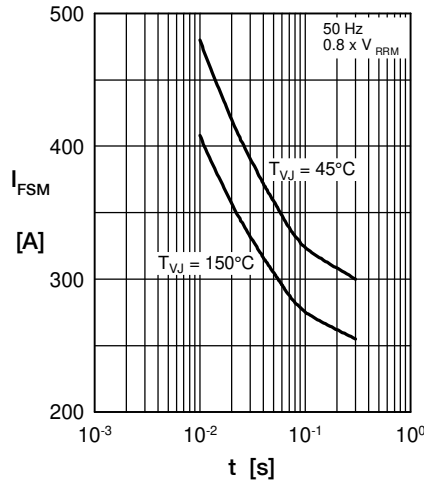


Fig. 2 Surge overload current vs. time per diode

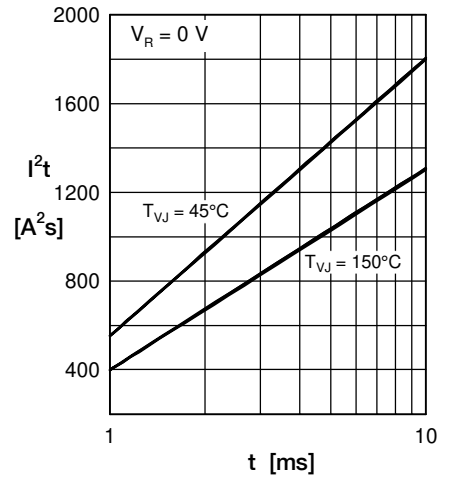


Fig. 3  $I^2t$  vs. time per diode

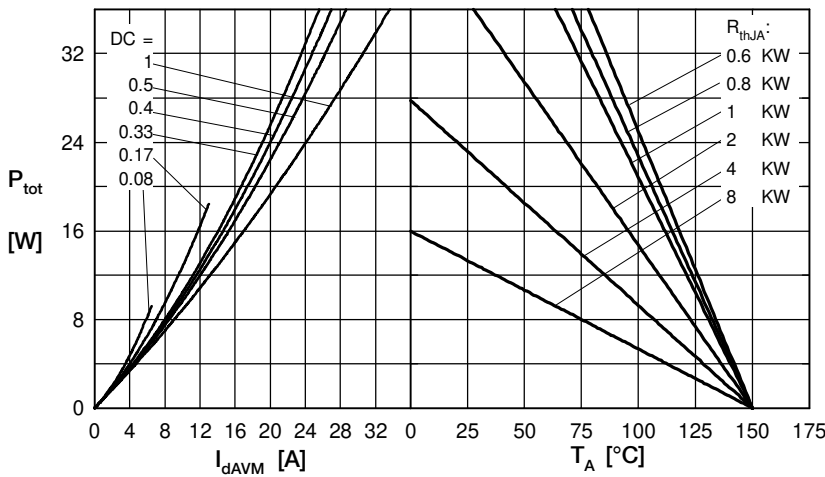


Fig. 4 Power dissipation vs. forward current and ambient temperature per diode

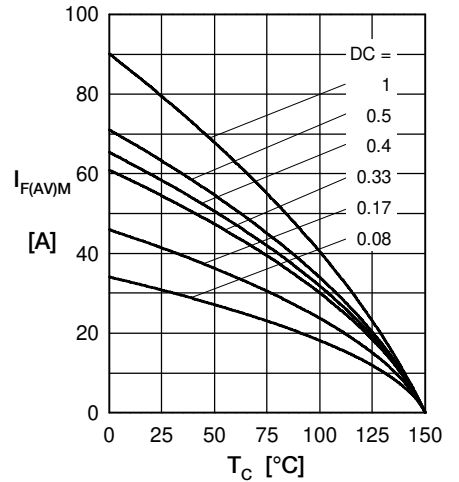


Fig. 5 Max. forward current vs. case temperature per diode

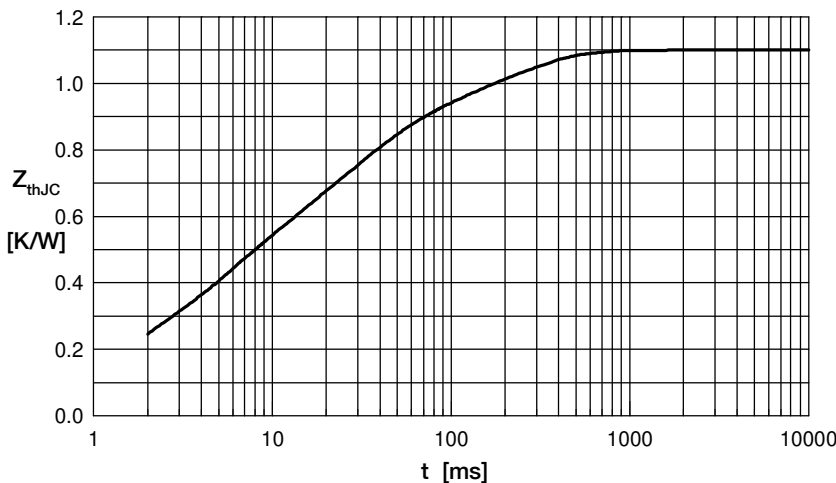


Fig. 6 Transient thermal impedance junction to case vs. time per diode

Constants for  $Z_{thJC}$  calculation:

i	$R_{th}$ (K/W)	$t_i$ (s)
1	0.0607	0.0004
2	0.1230	0.00256
3	0.2305	0.0045
4	0.4230	0.0242
5	0.2628	0.1800

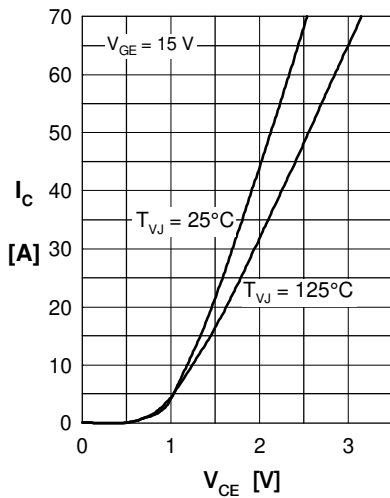
**Brake IGBT**


Fig. 1 Typ. output characteristics

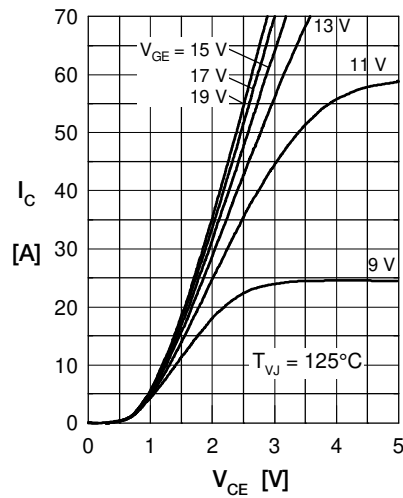


Fig. 2 Typ. output characteristics

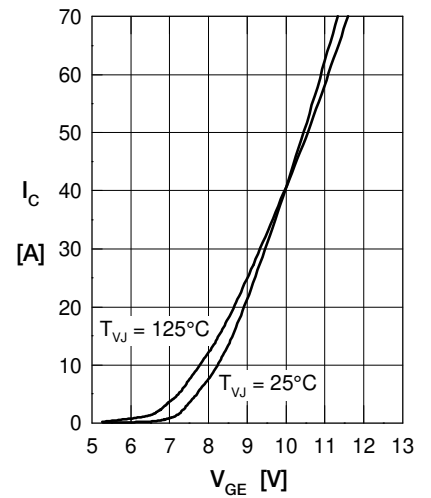


Fig. 3 Typ. transfer characteristics

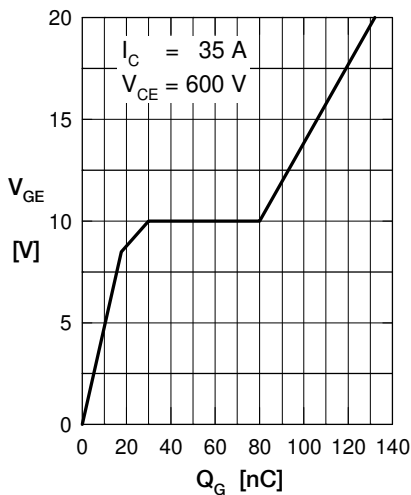


Fig. 4 Typ. turn-on gate charge

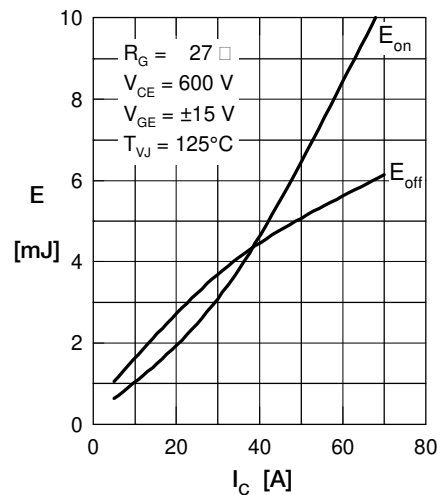


Fig. 5 Typ. switching energy versus collector current

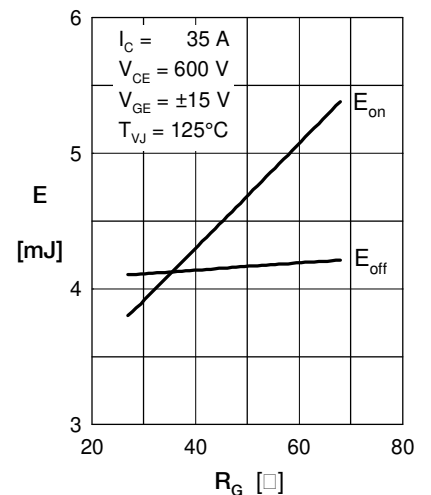


Fig. 6 Typ. switching energy versus gate resistance

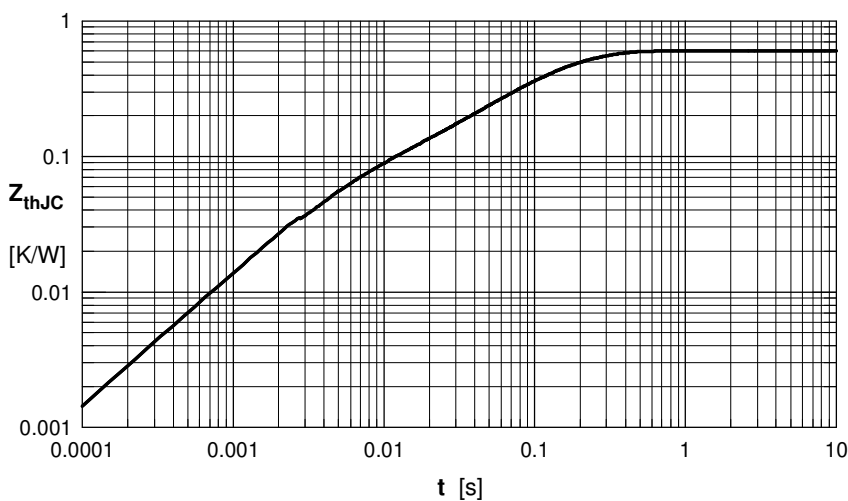


Fig. 7 Typ. transient thermal impedance

**Brake Diode**

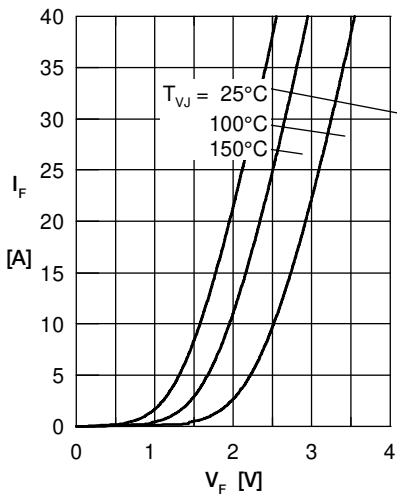


Fig. 1 Forward current  $I_F$  versus  $V_F$

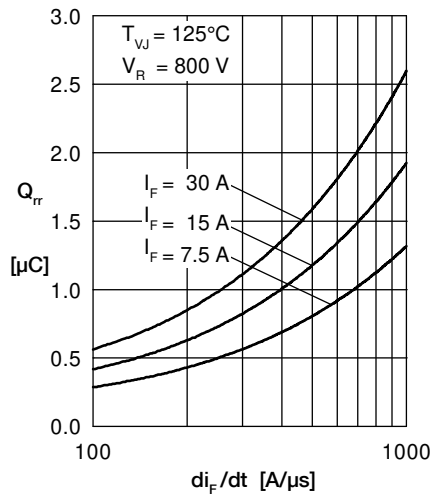


Fig. 2 Typ. reverse recov. charge  $Q_{rr}$  versus  $di_F/dt$

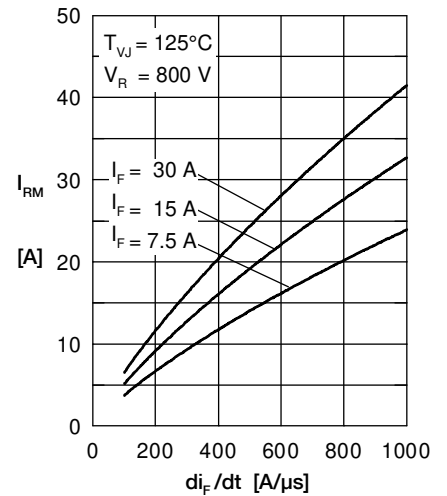


Fig. 3 Typ. peak reverse current  $I_{RM}$  versus  $di_F/dt$

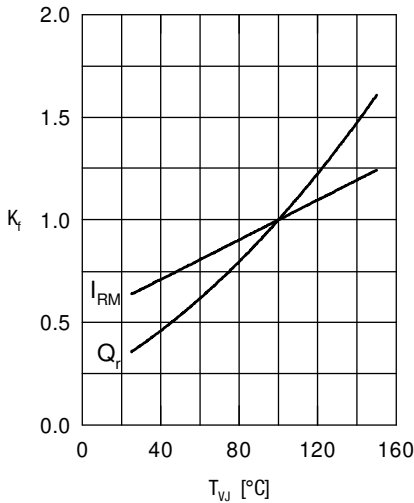


Fig. 4 Dynamic parameters  $Q_r$ ,  $I_{RM}$  versus  $T_{VJ}$

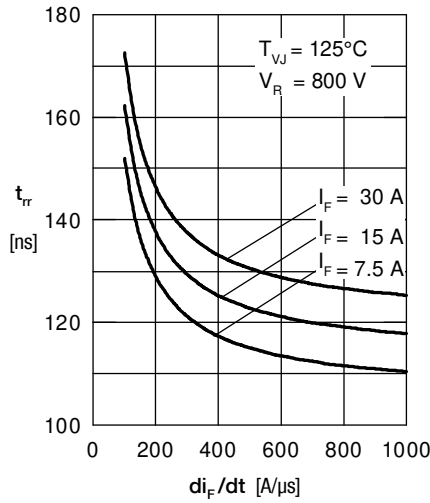


Fig. 5 Typ. recovery time  $t_{rr}$  versus  $di_F/dt$

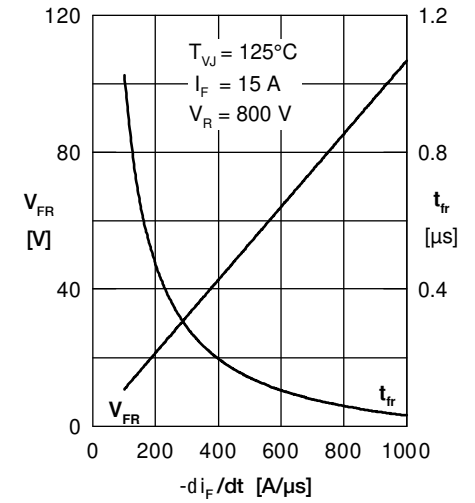


Fig. 6 Typ. peak forward voltage  $V_{FR}$  and  $t_{fr}$  versus  $di_F/dt$

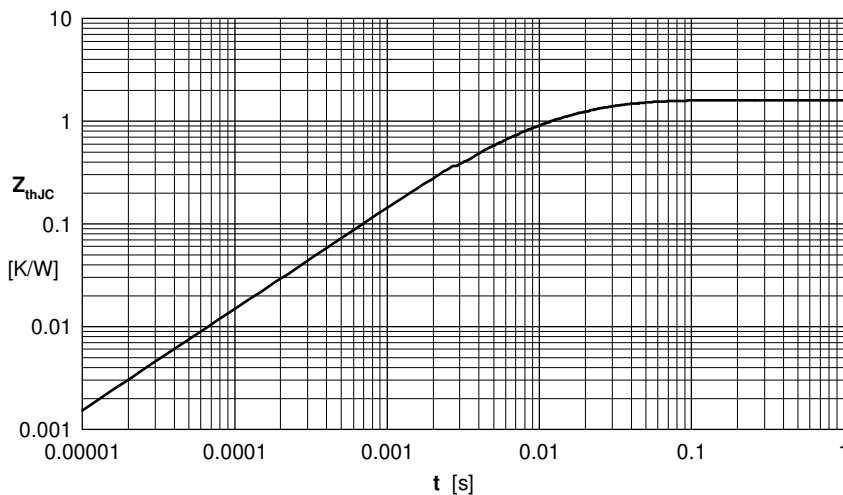


Fig. 7 Transient thermal impedance junction to case