

N-Channel Enhancement Mode Switch Mode RF MOSFET
 Low Capacitance Z-MOS™ MOSFET Process
 Optimized for RF Operation
 Ideal for Class C, D, & E Applications

$V_{DSS} = 600\text{ V}$
 $I_{D25} = 18\text{ A}$
 $R_{DS(on)} \leq 0.56\ \Omega$
 $P_{DC} = 350$

Symbol	Test Conditions	Maximum Ratings	
V_{DSS}	$T_J = 25^\circ\text{C}$ to 150°C	600	V
V_{DGR}	$T_J = 25^\circ\text{C}$ to 150°C ; $R_{GS} = 1\text{ M}\Omega$	600	V
V_{GS}	Continuous	± 20	V
V_{GSM}	Transient	± 30	V
I_{D25}	$T_c = 25^\circ\text{C}$	18	A
I_{DM}	$T_c = 25^\circ\text{C}$, pulse width limited by T_{JM}	90	A
I_{AR}	$T_c = 25^\circ\text{C}$	18	A
E_{AR}	$T_c = 25^\circ\text{C}$	TBD	mJ
dv/dt	$I_S \leq I_{DM}$, $di/dt \leq 100\text{A}/\mu\text{s}$, $V_{DD} \leq V_{DSS}$, $T_J \leq 150^\circ\text{C}$, $R_G = 0.2\ \Omega$	5	V/ns
	$I_S = 0$	>200	V/ns
P_{DC}		350	W
P_{DHS}	$T_c = 25^\circ\text{C}$, Derate $4.4\text{W}/^\circ\text{C}$ above 25°C	TBD	W
P_{DAMB}	$T_c = 25^\circ\text{C}$	3.0	W
R_{thJC}		TBD	C/W
R_{thJHS}		TBD	C/W

ISOPLUS 247™
 E153432

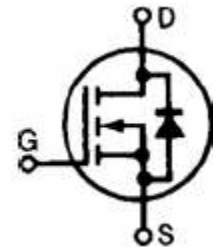
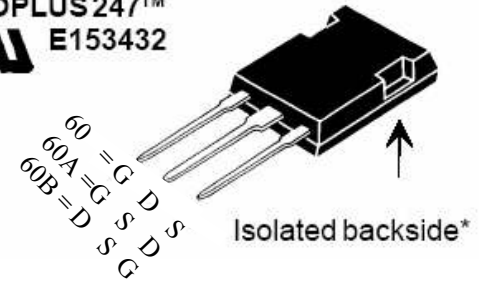

Symbol	Test Conditions	Characteristic Values		
		$(T_J = 25^\circ\text{C}$ unless otherwise specified)		
		min.	typ.	max.
V_{DSS}	$V_{GS} = 0\text{ V}$, $I_D = 4\text{ ma}$	600		
$V_{GS(th)}$	$V_{DS} = V_{GS}$, $I_D = 250\ \mu\text{A}$		4.6	
I_{GSS}	$V_{GS} = \pm 20\text{ V}_{DC}$, $V_{DS} = 0$			± 100
I_{DSS}	$V_{DS} = 0.8V_{DSS}$ $V_{GS} = 0$	$T_J = 25^\circ\text{C}$		50
		$T_J = 125^\circ\text{C}$		1
$R_{DS(on)}$	$V_{GS} = 20\text{ V}$, $I_D = 0.5I_{D25}$ Pulse test, $t \leq 300\ \mu\text{s}$, duty cycle $d \leq 2\%$		0.53	
g_{fs}	$V_{DS} = 50\text{ V}$, $I_D = 0.5I_{D25}$, pulse test		6.4	
T_J		-55		+175
T_{JM}			175	
T_{stg}		-55		+175
T_L	1.6mm(0.063 in) from case for 10 s		300	
Weight			3.5	

Features

- Isolated Substrate
 - high isolation voltage (>2500V)
 - excellent thermal transfer
 - Increased temperature and power cycling capability
- IXYS advanced Z-MOS process
- Low gate charge and capacitances
 - easier to drive
 - faster switching
- Low $R_{DS(on)}$
- Very low insertion inductance (<2nH)
- No beryllium oxide (BeO) or other hazardous materials

Advantages

- High Performance RF Z-MOS™
- Optimized for RF and high speed
- Common Source RF Package
 - A = Gate Source Drain
 - B = Drain Source Gate
- Isolated Package, no insulator required



IXZR16N60 & IXZR16N60A/B Z-MOS RF Power MOSFET

Symbol	Test Conditions	Characteristic Values ($T_J = 25^\circ\text{C}$ unless otherwise specified)		
		min.	typ.	max.
R_G				1 Ω
C_{iss}			2040	pF
C_{oss}	$V_{GS} = 0\text{ V}, V_{DS} = 0.8 V_{DSS(max)},$ $f = 1\text{ MHz}$		160	pF
C_{rss}			20	pF
C_{stray}	Back Metal to any Pin		33	pF
$T_{d(on)}$			4	ns
T_{on}	$V_{GS} = 15\text{ V}, V_{DS} = 0.8 V_{DSS}$ $I_D = 0.5 I_{DM}$		4	ns
$T_{d(off)}$	$R_G = 1\ \Omega$ (External)		4	ns
T_{off}			6	ns
$Q_{g(on)}$			42	nC
Q_{gs}	$V_{GS} = 10\text{ V}, V_{DS} = 0.5 V_{DSS}$ $I_D = 0.5 I_{D25} \quad I_G = 3\text{mA}$		13	nC
Q_{gd}			18	nC

Source-Drain Diode

Characteristic Values

($T_J = 25^\circ\text{C}$ unless otherwise specified)

Symbol	Test Conditions	min.	typ.	max.
I_S	$V_{GS} = 0\text{ V}$			18 A
I_{SM}	Repetitive; pulse width limited by T_{JM}			108 A
V_{SD}	$I_F = I_S, V_{GS} = 0\text{ V},$ Pulse test, $t \leq 300\ \mu\text{s},$ duty cycle $\leq 2\%$			1.5 V
T_{rr}			200	ns

CAUTION: Operation at or above the Maximum Ratings values may impact device reliability or cause permanent damage to the device.

Information in this document is believed to be accurate and reliable. IXYSRF reserves the right to make changes to information published in this document at any time and without notice.

IXYS RF reserves the right to change limits, test conditions and dimensions.

IXYS RF MOSFETS are covered by one or more of the following U.S. patents:

4,835,592 4,860,072 4,881,106 4,891,686 4,931,844 5,017,508
 5,034,796 5,049,961 5,063,307 5,187,117 5,237,481 5,486,715
 5,381,025 5,640,045 6,404,065 6,583,505 6,710,463 6,727,585
 6,731,002

Fig. 1

Gate Charge vs. Gate-to-Source Voltage
 $V_{DS} = 300V$, $I_D = 9A$, $I_G = 3mA$

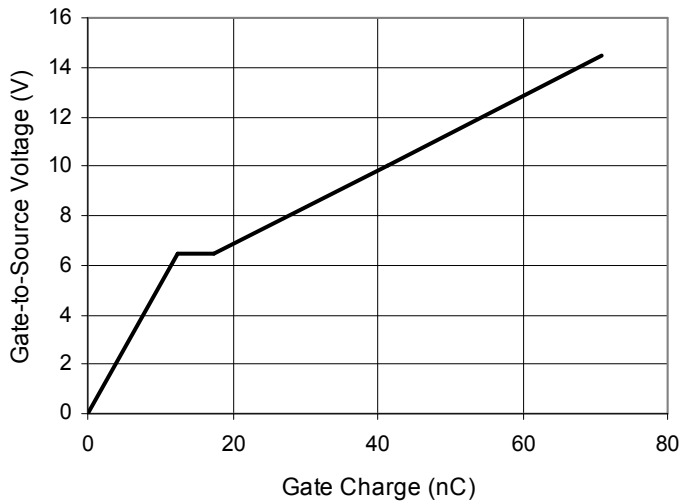

Fig. 2

Typical Output Characteristics

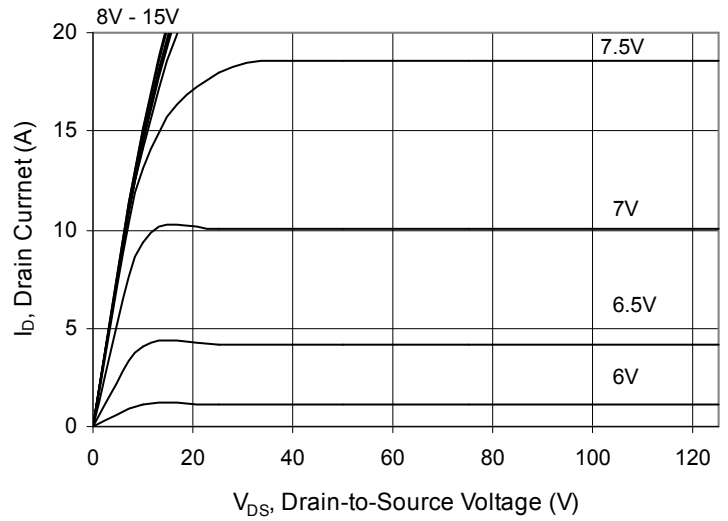

Fig. 3

Typical Transfer Characteristics
 $V_{DS} = 50V$

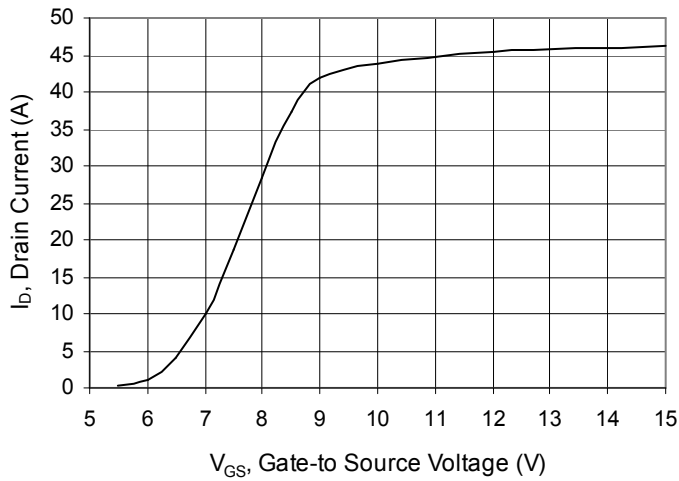

Fig. 4

Extended Typical Output Characteristics

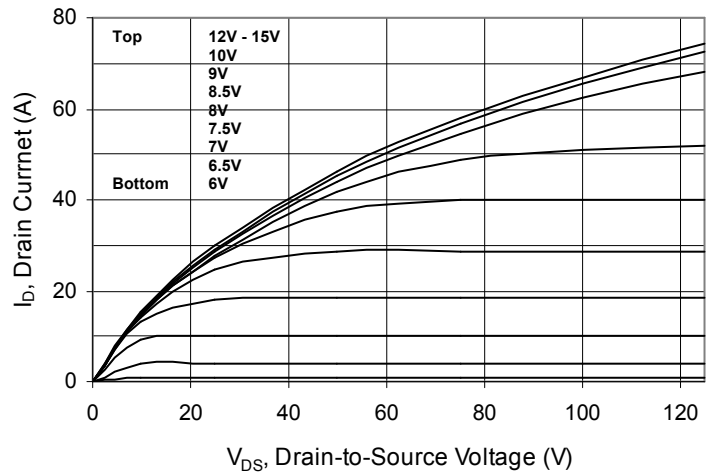

Fig. 5

V_{DS} vs. Capacitance

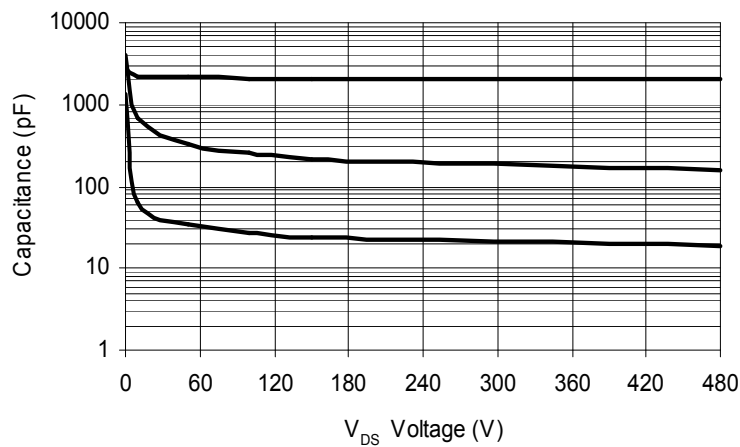
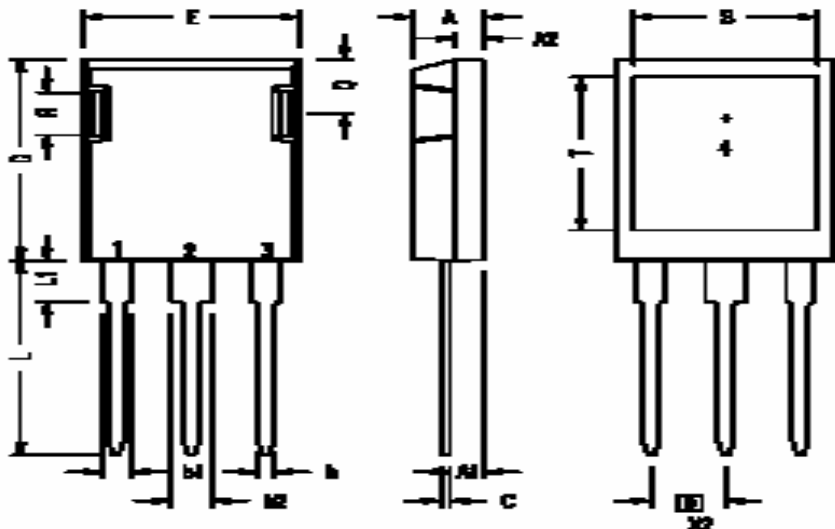

Fig. 6 Package Drawing

ISOPLUS 247 OUTLINE



60: 1=G, 2=D, 3=S
 60A: 1=G, 2=S, 3=D
 60B: 1=D, 2=S, 3=G



1 Gate, 2 Drain (Collector)
 3 Source (Emitter)
 4 no connection

Dim.	Millimeter		Inches	
	Min.	Max.	Min.	Max.
A	4.83	5.21	.190	.205
A ₁	2.29	2.54	.090	.100
A ₂	1.91	2.16	.075	.085
b	1.14	1.40	.045	.055
b ₁	1.91	2.13	.075	.084
b ₂	2.92	3.12	.115	.123
C	0.61	0.80	.024	.031
D	20.80	21.34	.819	.840
E	15.75	16.13	.620	.635
e	5.45 BSC		.215 BSC	
L	19.81	20.32	.780	.800
L1	3.81	4.32	.150	.170
Q	5.59	6.20	.220	.244
R	4.32	4.83	.170	.190

Doc #dsIXZR16N60_A/B REV 08/09
 © 2009 IXYS RF