

Schottky Diode

High Performance Schottky Diode
 Low Loss and Soft Recovery
 Common Cathode

$V_{RRM} = 30\text{ V}$
 $I_{FAV} = 2 \times 25\text{ A}$
 $V_F = 0.35\text{ V}$

Part number

DSSK48-003BS

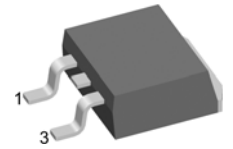
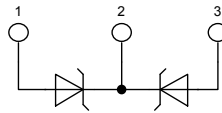

Backside: cathode

Features / Advantages:

- Very low V_f
- Extremely low switching losses
- low I_{rm} values
- Improved thermal behaviour
- High reliability circuit operation
- Low voltage peaks for reduced protection circuits
- Low noise switching

Applications:

- Rectifiers in switch mode power supplies (SMPS)
- Free wheeling diode in low voltage converters

Package:

- Housing: TO-263 (D2Pak)
- Industry standard outline
- Epoxy meets UL 94V-0
- RoHS compliant

Symbol	Definition	Conditions	Ratings			Unit
			min.	typ.	max.	
V_{RRM}	max. repetitive reverse voltage				30	V
I_R	reverse current	$V_R = 30\text{ V}$			20	mA
		$V_R = 30\text{ V}$			60	mA
V_F	forward voltage	$I_F = 20\text{ A}$			0.44	V
		$I_F = 40\text{ A}$			0.54	V
		$I_F = 20\text{ A}$			0.35	V
		$I_F = 40\text{ A}$			0.48	V
I_{FAV}	average forward current	rectangular d = 0.5			25	A
V_{F0}	threshold voltage				0.19	V
r_F	slope resistance					
R_{thJC}	thermal resistance junction to case				1.20	K/W
T_{VJ}	virtual junction temperature		-55		150	°C
P_{tot}	total power dissipation				105	W
I_{FSM}	max. forward surge current	t = 10 ms (50 Hz), sine			300	A
C_J	junction capacitance	$V_R = 5\text{ V}; f = 1\text{ MHz}$		1.77		nF

Symbol	Definition	Conditions	Ratings			Unit
			min.	typ.	max.	
I_{RMS}	RMS current	per pin ¹⁾			35	A
R_{thCH}	thermal resistance case to heatsink			0.25		K/W
T_{stg}	storage temperature		-55		150	°C
Weight				2		g
F_c	mounting force with clip		20		60	N

¹⁾ I_{RMS} is typically limited by: 1. pin-to-chip resistance; or by 2. current capability of the chip.
 In case of 1, a common cathode/anode configuration and a non-isolated backside, the whole current capability can be used by connecting the backside.

Product Marking

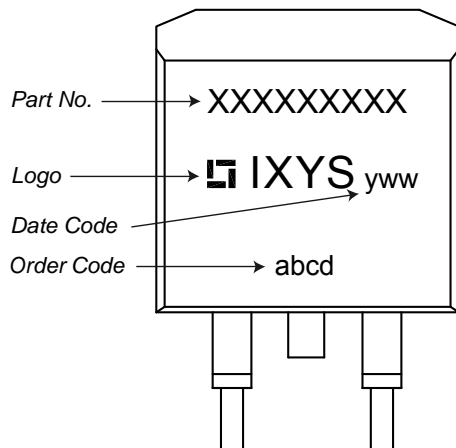

Ordering	Part Name	Marking on Product	Delivering Mode	Base Qty	Code Key
Standard	DSSK48-003BS	DSSK48-003BS	Tape & Reel	800	484326

Similar Part	Package	Voltage class
DSSK48-003B	TO-220AB (3)	30
DSSK48-0025B	TO-220AB (3)	25

Outlines TO-263 (D2Pak)

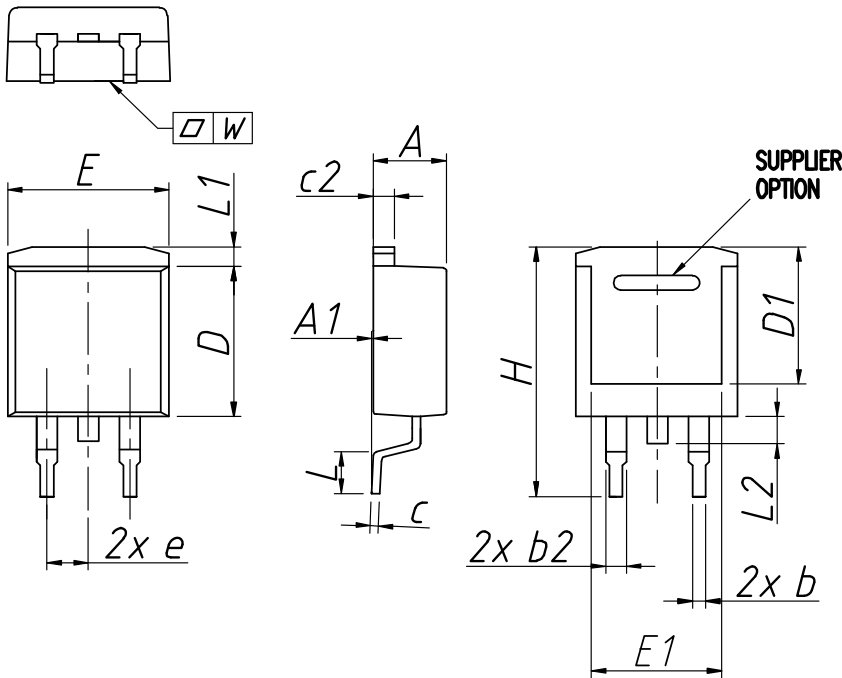

Dim.	Millimeter		Inches	
	min	max	min	max
A	4.06	4.83	0.160	0.190
A1	typ. 0.10		typ. 0.004	
b	0.51	0.99	0.020	0.039
b2	1.14	1.40	0.045	0.055
c	0.40	0.74	0.016	0.029
c2	1.14	1.40	0.045	0.029
D	8.38	9.40	0.330	0.370
D1	8.00	8.89	0.315	0.350
E	9.65	10.41	0.380	0.410
E1	6.22	8.20	0.245	0.323
e	2,54 BSC		0,100 BSC	
H	14.61	15.88	0.575	0.625
L	1.78	2.79	0.070	0.110
L1	1.02	1.68	0.040	0.066
L2	1.02	1.52	0.040	0.060
W	typ. 0.02	0.040	typ. 0.0008	0.0016

All dimensions conform with and/or are within JEDEC standard.

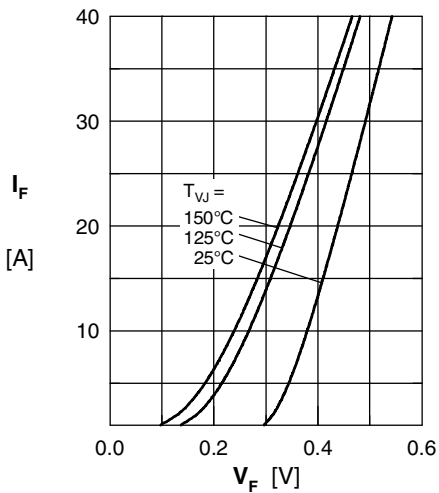

Fig. 1 Maximum forward voltage drop characteristics

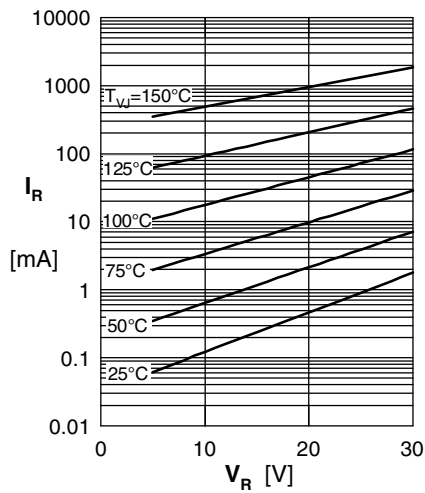

Fig. 2 Typ. reverse current I_R vs. reverse voltage V_R

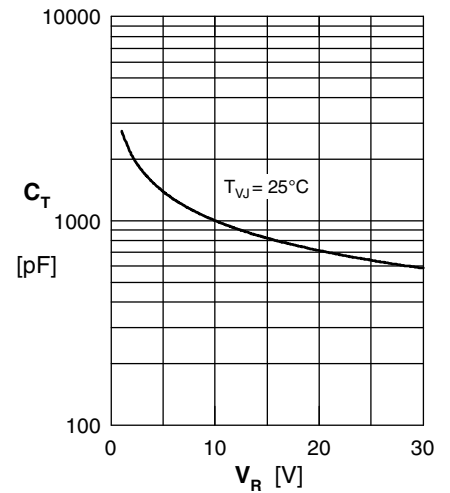

Fig. 3 Typ. junction capacitance C_T vs. reverse voltage V_R

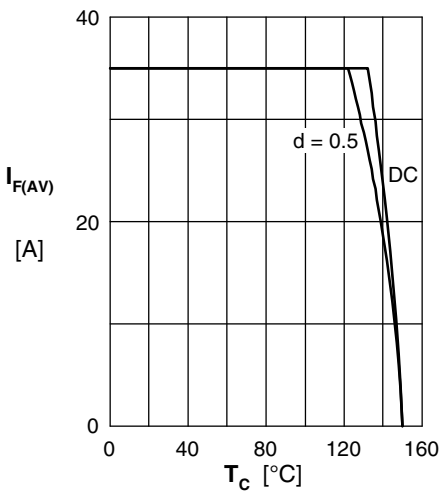

Fig. 4 Average forward current $I_{F(AV)}$ vs. case temperature T_C

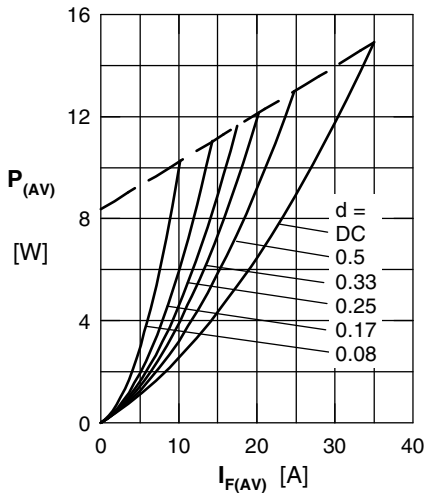

Fig. 5 Forward power loss characteristics

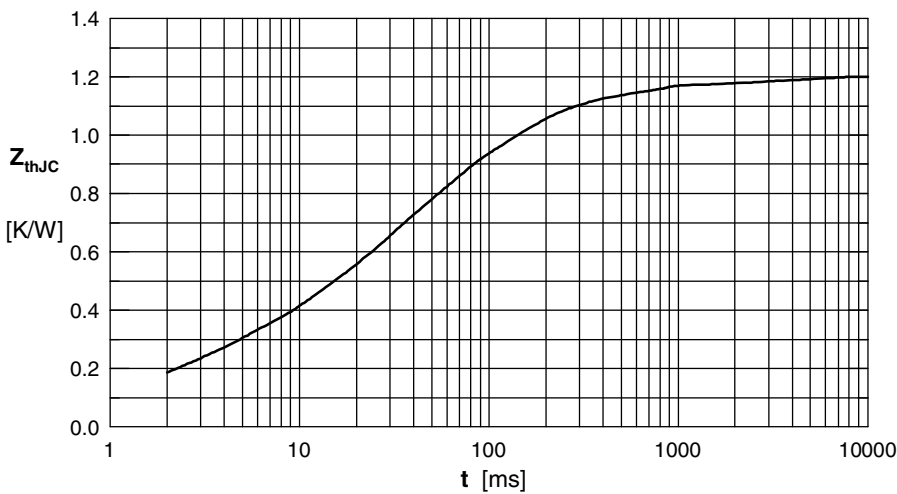

Fig. 6 Transient thermal impedance junction to case at various duty cycles

Note: All curves are per diode