



### Features

- Improved switch dV/dt immunity of 1500 V/μs
- Drop-In Replacement for CPC7595
- Replaces CPC7585, and allows removal of power-up control discrete components
- Enhanced SW8, Ringing Test Switch, breakdown voltage
- TTL logic level inputs for 3.3V logic interfaces
- Smart logic for power up / hot plug state control
- Small 20 pin or 28 pin SOIC Package
- Monolithic IC reliability
- Low, matched,  $R_{ON}$
- Eliminates the need for zero-cross switching
- Flexible switch timing for transition from ringing mode to talk mode.
- Clean, bounce-free switching
- SLIC tertiary protection via integrated current limiting, voltage clamping and thermal shutdown
- 5 V operation with power consumption < 10.5 mW
- Intelligent battery monitor

### Applications

- Standard voice linecards
- Integrated Voice and Data (IVD) linecards
- Central office (CO)
- Digital Loop Carrier (DLC)
- PBX Systems
- Digitally Added Main Line (DAML)
- Fiber in the Loop (FITL)
- Pair Gain System
- Channel Banks

### Description

The CPC7695 is a member of Clare's third-generation Line Card Access Switch (LCAS) family. This monolithic 10-pole line card access switch is available in a 20- or 28-pin SOIC package. It provides the necessary functions to replace three 2-Form-C electromechanical relays on analog line cards or combined voice and data line cards found in central office, access, and PBX equipment. The device contains solid state switches for tip and ring line break, ringing injection and test access. The CPC7695 requires only a +5 V supply and provides stable start up conditioning during system power up and for hot plug insertion. Once active, the inputs respond to traditional TTL logic levels enabling the CPC7695 to be used with 3.3V only logic.

### Ordering Information

CPC7695 part numbers are specified as shown here:  
 B - 28-pin SOIC delivered 29/Tube, 1000/Reel  
 Z - 20-pin SOIC delivered 40/Tube, 1000/Reel

CPC7695 X X XX

TR - Add for Tape & Reel Version

- A - With Protection SCR
- B - Without Protection SCR
- C - With Protection SCR and "Monitor Test State"

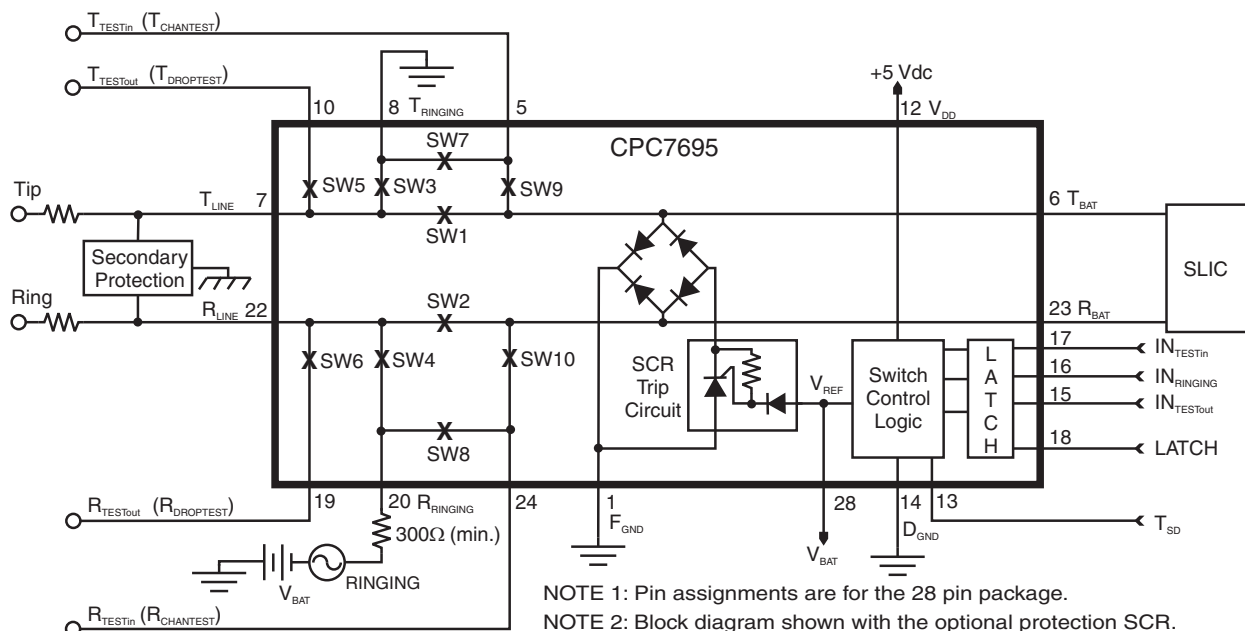

NOTE 1: Pin assignments are for the 28 pin package.

NOTE 2: Block diagram shown with the optional protection SCR.

<b>1. Specifications</b>	<b>3</b>
1.1 Package Pinout	3
1.2 Pinout	3
1.3 Absolute Maximum Ratings	4
1.4 ESD Rating	4
1.5 General Conditions	4
1.6 Switch Specifications	5
1.6.1 Break Switches, SW1 and SW2	5
1.6.2 Ringing Return Switch, SW3	6
1.6.3 Ringing Switch, SW4	7
1.6.4 TESTout Switches, SW5 and SW6	8
1.6.5 Ringing Test Return Switch, SW7	9
1.6.6 Ringing Test Switch, SW8	10
1.6.7 TESTin Switches, SW9 and SW10	11
1.7 Digital I/O Electrical Specifications	12
1.8 Voltage and Power Specifications	13
1.9 Protection Circuitry Electrical Specifications	13
1.10 Truth Tables	14
1.10.1 Truth Table for CPC7695xA and CPC7695xB	14
1.10.2 Truth Table for CPC7695xC	14
<b>2. Functional Description</b>	<b>15</b>
2.1 Introduction	15
2.2 Under Voltage Switch Lock Out Circuitry	15
2.2.1 Introduction	15
2.2.2 Hot Plug and Power Up Circuit Design Considerations	16
2.3 Switch Logic	16
2.3.1 Start-up	16
2.3.2 Switch Timing	16
2.3.3 Make-Before-Break Operation	16
2.3.4 Break-Before-Make Operation	17
2.3.5 Alternate Break-Before-Make Operation	17
2.4 Data Latch	18
2.5 $T_{SD}$ Pin Description	18
2.6 Ringing Switch Zero-Cross Current Turn Off	19
2.7 Power Supplies	19
2.8 Battery Voltage Monitor	19
2.9 Protection	19
2.9.1 Diode Bridge/SCR	19
2.9.2 Current Limiting function	20
2.10 Thermal Shutdown	20
2.11 External Protection Elements	20
<b>3. Manufacturing Information</b>	<b>21</b>
3.1 Mechanical Dimensions and PCB Land Patterns	21
3.1.1 CPC7695Z	21
3.1.2 CPC7695B	21
3.2 Tape and Reel Specifications	22
3.2.1 CPC7695Z	22
3.2.2 CPC7695B	22
3.3 Soldering	23
3.4 Washing	23

## 1. Specifications

### 1.1 Package Pinout

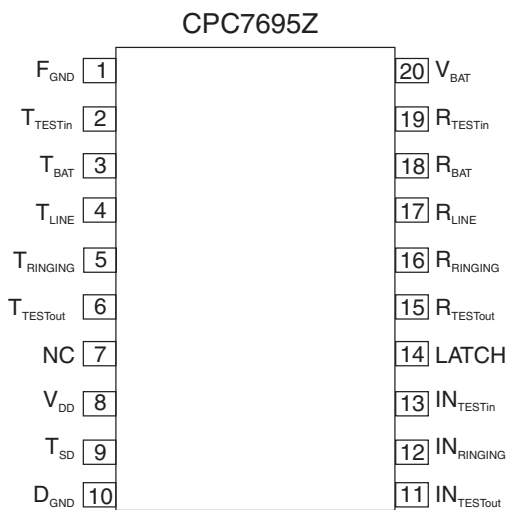
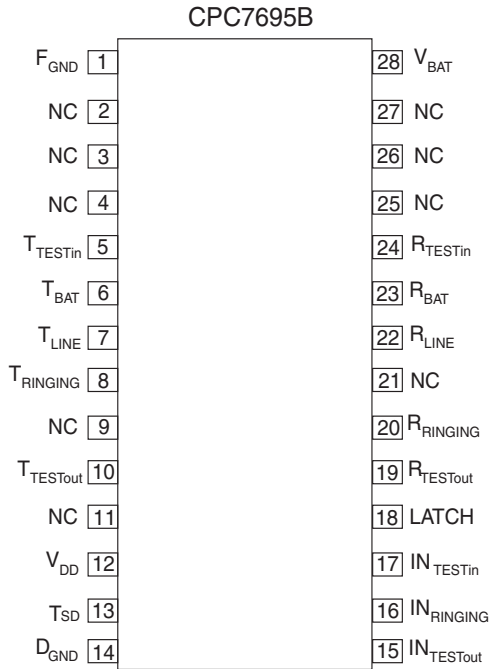

### 1.2 Pinout

20 Pin	28 Pin	Name	Description
1	1	F <sub>GND</sub>	Fault ground
	2	NC	No connection
	3	NC	No connection
	4	NC	No connection
2	5	T <sub>TESTin</sub>	Tip lead of the TESTin bus
3	6	T <sub>BAT</sub>	Tip lead of the SLIC
4	7	T <sub>LINE</sub>	Tip lead of the line side
5	8	T <sub>RINGING</sub>	Ringing generator return
	9	NC	Not connected
6	10	T <sub>TESTout</sub>	Tip lead of the TESTout bus
7	11	NC	No connection
8	12	V <sub>DD</sub>	+5 V supply
9	13	T <sub>SD</sub>	Temperature shutdown pin
10	14	D <sub>GND</sub>	Digital ground
11	15	IN <sub>TESTout</sub>	Logic control input
12	16	IN <sub>RINGING</sub>	Logic control input
13	17	IN <sub>TESTin</sub>	Logic control input
14	18	LATCH	Data latch enable control input
15	19	R <sub>TESTout</sub>	Ring lead of the TESTout bus
16	20	R <sub>RINGING</sub>	Ringing generator source
	21	NC	No connection
17	22	R <sub>LINE</sub>	Ring lead of the line side
18	23	R <sub>BAT</sub>	Ring lead of the SLIC
19	24	R <sub>TESTin</sub>	Ring lead of the TESTin bus
	25	NC	No connection
	26	NC	No connection
	27	NC	No connection
20	28	V <sub>BAT</sub>	Battery supply

### 1.3 Absolute Maximum Ratings

Parameter	Minimum	Maximum	Unit
+5 V power supply ( $V_{DD}$ )	-0.3	7	V
Battery Supply	-	-85	V
$D_{GND}$ to $F_{GND}$ separation	-5	+5	V
Logic input voltage	-0.3	$V_{DD} + 0.3$	V
Logic input to switch output isolation	-	320	V
Switch open-contact isolation (SW1, SW2, SW3, SW5, SW6, SW7, SW8, SW9, SW10)	-	320	V
Switch open-contact isolation (SW4)	-	465	V
Operating relative humidity	5	95	%
Operating temperature	-40	+110	°C
Storage temperature	-40	+150	°C

Absolute maximum electrical ratings are at 25°C

*Absolute maximum ratings are stress ratings. Stresses in excess of these ratings can cause permanent damage to the device. Functional operation of the device at conditions beyond those indicated in the operational sections of this data sheet is not implied.*

### 1.4 ESD Rating

ESD Rating (Human Body Model)
1000 V

### 1.5 General Conditions

Unless otherwise specified, minimum and maximum values are production testing requirements.

Typical values are characteristic of the device at 25°C and are the result of engineering evaluations. They are provided for informational purposes only and are not part of the manufacturing testing requirements.

Specifications cover the operating temperature range  $T_A = -40^{\circ}\text{C}$  to  $+85^{\circ}\text{C}$ . Also, unless otherwise specified all testing is performed with  $V_{DD} = +5V_{dc}$ , logic low input voltage is  $0V_{dc}$  and logic high input voltage is  $+5V_{dc}$ .

**1.6 Switch Specifications**

1.6.1 Break Switches, SW1 and SW2

Parameter	Test Conditions	Symbol	Minimum	Typical	Maximum	Unit	
Off-State Leakage Current	$V_{SW1}$ (differential) = $T_{LINE}$ to $T_{BAT}$ $V_{SW2}$ (differential) = $R_{LINE}$ to $R_{BAT}$ All-Off state.						
	+25° C, $V_{SW}$ (differential) = -320 V to gnd $V_{SW}$ (differential) = +260 V to -60 V	$I_{SW}$	-	0.1	1	$\mu A$	
	+85° C, $V_{SW}$ (differential) = -330 V to gnd $V_{SW}$ (differential) = +270 V to -60 V			0.3			
	-40° C, $V_{SW}$ (differential) = -310 V to gnd $V_{SW}$ (differential) = +250 V to -60 V			0.1			
On Resistance	$I_{SW(on)}$ = $\pm 10$ mA, $\pm 40$ mA, $R_{BAT}$ and $T_{BAT}$ = -2 V						
	+25° C	$R_{ON}$	-	14.5	-	$\Omega$	
	+85° C			20.5	28		
	-40° C			10.5	-		
On Resistance Matching	Per SW1 & SW2 On Resistance test conditions.	$\Delta R_{ON}$	-	0.15	0.55	$\Omega$	
DC current limit	$V_{SW}$ (on) = $\pm 10$ V						
	+25° C	$I_{SW}$	-	225	-	mA	
	+85° C			80			150
	-40° C			-			400
Dynamic current limit ( $t \leq 0.5 \mu s$ )	Break switches on, all other switches off. Apply $\pm 1$ kV $10 \times 1000 \mu s$ pulse with appropriate protection in place.	$I_{SW}$	-	2.5	-	A	
Logic input to switch output isolation	Logic inputs = GND						
	+25° C, $V_{SW}$ ( $T_{LINE}$ , $R_{LINE}$ ) = $\pm 320$ V	$I_{SW}$	-	0.1	1	$\mu A$	
	+85° C, $V_{SW}$ ( $T_{LINE}$ , $R_{LINE}$ ) = $\pm 330$ V			0.3			
	-40° C, $V_{SW}$ ( $T_{LINE}$ , $R_{LINE}$ ) = $\pm 310$ V			0.1			
Transient Immunity	100V <sub>pp</sub> Square Wave, 100Hz (Not production tested - limits are guaranteed by design and quality control sampling audits.)	dV/dt	1500	2100	-	V/ $\mu s$	

## 1.6.2 Ringing Return Switch, SW3

Parameter	Test Conditions	Symbol	Minimum	Typical	Maximum	Unit	
Off-State Leakage Current	$V_{SW3}$ (differential) = $T_{LINE}$ to $T_{RINGING}$ All-Off state.						
	+25° C, $V_{SW}$ (differential) = -320 V to gnd $V_{SW}$ (differential) = +260 V to -60 V	$I_{SW}$	-	0.1	1	$\mu A$	
	+85° C, $V_{SW}$ (differential) = -330 V to gnd $V_{SW}$ (differential) = +270 V to -60 V			0.3			
	-40° C, $V_{SW}$ (differential) = -310 V to gnd $V_{SW}$ (differential) = +250 V to -60 V			0.1			
On Resistance	$I_{SW(on)}$ = $\pm 0$ mA, $\pm 10$ mA						
	+25° C	$R_{ON}$	-	60	-	$\Omega$	
	+85° C			85	110		
	-40° C			45	-		
DC current limit	$V_{SW}$ (on) = $\pm 10$ V						
	+25° C	$I_{SW}$	-	120	-	mA	
	+85° C			70			85
	-40° C			-			210
Dynamic current limit ( $t \leq 0.5 \mu s$ )	Ringing switches on, all other switches off. Apply $\pm 1$ kV 10x1000 $\mu s$ pulse with appropriate protection in place.	$I_{SW}$	-	2.5	-	A	
Logic input to switch output isolation	Logic inputs = GND						
	+25° C, $V_{SW}$ ( $T_{RINGING}$ , $T_{LINE}$ ) = $\pm 320$ V	$I_{SW}$	-	0.1	1	$\mu A$	
	+85° C, $V_{SW}$ ( $T_{RINGING}$ , $T_{LINE}$ ) = $\pm 330$ V			0.3			
	-40° C, $V_{SW}$ ( $T_{RINGING}$ , $T_{LINE}$ ) = $\pm 310$ V			0.1			
Transient Immunity	100V <sub>PP</sub> Square Wave, 100Hz (Not production tested - limits are guaranteed by design and quality control sampling audits.)	dV/dt	1500	2100	-	V/ $\mu s$	

1.6.3 Ringing Switch, SW4

Parameter	Test Conditions	Symbol	Minimum	Typical	Maximum	Unit
Off-State Leakage Current	$V_{SW4}$ (differential) = $R_{LINE}$ to $R_{RINGING}$ All-Off state.					
	+25° C $V_{SW}$ (differential) = -255 V to +210 V $V_{SW}$ (differential) = +255 V to -210 V	$I_{SW}$	-	0.05	1	$\mu A$
	+85° C $V_{SW}$ (differential) = -270 V to +210 V $V_{SW}$ (differential) = +270 V to -210 V			0.1		
-40° C $V_{SW}$ (differential) = -245 V to +210 V $V_{SW}$ (differential) = +245 V to -210 V	0.05					
On Resistance	$I_{SW}$ (on) = $\pm 70$ mA, $\pm 80$ mA	$R_{ON}$	-	10	15	$\Omega$
On Voltage	$I_{SW}$ (on) = $\pm 1$ mA	$V_{ON}$	-	1.5	3	V
On-State Leakage Current	Inputs set for ringing -Measure ringing generator current to ground.	$I_{RINGING}$	-	0.1	0.25	mA
Steady-State Current*	Inputs set for ringing mode.	$I_{SW}$	-	-	150	mA
Surge Current*	Ringing switches on, all other switches off. Apply $\pm 1$ kV 10x1000 $\mu s$ pulse with appropriate protection in place.	$I_{SW}$	-	-	2	A
Release Current	SW4 transition from on to off.	$I_{RINGING}$	-	450	-	$\mu A$
	Logic inputs = GND					
Logic input to switch output isolation	+25° C, $V_{SW}$ ( $R_{RINGING}$ , $R_{LINE}$ )= $\pm 320$ V	$I_{SW}$	-	0.1	1	$\mu A$
	+85° C, $V_{SW}$ ( $R_{RINGING}$ , $R_{LINE}$ )= $\pm 330$ V			0.3		
	-40° C, $V_{SW}$ ( $R_{RINGING}$ , $R_{LINE}$ )= $\pm 310$ V			0.1		
Transient Immunity	100V <sub>PP</sub> Square Wave, 100Hz (Not production tested - limits are guaranteed by design and quality control sampling audits.)	dV/dt	1500	2100	-	V/ $\mu s$

\*Secondary protection and current limiting must prevent exceeding this parameter.

## 1.6.4 TESTout Switches, SW5 and SW6

Parameter	Test Conditions	Symbol	Minimum	Typical	Maximum	Unit
Off-State Leakage Current	$V_{SW5}$ (differential) = $T_{LINE}$ to $T_{TESTOUT}$ $V_{SW6}$ (differential) = $R_{LINE}$ to $R_{TESTOUT}$ All-Off state.					
	+25° C, $V_{SW}$ (differential) = -320 V to gnd $V_{SW}$ (differential) = +260 V to -60 V	$I_{SW}$	-	0.1	1	$\mu A$
	+85° C $V_{SW}$ (differential) = -330 V to gnd $V_{SW}$ (differential) = +260 V to -60 V			0.3		
	-40° C $V_{SW}$ (differential) = -310 V to gnd $V_{SW}$ (differential) = +250 V to -60 V			0.1		
On Resistance	$I_{SW}$ (on) = $\pm 10$ mA, $\pm 40$ mA					
	+25° C	$R_{ON}$	-	35	-	$\Omega$
	+85° C			50	70	
	-40° C			26	-	
DC current limit	$V_{SW}$ (on) = $\pm 10$ V					
	+25° C	$I_{SW}$	80	-	-	mA
	+85° C			140	-	
	-40° C			210	250	
Dynamic current limit ( $t \leq 0.5 \mu s$ )	Test out switches on, all other switches off. Apply $\pm 1$ kV, 10x1000 $\mu s$ pulse with appropriate protection in place.	$I_{SW}$	-	2.5	-	A
Logic input to switch output isolation	$V_{SW5}$ ( $T_{TESTout}$ , $T_{LINE}$ ) $V_{SW6}$ ( $R_{TESTout}$ , $R_{LINE}$ ) Logic inputs = GND					
	+25° C, $V_{SW} = \pm 320$ V	$I_{SW}$	-	0.1	1	$\mu A$
	+85° C, $V_{SW} = \pm 330$ V			0.3		
	-40° C, $V_{SW} = \pm 310$ V			0.1		
Transient Immunity	100V <sub>PP</sub> Square Wave, 100Hz (Not production tested - limits are guaranteed by design and quality control sampling audits.)	dV/dt	1500	2100	-	V/ $\mu s$



1.6.5 Ringing Test Return Switch, SW7

Parameter	Test Conditions	Symbol	Minimum	Typical	Maximum	Unit
Off-State Leakage Current	$V_{SW7}$ (differential) = $T_{TESTin}$ to $T_{RINGING}$ All-Off state.					
	+25° C, $V_{SW}$ (differential) = -320 V to gnd $V_{SW}$ (differential) = +260 to -60 V	$I_{SW}$	-	0.1	1	$\mu A$
	+85° C, $V_{SW}$ (differential) = -330 V to gnd $V_{SW}$ (differential) = +270 V to -60 V			0.3		
	-40° C, $V_{SW}$ (differential) = -310 V to gnd $V_{SW}$ (differential) = +250 V to -60 V			0.1		
On Resistance	$I_{SW}$ (on) = $\pm 10$ mA, $\pm 40$ mA					
	+25° C	$R_{ON}$	-	60	-	$\Omega$
	+85° C			85	100	
	-40° C			45	-	
DC current limit	$V_{SW}$ (on) = $\pm 10$ V					
	+25° C	$I_{SW}$	60	120	-	mA
	+85° C			80		
	-40° C			210		
Logic input to switch output isolation	Logic inputs = GND					
	+25° C, $V_{SW}(T_{RINGING}, T_{TESTin}) = \pm 320V$	$I_{SW}$	-	0.1	1	$\mu A$
	+85° C, $V_{SW}(T_{RINGING}, T_{TESTin}) = \pm 330V$			0.3		
	-40° C, $V_{SW}(T_{RINGING}, T_{TESTin}) = \pm 310V$			0.1		
Transient Immunity	100V <sub>pp</sub> Square Wave, 100Hz (Not production tested - limits are guaranteed by design and quality control sampling audits.)	dV/dt	1500	2100	-	V/ $\mu s$

## 1.6.6 Ringing Test Switch, SW8

Parameter	Test Conditions	Symbol	Minimum	Typical	Maximum	Unit
Off-State Leakage Current	$V_{SW8}$ (differential) = $R_{TESTin}$ to $R_{RINGING}$ All-Off state.					
	+25° C, $V_{SW}$ (differential) = -320 V to gnd $V_{SW}$ (differential) = +320 V to gnd	$I_{SW}$	-	0.1	1	$\mu A$
	+85° C $V_{SW}$ (differential) = -330 V to gnd $V_{SW}$ (differential) = +330 V to gnd			0.3		
	-40° C $V_{SW}$ (differential) = -310 V to gnd $V_{SW}$ (differential) = +310 V to gnd			0.1		
On Resistance	$I_{SW}$ (on) = $\pm 10$ mA, $\pm 40$ mA					
	+25° C	$R_{ON}$	-	35	-	$\Omega$
	+85° C			50	70	
	-40° C			26	-	
DC current limit	$V_{SW}$ (on) = $\pm 10$ V					
	+25° C	$I_{SW}$	-	140	-	mA
	+85° C		80	100	-	
	-40° C		-	210	250	
Dynamic current limit ( $t \leq 0.5 \mu s$ )	Ringing test switches on, all other switches off. Apply $\pm 1$ kV, $10 \times 1000 \mu s$ pulse with appropriate protection in place.	$I_{SW}$	-	2.5	-	A
Logic input to switch output isolation	$V_{SW8}$ ( $R_{RINGING}$ , $R_{TESTin}$ ) Logic inputs = GND					
	+25° C, $V_{SW} = \pm 320$ V	$I_{SW}$	-	0.1	1	$\mu A$
	+85° C, $V_{SW} = \pm 330$ V			0.3		
	-40° C, $V_{SW} = \pm 310$ V			0.1		
Transient Immunity	100V <sub>PP</sub> Square Wave, 100Hz (Not production tested - limits are guaranteed by design and quality control sampling audits.)	dV/dt	1500	2100	-	V/ $\mu s$

1.6.7 TESTin Switches, SW9 and SW10

Parameter	Test Conditions	Symbol	Minimum	Typical	Maximum	Unit
Off-state leakage current	$V_{SW9}$ (differential) = $T_{TESTin}$ to $T_{BAT}$ $V_{SW10}$ (differential) = $R_{TESTin}$ to $R_{BAT}$ All-Off state.					
	+25° C, $V_{SW}$ (differential) = -320 V to gnd $V_{SW}$ (differential) = +260 V to -60 V	$I_{SW}$	-	0.1	1	$\mu A$
	+85° C, $V_{SW}$ (differential) = -330 V to gnd $V_{SW}$ (differential) = +270 V to -60 V			0.3		
	-40° C, $V_{SW}$ (differential) = -310 V to gnd $V_{SW}$ (differential) = +250 V to -60 V			0.1		
On Resistance	$I_{SW}$ (on) = $\pm 10$ mA, $\pm 40$ mA					
	+25° C	$R_{ON}$	-	35	-	$\Omega$
	+85° C			50	70	
	-40° C			26	-	
DC current limit	$V_{SW}$ (on) = $\pm 10$ V					
	+25° C	$I_{SW}$	-	160	-	mA
	+85° C		80	110	-	
	-40° C		-	210	250	
Logic input to switch output isolation	Logic inputs = GND					
	+25° C, $V_{SW}(T_{TESTin}, R_{TESTin}) = \pm 320$ V	$I_{SW}$	-	0.1	1	$\mu A$
	+85° C, $V_{SW}(T_{TESTin}, R_{TESTin}) = \pm 330$ V			0.3		
	-40° C, $V_{SW}(T_{TESTin}, R_{TESTin}) = \pm 310$ V			0.1		
Transient Immunity	100V <sub>pp</sub> Square Wave, 100Hz (Not production tested - limits are guaranteed by design and quality control sampling audits.)	dV/dt	1500	2100	-	V/ $\mu s$

### 1.7 Digital I/O Electrical Specifications

Parameter	Test Conditions	Symbol	Minimum	Typical	Maximum	Unit
<b>Input Characteristics</b>						
Input voltage, Logic low	Input voltage falling	$V_{IL}$	0.8	1.1	-	V
Input voltage, Logic high	Input voltage rising	$V_{IH}$	-	1.7	2.0	
Input leakage current, $I_{N_{RINGING}}$ , $I_{N_{TESTin}}$ , and $I_{N_{TESTout}}$ Logic high	$V_{DD} = 5.5\text{ V}$ , $V_{BAT} = -75\text{ V}$ , $V_{IH} = 2.4\text{ V}$	$I_{IH}$	-	0.1	1	$\mu\text{A}$
Input leakage current, $I_{N_{RINGING}}$ , $I_{N_{TESTin}}$ , and $I_{N_{TESTout}}$ Logic low	$V_{DD} = 5.5\text{ V}$ , $V_{BAT} = -75\text{ V}$ , $V_{IL} = 0.4\text{ V}$	$I_{IL}$	-	0.1	1	$\mu\text{A}$
Input leakage current, LATCH Logic high	$V_{DD} = 4.5\text{ V}$ , $V_{BAT} = -75\text{ V}$ , $V_{IH} = 2.4\text{ V}$	$I_{IH}$	10	19	-	$\mu\text{A}$
Input leakage current, LATCH Logic low	$V_{DD} = 5.5\text{ V}$ , $V_{BAT} = -75\text{ V}$ , $V_{IL} = 0.4\text{ V}$	$I_{IL}$	-	47	125	$\mu\text{A}$
Input leakage current, $T_{SD}$ Logic high	$V_{DD} = 5.5\text{ V}$ , $V_{BAT} = -75\text{ V}$ , $V_{IH} = V_{DD}$	$I_{IH}$	10	16	30	$\mu\text{A}$
Input leakage current, $T_{SD}$ Logic low	$V_{DD} = 5.5\text{ V}$ , $V_{BAT} = -75\text{ V}$ , $V_{IL} = 0.4\text{ V}$	$I_{IL}$	10	16	30	$\mu\text{A}$
<b>Output Characteristics</b>						
Output voltage, $T_{SD}$ Logic high	$V_{DD} = 5.5\text{ V}$ , $V_{BAT} = -75\text{ V}$ , $I_{TSD} = 10\mu\text{A}$	$V_{TSD\_off}$	2.4	$V_{DD}$	-	V
Output voltage, $T_{SD}$ Logic low	$V_{DD} = 5.5\text{ V}$ , $V_{BAT} = -75\text{ V}$ , $I_{TSD} = 1\text{ mA}$	$V_{TSD\_on}$	-	0	0.4	V

### 1.8 Voltage and Power Specifications

Parameter	Test Conditions	Symbol	Minimum	Typical	Maximum	Unit
<b>Voltage Requirements</b>						
$V_{DD}$	-	$V_{DD}$	4.5	5.0	5.5	V
$V_{BAT}^1$	-	$V_{BAT}$	-19	-48	-72	V
<sup>1</sup> $V_{BAT}$ is used only for internal protection circuitry. If $V_{BAT}$ rises above -10 V, the device will enter the all-off state and will remain in the all-off state until the battery drops below -15 V						
<b>Power Specifications</b>						
Power consumption	$V_{DD} = 5\text{ V}$ , $V_{BAT} = -48\text{ V}$ , $V_{IH} = 2.4\text{ V}$ , $V_{IL} = 0.4\text{ V}$ , Measure $I_{DD}$ and $I_{BAT}$ .					
	Talk and All-Off States	P	-	4.7	10.5	mW
	All other states	P	-	5.2	10.5	mW
$V_{DD}$ current in talk and all-off states	$V_{DD} = 5\text{ V}$ , $V_{BAT} = -48\text{ V}$ , $V_{IH} = 2.4\text{ V}$ , $V_{IL} = 0.4\text{ V}$	$I_{DD}$	-	0.9	2.0	mA
$V_{DD}$ current in all other states		$I_{DD}$	-	1.0	2.0	
$V_{BAT}$ current in any state	$V_{DD} = 5\text{ V}$ , $V_{BAT} = -48\text{ V}$ , $V_{IH} = 2.4\text{ V}$ , $V_{IL} = 0.4\text{ V}$	$I_{BAT}$	-	4	10	$\mu\text{A}$

### 1.9 Protection Circuitry Electrical Specifications

Parameter	Conditions	Symbol	Minimum	Typical	Maximum	Unit
<b>Protection Diode Bridge</b>						
Forward Voltage drop, continuous current (50/60 Hz)	Apply $\pm$ dc current limit of break switches	$V_F$	-	2.8	3.5	V
Forward Voltage drop, surge current	Apply $\pm$ dynamic current limit of break switches	$V_F$	-	5	-	
<b>Protection SCR (CPC7695xA and CPC7695xC)</b>						
Surge current	-	-	-	-	*	A
Trigger current:	SCR activates, +25° C	$I_{TRIG}$	-	150	-	mA
Current into $V_{BAT}$ pin.	SCR activates, +85° C			80		
Hold current: Current through protection SCR	SCR remains active, +25° C	$I_{HOLD}$	110	220	-	mA
	SCR remains active, +85° C			145		
Gate trigger voltage	$I_{GATE} = I_{TRIGGER}^{\S}$	$V_{TBAT}$ or $V_{RBAT}$	$V_{BAT} - 4$	-	$V_{BAT} - 2$	V
Reverse leakage current	$V_{BAT} = -48\text{ V}$	$I_{VBAT}$	-	-	1.0	$\mu\text{A}$
On-state voltage	0.5 A, $t = 0.5\ \mu\text{s}$	$V_{TBAT}$ or $V_{RBAT}$	-	-3	-	V
	2.0 A, $t = 0.5\ \mu\text{s}$			-5		
<b>Temperature Shutdown Specifications</b>						
Shutdown activation temperature	Not production tested - limits are guaranteed by design and Quality Control sampling audits.	$T_{TSD\_on}$	110	125	150	°C
Shutdown circuit hysteresis		$T_{TSD\_off}$	10	-	25	°C
*Passes GR1089 and ITU-T K.20 with appropriate secondary protection in place.						
<sup>\S</sup> $V_{BAT}$ must be capable of sourcing $I_{TRIGGER}$ for the internal SCR to activate.						

1.10 Truth Tables

1.10.1 Truth Table for CPC7695xA and CPC7695xB

State	INRINGING	INTESTin	INTESTout	Latch	TSD	TESTin Switches	Break Switches	Ringing Test Switches	Ringing Switches	TESTout Switches	
Talk	0	0	0	0	Z <sup>1</sup>	Off	On	Off	Off	Off	
TESTout	0	0	1			Off	Off	Off	Off	Off	On
TESTin	0	1	0			On	Off	Off	Off	Off	Off
Simultaneous TESTin and TESTout	0	1	1			On	Off	Off	Off	Off	On
Ringing	1	0	0			Off	Off	Off	Off	On	Off
Ringing Generator Test	1	1	0			Off	Off	On	Off	Off	Off
Latched	X	X	X			1	Unchanged	Unchanged	Unchanged	Unchanged	Unchanged
All-Off	1	0	1	0	0	Off	Off	Off	Off	Off	
	1	1	1	0		Off	Off	Off	Off	Off	
	X	X	X	X		Off	Off	Off	Off	Off	

<sup>1</sup> Z = High Impedance. Because TSD has an internal pull up at this pin, it should be controlled with an open-collector or open-drain type device.

1.10.2 Truth Table for CPC7695xC

State	INRINGING	INTESTin	INTESTout	Latch	TSD	TESTin Switches	Break Switches	Ringing Test Switches	Ringing Switches	TESTout Switches	
Talk	0	0	0	0	Z <sup>1</sup>	Off	On	Off	Off	Off	
TESTout	0	0	1			Off	Off	Off	Off	Off	On
TESTin	0	1	0			On	Off	Off	Off	Off	Off
Simultaneous TESTin and TESTout	0	1	1			On	Off	Off	Off	Off	On
Ringing	1	0	0			Off	Off	Off	Off	On	Off
Ringing Generator Test	1	1	0			Off	Off	On	Off	Off	Off
Simultaneous TESTout and Ringing Generator Test	1	1	1			Off	Off	On	Off	Off	On
Latched	X	X	X	1	Unchanged	Unchanged	Unchanged	Unchanged	Unchanged	Unchanged	
All-Off	1	0	1	0	0	Off	Off	Off	Off	Off	
	X	X	X	X		Off	Off	Off	Off	Off	

<sup>1</sup> Z = High Impedance. Because TSD has an internal pull up at this pin, it should be controlled with an open-collector or open-drain type device.

## 2. Functional Description

### 2.1 Introduction

The CPC7695 has the following states:

- **Talk.** Loop break switches SW1 and SW2 closed, all other switches open.
- **Ringin**g. Ringing switches SW3 and SW4 closed, all other switches open.
- **TESTout.** Testout switches SW5 and SW6 closed, all other switches open.
- **Ringin**g generator test. SW7 and SW8 closed, all other switches open.
- **TESTin.** Testin switches SW9 and SW10 closed, all other switches open.
- **Simultaneous TESTin and TESTout.** SW9, SW10, SW5, and SW6 closed, all other switches open.
- **Simultaneous TESTout and Ringin**g generator test. SW5, SW6, SW7, and SW8 closed, all other switches open (only on the xC and xD versions).
- **All-Off.** All switches open.

See “[Truth Tables](#)” on page 14 for more information.

The CPC7695 offers break-before-make and make-before-break switching from the ringing state to the talk state with simple TTL level logic input control. Solid-state switch construction means no impulse noise is generated when switching during ringing cadence or ring trip, eliminating the need for external zero-cross switching circuitry. State-control is via TTL logic-level input so no additional driver circuitry is required. The linear line break switches SW1 and SW2 have exceptionally low  $R_{ON}$  and excellent matching characteristics. The ringing switch, SW4, has a minimum open contact breakdown voltage of 465 V at +25°C, sufficiently high with proper protection to prevent breakdown in the presence of a transient fault condition (i.e., passing the transient on to the ringing generator).

Integrated into the CPC7695 is an over-voltage clamping circuit, active current limiting, and a thermal shutdown mechanism to provide protection to the SLIC during a fault condition. Positive and negative lightning surge currents are reduced by the current limiting circuitry and hazardous potentials are diverted away from the SLIC via the protection diode bridge or the optional integrated protection SCR. Power-cross potentials are also reduced by the current limiting and thermal shutdown circuits.

To protect the CPC7695 from an overvoltage fault condition, the use of a secondary protector is required. The secondary protector must limit the voltage seen at the  $T_{LINE}$  and  $R_{LINE}$  terminals to a level below the maximum breakdown voltage of the switches. To minimize the stress on the solid-state contacts, use of a foldback or crowbar type secondary protector is highly recommended. With proper selection of the secondary protector, a line card using the CPC7695 will meet all relevant ITU, LSSGR, TIA/EIA and IEC protection requirements.

The CPC7695 operates from a single +5 V supply only. This gives the device extremely low idle and active power consumption with virtually any range of battery voltage. The battery voltage used by the CPC7695 has a two fold function. For protection purposes it is used as a fault condition current source for the internal integrated protection circuitry. Secondly, it is used as a reference so that in the event of battery voltage loss, the CPC7695 will enter the all-off state.

### 2.2 Under Voltage Switch Lock Out Circuitry

#### 2.2.1 Introduction

Smart logic in the CPC7695 now provides for switch state control during both power up and power loss transitions. An internal detector is used to evaluate the  $V_{DD}$  supply to determine when to de-assert the under voltage switch lock out circuitry with a rising  $V_{DD}$  and when to assert the under voltage switch lock out circuitry with a falling  $V_{DD}$ . Any time unsatisfactory low  $V_{DD}$  conditions exist, the lock out circuit overrides user switch control by blocking the information at the external input pins and conditioning internal switch commands to the all-off state. Upon restoration of  $V_{DD}$ , the switches will remain in the all-off state until the LATCH input is pulled low.

The rising  $V_{DD}$  switch lock-out release threshold is internally set to ensure all internal logic is properly biased and functional before accepting external switch commands from the inputs to control the switch states. For a falling  $V_{DD}$  event, the lock-out threshold is set to assure proper logic and switch behavior up to the moment the switches are forced off and external inputs are suppressed.

To facilitate hot plug insertion and system power up state control, the LATCH pin has an integrated weak pull up resistor to the  $V_{DD}$  power rail that will hold a non-driven LATCH pin at a logic high state. This enables board designers to use the CPC7695 with FPGAs and other devices that provide high impedance outputs during power up and logic configuration. The weak pull up allows a fan out of up to 32 when the system's LATCH control driver has a logic low minimum sink capability of 4mA.

### 2.2.2 Hot Plug and Power Up Circuit Design Considerations

There are six possible start up scenarios that can occur during power up. They are:

1. All inputs defined at power up & LATCH = 0
2. All inputs defined at power up & LATCH = 1
3. All inputs defined at power up & LATCH = Z
4. All inputs not defined at power up & LATCH = 0
5. All inputs not defined at power up & LATCH = 1
6. All inputs not defined at power up & LATCH = Z

Under all of the start up situations listed above the CPC7695 will hold all of its switches in the all-off state during power up. When  $V_{DD}$  requirements have been satisfied the LCAS will complete its start up procedure in one of three conditions.

For start up scenario 1 the CPC7695 will transition from the all-off state to the state defined by the inputs when  $V_{DD}$  is valid.

For start up scenarios 2, 3, 5, and 6 the CPC7695 will power up in the all-off state and remain there until the LATCH pin is pulled low. This allows for an indefinite all-off state for boards inserted into a powered system but are not configured for service or boards that need to wait for other devices to be configured first.

Start up scenario 4 will start up with all switches in the all-off state but upon the acceptance of a valid  $V_{DD}$  the LCAS will revert to any one of the legitimate states listed in the truth tables and there after may randomly change states based on input pin leakage currents and loading. Because the LCAS state after power up can not be predicted with this start up condition it should never be utilized.

On designs that do not wish to individually control the LATCH pins of multi-port cards it is possible to bus many (or all) of the LATCH pins together to create a single board level input enable control.

## 2.3 Switch Logic

### 2.3.1 Start-up

The CPC7695 uses smart logic to monitor the  $V_{DD}$  supply. Any time the  $V_{DD}$  is below an internally set threshold, the smart logic places the control logic to the all-off state. An internal pullup on the LATCH pin locks the CPC7695 in the all-off state following start-up until the LATCH pin is pulled down to a logic low. Prior to the assertion of a logic low at the LATCH pin, the switch control inputs must be properly conditioned.

### 2.3.2 Switch Timing

The CPC7695 provides, when switching from the ringing state to the talk state, the ability to control the release timing of the ringing switches SW3 and SW4 relative to the state of the break switches SW1 and SW2 using simple TTL logic-level inputs. The two available techniques are referred to as make-before-break and break-before-make operation. When the switch contacts of SW1 and SW2 are closed (made) before the ringing switch contacts of SW3 and SW4 are opened (broken), this is referred to as make-before-break operation. Break-before-make operation occurs when the ringing contacts of SW3 and SW4 are opened (broken) before the switch contacts of SW1 and SW2 are closed (made). With the CPC7695, make-before-break and break-before-make operations can easily be accomplished by applying the proper sequence of logic-level inputs to the device.

The logic sequences for either mode of operation are given in [“Make-Before-Break Operation Logic Table \(Ringing to Talk Transition\)” on page 17](#), [“Break-Before-Make Operation Logic Table \(Ringing to Talk Transition\)” on page 17](#) and [“Alternate Break-Before-Make Operation Logic Table \(Ringing to Talk Transition\)” on page 18](#). Logic states and explanations are shown in [“Truth Tables” on page 14](#).

### 2.3.3 Make-Before-Break Operation

To use make-before-break operation, change the logic inputs from the ringing state directly to the talk state. Application of the talk state opens the ringing return switch, SW3, as the break switches SW1 and SW2 close. The ringing switch, SW4, remains closed until the next zero-crossing of the ringing current. While in the make-before-break state, ringing potentials in excess of the CPC7695 protection circuitry thresholds will be diverted away from the SLIC.



Make-Before-Break Operation Logic Table (Ringing to Talk Transition)

State	IN <sub>RINGING</sub>	IN <sub>TESTin</sub>	IN <sub>TESTout</sub>	Latch	T <sub>SD</sub>	Timing	Break Switches	Ringing Return Switch (SW3)	Ringing Switch (SW4)	Test Switches
Ringing	1	0	0	0	Z	-	Off	On	On	Off
Make-Before-Break	0	0	0			SW4 waiting for next zero-current crossing to turn off. Maximum time is one-half of the ringing cycle. In this transition state, current that is limited to the break switch dc current limit value will be sourced from the ring node of the SLIC.	On	Off	On	Off
Talk	0	0	0			Zero-cross current has occurred	On	Off	Off	Off

2.3.4 Break-Before-Make Operation

Break-before-make operation of the CPC7695 can be achieved using two different techniques.

The first method uses manipulation of the (IN<sub>RINGING</sub>, IN<sub>TESTin</sub>, IN<sub>TESTout</sub>) logic inputs as shown in “**Break-Before-Make Operation Logic Table (Ringing to Talk Transition)**” on page 17.

1. At the end of the ringing state apply the all-off state (1,0,1). This releases the ringing return switch (SW3) while the ringing switch remains on waiting for the next zero current event.

2. Hold the all-off state for at least one-half of a ringing cycle to assure that a zero crossing event occurs and that the ringing switch (SW4) has opened.
3. Apply inputs for the next desired state. For the talk state, the inputs would be (0,0,0).

Break-before-make operation occurs when the ringing switch opens before the break switches SW1 and SW2 close.

Break-Before-Make Operation Logic Table (Ringing to Talk Transition)

State	IN <sub>RINGING</sub>	IN <sub>TESTin</sub>	IN <sub>TESTout</sub>	Latch	T <sub>SD</sub>	Timing	Break Switches	Ringing Return Switch (SW3)	Ringing Switch (SW4)	Test Switches
Ringing	1	0	0	0	Z	-	Off	On	On	Off
All-off *	1	0	1			Hold this state for at least one-half of ringing cycle. SW4 waiting for zero current to turn off.	Off	Off	On	Off
Break-Before-Make *	1	0	1			Zero current has occurred. SW4 has opened	Off	Off	Off	Off
Talk	0	0	0			Break switches close.	On	Off	Off	Off

\* For the CPC7695xA/B versions the input pattern (1,1,1) may also be used for the all-off state.

2.3.5 Alternate Break-Before-Make Operation

The second break-before-make method is also available for use with all versions of the CPC7695. As

shown in “**Truth Table for CPC7695xA and CPC7695xB**” on page 14 and “**Truth Table for CPC7695xC**” on page 14, the bidirectional T<sub>SD</sub> interface disables all of the CPC7695

switches when pulled to a logic low. Although logically disabled, an active (closed) ringing switch (SW4) will remain closed until the next current zero crossing event.

As shown in the table “**Break-Before-Make Operation Logic Table (Ringing to Talk Transition)**” on page 17, this operation is similar to the one shown in “**Alternate Break-Before-Make Operation Logic Table (Ringing to Talk Transition)**” on page 18, except in the method used to select the all-off state and when the  $IN_{RINGING}$ ,  $IN_{TESTin}$  and  $IN_{TESTout}$  inputs are reconfigured for the talk state.

1. Pull  $T_{SD}$  to a logic low to end the ringing state. This opens the ringing return switch (SW3) and

- prevents any other switches from closing.
2. Keep  $T_{SD}$  low for at least one-half the duration of the ringing cycle period to allow sufficient time for a zero crossing current event to occur and for the circuit to enter the break before make state.
3. During the  $T_{SD}$  low period, set the  $IN_{RINGING}$ ,  $IN_{TESTin}$  and  $IN_{TESTout}$  inputs to the talk state (0,0,0).
4. Release  $T_{SD}$  allowing the internal pull-up to activate the break switches.

When using  $T_{SD}$  as an input, the two recommended states are “0” which over rides logic input pins and forces an all-off state and “Z” which allows switch control via the logic input pins. This requires the use of an open-collector or open-drain type buffer.

Alternate Break-Before-Make Operation Logic Table (Ringing to Talk Transition)

State	$IN_{RINGING}$	$IN_{TESTin}$	$IN_{TESTout}$	Latch	$T_{SD}$	Timing	Break Switches	Ringing Return Switch (SW3)	Ringing Switch (SW4)	Test Switches
Ringing	1	0	0	0	Z	-	Off	On	On	Off
All-off	1	0	1	X	0	Hold this state for at least one-half of ringing cycle. SW4 waiting for zero current to turn off.	Off	Off	On	Off
Break-Before-Make	0	0	0			Zero current has occurred. SW4 has opened	Off	Off	Off	Off
Talk	0	0	0	0	Z	Break switches close.	On	Off	Off	Off

\* For the CPC7695xA/B versions the input pattern (1,1,1) may also be used for the all-off state.

### 2.4 Data Latch

The CPC7695 has an integrated transparent data latch. The latch enable operation is controlled by TTL logic input levels at the LATCH pin. Data input to the latch are via the input pins, while the output of the data latch are internal nodes used for state control. When the LATCH enable control pin is at logic 0 the data latch is transparent and the input data control signals flow directly through the latch to the state control circuitry. A change in input will be reflected by a change in switch state. Whenever the LATCH enable control pin is at logic 1, the latch is active and data is locked. Subsequent input changes will not result in a change to the control logic or affect the existing switch state.

Switches will remain in the state they were in when the LATCH pin changes from logic 0 to logic 1 and will not respond to changes in input as long as the latch is at logic 1. However, neither the  $T_{SD}$  input nor the  $T_{SD}$  output control functions are affected by the latch function. Internal thermal shutdown control and external “All-off” control via  $T_{SD}$  is not affected by the state of the LATCH enable input.

### 2.5 $T_{SD}$ Pin Description

The  $T_{SD}$  pin is a bi-directional I/O structure with an internal pull up sourced from  $V_{DD}$ . As an output, this pin indicates the status of the thermal shutdown circuitry. Typically, during normal operation, this pin will be pulled up to  $V_{DD}$  but under fault conditions that create excess thermal loading the CPC7695 will enter thermal shutdown and a logic low will be output.

As an input, the  $T_{SD}$  pin can be utilized to place the CPC7695 into the “All-Off” state by simply pulling the input low via an open-collector type buffer. Using a standard output with an active logic high drive capability will sink the pull-up current resulting in unnecessary power consumption.

Use of a standard output buffer with an active high drive capability will not disable the thermal shutdown mechanism. The ability to enter thermal shutdown during a fault condition is independent of the connection at the  $T_{SD}$  input.

The CPC7695’s internal pull up has a nominal value of  $16\mu A$ .

### 2.6 Ringing Switch Zero-Cross Current Turn Off

After the application of a logic input to turn SW4 off, the ringing switch is designed to delay the change in state until the next zero-crossing. Once on, the switch requires a zero-current cross to turn off, and therefore should not be used to switch a pure DC signal. The switch will remain in the on state no matter the logic input until the next zero crossing. These switching characteristics will reduce and possibly eliminate overall system impulse noise normally associated with ringing switches. See Clare application note [AN-144, Impulse Noise Benefits of Line Card Access Switches](#) for more information. The attributes of ringing switch SW4 may make it possible to eliminate the need for a zero-cross switching scheme. A minimum impedance of  $300\ \Omega$  in series with the ringing generator is recommended.

### 2.7 Power Supplies

Both a +5 V supply and battery voltage are connected to the CPC7695. Switch state control is powered exclusively by the +5 V supply. As a result, the CPC7695 exhibits extremely low power consumption during active and idle states.

Although battery power is not used for switch control, it is required to supply trigger current for the integrated internal protection circuitry SCR during fault conditions. This integrated SCR is designed to activate whenever the voltage at  $T_{BAT}$  or  $R_{BAT}$  drops 2 to 4 V below the applied voltage on the  $V_{BAT}$  pin. Because the battery supply at this pin is required to source trigger current during negative overvoltage fault conditions at tip and ring, it is important that the

net supplying this current be a low impedance path for high speed transients such as lightning. This will permit trigger currents to flow enabling the SCR to activate and thereby prevent a fault induced negative overvoltage event at the  $T_{BAT}$  or  $R_{BAT}$  nodes.

### 2.8 Battery Voltage Monitor

The CPC7695 also uses the  $V_{BAT}$  pin to monitor battery voltage. If the system battery voltage is lost, the CPC7695 immediately enters the all-off state. It remains in this state until the system battery voltage is restored. The device also enters the all-off state if the battery voltage rises more positive than about  $-10\ V$  and remains in the all-off state until the battery voltage drops below  $-15\ V$ . This battery monitor feature draws a small current from the battery (less than  $1\ \mu A$  typical) and will add slightly to the device’s overall power dissipation.

This monitor function performs properly if the CPC7695 and SLIC share a common battery supply origin. Otherwise, if battery is lost to the CPC7695 but not to the SLIC, the  $V_{BAT}$  pin will be internally biased by the potential applied to the  $T_{BAT}$  or  $R_{BAT}$  pins via the internal protection circuitry SCR trigger current path.

### 2.9 Protection

#### 2.9.1 Diode Bridge/SCR

The CPC7695 uses a combination of current limited break switches, a diode bridge/SCR clamping circuit, and a thermal shutdown mechanism to protect the SLIC device or other associated circuitry from damage during line transient events such as lightning. During a positive transient condition, the fault current is conducted through the diode bridge to ground via  $F_{GND}$ . Voltage is clamped to a diode drop above ground. During a negative transient of 2 to 4 V more negative than the voltage source at  $V_{BAT}$ , the SCR conducts and faults are shunted to  $F_{GND}$  via the SCR or the diode bridge.

In order for the SCR to crowbar or foldback, the SCR’s on-voltage (see “[Protection Circuitry Electrical Specifications](#)” on page 13) must be less than the applied voltage at the  $V_{BAT}$  pin. If the  $V_{BAT}$  voltage is less negative than the SCR on-voltage, or if the  $V_{BAT}$  supply is unable to source the trigger current, the SCR will not crowbar.

For power induction or power-cross fault conditions, the positive cycle of the transient is clamped to a diode drop above ground and the fault current is directed to ground. The negative cycle of the transient will cause the SCR to conduct when the voltage exceeds the  $V_{BAT}$  reference voltage by two to four volts, steering the fault current to ground.

Note: The CPC7695xB does not contain a protection SCR but instead utilizes a diode bridge to clamp both polarities of a fault transient. These diodes pass the charge of negative fault potentials to the  $V_{BAT}$  pin.

### 2.9.2 Current Limiting function

If a lightning strike transient occurs when the device is in the talk state, the current is passed along the line to the integrated protection circuitry and restricted by the dynamic current limit response of the active switches. During the talk state when a 1000V 10x1000  $\mu$ S pulse (GR-1089-CORE lightning) is applied to the line though a properly clamped external protector, the current seen at  $T_{LINE}$  or  $R_{LINE}$  will be a pulse with a typical magnitude of 2.5 A and a duration of less than 0.5  $\mu$ s.

If a power-cross fault occurs with the device in the talk state, the current is passed through the break switches SW1 and SW2 on to the integrated protection circuit but is limited by the dynamic DC current limit response of the two break switches. The DC current limit specified over temperature is between 80 mA and 425 mA, and the circuitry has a negative temperature coefficient. As a result, if the device is subjected to extended heating due to a power cross fault condition, the measured current into  $T_{LINE}$  or  $R_{LINE}$  will decrease as the device temperature increases. If the device temperature rises sufficiently, the temperature shutdown mechanism will activate and the device will enter the all-off state.

### 2.10 Thermal Shutdown

The thermal shutdown mechanism will activate when the device die temperature reaches a minimum of 110° C, placing the device in the all-off state regardless of  $IN_{RINGING}$ ,  $IN_{TESTin}$  and  $IN_{TESTout}$  logic inputs. During thermal shutdown events the  $T_{SD}$  pin will output a logic low with a nominal 0 V level. A logic high is output from the  $T_{SD}$  pin during normal operation with a typical output level equal to  $V_{DD}$ .

If presented with a short duration transient such as a lightning event, the thermal shutdown feature will typically not activate. But in an extended power-cross event, the device temperature will rise and the thermal shutdown mechanism will activate forcing the switches to the all-off state. At this point the current measured into  $T_{LINE}$  or  $R_{LINE}$  will drop to zero. Once the device enters thermal shutdown it will remain in the all-off state until the temperature of the die drops below the deactivation level of the thermal shutdown circuit. This permits the device to return to normal operation. If the transient has not passed, current will again flow up to the value allowed by the dynamic DC current limiting of the switches and heating will resume, reactivating the thermal shutdown mechanism. This cycle of entering and exiting the thermal shutdown mode will continue as long as the fault condition persists. If the magnitude of the fault condition is great enough, the external secondary protector will activate shunting the fault current to ground.

### 2.11 External Protection Elements

The CPC7695 requires only over voltage secondary protection on the loop side of the device. The integrated protection feature described above negates the need for additional external protection on the SLIC side. The secondary protector must limit voltage transients to levels that do not exceed the breakdown voltage or input-output isolation barrier of the CPC7695. A foldback or crowbar type protector is recommended to minimize stresses on the CPC7695.

Consult Clare's application note, AN-100, "[Designing Surge and Power Fault Protection Circuits for Solid State Subscriber Line Interfaces](#)" for equations related to the specifications of external secondary protectors, fused resistors and PTCs.

### 3. Manufacturing Information

#### 3.1 Mechanical Dimensions and PCB Land Patterns

##### 3.1.1 CPC7695Z

##### 20-Lead SOIC Package

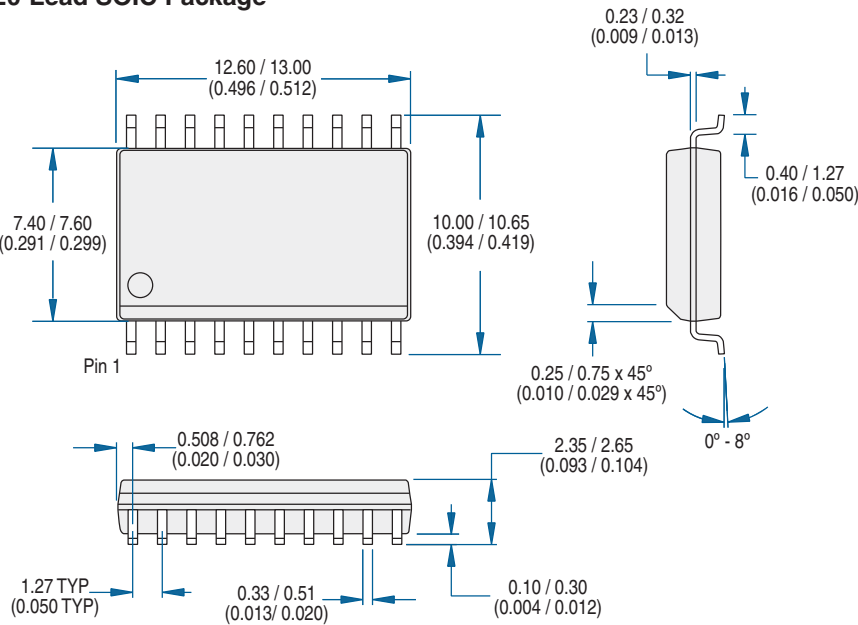

##### Recommended PCB Land Pattern

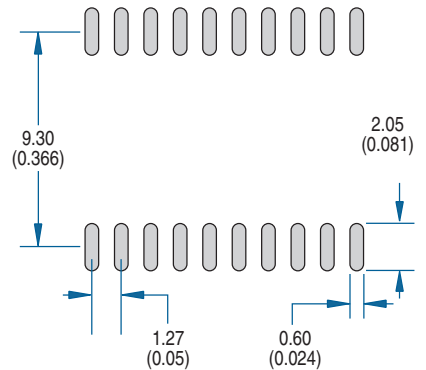

Dimensions  
mm MIN / mm MAX  
(inches MIN / inches MAX)

##### 3.1.2 CPC7695B

##### 28-Lead SOIC Package

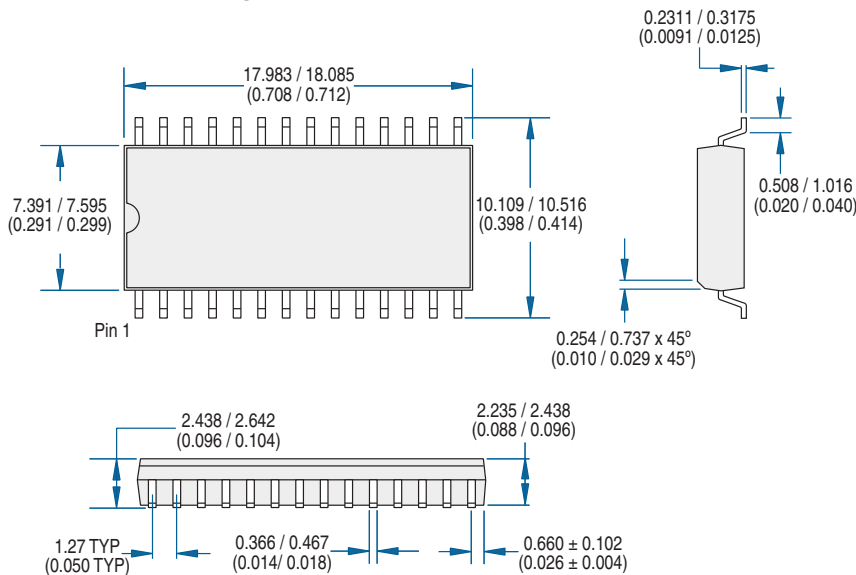

##### Recommended PCB Land Pattern

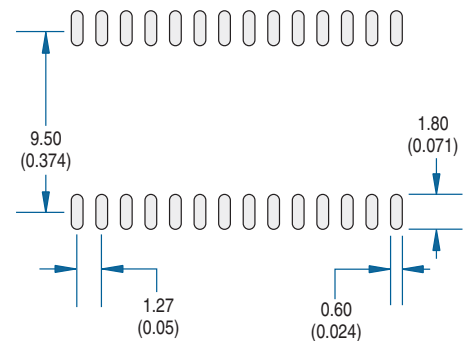

Dimensions  
mm MIN / mm MAX  
(inches MIN / inches MAX)

3.2 Tape and Reel Specifications

3.2.1 CPC7695Z

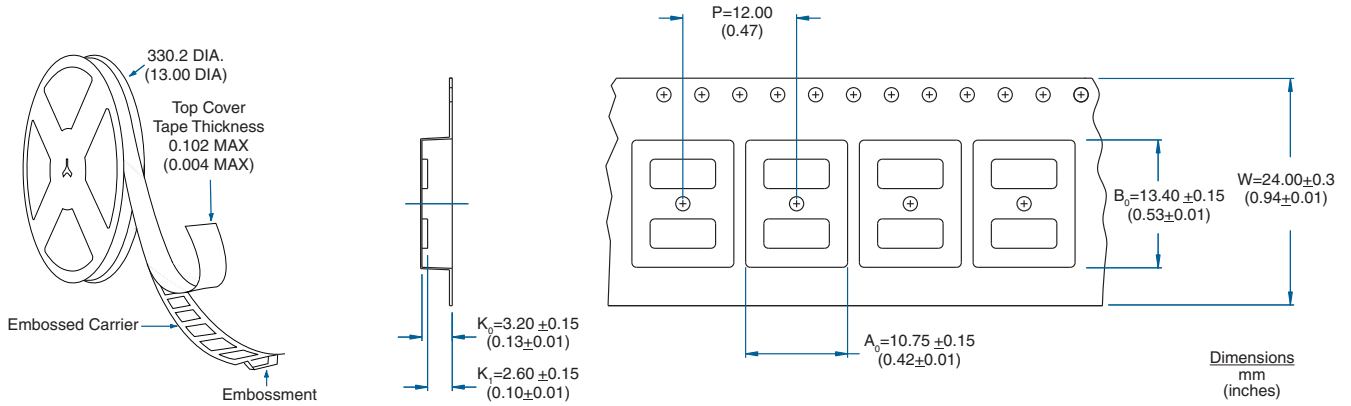

3.2.2 CPC7695B

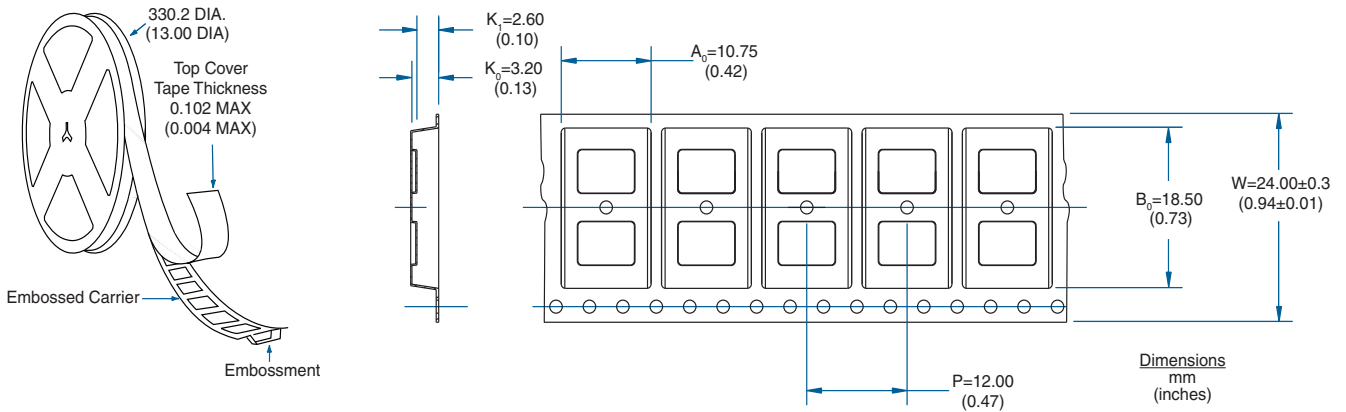

### 3.3 Soldering

For proper assembly, the component must be processed in accordance with the current revision of IPC/JEDEC standard, J-STD-020. Failure to follow the recommended guidelines may cause permanent damage to the device resulting in impaired performance and/or a reduced lifetime expectancy.

### 3.4 Washing

Clare does not recommend ultrasonic cleaning of this part.



For additional information please visit [www.clare.com](http://www.clare.com)

*Clare, Inc. makes no representations or warranties with respect to the accuracy or completeness of the contents of this publication and reserves the right to make changes to specifications and product descriptions at any time without notice. Neither circuit patent licenses or indemnity are expressed or implied. Except as set forth in Clare's Standard Terms and Conditions of Sale, Clare, Inc. assumes no liability whatsoever, and disclaims any express or implied warranty relating to its products, including, but not limited to, the implied warranty of merchantability, fitness for a particular purpose, or infringement of any intellectual property right.*

*The products described in this document are not designed, intended, authorized, or warranted for use as components in systems intended for surgical implant into the body, or in other applications intended to support or sustain life, or where malfunction of Clare's product may result in direct physical harm, injury, or death to a person or severe property or environmental damage. Clare, Inc. reserves the right to discontinue or make changes to its products at any time without notice.*

Specification: DS-CPC7695-R00D  
© Copyright 2009, Clare, Inc.  
All rights reserved. Printed in USA.  
10/14/09