

# Low Voltage ORing FET Controller

## ISL6146

The ISL6146 represents a family of ORing MOSFET controllers capable of ORing voltages from 1V to 18V. Together with suitably sized N-channel power MOSFETs, the ISL6146 increases power distribution efficiency when replacing a power ORing diode in high current applications. It provides gate drive voltage for the MOSFET(s) with a fully integrated charge pump.

The ISL6146 allows users to adjust with external resistor(s) the  $V_{OUT} - V_{IN}$  trip point, which adjusts the control sensitivity to system power supply noise. An open drain FAULT pin will indicate if a conditional or FET fault has occurred.

The ISL6146A and ISL6146B are optimized for very low voltage operation, down to 1V with an additional independent bias of 3V or greater.

The ISL6146C provides a voltage compliant mode of operation down to 3V with programmable Undervoltage Lock Out and Overvoltage Protection threshold levels

The ISL6146D and ISL6146E are like the ISL6146A and ISL6146B respectively but do not have conduction state reporting via the fault output.

TABLE 1. KEY DIFFERENCES BETWEEN PARTS IN FAMILY

PART NUMBER	KEY DIFFERENCES
ISL6146A	Separate BIAS and VIN with Active High Enable
ISL6146B	Separate BIAS and VIN with Active Low Enable
ISL6146C	VIN with OVP/UVLO Inputs
ISL6146D	ISL6146A wo Conduction Monitor & Reporting
ISL6146E	ISL6146B wo Conduction Monitor & Reporting

## Features

- ORing Down to 1V and Up to 20V with ISL6146A, ISL6146B, ISL6146D and ISL6146E
- Programmable Voltage Compliant Operation with ISL6146C
- VIN Hot Swap Transient Protection Rating to +24V
- High Speed Comparator Provides Fast  $<0.3\mu s$  Turn-off in Response to Shorts on Sourcing Supply
- Fastest Reverse Current Fault Isolation with 6A Turn-off Current
- Very Smooth Switching Transition
- Internal Charge Pump to Drive N-channel MOSFET
- User Programmable  $V_{IN} - V_{OUT}$  Vth for Noise Immunity
- Open Drain FAULT Output with Delay
  - Short between any two of the ORing FET Terminals
  - GATE Voltage and Excessive FET  $V_{DS}$
  - Power-Good Indicator (ISL6146C)
- MSOP and DFN Package Options

## Applications

- N+1 Industrial and Telecom Power Distribution Systems
- Uninterruptable Power Supplies
- Low Voltage Processor and Memory
- Storage and Datacom Systems

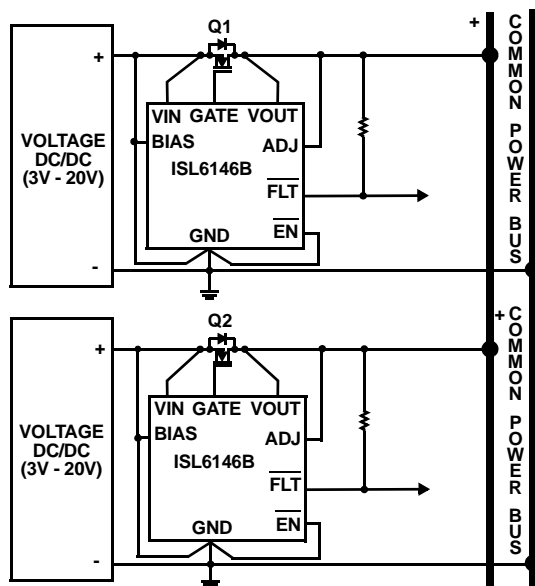

FIGURE 1. TYPICAL APPLICATION

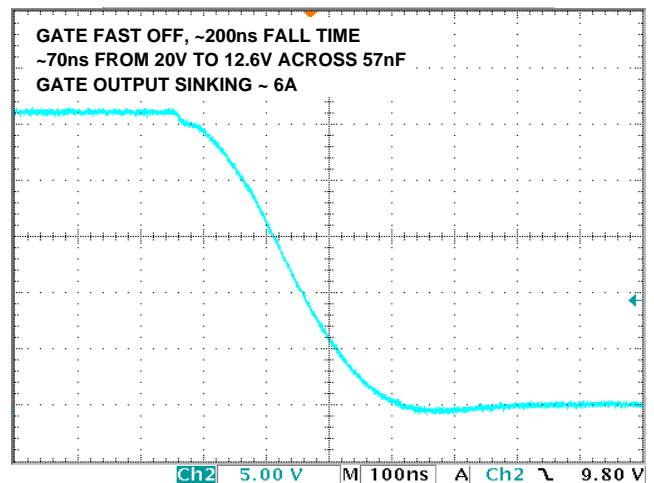
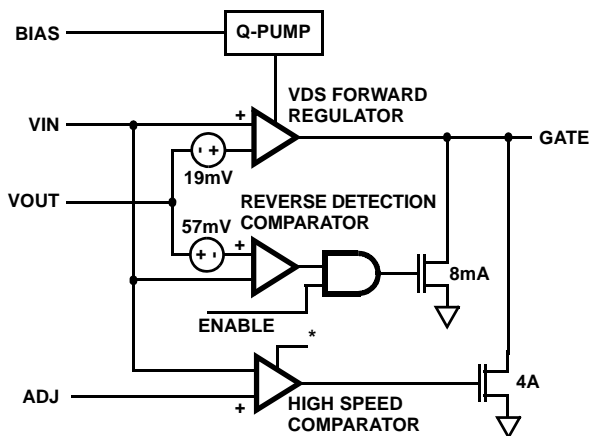

FIGURE 2. ISL6146 GATE HIGH CURRENT PULL-DOWN

## Block Diagram



\* Connected to BIAS on ISL6146A/B/D/E  
Connected to VOUT on ISL6146C

- FAULT DIAGNOSTIC**

  1.  $V_{IN} - V_{OUT} > 570mV$
  2.  $GATE - V_{IN} < 220mV$  (A,B,C only)
  3.  $TEMP > +150^{\circ}C$
  4.  $V_{BIAS} < POR$  (ISL6146A/B/D/E)
  5.  $V_{IN} OR V_{OUT} < POR$  (ISL6146C)
  6.  $V_{IN} < V_{OUT}$
  7. Gate to Drain and Gate to Source Shorts

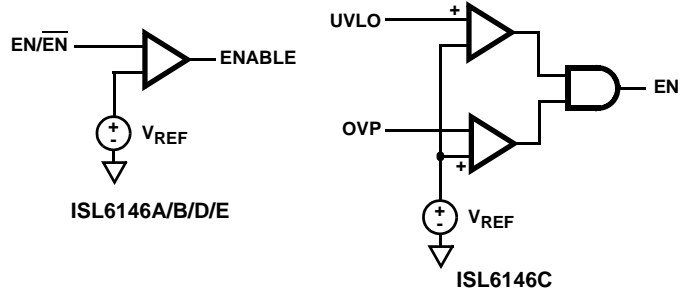

## Pin Configuration

ISL6146  
(8 LD MSOP/DFN)  
TOP VIEW

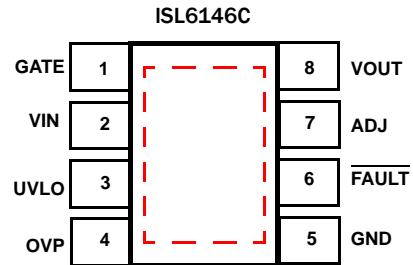
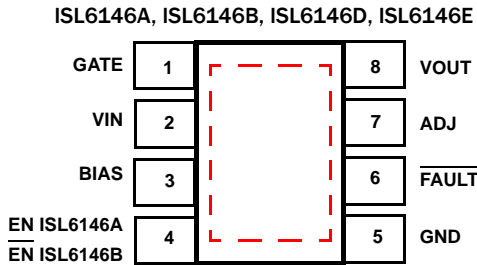

EPAD on DFN only, connect to GND

## Pin Descriptions

MSOP/DFN	SYMBOL	DESCRIPTION
1	GATE	Gate Drive output to the external N-Channel MOSFET generated by the IC internal charge pump. Gate turn-on time is typically <math><1ms</math>. Allows active control of external N-Channel FET gate to perform ORing function. The GATE drive is between <math&gt;v_{in} +="" 12v&lt;="" 7v&lt;="" <math&gt;v_{in}="18V&lt;/math&gt;.&lt;/td" and="" at="" math&gt;=""> </math&gt;v_{in}>
2	VIN	Connected to the sourcing supply side (ORing MOSFET Source), this pin serves as the sense pin to determine the OR'd supply voltage. The ORing MOSFET will be turned off when <math&gt;v_{in}&lt; 0v="" 24v<="" <math&gt;v_{out}&lt;="" a="" becomes="" by="" defaulted="" externally="" internal="" lower="" math&gt;="" more="" or="" range:="" set="" td="" than="" the="" threshold="" threshold.="" to="" value=""> </math&gt;v_{in}&lt;>
3 ISL6146A ISL6146B	BIAS	Primary bias pin. Connected to an independent voltage supply greater than or equal to 3V and greater than <math&gt;v_{in}&lt; 24v<="" 3.0="" math&gt;.="" range:="" td="" to=""> </math&gt;v_{in}&lt;>
3 ISL6146C	UVLO	Programmable UVLO protection to prevent premature turn-on prior to <math&gt;v_{in}&lt; 0v="" 24v<="" adequately="" being="" biased.="" math&gt;="" range:="" td="" to=""> </math&gt;v_{in}&lt;>
4 ISL6146A	EN	Active high enable input to turn on the FET. Internally pulled low to GND through 2M $\Omega$ . Range: 0V to 24V
4 ISL6146B	EN	Active low enable input to turn on the FET. Internally pulled high to BIAS through 2M $\Omega$ . Range: 0 to 24V

# ISL6146

## Pin Descriptions (Continued)

MSOP/ DFN	SYMBOL	DESCRIPTION
4 ISL6146C	OVP	Programmable OV protection to prevent continued operation when the monitored voltage is too high. A back-to-back FET configuration must be employed to implement the OVP capability. Range: 0V to 24V
5	GND	Chip ground reference.
6	$\overline{\text{FAULT}}$	Open-Drain pull-down fault indicating output with internal on chip filtering ( $T_{FLT}$ ). The ISL6146 fault detection circuitry pulls down this pin to GND as it detects a fault or to a disabled input (EN = '0' or EN = '1'). Different types of faults and their detection mechanisms are discussed in more detail on page 17. These faults include: a. GATE is OFF (GATE < $V_{IN} + 0.2V$ ) when enabled [this condition is not reported on the ISL6146D and ISL6146E] b. $V_{IN} - V_{OUT} > 0.57V$ when ON. c. FET G-D or G-S or D-S shorts. d. $V_{IN} < POR_{L2H}$ e. $V_{IN} < V_{OUT}$ f. Over-Temperature Range: 0 to $V_{OUT}$
7	ADJ	Resistor programmable $V_{IN} - V_{OUT}$ Voltage Threshold (Vth) of the High Speed Comparator. This pin is either directly connected to VOUT or can be connected through a 5k $\Omega$ to 100k $\Omega$ resistor to GND. Allows for adjusting the voltage difference threshold to prevent unintended turn-off of the pass FET due to normal system voltage fluctuations. Range: 0.4 to $V_{OUT}$
8	VOUT	The second sensing node for external FET control and connected to the Load side (ORing MOSFET Drain). This is the common connection point for multiple paralleled supplies. $V_{OUT}$ is compared to $V_{IN}$ to determine when the ORing FET has to be turned off. Range: 0V to 24V
PAD	Thermal Pad	Connect to GND

## Ordering Information

PART NUMBER (Notes 1, 2, 3)	PART MARKING	TEMP RANGE (°C)	PACKAGE (Pb-free)	PKG. DWG. #
ISL6146AFUZ	6146A	-40 to +125	8 Ld MSOP	M8.118
ISL6146AFUZ-T	6146A	-40 to +125	8 Ld MSOP Tape and Reel	M8.118
ISL6146AFUZ-T7A	6146A	-40 to +125	8 Ld MSOP Tape and Reel	M8.118
ISL6146AFUZ-TK	6146A	-40 to +125	8 Ld MSOP Tape and Reel	M8.118
ISL6146AFRZ	46AF	-40 to +125	8 Ld 3x3 DFN	L8.3x3J
ISL6146AFRZ-T	46AF	-40 to +125	8 Ld 3x3 DFN Tape and Reel	L8.3x3J
ISL6146AFRZ-T7A	46AF	-40 to +125	8 Ld 3x3 DFN Tape and Reel	L8.3x3J
ISL6146AFRZ-TK	46AF	-40 to +125	8 Ld 3x3 DFN Tape and Reel	L8.3x3J
ISL6146BFUZ	6146B	-40 to +125	8 Ld MSOP	M8.118
ISL6146BFUZ-T	6146B	-40 to +125	8 Ld MSOP Tape and Reel	M8.118
ISL6146BFUZ-T7A	6146B	-40 to +125	8 Ld MSOP Tape and Reel	M8.118
ISL6146BFUZ-TK	6146B	-40 to +125	8 Ld MSOP Tape and Reel	M8.118
ISL6146BFRZ	46BF	-40 to +125	8 Ld 3x3 DFN	L8.3x3J
ISL6146BFRZ-T	46BF	-40 to +125	8 Ld 3x3 DFN Tape and Reel	L8.3x3J
ISL6146BFRZ-T7A	46BF	-40 to +125	8 Ld 3x3 DFN Tape and Reel	L8.3x3J
ISL6146BFRZ-TK	46BF	-40 to +125	8 Ld 3x3 DFN Tape and Reel	L8.3x3J
ISL6146CFUZ	6146C	-40 to +125	8 Ld MSOP	M8.118
ISL6146CFUZ-T	6146C	-40 to +125	8 Ld MSOP Tape and Reel	M8.118
ISL6146CFUZ-T7A	6146C	-40 to +125	8 Ld MSOP Tape and Reel	M8.118
ISL6146CFUZ-TK	6146C	-40 to +125	8 Ld MSOP Tape and Reel	M8.118

# ISL6146

## Ordering Information (Continued)

PART NUMBER (Notes 1, 2, 3)	PART MARKING	TEMP RANGE (°C)	PACKAGE (Pb-free)	PKG. DWG. #
ISL6146CFRZ	46CF	-40 to +125	8 Ld 3x3 DFN	L8.3x3J
ISL6146CFRZ-T	46CF	-40 to +125	8 Ld 3x3 DFN Tape and Reel	L8.3x3J
ISL6146CFRZ-T7A	46CF	-40 to +125	8 Ld 3x3 DFN Tape and Reel	L8.3x3J
ISL6146CFRZ-TK	46CF	-40 to +125	8 Ld 3x3 DFN Tape and Reel	L8.3x3J
ISL6146DFUZ	6146D	-40 to +125	8 Ld MSOP	M8.118
ISL6146DFUZ-T	6146D	-40 to +125	8 Ld MSOP Tape and Reel	M8.118
ISL6146DFUZ-T7A	6146D	-40 to +125	8 Ld MSOP Tape and Reel	M8.118
ISL6146DFUZ-TK	6146D	-40 to +125	8 Ld MSOP Tape and Reel	M8.118
ISL6146DFRZ	46DF	-40 to +125	8 Ld 3x3 DFN	L8.3x3J
ISL6146DFRZ-T	46DF	-40 to +125	8 Ld 3x3 DFN Tape and Reel	L8.3x3J
ISL6146DFRZ-T7A	46DF	-40 to +125	8 Ld 3x3 DFN Tape and Reel	L8.3x3J
ISL6146DFRZ-TK	46DF	-40 to +125	8 Ld 3x3 DFN Tape and Reel	L8.3x3J
ISL6146EFUZ	6146E	-40 to +125	8 Ld MSOP	M8.118
ISL6146EFUZ-T	6146E	-40 to +125	8 Ld MSOP Tape and Reel	M8.118
ISL6146EFUZ-T7A	6146E	-40 to +125	8 Ld MSOP Tape and Reel	M8.118
ISL6146EFUZ-TK	6146E	-40 to +125	8 Ld MSOP Tape and Reel	M8.118
ISL6146EFRZ	46EF	-40 to +125	8 Ld 3x3 DFN	L8.3x3J
ISL6146EFRZ-T	46EF	-40 to +125	8 Ld 3x3 DFN Tape and Reel	L8.3x3J
ISL6146EFRZ-T7A	46EF	-40 to +125	8 Ld 3x3 DFN Tape and Reel	L8.3x3J
ISL6146EFRZ-TK	46EF	-40 to +125	8 Ld 3x3 DFN Tape and Reel	L8.3x3J
ISL6146AEVAL1Z	ISL6146A Evaluation Board			
ISL6146BEVAL1Z	ISL6146B Evaluation Board			
ISL6146CEVAL1Z	ISL6146C Evaluation Board			
ISL6146DEVAL1Z	ISL6146D Evaluation Board			
ISL6146EEVAL1Z	ISL6146E Evaluation Board			

### NOTES:

1. Please refer to [TB347](#) for details on reel specifications.
2. These Intersil Pb-free plastic packaged products employ special Pb-free material sets, molding compounds/die attach materials, and 100% matte tin plate plus anneal (e3 termination finish, which is RoHS compliant and compatible with both SnPb and Pb-free soldering operations). Intersil Pb-free products are MSL classified at Pb-free peak reflow temperatures that meet or exceed the Pb-free requirements of IPC/JEDEC J STD-020.
3. For Moisture Sensitivity Level (MSL), please see device information page for [ISL6146](#). For more information on MSL please see techbrief [TB363](#).

## Table of Contents

<b>Absolute Maximum Ratings</b> .....	<b>6</b>
<b>Thermal Information</b> .....	<b>6</b>
<b>Recommended Operating Conditions</b> .....	<b>6</b>
<b>Electrical Specifications</b> .....	<b>6</b>
<b>Typical Performance Curves</b> .....	<b>9</b>
<b>Functional Description</b> .....	<b>17</b>
Functional Overview .....	17
<b>Applications Information</b> .....	<b>18</b>
Power-Up Considerations .....	18
Typical Applications Circuits .....	18
<b>ISL6146 Evaluation Platforms</b> .....	<b>21</b>
Description and Use of the Evaluation Boards .....	21
<b>Revision History</b> .....	<b>25</b>
<b>Products</b> .....	<b>25</b>
<b>Package Outline Drawing</b> .....	<b>26</b>
L8.3x3J .....	26
M8.118 .....	27

# ISL6146

## Absolute Maximum Ratings

BIAS, VIN, VOUT	-0.3V to +24V
GATE	-0.3V to 40V
EN, $\overline{\text{EN}}$ , UVLO, OVP	-0.3V to +24V
ADJ	-0.3V to V <sub>OUT</sub>
FAULT	-0.3V to V <sub>OUT</sub>
ESD Rating	
Human Body Model (Tested per JESD22-A114E)	2.5kV
Machine Model (Tested per JESD22-A115-A)	250V
Latch Up (Tested per JESD-78B; Class 2, Level A)	100mA

## Thermal Information

Thermal Resistance (Typical)	$\theta_{JA}$ (°C/W)	$\theta_{JC}$ (°C/W)
MSOP Package (Notes 4, 7)	140	41
DFN Package (Notes 5, 6)	46	5
Maximum Junction Temperature (Plastic Package)	+150°C	
Storage Temperature Range	-65°C to +150°C	

## Recommended Operating Conditions

Bias Supply Voltage Range	+3V to +20V
OR'd Supply Voltage Range	+1V to BIAS
Temperature Range (T <sub>A</sub> )	-40°C to +125°C

CAUTION: Do not operate at or near the maximum ratings listed for extended periods of time. Exposure to such conditions may adversely impact product reliability and result in failures not covered by warranty.

### NOTES:

- $\theta_{JA}$  is measured with the component mounted on a high effective thermal conductivity test board in free air. See Tech Brief [TB379](#) for details.
- $\theta_{JA}$  is measured in free air with the component mounted on a high effective thermal conductivity test board with "direct attach" features. See Tech Brief [TB379](#).
- For  $\theta_{JC}$ , the "case temp" location is the center of the exposed metal pad on the package underside.
- For  $\theta_{JC}$ , the "case temp" location is taken at the package top center

**Electrical Specifications** V<sub>CC</sub> = BIAS = 12V, unless otherwise stated. T<sub>A</sub> = +25°C to +85°C. **Boldface limits apply over the operating temperature range, -40°C to +125°C.**

SYMBOL	PARAMETERS	TEST CONDITIONS	MIN (Note 8)	TYP	MAX (Note 8)	UNITS
<b>BIAS</b>						
POR <sub>L2H</sub>	POR Rising	BIAS Rising, GATE Rising	<b>1.9</b>	2.5	<b>2.95</b>	V
POR <sub>HYS</sub>	POR Hysteresis			189		mV
IBIAS_en_18	ISL6146A/B/D/E BIAS Current	BIAS, V <sub>IN</sub> = 18V, ADJ, V <sub>OUT</sub> = 16.98V, enabled		3.6	5	mA
IVIN_en_18	ISL6146A/B/D/E V <sub>IN</sub> Current	BIAS, V <sub>IN</sub> = 18V, ADJ, V <sub>OUT</sub> = 16.98V, enabled		25	40	μA
IVIN_en_18	ISL6146C V <sub>IN</sub> Current	V <sub>IN</sub> = 18V, ADJ, V <sub>OUT</sub> = 16.98V, enabled		3	4.5	mA
IVOUT_en_18	ISL6146A/B/D/E V <sub>OUT</sub> Current	BIAS, V <sub>IN</sub> = 18V, V <sub>OUT</sub> = 16.98V, enabled		14	20	μA
VOUT_en_18	ISL6146C V <sub>OUT</sub> Current	V <sub>IN</sub> = 18V, V <sub>OUT</sub> = 16.98V, enabled		400	500	μA
IBIAS_den_18	ISL6146A/B/D/E BIAS Current	BIAS, V <sub>IN</sub> = 18V, ADJ, V <sub>OUT</sub> = 16.98V, disabled		1.7	3	mA
IVIN_den_18	ISL6146A/B/D/E V <sub>IN</sub> Current	BIAS, V <sub>IN</sub> = 18V, ADJ, V <sub>OUT</sub> = 16.98V, disabled		27	37	μA
IVIN_den_18	ISL6146C V <sub>IN</sub> Current	V <sub>IN</sub> = 18V, ADJ, V <sub>OUT</sub> = 16.98V, disabled		1.3	1.5	mA
IVOUT_den_18	ISL6146A/B/D/E V <sub>OUT</sub> Current	BIAS, V <sub>IN</sub> = 18V, V <sub>OUT</sub> = 16.98V, disabled		14	20	μA
IVOUT_den_18	ISL6146C V <sub>OUT</sub> Current	V <sub>IN</sub> = 18V, V <sub>OUT</sub> = 16.98V, disabled		385	500	μA
t <sub>BIAS2GTE</sub>	BIAS to GATE Delay	BIAS > POR <sub>L2H</sub> to GATE Rising		150	210	μs
<b>GATE</b>						
V <sub>GH_3</sub>	Charge Pump Voltage	V <sub>IN</sub> , BIAS = 3V V <sub>IN</sub> - V <sub>OUT</sub> > V <sub>FWD_VR</sub>	<b>V<sub>IN</sub>+5V</b>	V <sub>IN</sub> +7V	<b>V<sub>IN</sub>+10.5V</b>	V
V <sub>GH_12</sub>	Charge Pump Voltage	V <sub>IN</sub> , BIAS = 12V V <sub>IN</sub> - V <sub>OUT</sub> > V <sub>FWD_VR</sub>	<b>V<sub>IN</sub>+9V</b>	V <sub>IN</sub> +10V	<b>V<sub>IN</sub>+17.5V</b>	V
V <sub>GH_18</sub>	Charge Pump Voltage	V <sub>IN</sub> , BIAS = 18V V <sub>IN</sub> - V <sub>OUT</sub> > V <sub>FWD_VR</sub>	<b>V<sub>IN</sub>+9V</b>	V <sub>IN</sub> +10V	<b>V<sub>IN</sub>+18V</b>	V
V <sub>GL</sub>	Low Voltage Level	V <sub>IN</sub> - V <sub>OUT</sub> < 0V		0	<b>0.1</b>	V
I <sub>PDL</sub>	Low Pull-Down Current	V <sub>IN</sub> = 12V, V <sub>OUT</sub> = 12.2V ADJ = 11V	<b>5</b>	8.4	<b>13</b>	mA
I <sub>PDH</sub>	High Pull-Down Current	V <sub>IN</sub> falling from 12V to 10V in 2μs	<b>3.5</b>	6.5		A
t <sub>toff</sub>	Fast Turn-off Time	V <sub>IN</sub> = V <sub>BIAS</sub> = 12V, V <sub>GATE</sub> = 18V to 10V, C <sub>GATE</sub> = 57nF		65	<b>130</b>	ns

# ISL6146

**Electrical Specifications**  $V_{CC} = \text{BIAS} = 12\text{V}$ , unless otherwise stated.  $T_A = +25^\circ\text{C}$  to  $+85^\circ\text{C}$ . **Boldface limits apply over the operating temperature range,  $-40^\circ\text{C}$  to  $+125^\circ\text{C}$ .** (Continued)

SYMBOL	PARAMETERS	TEST CONDITIONS	MIN (Note 8)	TYP	MAX (Note 8)	UNITS
$t_{\text{toffs}}$	Slow Turn-off Time	$V_{\text{IN}} = V_{\text{BIAS}} = 12\text{V}$ , $V_{\text{GATE}} = 18\text{V}$ to $10\text{V}$ , $C_{\text{GATE}} = 57\text{nF}$		58	<b>80</b>	$\mu\text{s}$
$I_{\text{ON}}$	Turn-On Current	$\text{BIAS} = 12\text{V}$ , $V_{\text{G}} = 0\text{V}$		1		mA
		$\text{BIAS} = 12\text{V}$ , $V_{\text{G}} = 20\text{V}$		0.15		mA
$V_{\text{VG\_FLTr}}$	GATE to $V_{\text{IN}}$ Rising Fault Voltage	GATE > $V_{\text{IN}}$ , enabled, $\overline{\text{FLT}}$ output is high. (Does not apply to ISL6146D and ISL6146E)	<b>320</b>	440	<b>560</b>	mV
$V_{\text{VG\_FLTf}}$	GATE to $V_{\text{IN}}$ Falling Fault Voltage	GATE > $V_{\text{IN}}$ , enabled, $\overline{\text{FLT}}$ output is low. (Does not apply to ISL6146D and ISL6146E)	<b>140</b>	220	<b>300</b>	mV
<b>CONTROL AND REGULATION I/O</b>						
$V_{\text{Rr}}$	Reverse Voltage Detection Rising $V_{\text{OUT}}$ Threshold	$V_{\text{OUT}}$ rising	<b>35</b>	57	<b>79</b>	mV
$V_{\text{Rf}}$	Reverse Voltage Detection Falling $V_{\text{OUT}}$ Threshold	$V_{\text{OUT}}$ falling	<b>10</b>	30	<b>51</b>	mV
$t_{\text{RS}}$	Reverse Voltage Detection Response Time			10		$\mu\text{s}$
$V_{\text{FWD\_VR}}$	Amplifier Forward Voltage Regulation	ISL6146 controls voltage across FET $V_{\text{DS}}$ to $V_{\text{FWD\_VR}}$ during static forward operation at loads resulting in $I_{\text{d}} * r_{\text{DS(ON)}} < V_{\text{FWD\_VR}}$	<b>11</b>	19	<b>28</b>	mV
$V_{\text{OS\_HS}}$	HS Comparator Input Offset Voltage		<b>-14</b>	0.7	<b>14</b>	mV
$V_{\text{TH(HS5k)}}$	ADJ Adjust Threshold with 5k to GND	$R_{\text{ADJ}} = 5\text{k}\Omega$ to GND	<b>0.57</b>	0.8	<b>1.1</b>	V
$V_{\text{TH(HS100k)}}$	ADJ Adjust Threshold with 100k to GND	$R_{\text{ADJ}} = 100\text{k}\Omega$ to GND	<b>10</b>	40	<b>95</b>	mV
$t_{\text{HSpd}}$	HS Comparator Response Time	$V_{\text{OUT}} > V_{\text{IN}}$ , 1ns transition, 5V differential		170		ns
$V_{\text{FWD\_FLT}}$	$V_{\text{IN}}$ to $V_{\text{OUT}}$ Forward Fault Voltage	$V_{\text{IN}} > V_{\text{OUT}}$ , GATE is fully on, $\overline{\text{FLT}}$ output is low	330	450	570	mV
$V_{\text{FWD\_FLT\_HYS}}$	$V_{\text{IN}}$ to $V_{\text{OUT}}$ Forward Fault Voltage Hysteresis	$V_{\text{IN}} > V_{\text{OUT}}$ , GATE is fully on, $\overline{\text{FLT}}$ output is high		44		mV
<b>FAULT OUTPUT</b>						
$I_{\text{FLT\_SINK}}$	$\overline{\text{FAULT}}$ Sink Current	$\text{BIAS} = 18\text{V}$ $\overline{\text{FAULT}} = 0.5\text{V}$ , $V_{\text{IN}} < V_{\text{OUT}}$ , $V_{\text{GATE}} = V_{\text{GL}}$	<b>5</b>	9		mA
$I_{\text{FLT\_LEAK}}$	$\overline{\text{FAULT}}$ Leakage Current	$\overline{\text{FAULT}} = "V_{\text{FLT\_H}}"$ , $V_{\text{IN}} > V_{\text{OUT}}$ , $V_{\text{GATE}} = V_{\text{IN}} + V_{\text{GQP}}$		0.04	<b>10</b>	$\mu\text{A}$
$t_{\text{FLT\_L2H}}$	$\overline{\text{FAULT}}$ Low to High Delay	GATE = $V_{\text{GQP}}$ to $\overline{\text{FAULT}}$ output is high		10	<b>23</b>	$\mu\text{s}$
$t_{\text{FLT\_H2L}}$	$\overline{\text{FAULT}}$ High to Low Delay	GATE = $V_{\text{IN}}$ to $\overline{\text{FAULT}}$ output is low		1.7	<b>3</b>	$\mu\text{s}$
<b>ENABLE UVLO/OVP/ADJ INPUTS</b>						
$V_{\text{thRa}}$	ISL6146A/D EN Rising $V_{\text{th}}$		<b>580</b>	606	<b>631</b>	mV
$V_{\text{thR\_hysa}}$	ISL6146A/D EN $V_{\text{th}}$ Hysteresis			-90		mV
$V_{\text{thFb}}$	ISL6146B/E $\overline{\text{EN}}$ Falling $V_{\text{th}}$		<b>580</b>	606	<b>631</b>	mV
$V_{\text{thF\_hysb}}$	ISL6146B/E $\overline{\text{EN}}$ $V_{\text{th}}$ Hysteresis			+90		mV
$V_{\text{thFc}}$	ISL6146C OVP Falling $V_{\text{th}}$		<b>580</b>	606	<b>631</b>	mV
$V_{\text{thF\_hysc}}$	ISL6146C OVP $V_{\text{th}}$ Hysteresis			+90		mV
$V_{\text{thRc}}$	ISL6146C UVLO Rising $V_{\text{th}}$		<b>580</b>	606	<b>631</b>	mV
$V_{\text{thR\_hysc}}$	ISL6146C UVLO $V_{\text{th}}$ Hysteresis			-90		mV
$t_{\text{EN2GTER}}$	EN/UVLO Rising to GATE Rising Delay			10	<b>12</b>	$\mu\text{s}$
	$\overline{\text{EN}}$ /OVP Falling to GATE Rising Delay			9	<b>12</b>	$\mu\text{s}$

# ISL6146

**Electrical Specifications**  $V_{CC} = \text{BIAS} = 12\text{V}$ , unless otherwise stated.  $T_A = +25^\circ\text{C}$  to  $+85^\circ\text{C}$ . **Boldface limits apply over the operating temperature range,  $-40^\circ\text{C}$  to  $+125^\circ\text{C}$ .** (Continued)

SYMBOL	PARAMETERS	TEST CONDITIONS	MIN (Note 8)	TYP	MAX (Note 8)	UNITS
$t_{EN2GTEF}$	EN/UVLO Falling to GATE Falling Delay			2	<b>4</b>	$\mu\text{s}$
	$\overline{\text{EN}}$ /OVP Rising to GATE Falling Delay			2	<b>4</b>	$\mu\text{s}$
Ren_h	ENABLE Pull-Down Resistor	ISL6146A		2		$\text{M}\Omega$
Ren_l	$\overline{\text{ENABLE}}$ Pull-Up Resistor	ISL6146B		2		$\text{M}\Omega$
Vadj	ADJ Pin Voltage	$R_{\text{ADJ}}$ 5k $\Omega$ to 100k $\Omega$		0.4		V
Radj	ADJ Pull-Up Resistor	Internal ADJ Pull-up Resistor to $V_{\text{OUT}}$		3.85		$\text{M}\Omega$
OTS	Over-Temperature Sense	Fault signals in operation		140		$^\circ\text{C}$
OTSHYS	Over-Temperature Sense Hysteresis			20		$^\circ\text{C}$
HTS	High Temperature Sense	Fault signals upon enabling		125		$^\circ\text{C}$

NOTE:

8. Compliance to datasheet limits is assured by one or more methods: production test, characterization and/or design.



## Typical Performance Curves

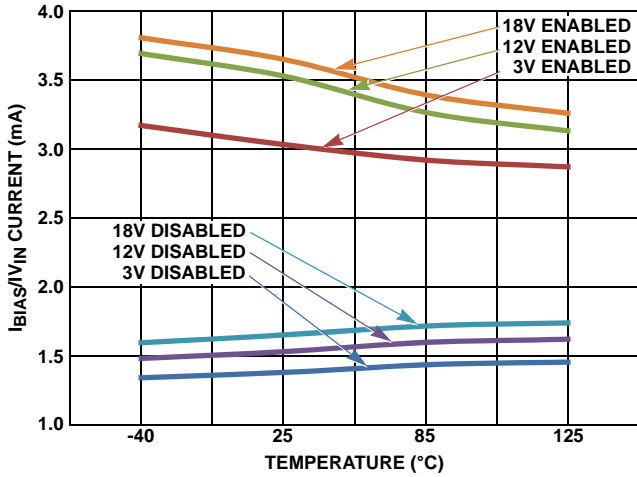

FIGURE 3. ISL6146A/B/D/E BIAS AND ISL6146C  $V_{IN}$  CURRENT vs TEMPERATURE

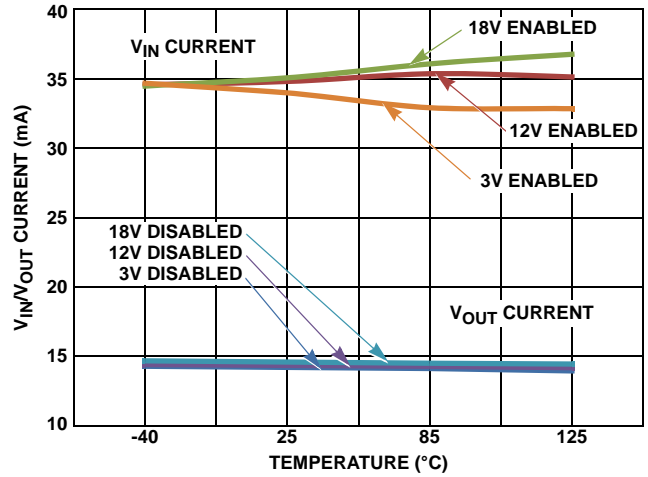

FIGURE 4. ISL6146A/B/C/D/E  $V_{IN}$  AND  $V_{OUT}$  CURRENT vs TEMPERATURE

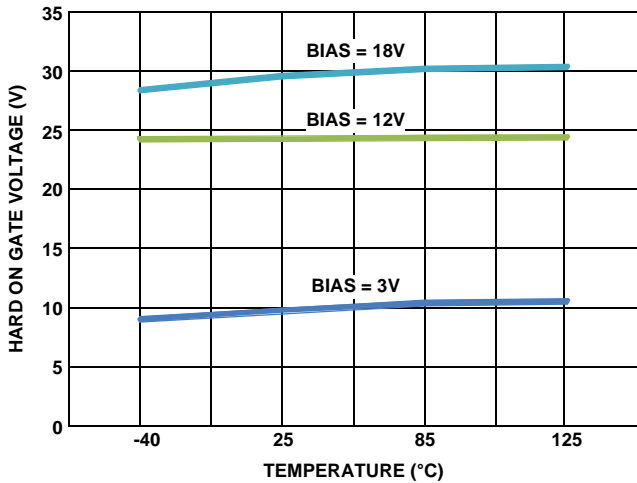

FIGURE 5. GATE VOLTAGE vs TEMPERATURE

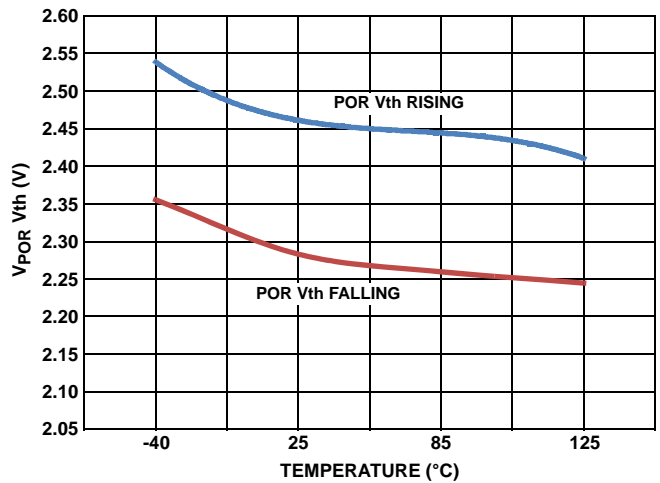

FIGURE 6. POR  $V_{th}$  RISING AND FALLING VOLTAGE

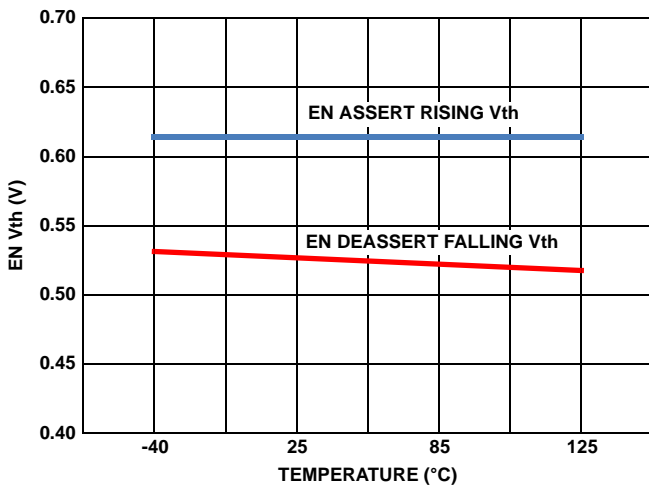

FIGURE 7. ISL6146A/D EN  $V_{th}$  vs TEMPERATURE

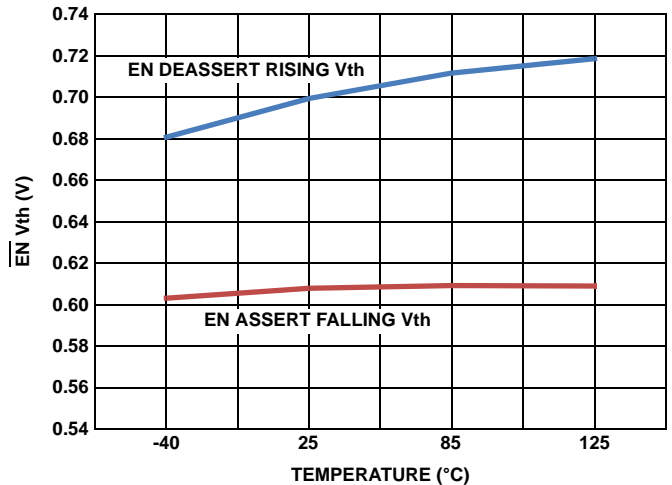

FIGURE 8. ISL6146B/E EN  $V_{th}$  vs TEMPERATURE

## Typical Performance Curves (Continued)

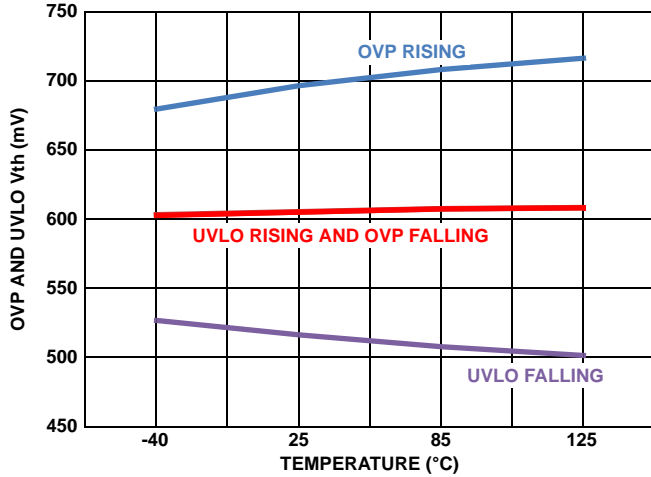

FIGURE 9. ISL6146C UVLO/OVP Vth vs TEMPERATURE

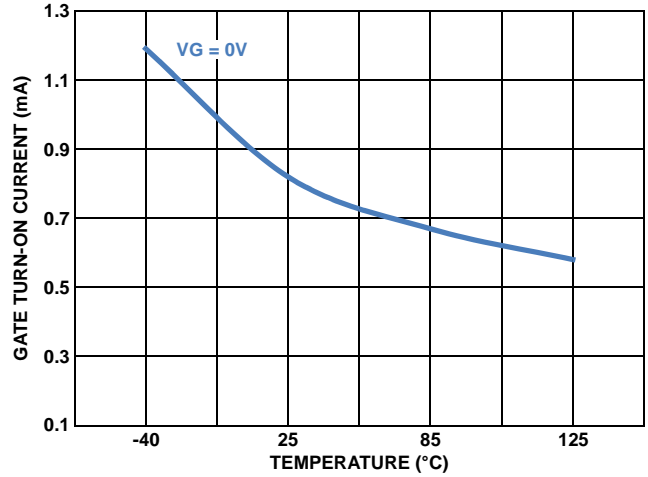

FIGURE 10. GATE TURN-ON CURRENT  $V_{IN} = 12V$

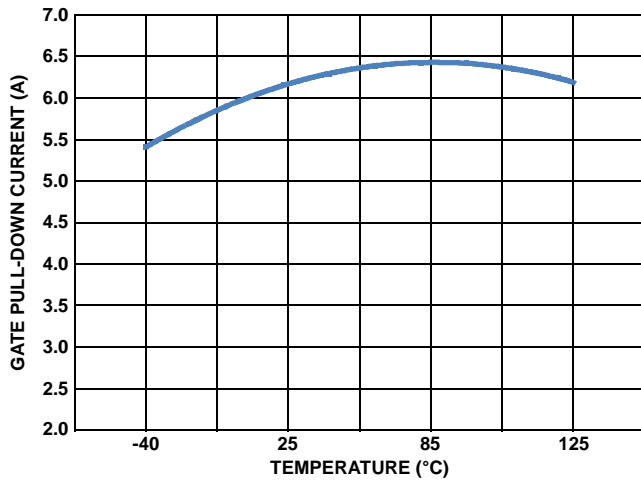

FIGURE 11. GATE HARD TURN-OFF CURRENT

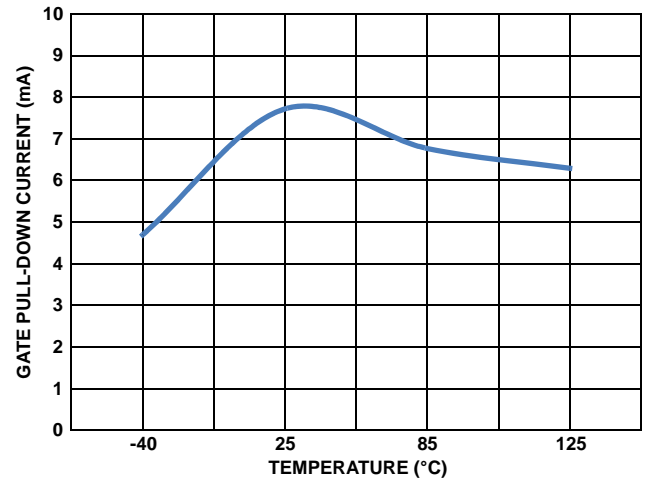

FIGURE 12. GATE SLOW TURN-OFF CURRENT

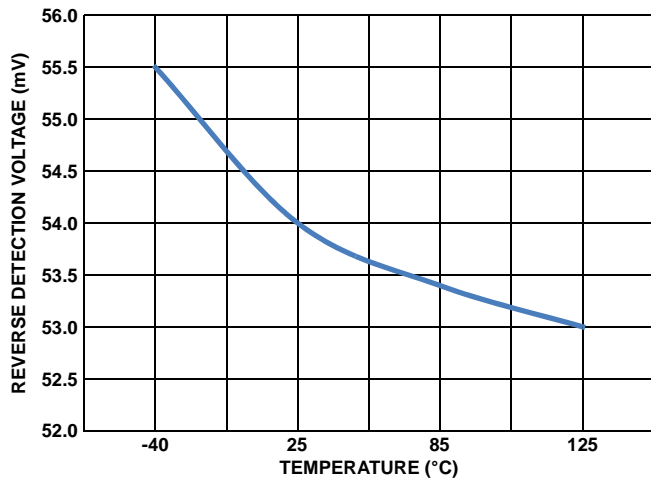

FIGURE 13. INCREASING REVERSE VOLTAGE DETECTION Vth

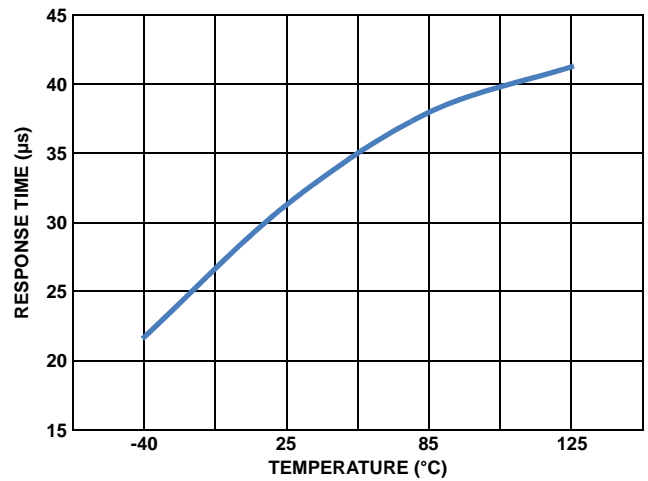

FIGURE 14. REVERSE VOLTAGE RESPONSE TIME

## Typical Performance Curves (Continued)

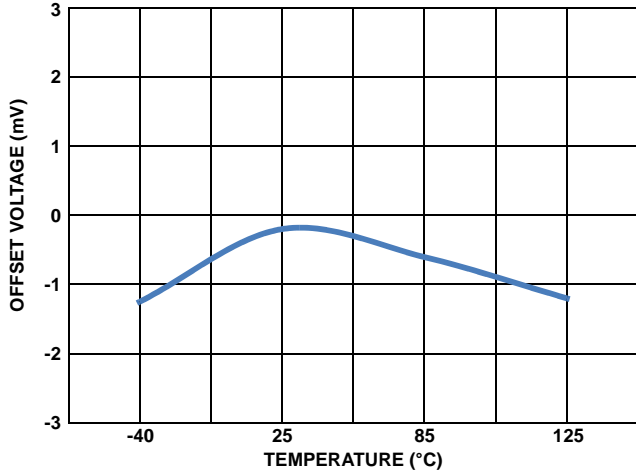

FIGURE 15. HIGH SPEED COMPARATOR OFFSET VOLTAGE

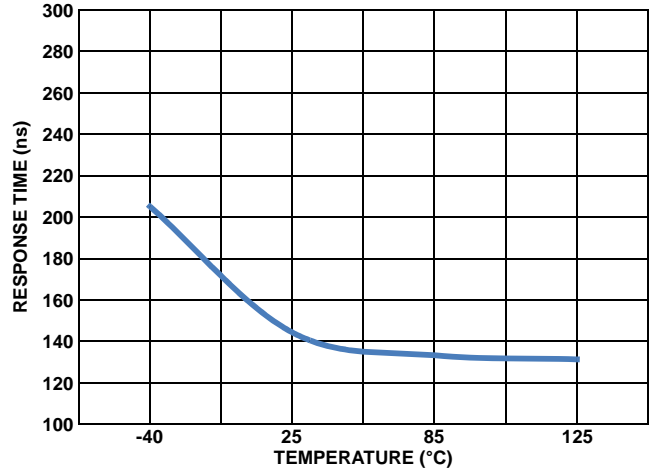

FIGURE 16. HIGH SPEED COMPARATOR RESPONSE TIME

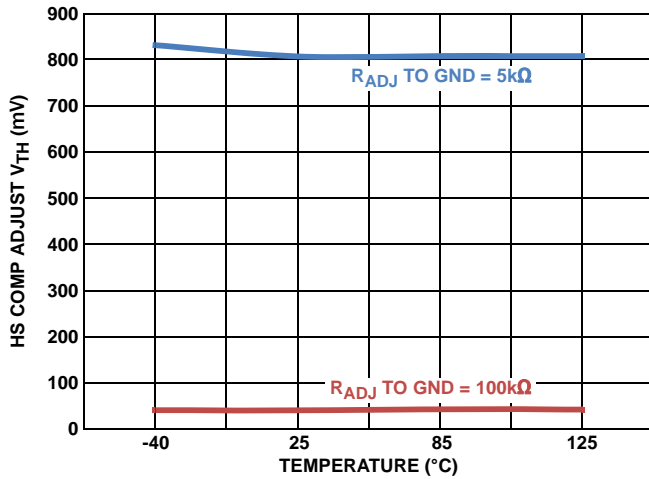

FIGURE 17. HS COMPARATOR ADJUSTABLE V<sub>th</sub>

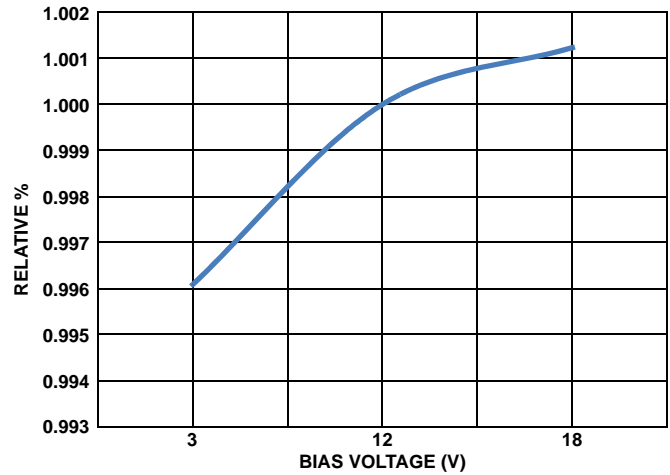

FIGURE 18. EN/EN/UVLO V<sub>th</sub> DELTA vs BIAS VOLTAGE NORMALIZED TO BIAS = 12V

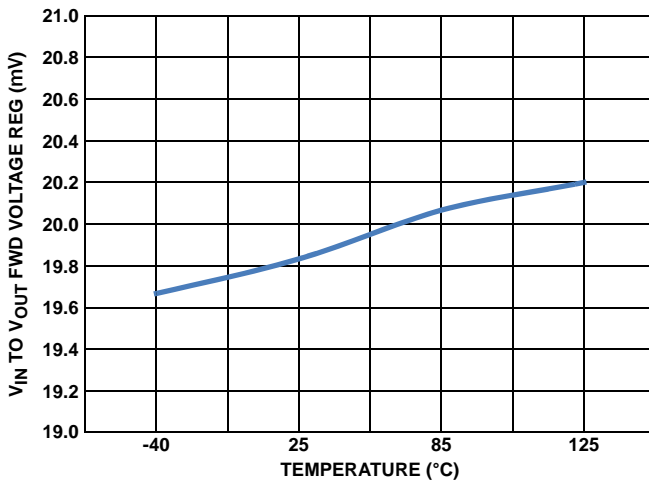

FIGURE 19. FORWARD VOLTAGE REGULATION

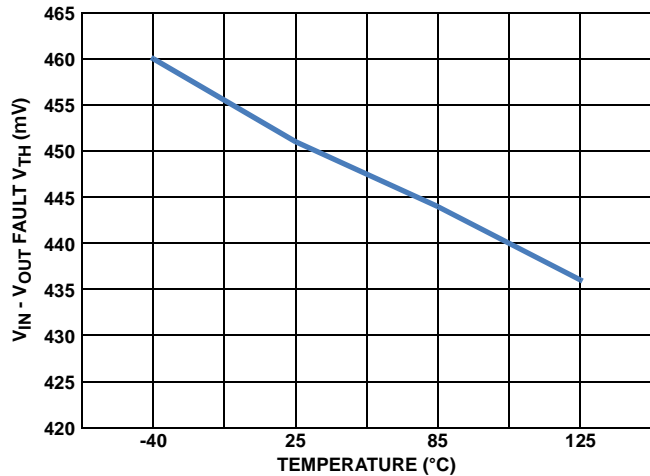

FIGURE 20. V<sub>IN</sub> TO V<sub>OUT</sub> FORWARD FAULT VOLTAGE

## Typical Performance Curves (Continued)

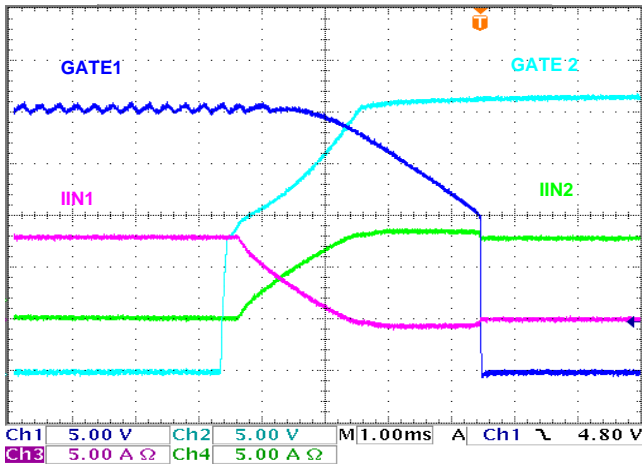

FIGURE 21. ISL6146C SLOW RAMP CONNECT 12V ORing

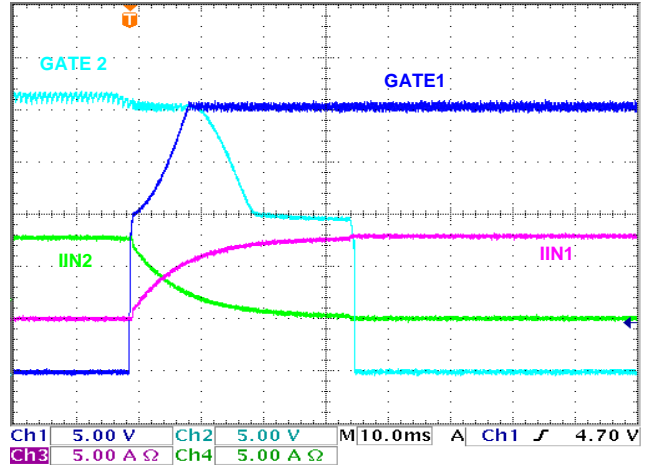

FIGURE 22. ISL6146C SLOW RAMP DISCONNECT 12V ORing

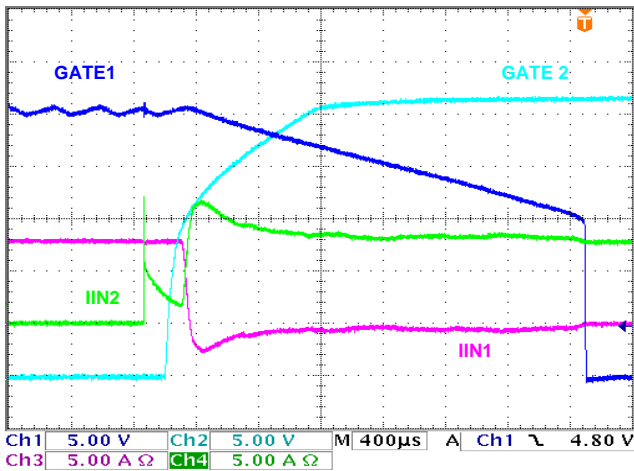

FIGURE 23. ISL6146C HOT SWAP CONNECT 12V ORing

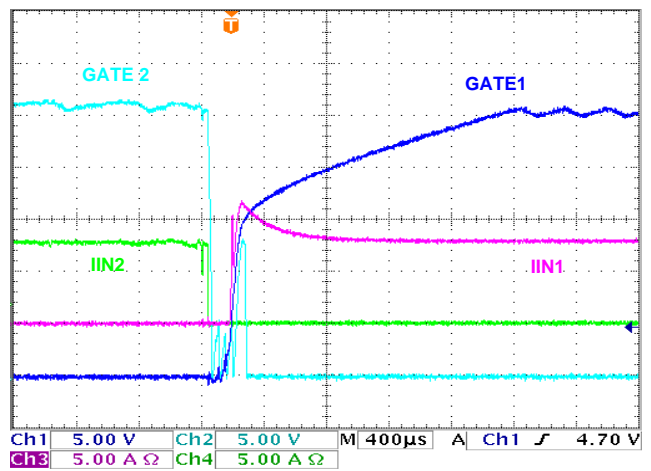

FIGURE 24. ISL6146C HOT DISCONNECT 12V ORing

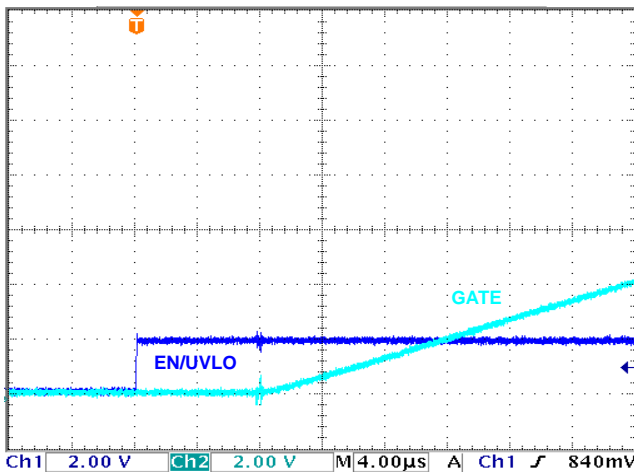

FIGURE 25. ISL6146A/D EN/ISL6146C UVLO TO GATE ON DELAY

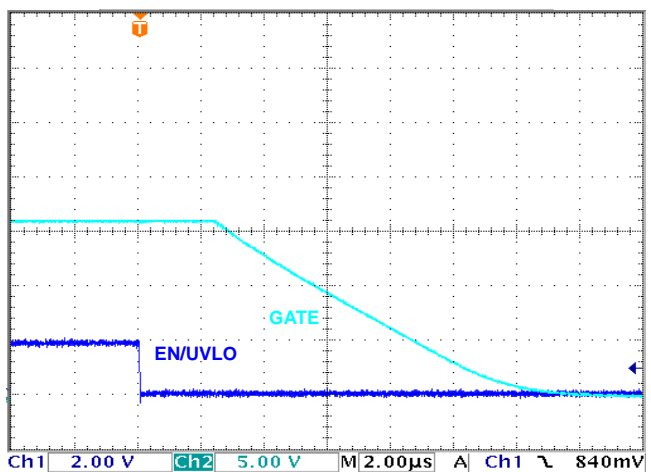

FIGURE 26. ISL6146A/D EN/ISL6146C UVLO TO GATE OFF DELAY

## Typical Performance Curves (Continued)

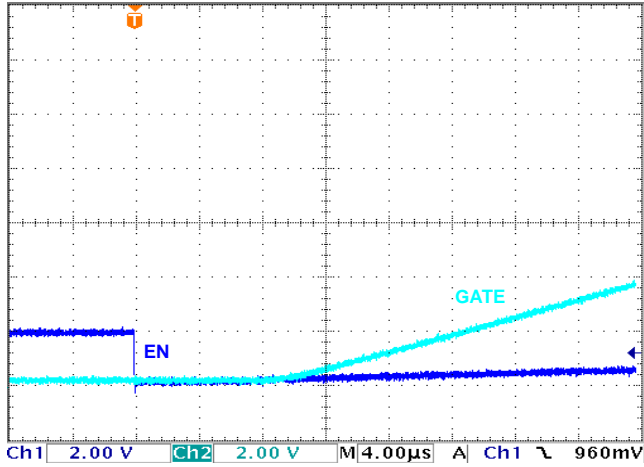

FIGURE 27. ISL6146B/E  $\overline{EN}$  TO GATE ON DELAY

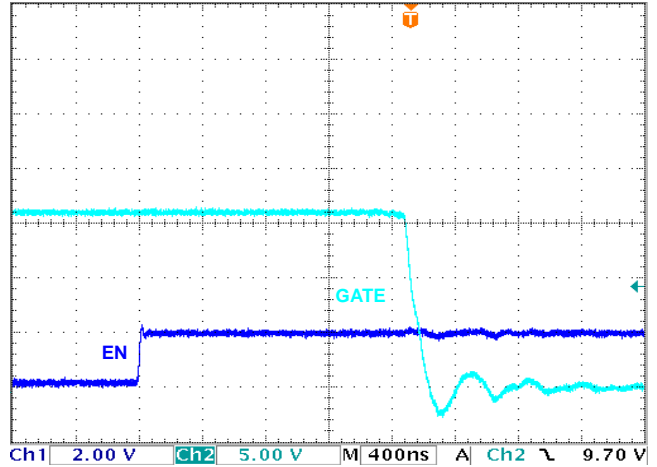

FIGURE 28. ISL6146B/E  $\overline{EN}$  TO GATE OFF DELAY

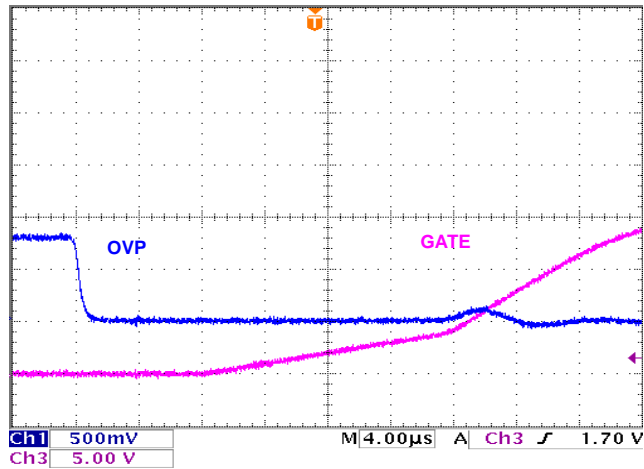

FIGURE 29. ISL6146C OVP TO GATE ON DELAY

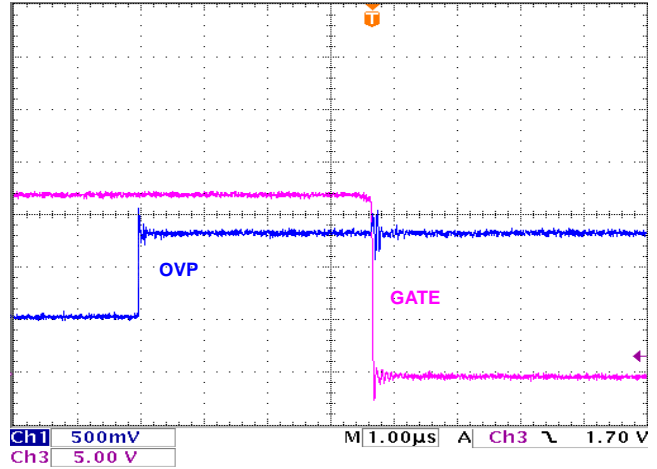

FIGURE 30. ISL6146C OVP TO GATE OFF DELAY

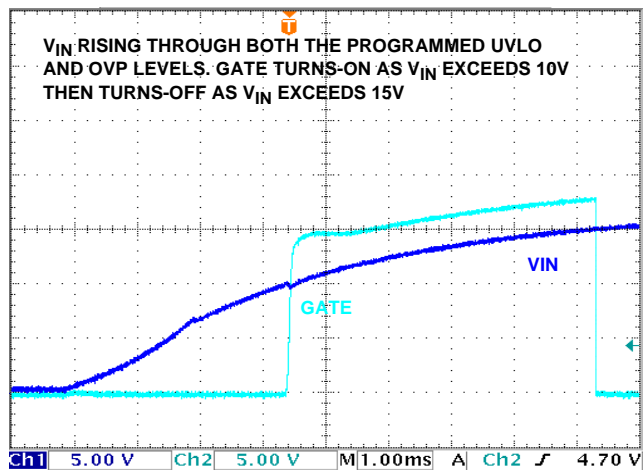

FIGURE 31. ISL6146C RISING  $V_{IN}$ , UVLO AND OVP FUNCTION

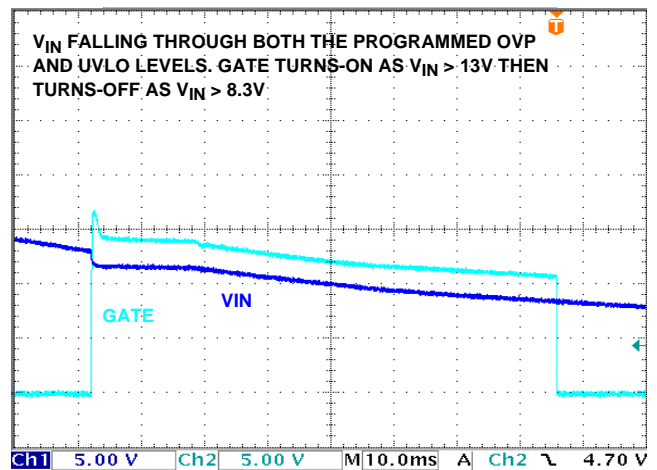

FIGURE 32. ISL6146C FALLING,  $V_{IN}$  OVP AND UVLO FUNCTION

Typical Performance Curves (Continued)

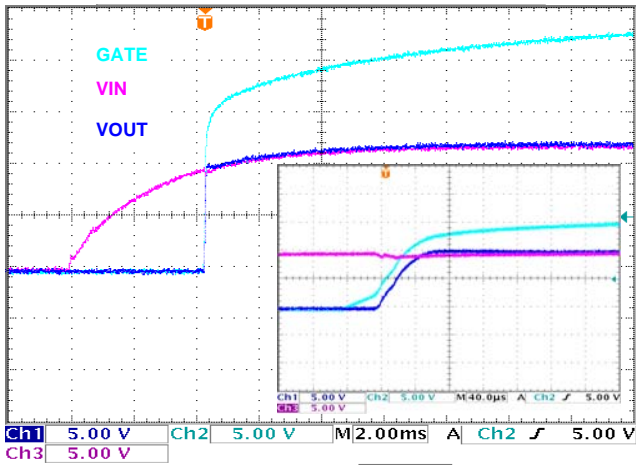

FIGURE 33. BACK-TO-BACK FET TURN\_ON DETAIL

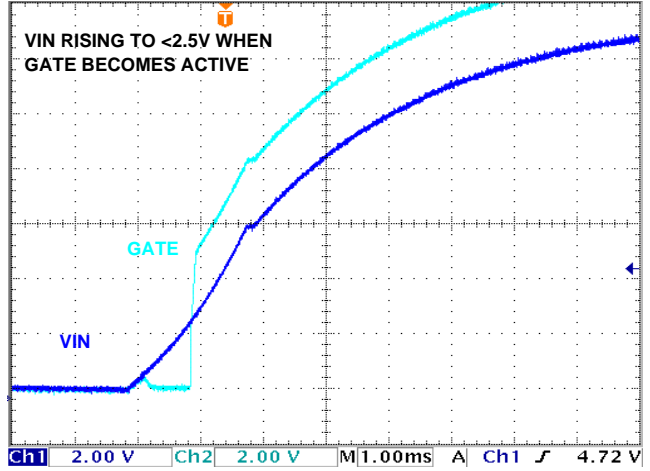

FIGURE 34. ISL6146 RISING POR  $V_{th}$

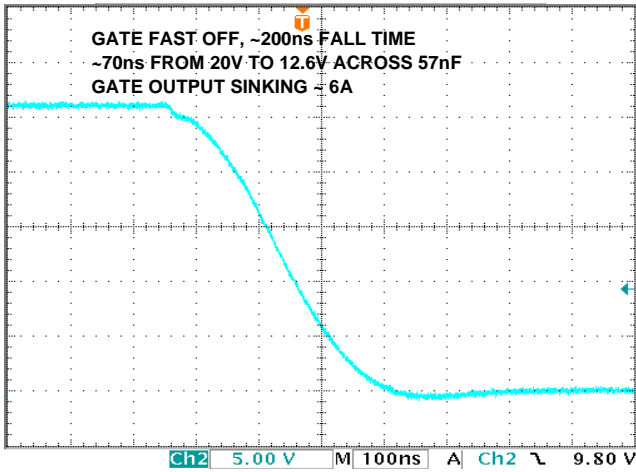

FIGURE 35. FAST GATE TURN-OFF WITH 57nF GATE

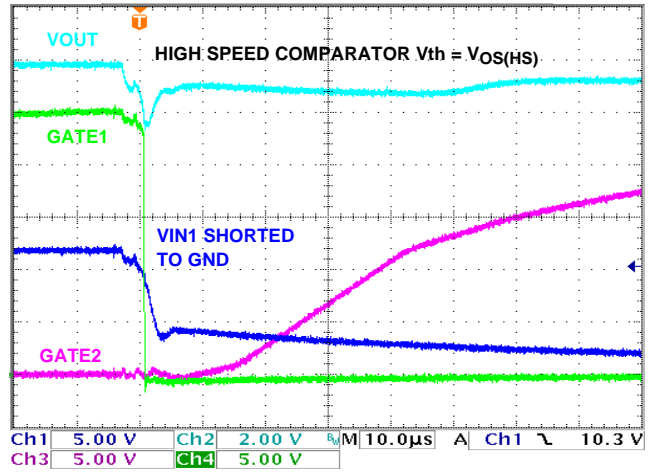

FIGURE 36. RESPONSE TO  $V_{IN}$  SHORTED TO GND WITH ADJ SHORTED TO  $V_{OUT}$

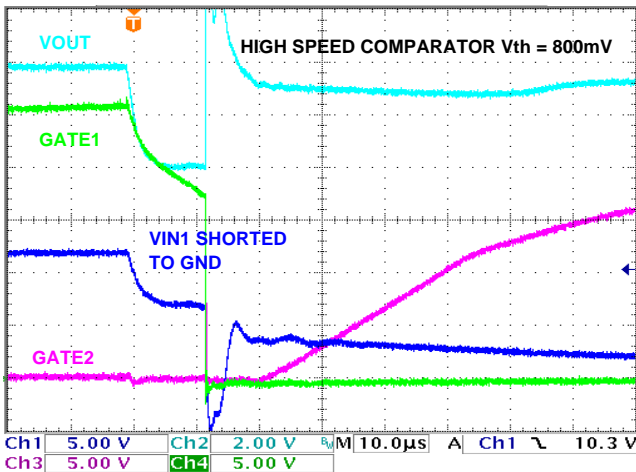

FIGURE 37. RESPONSE TO  $V_{IN}$  SHORTED TO GND WITH ADJ 5k $\Omega$  TO GND

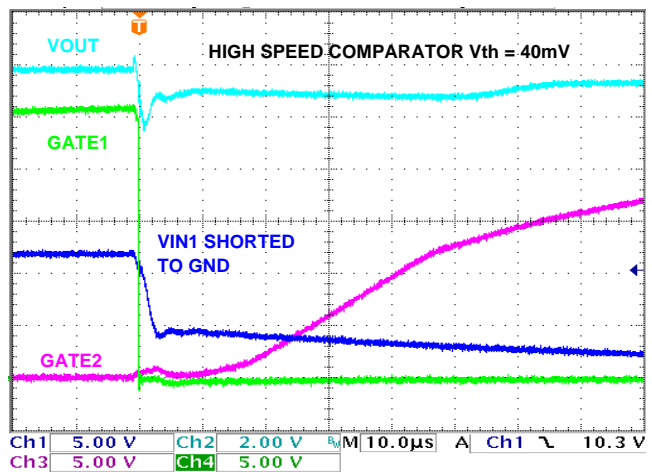

FIGURE 38. RESPONSE TO  $V_{IN}$  SHORTED TO GND WITH ADJ 100k $\Omega$  TO GND

Typical Performance Curves (Continued)

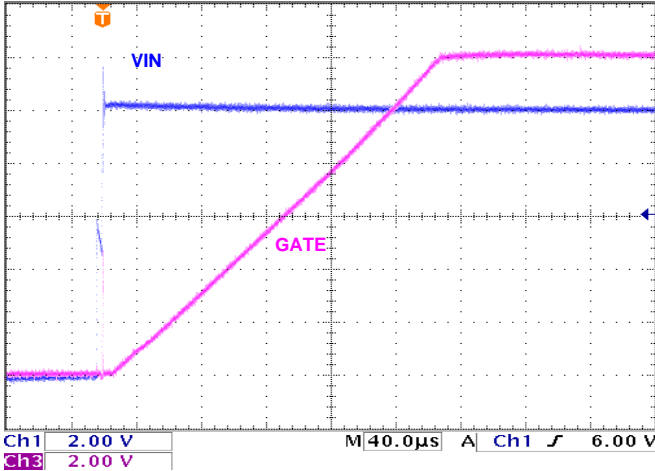

FIGURE 39.  $V_{IN}$  HOT SWAPPED TO GATE WITH BIAS = 12V NO LOAD

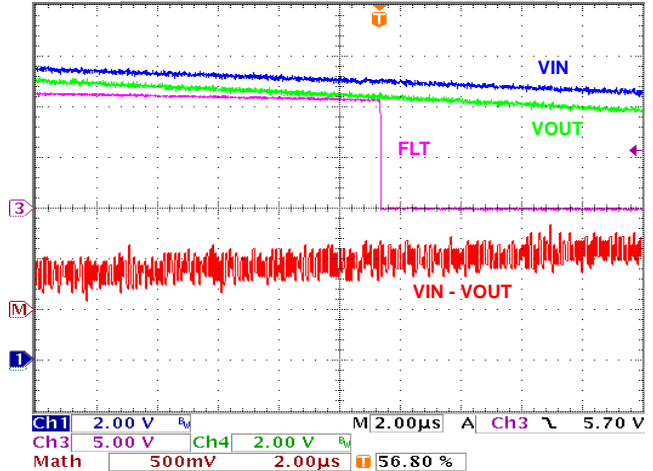

FIGURE 40. FAULT ASSERTING  $V_{IN}$  TO  $V_{OUT} > V_{FWD\_FLT}$

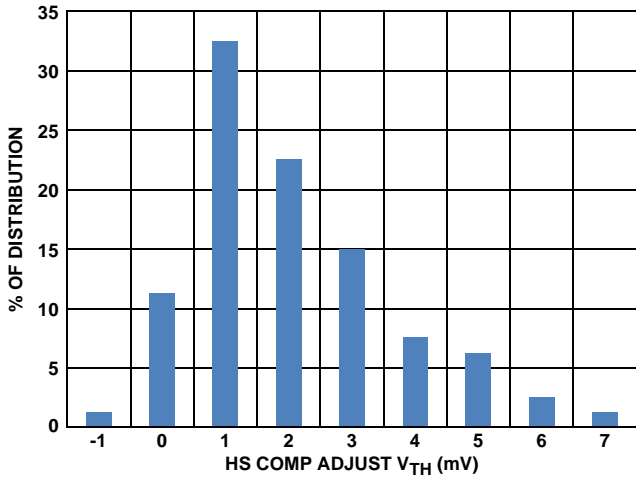

FIGURE 41. HIGH SPEED COMPARATOR OFFSET VOLTAGE DISTRIBUTION

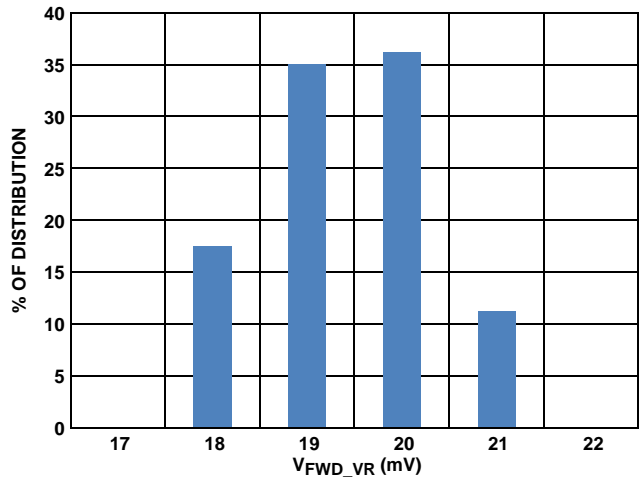

FIGURE 42. FORWARD REGULATION VOLTAGE DISTRIBUTION

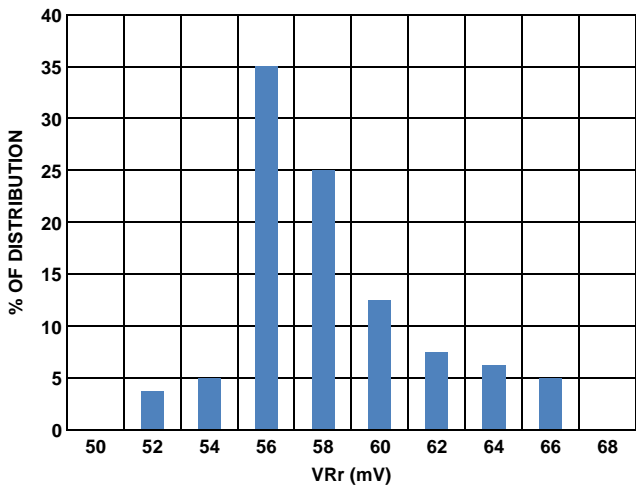

FIGURE 43. REVERSE DETECTION RISING VOLTAGE DISTRIBUTION

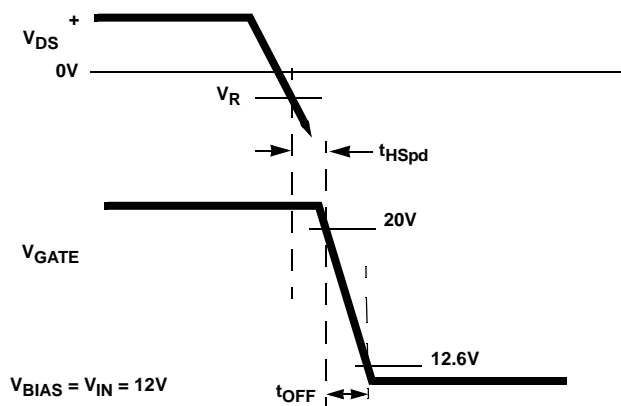

FIGURE 44. FAST RAMP REVERSE PROTECTION TIMING DIAGRAM

## Typical Performance Curves (Continued)

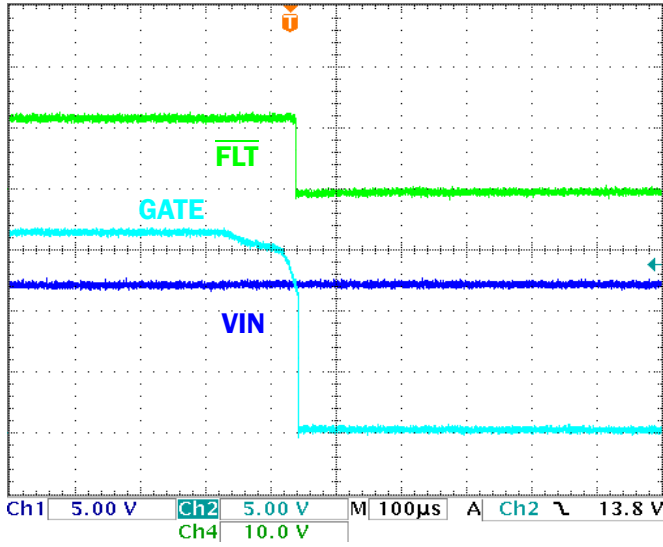

FIGURE 45. ISL6146A FLT RESPONSE TO NON-CONDUCTION

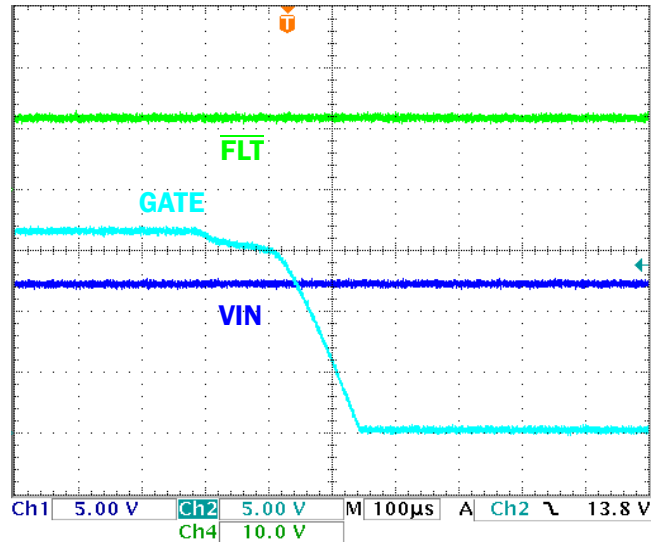

FIGURE 46. ISL6146D FLT RESPONSE TO NON-CONDUCTION



## Functional Description

### Functional Overview

In a redundant power distribution system, similar potential and parallel power supplies each contribute to the load current through various active and passive current sharing schemes. Typically ORing power diodes are used to protect against reverse current flow in the event that one of the power supplies falls below the common bus voltage or develops a catastrophic failure. However, using a discrete ORing diode solution has some significant drawbacks. The primary downside is the increased power dissipation loss in the ORing diodes as system power requirements increase. At the lowest voltages where the ISL6146 is designed for use, the voltage distribution losses across an ORing diode can be a significant percentage, in some cases approaching 70%. Another disadvantage when using an ORing diode is failure to detect a shorted or opened current path, which jeopardizes system power availability and reliability. An open diode may reduce the system to a single point of failure while a shorted diode eliminates the system's power protection.

Using an active ORing FET controller, such as the ISL6146, helps with these potential issues. The use of a low on-resistance FET as the ORing component allows for a more efficient system design as the voltage across the FET is much lower than that across a forward biased diode. Additionally, the ISL6146 has a dedicated fault ( $\overline{\text{FAULT}}$ ) output pin that indicates when there is a conditional or FET fault short providing the diagnostic capability that a diode is unable to.

The ISL6146 is designed to OR together voltages as low as 1V when supplied with a separate bias supply of 3V or greater. Otherwise, the ISL6146 is designed to be biased from and OR voltages across the 3V to 20V nominal supply range.

In a single FET configuration as voltage is first applied to a VIN pin, the FET body diode conducts providing all the ISL6146s connected on a common bus circuit, bias via the VOUT pins. As individual power supply voltages ramp up in excess of the rising POR threshold, the ISL6146's internal charge pump activates to provide a floating gate drive voltage for the external N-channel ORing MOSFET, thus turning the FETs on once  $V_{IN} > V_{OUT}$ . The ISL6146 continuously monitors the drain and source of the ORing FET and provides a reverse voltage (N-channel MOSFET  $V_{OUT} - V_{IN}$ ) detection threshold (VR) that, when exceeded, indicates a reverse current condition. Once this threshold is exceeded, the ISL6146 turns off the ORing FET by pulling down the GATE pin to GND. The ISL6146 also provides high speed  $V_{OUT} > V_{IN}$  transient protection as in the case of a catastrophic VIN failure. The ISL6146 additionally provides for adjustment of the  $V_{IN} - V_{OUT}$  reverse voltage  $V_{th}(VR)$  via the ADJ pin of the ISL6146 with an external resistor to GND. This allows adjusting the  $V_{IN} - V_{OUT}$  voltage threshold level to compensate for normal system voltage fluctuations, thus eliminating unnecessary reaction by the ISL6146.

The total  $V_{IN} - V_{OUT}$  VR  $V_{th}$  is the sum of both the internal offset and the external programmed VR  $V_{th}$ .

In the event of a  $V_{OUT} > V_{IN}$  condition, the ISL6146 responds either with a high or low current pull-down on the GATE pin depending on whether the High Speed comparator (HSCOMP) has been activated or not. The HSCOMP determines if the VR occurred within 1 $\mu$ s, by continuously monitoring the FET VDS and if so, the high pull-down current is used to turn off the ORing FET. In the event of a falling VIN transition in <1 $\mu$ s, (i.e., a catastrophic failure of the power source) the HSCOMP protects the common bus from the individual faulted power supply short by turning off the shorted supply's ORing MOSFET in less than 300ns, ensuring the integrity of the common bus voltage from reverse current to the damaged supply.

Once the correct  $V_{IN} > V_{OUT}$  relationship is established again, the ISL6146 again turns on the FET.

The FAULT pin is an open drain, active low output indicating that a fault or specific condition has occurred, these include:

- GATE is OFF ( $GATE < V_{IN} + 0.2V$ ). Lack of conduction, not a fault, just not on. ISL6146D and ISL6146E do not respond to this condition
- Faults resulting in  $V_{IN} - V_{OUT} > 0.57V$  when ON
- An open FET resulting in body diode conduction
- Excessive current through FET
- FET Faults monitored and reported include
  - G-D, gate unable to drive to Q-pump voltage
  - G-S, gate unable to drive to Q-pump voltage
  - D-S shorts, when GATE is OFF  $V_{DS} < 2V$
  - $V_{IN} < POR$
  - Missing  $V_{IN}$
  - $V_{IN}$  shorted to GND

On the ISL6146C version, a conditional fault is also signalled if the  $V_{IN}$  is not within the programmed UVLO and OVP levels.

The ISL6146 has an on-chip over-temperature fault threshold of  $\sim +140^{\circ}C$  with a  $20^{\circ}C$  hysteresis. Although the ISL6146 itself produces little heat, it senses the environment in which it is, likely including a close by FET.

The ISL6146A/D and ISL6146B/E are functional variants with an enabling input of either polarity. This feature is used when the need to interrupt the current path via signaling is necessary. This is accomplished by implementing two FETs in series so that there is a body diode positioned to block current in either direction. This functionality is considered an additional enhancement to the ORing diode it replaces.

The ISL6146C employs the use of a programmable Undervoltage Lock Out (UVLO) and a programmable Overvoltage Protection (OVP) input. This allows the GATE to only turn-on when the monitored voltage is between the programmed lower and upper levels. This application would use the back-to-back FET configuration. In the event that the current path does not need to be interrupted then the EN, UVLO and OVP inputs can all be overridden.

The ISL6146D and ISL6146E are variants of the ISL6146A and ISL6146B respectively, the difference being the former do not respond to a nonconduction condition (when enabled and  $V_{IN} > V_{OUT}$ , the GATE is not on) unlike the latter that do signal a fault.

## Applications Information

### Power-Up Considerations

#### BIAS AND $V_{IN}$ CONSTRAINTS

Upon power-up when the  $V_{IN}$  supply is separate from the BIAS supply, the BIAS voltage must be greater or equal to the  $V_{IN}$  voltage at all times.

When using a single supply for both the ISL6146 bias and the ORing supply, the  $V_{IN}$  and BIAS pins can be configured with a low value resistor between the two pins to provide some isolation and decoupling to support the chip bias even as the OR'd supply experiences voltage droops and surges. Although not necessary to do so, it is a best design practice for particularly noisy environments.

#### FET TO IC LAYOUT RECOMMENDATIONS

Connections from the FET(s) to the ISL6146  $V_{IN}$  and  $V_{OUT}$  pins must be Kelvin in nature and as close to the FET drain and source PCB pads as possible to eliminate any trace resistance errors that can occur with high currents. This connection placement is most critical to providing the most accurate voltage sensing particularly when the back-to-back FET configuration is used. Likewise, connections from OVP, UVLO and ADJ are also critical to optimize accuracy.

#### ADJUSTING THE HS COMPARATOR REVERSE VOLTAGE THRESHOLD

The ISL6146 allows adjustment of the HS Comparator reverse voltage detection threshold ( $V_{R\ Vth}$ ), the difference in  $V_{OUT} - V_{IN}$ .

There are two valid ADJ pin configurations:

1. ADJ connected to  $V_{OUT}$ : This makes the HS comparator threshold equal to the intrinsic error in the HS comparator input. This is the default condition and the most likely used configuration.
2. A single resistor is connected from ADJ pin to ground: Making the HS comparator threshold =  $V_{OUT} - 4k/R_{ADJ}$ .

So, for a  $100k\Omega$   $R_{EXT}$ , HS Comparator threshold = 40mV below  $V_{OUT}$  and for a  $5k\Omega$   $R_{EXT}$  HS comparator threshold =  $\sim 800mV$  below  $V_{OUT}$ .

The recommended resistor range is  $5k\Omega$  to  $100k\Omega$  for this voltage adjustment.

At power-up, the HS comparator threshold is default set to the internal device error first, and then released to the user programmed threshold after the related circuits are ready. It takes  $\sim 20\mu s$  for the circuit to switch from the default setting to the user programmed threshold after a POR startup.

The current out of the ADJ pin with a resistor to GND is equal to  $0.4V/R_{EXT}$ .

#### BACK-TO-BACK FET CONFIGURATION

When using the back-to-back FET configuration, the FET choice must be such that the voltage across both FETs at full current loading be less than the minimum forward voltage fault threshold of 400mV to avoid unintended fault notification.

In this configuration, it may be tempting to use the enable inputs to force a path by switching between the two as opposed to having both paths on, and having the higher voltage source provide current. The problem with that is the timing of the FETs on and off, so that excessive  $V_{OUT}$  voltage droop is not introduced if the turn-off happens faster, or before the (or a slower) turn-on momentarily leaves the load with an inadequate power connection.

### Typical Applications Circuits

There are four basic configurations that the ISL6146 can be used in:

1. For voltages  $>3V$  where the BIAS and  $V_{IN}$  are common
2. For a very low ORing voltage,  $<3V$  operation, BIAS  $>3V$
3. For a voltage window compliant operation and,
4. For a signaled operation where the current path is controlled by an input signal or minimum voltage condition.

Each of these configurations can be tailored for the High Speed Comparator (HS COMP) reverse threshold via the ADJ input being connected either to  $V_{OUT}$  or to GND via a resistor as previously explained. Additionally, the voltage window is adjustable for both a minimum and maximum operating voltage via the UVLO and OVP inputs and a resistor divider also explained earlier. Also, soft-start and turn-on and turn-off characteristics can be tailored to suit.

The three evaluation platforms provided demonstrate the four basic configurations and provide for the additional tailoring of the various performance characteristics.

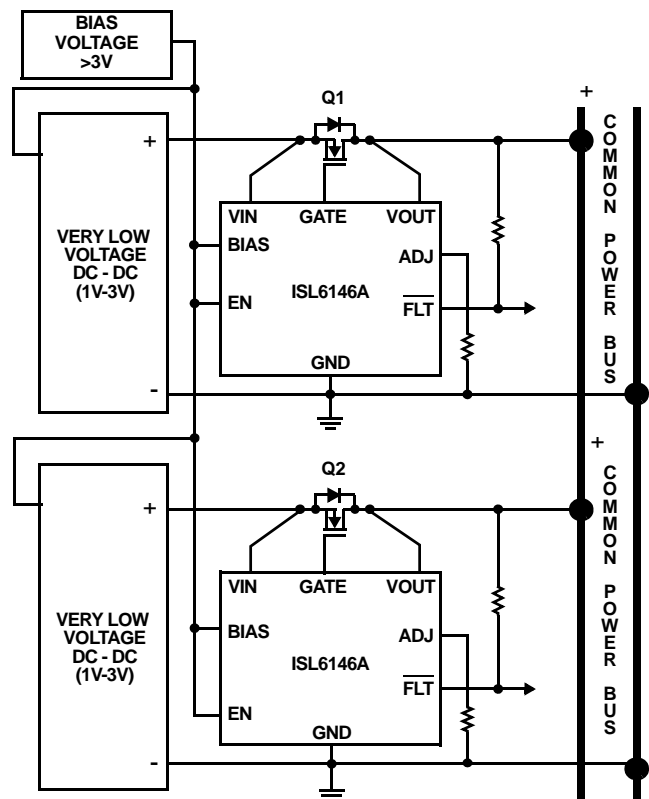

FIGURE 47. LOW VOLTAGE APPLICATION DIAGRAM

The Figure 1 circuit shown on page 1 is the basic circuit used for ORing voltages >3V to 20V.

The ISL6146A application shown in Figure 47 is the configuration for ORing very low voltages of 1V to 3V. Additionally, this application shows the utilization of the ADJ input with a single resistor tied to GND. This provides the user a programmable level of  $V_{OUT} > V_{IN}$  before the High Speed (HS) Comparator is activated and the GATE output is pulled down to allow for normal voltage fluctuations in the system.

Notice that in both of these circuits, the EN or  $\overline{EN}$  inputs are defaulted to enabled and have no current path on/off control. Failure to do so correctly will result in only body diode conduction and a resulting fault indication.

The  $V_{IN}$  and  $V_{OUT}$  to FET and GND to ADJ connections are drawn to emphasize the Kelvin connection necessary to correctly monitor the voltage across the FET, and for the VR  $V_{th}$  monitor to eliminate any stray resistance effects.

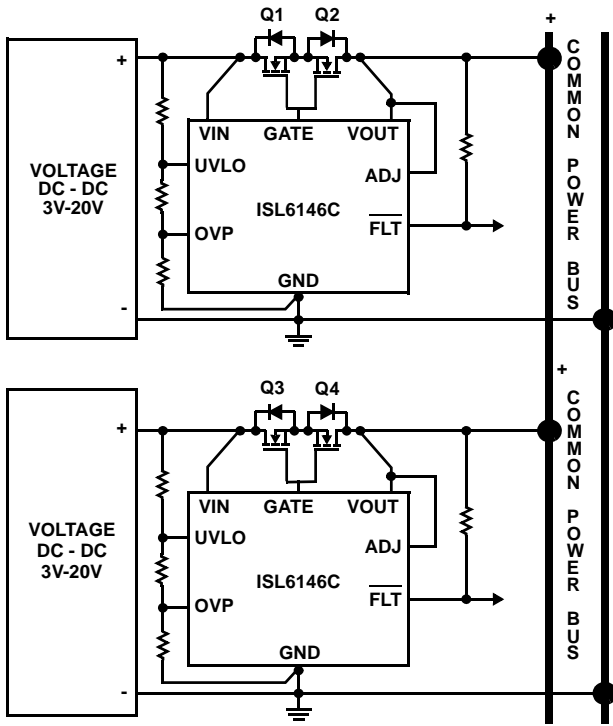

FIGURE 48. TYPICAL ISL6146C APPLICATION DIAGRAM

The ISL6146C application shown in Figure 48 is limited to the 3V to 20V  $V_{IN}$  range and must implement the back-to-back FET configuration to utilize the UVLO and OVP inputs and capabilities. As the  $V_{IN}$  voltage rises above the minimum programmed voltage, the related ORing FETs will turn on and stay on until either the minimum voltage requirement is no longer met or the  $V_{IN}$  voltage exceeds its programmed maximum. The minimum and maximum programmed voltage levels are done with the resistor divider on the UVLO and OVP pins. These levels should be programmed to take into account conduction path losses to the load in addition to the IC operational constraints.

When using the back-to-back FET configuration, the user must choose FETs to ensure  $(2r_{DS(ON)} + PCB IR) I_{LOAD} < 0.5V$  to avoid tripping the  $V_{IN} - V_{OUT} > 0.5V$  when ON fault.

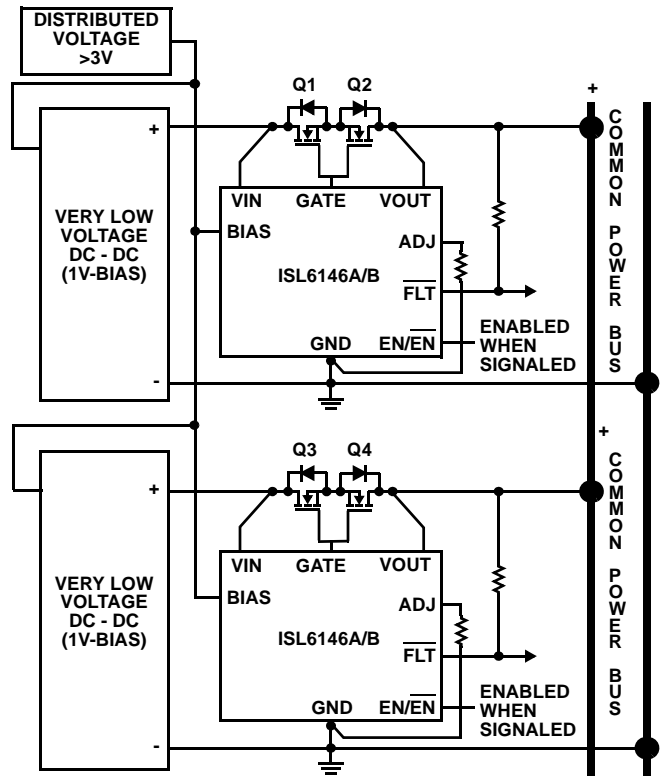

FIGURE 49. CONTROLLED ON/OFF APPLICATION DIAGRAM

The application diagram in Figure 49 shows the ISL6146A or ISL6146B utilizing the EN or  $\overline{EN}$  pin as a signalled input to open or close the conduction path from power supply to load. This feature can be implemented on ORing 1V to 20V but is shown for ORing <3V.

The enable input signaling can be simultaneous across the N+1 number of ISL6146s used.

Although not needed for thermal relief, connect the DFN EPAD to GND.

### SWITCH-OVER CIRCUITS

Switch over applications are different than ORing applications in that, the former are looking for the presence of or a condition of a preferred supply in order to switch to it. Whereas true ORing consists of a redundant N+1 configuration with no preferred source.

The following 2 circuits are simple single ISL6146 switchover circuits optimized for situations particular to the  $V_{BATT}$  and  $V_{EXT}$  voltages relative to each other. Figure 50 shows an ISL6146B switchover circuit where  $V_{EXT}$ , when present, is the preferred source and  $V_{BATT}$  could be lesser or greater than  $V_{EXT}$ . This circuit senses the presence of the preferred voltage supply to a programmable threshold level that when exceeded,  $V_{EXT}$  is passed to the output as  $V_{BATT}$  is disconnected from the output.

R1 & R2 program the  $V_{EXT}$  level that must be preset for the preferred voltage to be passed to the output.

Q3 is necessary if  $V_{BATT}$  can ever exceed  $V_{EXT}$  to prevent current from flowing into  $V_{EXT}$  when present. The body diode of Q3

# ISL6146

prevents that when Q1 is on regardless of the  $V_{BATT}$  voltage. The ISL6146 bias is pulled from the common drain node to ensure an always adequate bias from either source when the other is absent

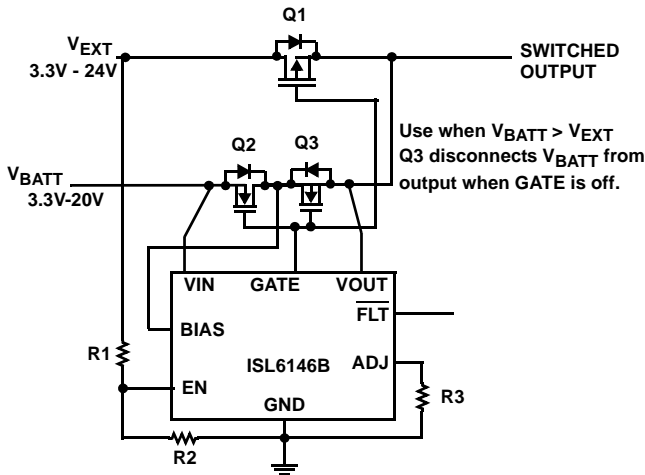

FIGURE 50. ISL6146B EXTERNAL SWITCHOVER SCHEMATIC

Figure 51 shows operational scope shots of the above circuit.

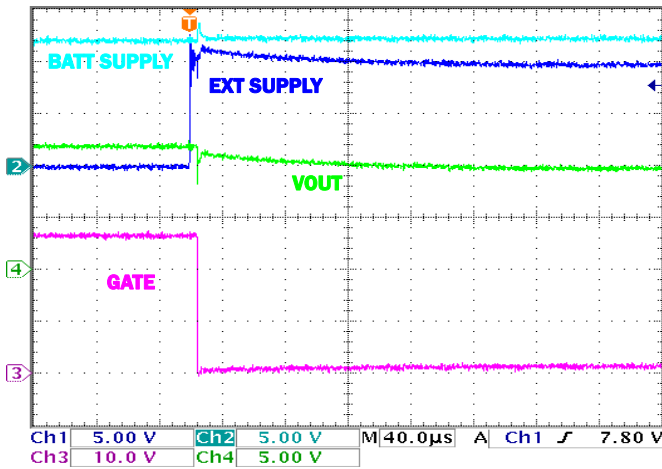

FIGURE 51. EXTERNAL SUPPLY < BATT SUPPLY CONNECTED

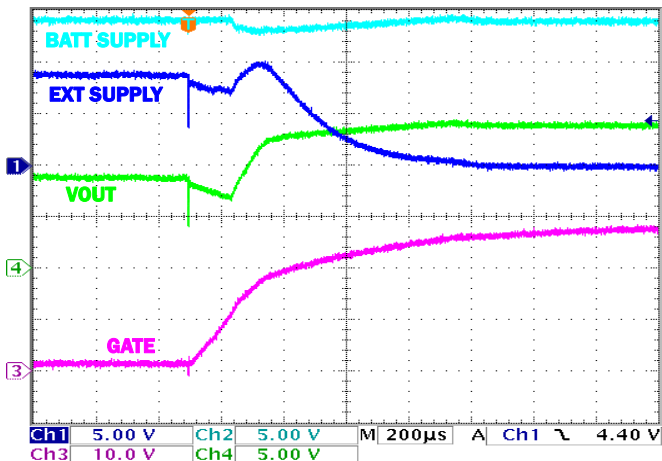

FIGURE 52. EXTERNAL SUPPLY < BATT SUPPLY DISCONNECTED

All of the scope shots were taken with a 5A load and 100µF of bulk load capacitance.

Figure 52 is a ISL6146A switchover circuit to use where the preferred  $V_{EXT}$  source is always greater than the  $V_{BATT}$ . Because this is so, there is no need for a 3rd FET for blocking as in Figure 50. Additionally, the preferred  $V_{EXT}$  source when present or at a programmed minimum threshold voltage via R1 and R2 divider will turn on Q2/turn-off Q1 but when absent or not minimally adequate, will do the opposite. In this circuit, with the ISL6146A not connected to the battery, and thus no constant  $I_{VIN}$  load on it, which allows for longer battery life.

Bias voltage is pulled from the common output to ensure an always adequate IC bias from either source.

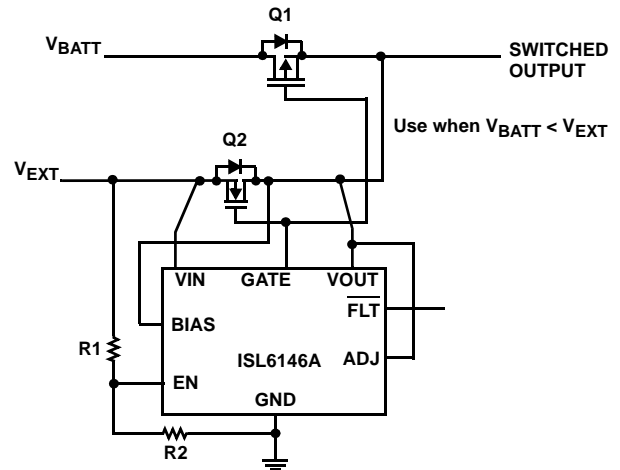

FIGURE 53. ISL6146A EXTERNAL SWITCHOVER SCHEMATIC

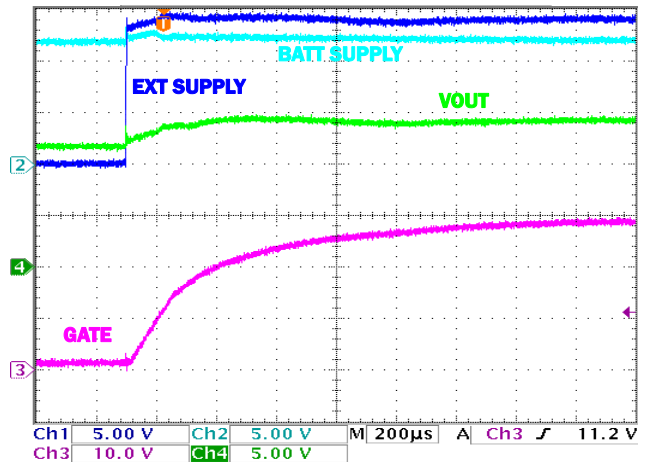

FIGURE 54. EXTERNAL SUPPLY > BATT SUPPLY CONNECTED



# ISL6146

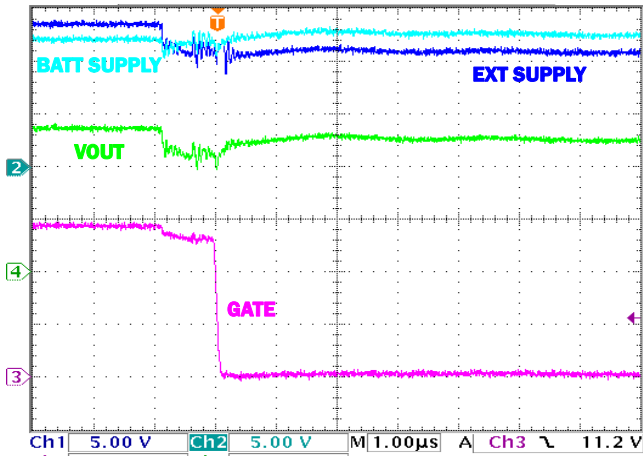

FIGURE 55. EXTERNAL SUPPLY > BATT SUPPLY DISCONNECTED

The ISL6146AEVAL1Z, ISL6146DEVAL1Z are configured to have a 8.5V minimum turn-on threshold with a 1.2V hysteresis.

The ISL6146BEVAL1Z, ISL6146EEVAL1Z are configured as a minimally featured maximum performance ORing FET controller for 3V to 20V.

The ISL6146CEVAL1Z is configured to operate with a 10.8V lower turn on threshold and 14.9V upper turn-off threshold.

All five boards are equipped with 50A capable FETs for high current evaluations and with a minimum of  $V_{IN}$  and  $V_{OUT}$  bulk capacitance likely to be found in any power system design.

After determining the BIAS source along with  $V_{IN}$  voltage criteria and configuring the evaluation board if necessary, for the application to be evaluated the board is ready for power.

Apply the BIAS voltage first (via the test points labeled BIAS), if separate from  $V_{IN}$ , then the  $V_{IN}$  voltage. Monitor the provided test points for device performance with current loads up to 50A.

Figures 56 through 61 illustrate the three ISL6146 evaluation boards for the three typical applications in photograph and schematic form.

## ISL6146 Evaluation Platforms

### Description and Use of the Evaluation Boards

The three ISL6146 evaluation boards are used to demonstrate the four application configurations discussed earlier. All the boards have ADJ shorted to  $V_{OUT}$  with the PCB layout having the component footprints to insert a resistor of choice between ADJ and GND to adjust the HS COMP  $V_{th}$ . Likewise, the  $V_{IN}$  is connected to BIAS but these can be separated to provide an adequate BIAS voltage when ORing <3V supplies or if providing a separate from  $V_{IN}$  voltage to BIAS.

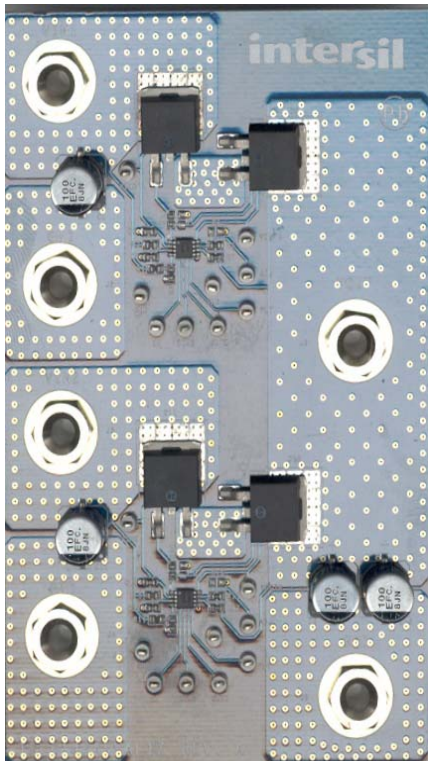

FIGURE 56. ISL6146AEVAL1Z, ISL6146DEVAL1Z PHOTOGRAPH

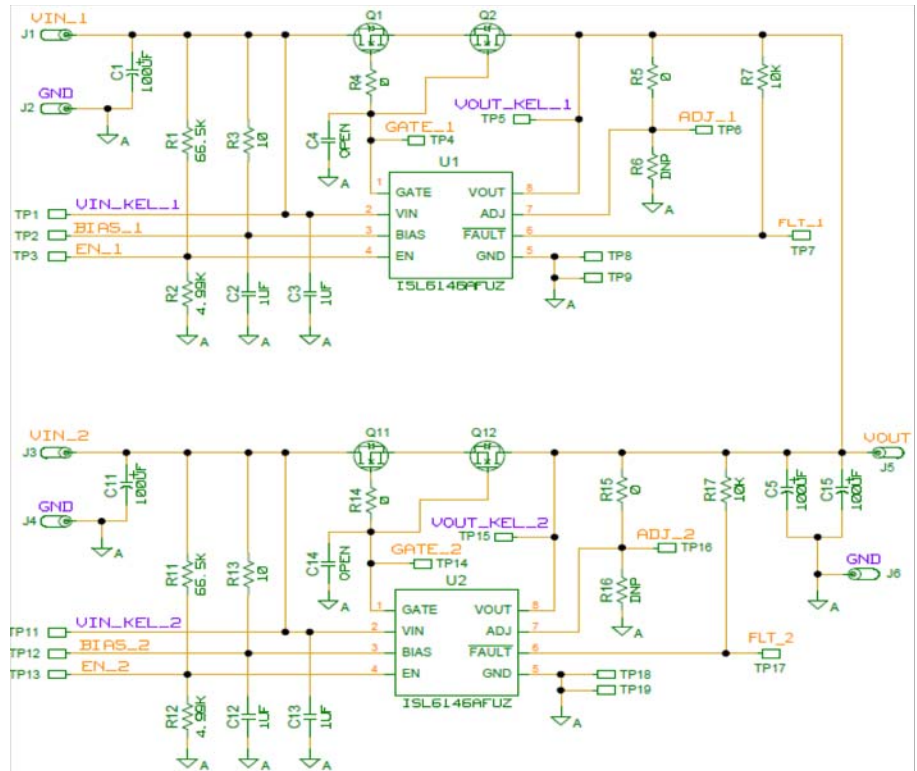

FIGURE 57. ISL6146AEVAL1Z, ISL6146DEVAL1Z SCHEMATIC

# ISL6146

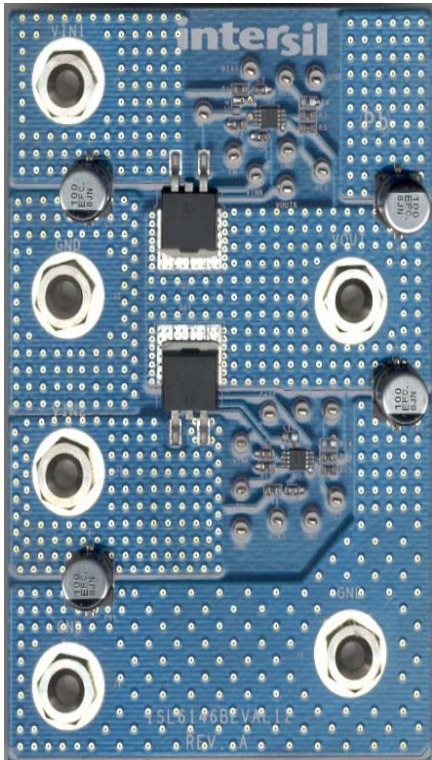

FIGURE 58. ISL6146BEVAL1Z, ISL6146EEVAL1Z PHOTOGRAPH

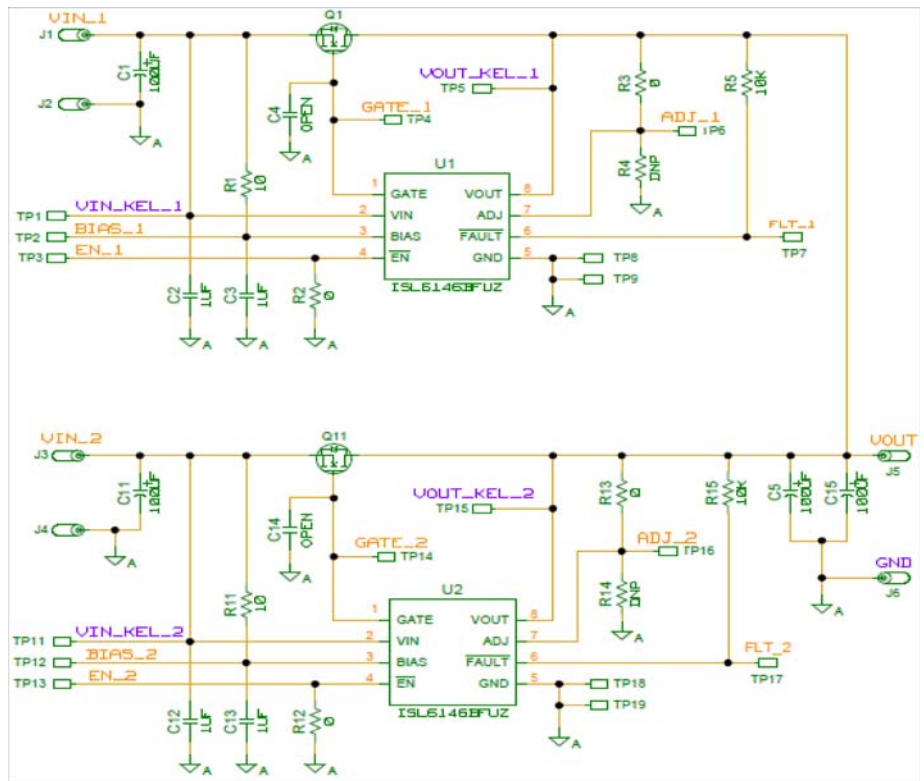

FIGURE 59. ISL6146BEVAL1Z, ISL6146EEVAL1Z SCHEMATIC

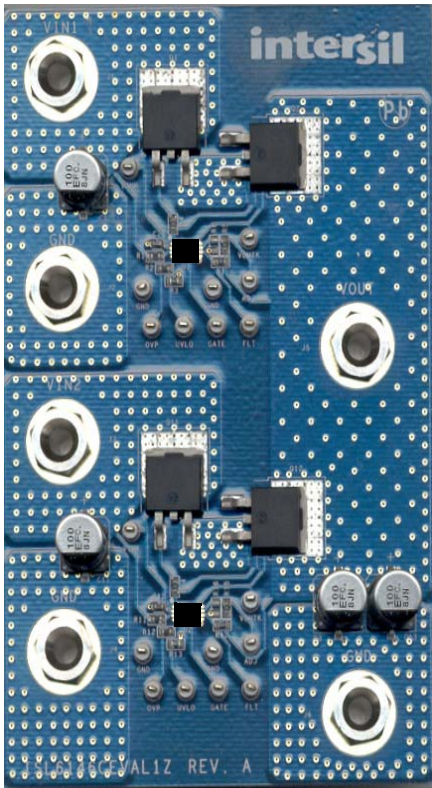

FIGURE 60. ISL6146CEVAL1Z PHOTOGRAPH

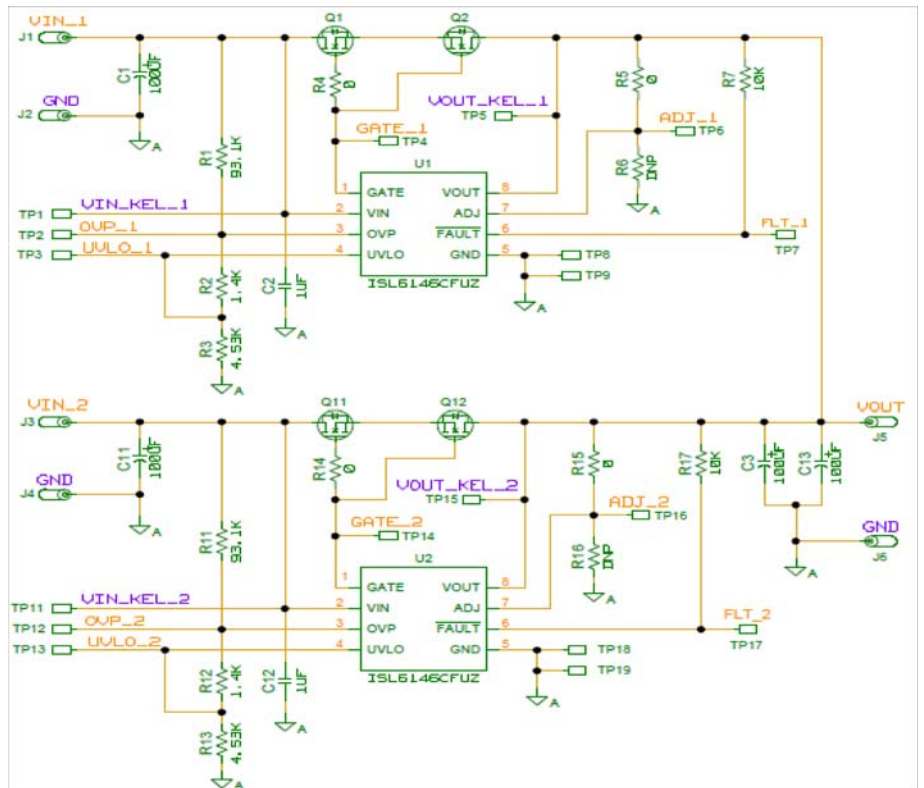

FIGURE 61. ISL6146CEVAL1Z SCHEMATIC (UVLO AND OVP TEST POINT LABELS ARE SWAPPED)

# ISL6146

TABLE 2. ISL6146xEVALZ BOM

REFERENCE DESIGNATOR	VALUE	DESCRIPTION	MANUFACTURER	PART NUMBER
<b>ISL6146AEVAL1Z</b>				
U1, U2		ISL6146A ORing FET Controller	Intersil	ISL6146AFUZ
Q1, Q2, Q11, Q12		30V, 50A FET	Various	
R1, 11	66.5k $\Omega$	RES, SMD, 0603, 1%	Generic	
R2, R12, R6, R16	4.99k $\Omega$	RES, SMD, 0603, 1%	Generic	
R3, R13	10 $\Omega$	RES, SMD, 0603, 1%	Generic	
R4, R14	0 $\Omega$	RES, SMD, 0603, 1%	Generic	
R5, R15	DNP	RES, SMD, 0603, 1%	Generic	
R7, R17	10k $\Omega$	RES, SMD, 0603, 1%	Generic	
C1, C11, C5 C15	100 $\mu$ F	Alum. Elect SMD Cap	Generic	
C2, C3, C12 C13	1 $\mu$ F	CAP, SMD, 0603, 50V, 10%	Generic	
C4, C14	DNP	CAP, SMD, 0603, 50V, 10%	Generic	
TPx		Test Point	Generic	
Jx		Banana Jack	Generic	
<b>ISL6146BEVAL1Z</b>				
U1, U2		ISL6146B ORing FET Controller	Intersil	ISL6146BFUZ
Q1, Q11		30V, 50A FET	Various	
R4, R14	4.99k $\Omega$	RES, SMD, 0603, 1%	Generic	
R1, R10	10 $\Omega$	RES, SMD, 0603, 1%	Generic	
R2, R12	0 $\Omega$	RES, SMD, 0603, 1%	Generic	
R3, R13	DNP	RES, SMD, 0603, 1%	Generic	
R5, R15	10k $\Omega$	RES, SMD, 0603, 1%	Generic	
C1, C11, C5 C15	100 $\mu$ F	ALum. Elect SMD Cap	Generic	
C2, C3, C12 C13	1 $\mu$ F	CAP, SMD, 0603, 50V, 10%	Generic	
C4, C14	DNP	CAP, SMD, 0603, 50V, 10%	Generic	
TPx		Test Point	Generic	
Jx		Banana Jack	Generic	
<b>ISL6146CEVAL1Z</b>				
U1, U2		ISL6146C ORing FET Controller	Intersil	ISL6146CFUZ
Q1, Q2, Q11, Q12		30V, 50A FET	Various	
R1, 11	93.1k $\Omega$	RES, SMD, 0603, 1%	Generic	
R2, R12	1.4k $\Omega$	RES, SMD, 0603, 1%	Generic	
R3, R13	4.53k $\Omega$	RES, SMD, 0603, 1%	Generic	
R4, R14	0 $\Omega$	RES, SMD, 0603, 1%	Generic	
R5, R15	DNP	RES, SMD, 0603, 1%	Generic	
R6, R16	4.99k $\Omega$	RES, SMD, 0603, 1%	Generic	
R7, R17	10k $\Omega$	RES, SMD, 0603, 1%	Generic	
C1, C11, C3 C13	100 $\mu$ F	ALum. Elect SMD Cap	Generic	
C2, C12	1 $\mu$ F	CAP, SMD, 0603, 50V, 10%	Generic	
TPx		Test Point	Generic	
Jx		Banana Jack	Generic	

# ISL6146

TABLE 2. ISL6146xEVALZ BOM (Continued)

REFERENCE DESIGNATOR	VALUE	DESCRIPTION	MANUFACTURER	PART NUMBER
<b>ISL6146DEVALZ</b>				
U1, U2		ISL6146D ORing FET Controller	Intersil	ISL6146DFUZ
Q1, Q2, Q11, Q12		30V, 50A FET	Various	
R1, R11	66.5k $\Omega$	RES, SMD, 0603, 1%	Generic	
R2, R12, R6, R16	4.99k $\Omega$	RES, SMD, 0603, 1%	Generic	
R3, R13	10 $\Omega$	RES, SMD, 0603, 1%	Generic	
R4, R14	0 $\Omega$	RES, SMD, 0603, 1%	Generic	
R5, R15	DNP	RES, SMD, 0603, 1%	Generic	
R7, R17	10k $\Omega$	RES, SMD, 0603, 1%	Generic	
C1, C11, C5 C15	100 $\mu$ F	Alum. Elect SMD Cap	Generic	
C2, C3, C12 C13	1 $\mu$ F	CAP, SMD, 0603, 50V, 10%	Generic	
C4, C14	DNP	CAP, SMD, 0603, 50V, 10%	Generic	
TPx		Test Point	Generic	
Jx		Banana Jack	Generic	
<b>ISL6146EEVALZ</b>				
U1, U2		ISL6146E ORing FET Controller	Intersil	ISL6146EFUZ
Q1, Q11		30V, 50A FET	Various	
R4, R14	4.99k $\Omega$	RES, SMD, 0603, 1%	Generic	
R1, R10	10 $\Omega$	RES, SMD, 0603, 1%	Generic	
R2, R12	0 $\Omega$	RES, SMD, 0603, 1%	Generic	
R3, R13	DNP	RES, SMD, 0603, 1%	Generic	
R5, R15	10k $\Omega$	RES, SMD, 0603, 1%	Generic	
C1, C11, C5 C15	100 $\mu$ F	ALum. Elect SMD Cap	Generic	
C2, C3, C12 C13	1 $\mu$ F	CAP, SMD, 0603, 50V, 10%	Generic	
C4, C14	DNP	CAP, SMD, 0603, 50V, 10%	Generic	
TPx		Test Point	Generic	
Jx		Banana Jack	Generic	



## Revision History

The revision history provided is for informational purposes only and is believed to be accurate, but not warranted. Please go to web to make sure you have the latest revision.

DATE	REVISION	CHANGE
September 27, 2012	FN7667.3	Added tape and reel parts to Ordering Information table for ISL6146A/B/C/D/E products. Thermal Information - removed Pb-Free Reflow link
June 18, 2012	FN7667.2	Added ISL6146D and ISL6146E. References to these products added throughout the datasheet. Added Figures 45 & 46 to illustrate the fault differences between ISL6146A/B and ISL6146D/E. Moved Figure 50 and revised the related text on page 20 before the evaluation board section. Added Figures 51 - 55 and related text on page 20 to page 21.
February 27, 2012	FN7667.1	Removed note "MSOP packaged parts to be released soon" from "Ordering Information" on page 3. Added Figures 42 & 43 on page 15.
December 16, 2011	FN7667.0	Initial Release

## Products

Intersil Corporation is a leader in the design and manufacture of high-performance analog semiconductors. The Company's products address some of the industry's fastest growing markets, such as, flat panel displays, cell phones, handheld products, and notebooks. Intersil's product families address power management and analog signal processing functions. Go to [www.intersil.com/products](http://www.intersil.com/products) for a complete list of Intersil product families.

For a complete listing of Applications, Related Documentation and Related Parts, please see the respective product information page. Also, please check the product information page to ensure that you have the most updated datasheet: [ISL6146](http://www.intersil.com/products)

To report errors or suggestions for this datasheet, please go to: [www.intersil.com/askourstaff](http://www.intersil.com/askourstaff)

FITs are available from our website at: <http://rel.intersil.com/reports/search.php>

For additional products, see [www.intersil.com/product\\_tree](http://www.intersil.com/product_tree)

Intersil products are manufactured, assembled and tested utilizing ISO9000 quality systems as noted in the quality certifications found at [www.intersil.com/design/quality](http://www.intersil.com/design/quality)

*Intersil products are sold by description only. Intersil Corporation reserves the right to make changes in circuit design, software and/or specifications at any time without notice. Accordingly, the reader is cautioned to verify that data sheets are current before placing orders. Information furnished by Intersil is believed to be accurate and reliable. However, no responsibility is assumed by Intersil or its subsidiaries for its use; nor for any infringements of patents or other rights of third parties which may result from its use. No license is granted by implication or otherwise under any patent or patent rights of Intersil or its subsidiaries.*

For information regarding Intersil Corporation and its products, see [www.intersil.com](http://www.intersil.com)

## Package Outline Drawing

### L8.3x3J

8 LEAD DUAL FLAT NO-LEAD PLASTIC PACKAGE

Rev 0 9/09

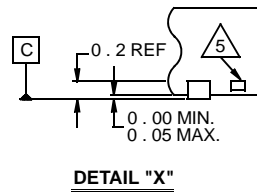
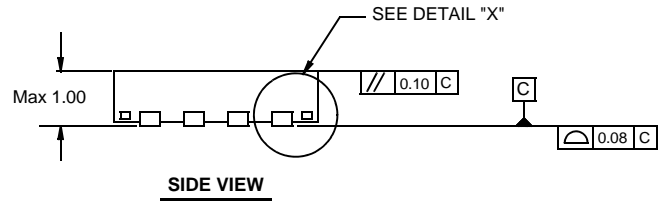
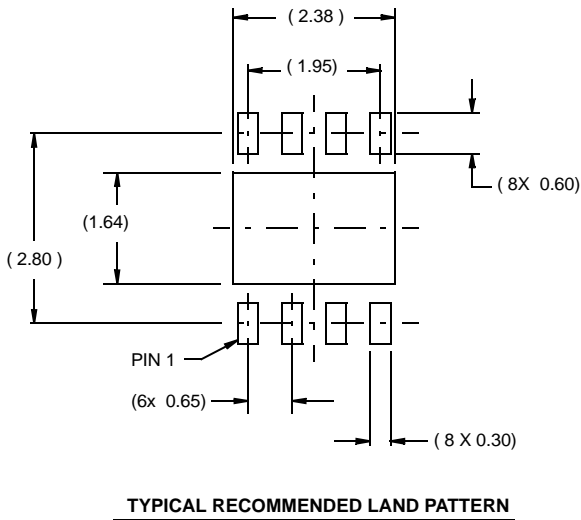
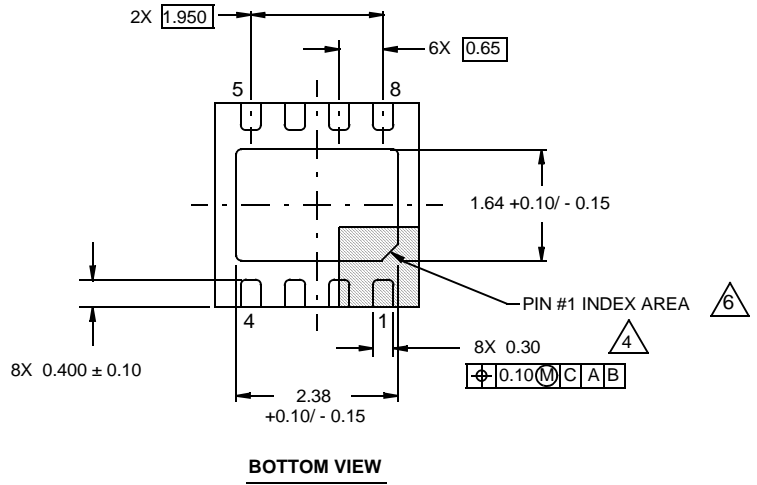
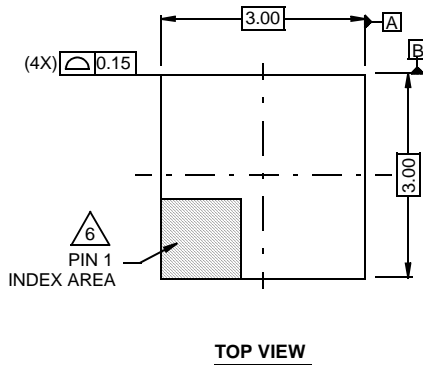

#### NOTES:

- Dimensions are in millimeters.  
Dimensions in ( ) for Reference Only.
- Dimensioning and tolerancing conform to AMSE Y14.5m-1994.
- Unless otherwise specified, tolerance : Decimal  $\pm 0.05$
- Dimension applies to the metallized terminal and is measured between 0.15mm and 0.30mm from the terminal tip.
- Tiebar shown (if present) is a non-functional feature.
- The configuration of the pin #1 identifier is optional, but must be located within the zone indicated. The pin #1 identifier may be either a mold or mark feature.

# Package Outline Drawing

## M8.118

8 LEAD MINI SMALL OUTLINE PLASTIC PACKAGE

Rev 4, 7/11

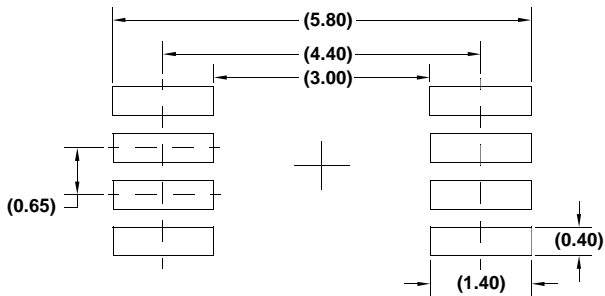
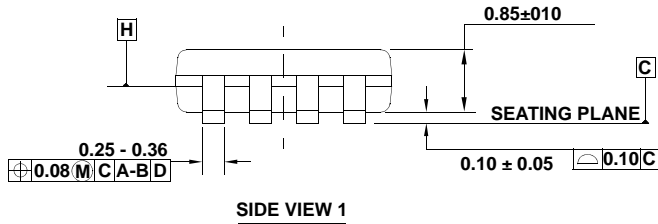
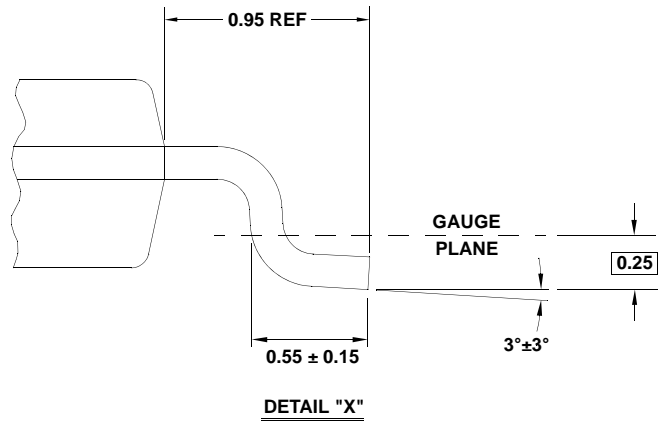
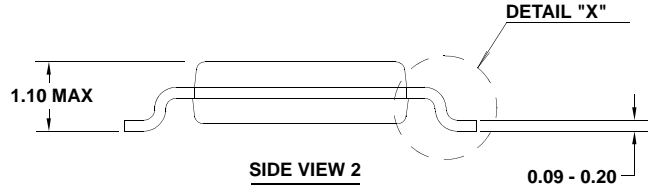
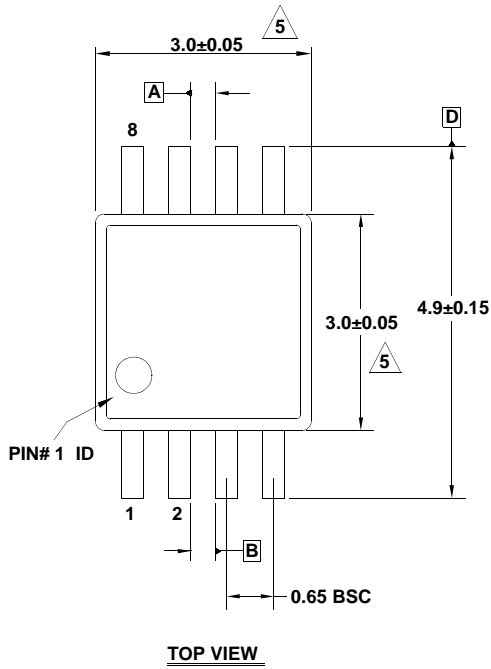

**NOTES:**

1. Dimensions are in millimeters.
2. Dimensioning and tolerancing conform to JEDEC MO-187-AA and AMSEY14.5m-1994.
3. Plastic or metal protrusions of 0.15mm max per side are not included.
4. Plastic interlead protrusions of 0.15mm max per side are not included.
5. Dimensions are measured at Datum Plane "H".
6. Dimensions in ( ) are for reference only.