

# Triple Analog Video Delay Lines

## ISL59920, ISL59921, ISL59922, ISL59923

The ISL59920, ISL59921, ISL59922, and ISL59923 are triple analog delay lines that provide skew compensation between three high-speed signals. These parts are ideal for compensating for the skew introduced by a typical CAT-5, CAT-6 or CAT-7 cable (with differing electrical lengths on each twisted pair) when transmitting analog video.

Using a simple serial interface, the ISL59920, ISL59921, ISL59922, and ISL59923's delays are programmable in steps of 2, 1.5, 1, or 2ns (respectively) for up to a total delay of 62, 46.5, 31, or 30ns (respectively) on each channel. The gain of the video amplifiers can be set to x1 (0dB) or x2 (6dB) for back-termination. The delay lines require a  $\pm 5V$  supply.

### Features

- 30, 31, 46.5, or 62ns Total delay
- 1.0, 1.5, or 2.0ns Delay step increments
- Very low offset voltage
- Drop-in compatible with the EL9115
- Low power consumption
- 20 Ld QFN package
- Pb-Free (RoHS compliant)

### Applications

- Skew control for RGB video signals
- Generating programmable high-speed analog delays

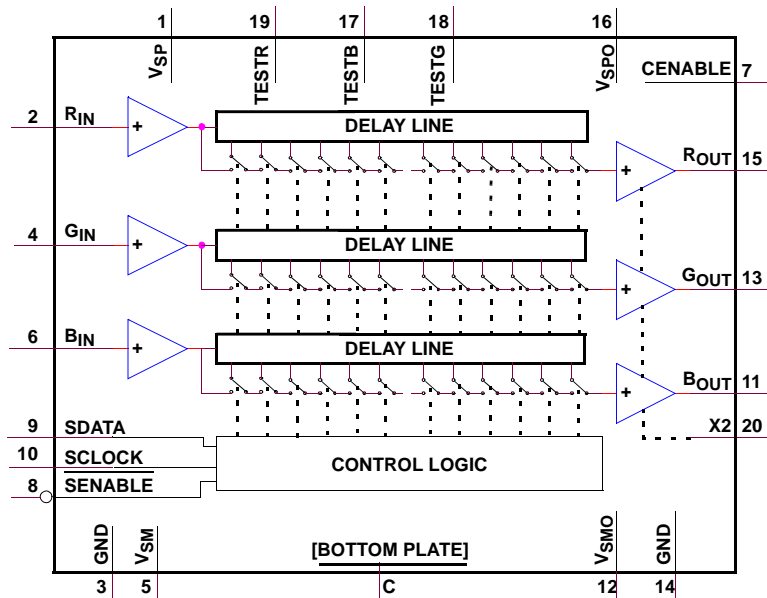

FIGURE 1. ISL59920, ISL59921, ISL59922, ISL59923 BLOCK DIAGRAM

# ISL59920, ISL59921, ISL59922, ISL59923

## Ordering Information

| PART NUMBER<br>(Notes 1, 2, 3) | PART MARKING | MAX DELAY<br>(ns) | DELAY STEP SIZE (ns) | TYPICAL POWER DISSIPATION<br>(mW) | PACKAGE<br>(Pb-free) | PKG. DWG. # |
|--------------------------------|--------------|-------------------|----------------------|-----------------------------------|----------------------|-------------|
| ISL59920IRZ                    | 59920 IRZ    | 62                | 2.0                  | 645                               | 20 Ld 5mmx5mm QFN    | L20.5x5C    |
| ISL59921IR                     | 59921 IRZ    | 46.5              | 1.5                  | 645                               | 20 Ld 5mmx5mm QFN    | L20.5x5C    |
| ISL59922IRZ                    | 59922 IRZ    | 31                | 1.0                  | 645                               | 20 Ld 5mmx5mm QFN    | L20.5x5C    |
| ISL59923IRZ                    | 59923 IRZ    | 30                | 2.0                  | 540                               | 20 Ld 5mmx5mm QFN    | L20.5x5C    |

### NOTES:

1. Add "-T\*" suffix for tape and reel. Please refer to TB347 for details on reel specifications.
2. These Intersil Pb-free plastic packaged products employ special Pb-free material sets, molding compounds/die attach materials, and 100% matte tin plate plus anneal (e3 termination finish, which is RoHS compliant and compatible with both SnPb and Pb-free soldering operations). Intersil Pb-free products are MSL classified at Pb-free peak reflow temperatures that meet or exceed the Pb-free requirements of IPC/JEDEC J STD-020.
3. For Moisture Sensitivity Level (MSL), please see product information pages for [ISL59920](#), [ISL59921](#), [ISL59922](#), [ISL59923](#). For more information on MSL, please see tech brief [TB363](#)

## Pin Configuration

ISL59920, ISL59921, ISL59922, ISL59923  
(20 LD 5x5 QFN)

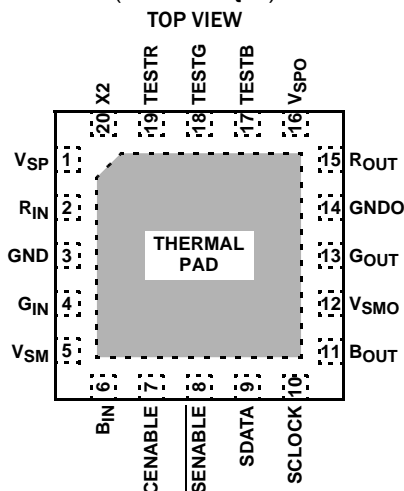

## Pin Descriptions

| PIN NUMBER | PIN NAME         | PIN DESCRIPTION   |
|------------|------------------|---|
| 1          | V <sub>SP</sub>  | +5V for delay circuitry and input amp   |
| 2          | R <sub>IN</sub>  | Red channel video input   |
| 3          | GND              | 0V for delay circuitry supply   |
| 4          | G <sub>IN</sub>  | Green channel video input   |
| 5          | V <sub>SM</sub>  | -5V for input amp   |
| 6          | B <sub>IN</sub>  | Blue channel video input  |
| 7          | CENABLE          | Chip Enable input, active high: logical high enables chip, low disables chip. This pin should be low at power-on until at least 30ms after the power supply has settled to within 5% of its final value. For more information, see <a href="#">"CENABLE at Power-On" on page 16</a> . |
| 8          | SENABLE          | Serial Enable input, active low: logical low enables serial communication   |
| 9          | SDATA            | Serial Data input, logic threshold 1.2V: data to be programmed into chip  |
| 10         | SCLOCK           | Serial Clock input: Clock to enter data; logical; data written on negative edge   |
| 11         | B <sub>OUT</sub> | Blue channel video output   |

# ISL59920, ISL59921, ISL59922, ISL59923

## Pin Descriptions (Continued)

| PIN NUMBER | PIN NAME         | PIN DESCRIPTION   |
|------------|------------------|---|
| 12         | V <sub>SMO</sub> | -5V for video output buffers  |
| 13         | G <sub>OUT</sub> | Green channel video output  |
| 14         | G <sub>NDO</sub> | 0V reference for input and output buffers   |
| 15         | R <sub>OUT</sub> | Red channel video output  |
| 16         | V <sub>SPO</sub> | +5V for video output buffers  |
| 17         | TESTB            | Blue channel phase detector output  |
| 18         | TESTG            | Green channel phase detector output   |
| 19         | TESTR            | Red channel phase detector output   |
| 20         | X2               | Gain Select Input: logical high = 2x (+6dB), logical low = 1x (0dB)   |
|            | Thermal Pad      | MUST be tied to -5V. For best thermal conductivity, tie to a larger -5V copper plane (inner or bottom). Use many vias to minimize thermal resistance between thermal pad and copper plane. Do not connect to GND - connection to GND is equivalent to shorting the -5V and GND planes together. |

# ISL59920, ISL59921, ISL59922, ISL59923

## Absolute Maximum Ratings (T<sub>A</sub> = +25°C)

|  |                 |
|--|-----------------|
| Supply Voltage (V <sub>S+</sub> to V <sub>S-</sub> ) | 12V             |
| Maximum Output Current                               | ±60mA           |
| Storage Temperature Range                            | -65°C to +150°C |
| ESD Classification                                   |                 |
| Human Body Model                                     | 3000V           |
| Machine Model  | 300V            |
| Charged Device Model                                 | 1200V           |

## Thermal Information

|                              |                           |                        |
|------------------------------|---------------------------|------------------------|
| Thermal Resistance (Typical) | θ <sub>JA</sub> (°C/W)    | θ <sub>JC</sub> (°C/W) |
| 20 Lead QFN (Notes 4, 5)     | 31                        | 2                      |
| Pb-Free Reflow Profile       | see <a href="#">TB493</a> |                        |

## Recommended Operating Conditions

|                                |                |
|--------------------------------|----------------|
| Operating Junction Temperature | +135°C         |
| Ambient Operating Temperature  | -40°C to +85°C |

CAUTION: Do not operate at or near the maximum ratings listed for extended periods of time. Exposure to such conditions may adversely impact product reliability and result in failures not covered by warranty.

### NOTE:

- θ<sub>JA</sub> is measured in free air with the component mounted on a high effective thermal conductivity test board with “direct attach” features. See Tech Brief [TB379](#).
- For θ<sub>JC</sub>, the “case temp” location is the center of the exposed metal pad on the package underside.

**Electrical Specifications** V<sub>SP</sub> = V<sub>SP0</sub> = +5V, V<sub>SM</sub> = V<sub>SMP</sub> = -5V, GAIN = 2, T<sub>A</sub> = +25°C, exposed die plate = -5V, x2 = 5V, R<sub>LOAD</sub> = 150Ω on all video outputs, unless otherwise specified.

| PARAMETER         | DESCRIPTION   | TEST CONDITIONS   | MIN (Note 6) | TYP  | MAX (Note 6) | UNITS |
|-------------------|---|---|--------------|------|--------------|-------|
| d <sub>t</sub>    | Nominal Delay Increment (Note 7)  | ISL59920  | 1.8          | 2    | 2.2          | ns    |
|                   |   | ISL59921  | 1.4          | 1.5  | 1.7          | ns    |
|                   |   | ISL59922  | 0.9          | 1    | 1.2          | ns    |
|                   |   | ISL59923  | 1.8          | 2    | 2.3          | ns    |
| t <sub>MAX</sub>  | Maximum Delay   | ISL59920  | 55           | 62   | 68           | ns    |
|                   |   | ISL59921  | 42.5         | 46.5 | 53.5         | ns    |
|                   |   | ISL59922  | 26.5         | 31   | 38.5         | ns    |
|                   |   | ISL59923  | 26.5         | 30   | 34.5         | ns    |
| D <sub>ELDT</sub> | Delay Difference Between Channels for Same Delay Settings On All Channels |   |              | 1    |              | ns    |
| t <sub>PD</sub>   | Propagation Delay   | ISL59920, ISL59923, measured input to output, delay setting = 0ns |              | 10   |              | ns    |
|                   |   | ISL59921, measured input to output, delay setting = 0ns           |              | 8    |              | ns    |
|                   |   | ISL59922, measured input to output, delay setting = 0ns           |              | 7    |              | ns    |
| BW -3dB           | 3dB Bandwidth, 0ns Delay Time   | ISL59920, ISL59923  |              | 153  |              | MHz   |
|                   |   | ISL59921  |              | 200  |              | MHz   |
|                   |   | ISL59922  |              | 230  |              | MHz   |
| BW ±0.1dB         | ±0.1dB Bandwidth, 0ns Delay Time  | ISL59920, ISL59923  |              | 50   |              | MHz   |
|                   |   | ISL59921  |              | 60   |              | MHz   |
|                   |   | ISL59922  |              | 50   |              | MHz   |
| SR                | Slew Rate   | ISL59920, 20 to 80, delay = 0ns                                   |              | 550  |              | V/μs  |
|                   |   | ISL59921, 20 to 80, delay = 0ns                                   |              | 640  |              | V/μs  |
|                   |   | ISL59922, 20 to 80, delay = 0ns                                   |              | 700  |              | V/μs  |
|                   |   | ISL59923; 20 to 80, delay = 0ns                                   |              | 550  |              | V/μs  |

# ISL59920, ISL59921, ISL59922, ISL59923

**Electrical Specifications**  $V_{SP} = V_{SP0} = +5V$ ,  $V_{SM} = V_{SMP} = -5V$ , GAIN = 2,  $T_A = +25^\circ C$ , exposed die plate = -5V, x2 = 5V,  $R_{LOAD} = 150\Omega$  on all video outputs, unless otherwise specified. (Continued)

| PARAMETER        | DESCRIPTION   | TEST CONDITIONS  | MIN<br>(Note 6) | TYP  | MAX<br>(Note 6) | UNITS             |
|------------------|---|--|-----------------|------|-----------------|-------------------|
| $t_R - t_F$      | Transient Response Time                                 | ISL59920, 20% to 80%, for any delay, 1V step delay = 0ns               |                 | 1.7  |                 | ns                |
|                  |   | ISL59921, 20% to 80%, for any delay, 1V step delay = 0ns               |                 | 1.6  |                 | ns                |
|                  |   | ISL59922, 20% to 80%, for any delay, 1V step delay = 0ns               |                 | 1.43 |                 | ns                |
|                  |   | ISL59923, 20% to 80%, for any delay, 1V step delay = 0ns               |                 | 1.7  |                 | ns                |
| $V_{OVER}$       | Voltage Overshoot                                       | For any delay, response to 1V step input                               |                 | 4    |                 | %                 |
| Settling Time    | Output Settling after Delay Change / Offset Calibration | Output settling time from rising edge of $\overline{SENABLE}$          |                 | 3    |                 | $\mu s$           |
| THD              | Total Harmonic Distortion                               | 1V <sub>p,p</sub> 10MHz sinewave, offset by +0.2V at mid delay setting |                 | -43  | -38             | dB                |
| X                | Crosstalk   | Stimulate G, measure R/B at 1MHz, ISL59920, ISL59921, ISL59923         |                 | -80  | -63             | dB                |
|                  |   | ISL59922   |                 | -78  | -59             | dB                |
| $V_N$            | Output Noise  | Bandwidth = 150MHz   |                 | 2    |                 | mV <sub>RMS</sub> |
| $G_0$            | Gain Zero Delay   |  | 1.74            | 1.8  | 1.92            | V/V               |
| $G_m$            | Gain Mid Delay  |  | 1.67            | 1.8  | 1.97            | V/V               |
| $G_f$            | Gain Full Delay   |  | 1.6             | 1.8  | 2               | V/V               |
| DG <sub>m0</sub> | Difference in Gain, 0 to Mid                            |  | -8              | 0.6  | 7.5             | %                 |
| DG <sub>f0</sub> | Difference in Gain, 0 to Full                           |  | -12             | -1.8 | 10              | %                 |
| DG <sub>fm</sub> | Difference in Gain, Mid to Full                         |  | -10             | -1.7 | 7.5             | %                 |
| $V_{IN}$         | Input Voltage Range                                     | ISL59920, Gain remains > 90% of nominal, Gain = 2                      | -0.7            |      | 1.1             | V                 |
|                  |   | ISL59921, Gain remains > 90% of nominal, Gain = 2                      | -0.7            |      | 1.04            | V                 |
|                  |   | ISL59922, Gain remains > 90% of nominal, Gain = 2                      | -0.7            |      | 1.04            | V                 |
|                  |   | ISL59923, Gain remains > 90% of nominal, Gain = 2                      | -0.7            |      | 1.15            | V                 |
| $I_B$            | $R_{IN}$ , $G_{IN}$ , $B_{IN}$ Input Bias Current       | ISL59920, ISL59921   | 3               | 6    | 8               | $\mu A$           |
|                  |   | ISL59922, ISL59923   | 1.5             |      | 8               | $\mu A$           |
| $V_{OS}$         | Output Offset Voltage                                   | Post offset calibration (Note 9), Delay = 0ns and Delay = Full         | -25             | -4   | +20             | mV                |
| $Z_{OUT}$        | Output Impedance  | ISL59920, ISL59921, Enabled, Chip enable = 5V                          | 4.5             | 5.4  | 6.3             | $\Omega$          |
|                  |   | ISL59922, ISL59923, Enabled, Chip enable = 5V                          | 3.5             |      | 6.3             | $\Omega$          |
|                  |   | Disabled, Chip enable = 0V   |                 | 8    |                 | M $\Omega$        |
| +PSRR            | Rejection of Positive Supply                            |  |                 | -42  | -29             | dB                |
| -PSRR            | Rejection of Negative Supply                            |  |                 | -58  | -46             | dB                |
| $I_{OUT}$        | Output Drive Current                                    | 10 $\Omega$ load, 0.5V drive   | 43              | 53   | 70              | mA                |
| $V_{IH}$         | Logic High  | Switch high threshold  |                 |      | 1.6             | V                 |
| $V_{IL}$         | Logic Low   | Switch low threshold   | 0.8             |      |                 | V                 |

# ISL59920, ISL59921, ISL59922, ISL59923

**Electrical Specifications**  $V_{SP} = V_{SP0} = +5V$ ,  $V_{SM} = V_{SMP} = -5V$ , GAIN = 2,  $T_A = +25^\circ C$ , exposed die plate = -5V,  $x2 = 5V$ ,  $R_{LOAD} = 150\Omega$  on all video outputs, unless otherwise specified. (Continued)

| PARAMETER                               | DESCRIPTION  | TEST CONDITIONS   | MIN<br>(Note 6) | TYP | MAX<br>(Note 6) | UNITS   |
|---|--|---|-----------------|-----|-----------------|---------|
| <b>POWER SUPPLY CHARACTERISTICS</b>     |  |   |                 |     |                 |         |
| V+                                      | $V_{SP}$ , $V_{SP0}$ Positive Supply Range   |   | +4.5            |     | +5.5            | V       |
| V-                                      | $V_{SM}$ , $V_{SM0}$ Negative Supply Range   |   | -4.5            |     | -5.5            | V       |
| $I_{SP}$                                | Positive Supply Current (Note 8)   | ISL59920  | 98              | 115 | 127             | mA      |
|   |  | ISL59921, ISL59922  | 98              | 125 | 146             | mA      |
|   |  | ISL59923  | 74              | 90  | 106             | mA      |
| $I_{SP0}$                               | Positive Output Supply Current (Note 8)  | ISL59920  | 11.3            | 13  | 15.3            | mA      |
|   |  | ISL59921, ISL59922  | 11.3            | 13  | 16.3            | mA      |
|   |  | ISL59923  | 9.9             | 13  | 16              | mA      |
| $I_{SM}$                                | Negative Supply Current (Note 8)   |   | -35.45          | -31 | -26             | mA      |
| $I_{SM0}$                               | Negative Output Supply Current (Note 8)  | ISL59920, ISL59921, ISL59922  | -15.5           | -13 | -11             | mA      |
|   |  | ISL59923  | -17.5           | -13 | -9.5            | mA      |
| $\Delta I_{SP}$                         | Supply Current (Note 8)  | Increase in $I_{SP}$ per unit step in delay per channel   |                 | 0.9 |                 | mA      |
| $I_{STANDBY}$                           | Positive Supply Standby Current (Note 8)   | Chip enable = 0V  |                 | 2.6 |                 | mA      |
| <b>SERIAL INTERFACE CHARACTERISTICS</b> |  |   |                 |     |                 |         |
| $t_{MAX}$                               | Max SCLOCK Frequency   | Maximum programming clock speed   |                 |     | 10              | MHz     |
| $t_{SEN\_SETUP}$                        | $\overline{SENABLE}$ to SCLOCK falling edge setup time. (see Figure 35).   | $\overline{SENABLE}$ falling edge should occur at least $t_{SEN\_SETUP}$ ns after previous (ignored) clock and $t_{SEN\_SETUP}$ before next (desired) clock. Clock edges occurring within $t_{en\_ck}$ of the $\overline{SENABLE}$ falling edge will have indeterminate effect. |                 | 10  |                 | ns      |
| $t_{SEN\_CYCLE}$                        | Minimum Separation Between $\overline{SENABLE}$ rising edge and next $\overline{SENABLE}$ falling edge. (see Figure 35). | If $\overline{SENABLE}$ is taken low less than $3\mu s$ after it was taken high, there is a small possibility that an offset correction will not be initiated.  | 3               |     |                 | $\mu s$ |

**NOTES:**

- Compliance to datasheet limits is assured by one or more methods: production test, characterization and/or design.
- The limits for the "Nominal Delay Increment" are derived by taking the limits for the "Maximum Delay" and dividing by the number of steps for the device. For the ISL59920, ISL59921, and ISL59922 the number of steps is 31; for the ISL59923 the number of steps is 15.
- All supply currents measured with Delay R = 0ns, G = mid delay, B = full delay.
- Offset measurements are referred to  $75\Omega$  load as shown in Figure 2.

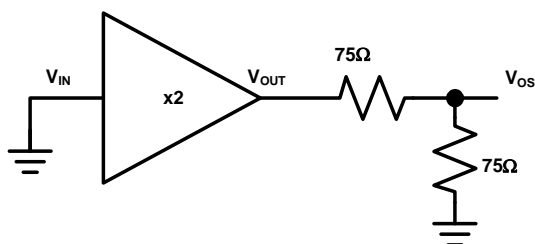

FIGURE 2.  $V_{0S}$  MEASUREMENT CONDITIONS

## Typical Performance Curves

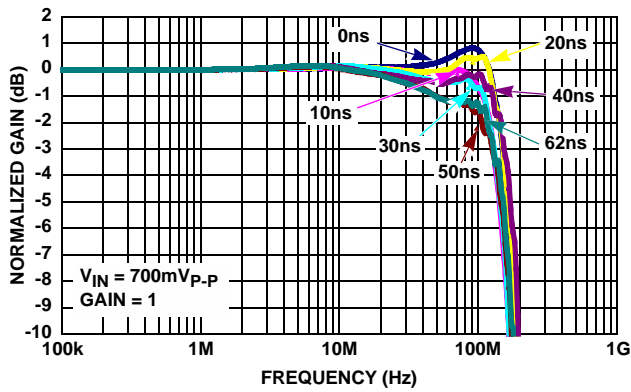

FIGURE 3. ISL59920 FREQUENCY RESPONSE (GAIN = 1)

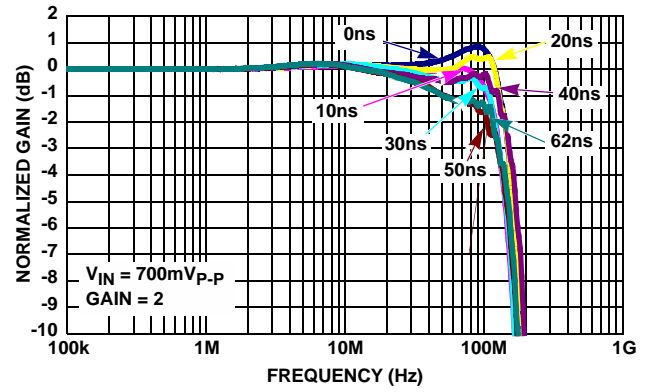

FIGURE 4. ISL59920 FREQUENCY RESPONSE (GAIN = 2)

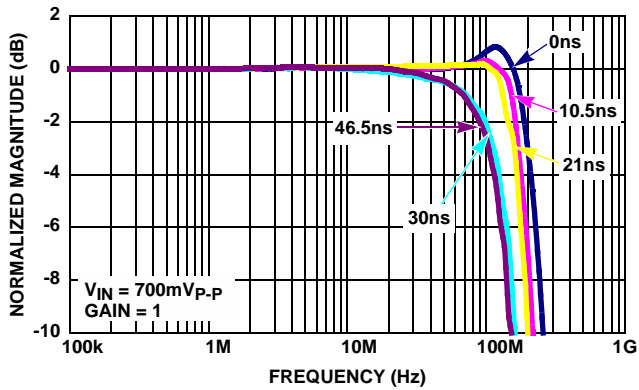

FIGURE 5. ISL59921 FREQUENCY RESPONSE (GAIN = 1)

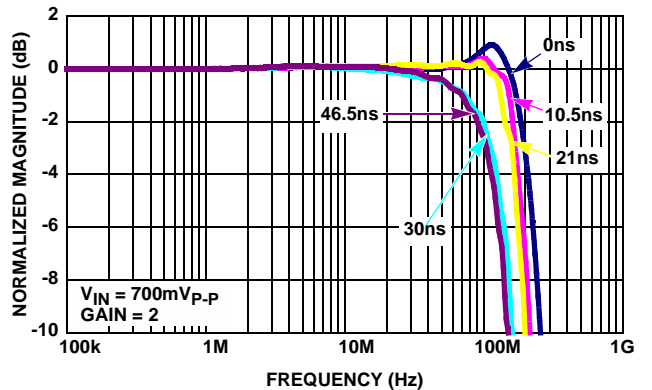

FIGURE 6. ISL59921 FREQUENCY RESPONSE (GAIN = 2)

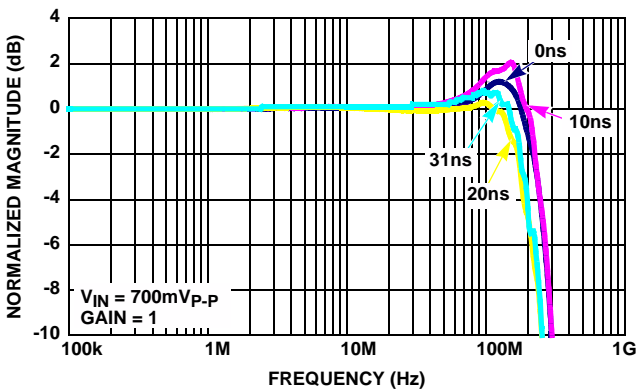

FIGURE 7. ISL59922 FREQUENCY RESPONSE (GAIN = 1)

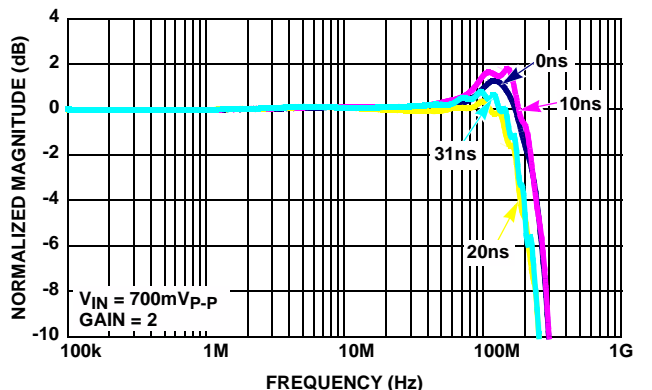

FIGURE 8. ISL59922 FREQUENCY RESPONSE (GAIN = 2)

## Typical Performance Curves (Continued)

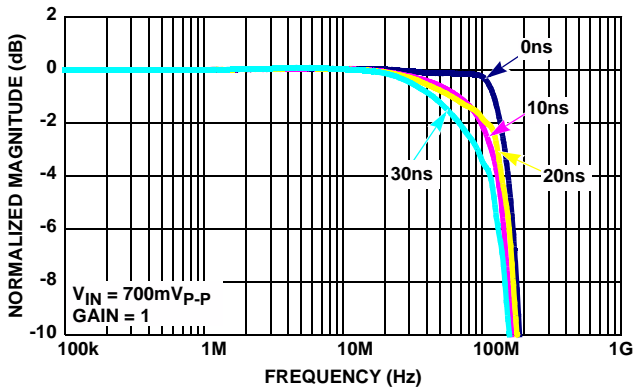

FIGURE 9. ISL59923 FREQUENCY RESPONSE (GAIN = 1)

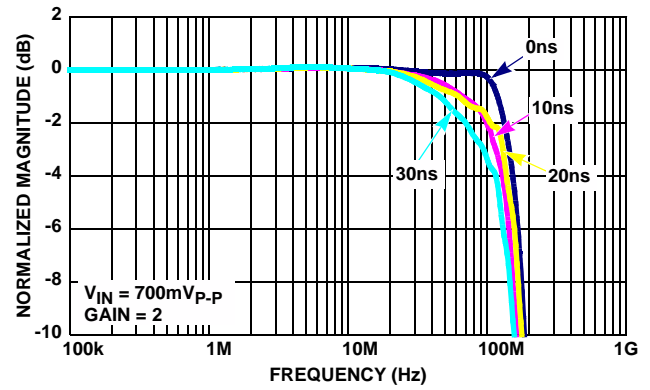

FIGURE 10. ISL59923 FREQUENCY RESPONSE (GAIN = 2)

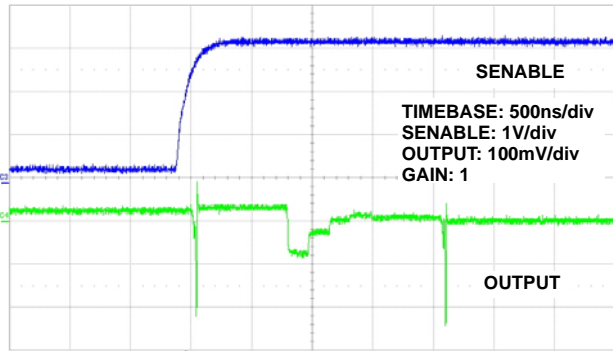

FIGURE 11. OFFSET CORRECTION DAC ADJUST

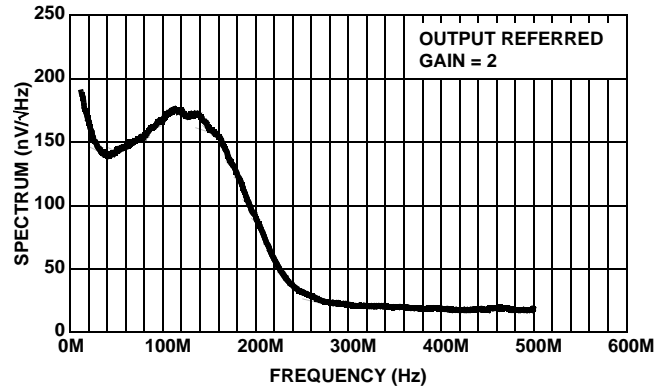

FIGURE 12. ISL59920 NOISE SPECTRUM (10k TO 500MHz)

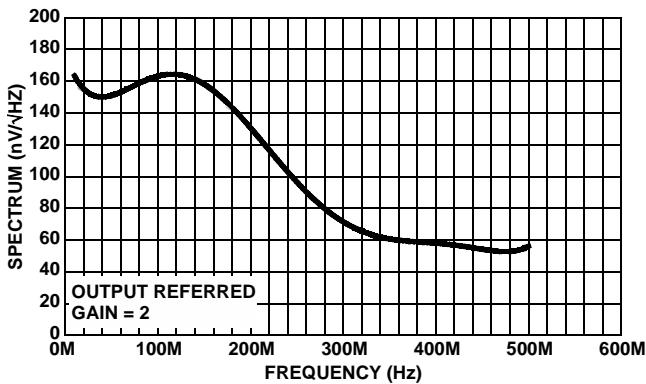

FIGURE 13. ISL59921 NOISE SPECTRUM (10k TO 500MHz)

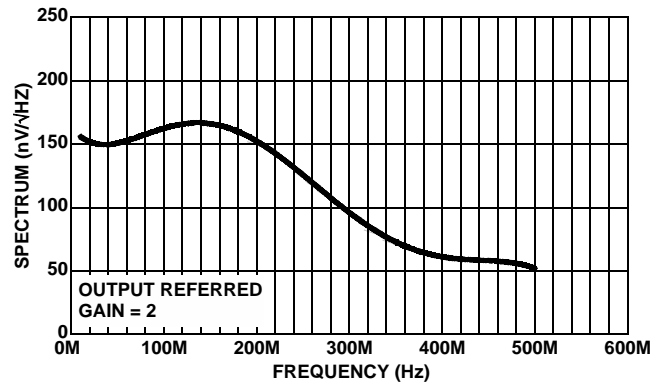

FIGURE 14. ISL59922 NOISE SPECTRUM (10k TO 500MHz)



## Typical Performance Curves (Continued)

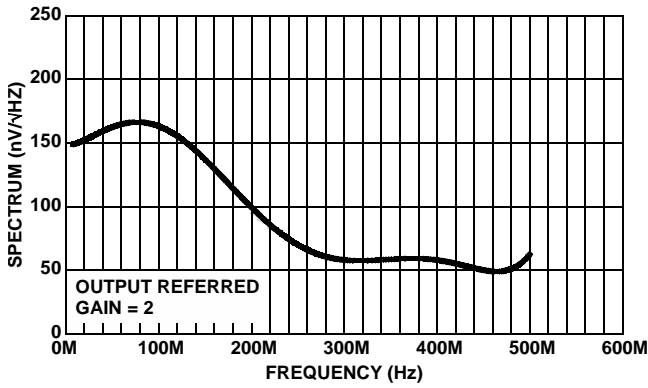

FIGURE 15. ISL59923 NOISE SPECTRUM (10k TO 500MHz)

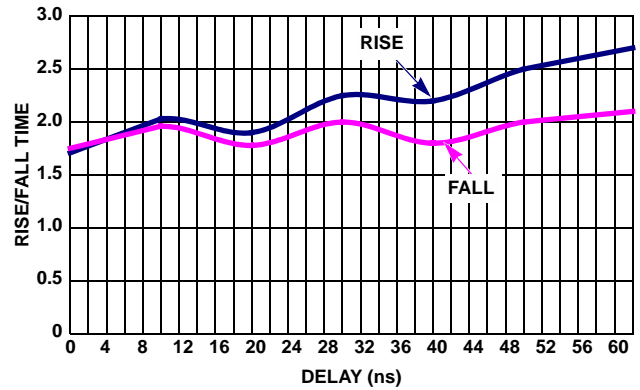

FIGURE 16. ISL59920 RISE/FALL TIME vs DELAY TIME (GAIN = 2)

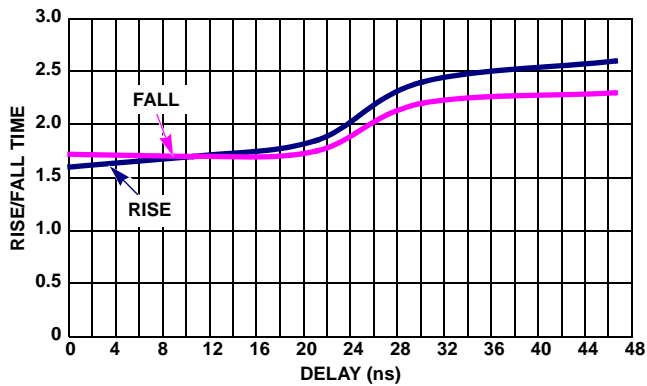

FIGURE 17. ISL59921 RISE/FALL TIME vs DELAY TIME (GAIN = 2)

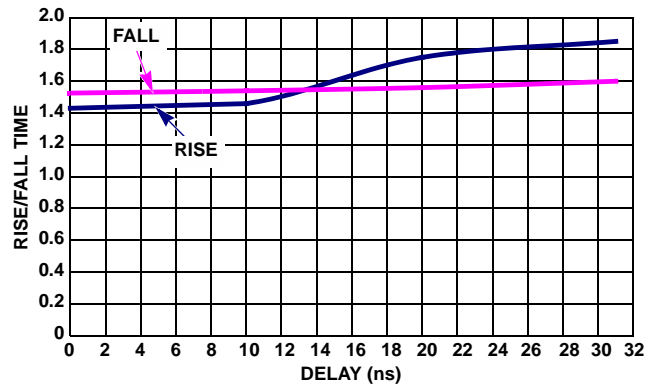

FIGURE 18. ISL59922 RISE/FALL TIME vs DELAY TIME (GAIN = 2)

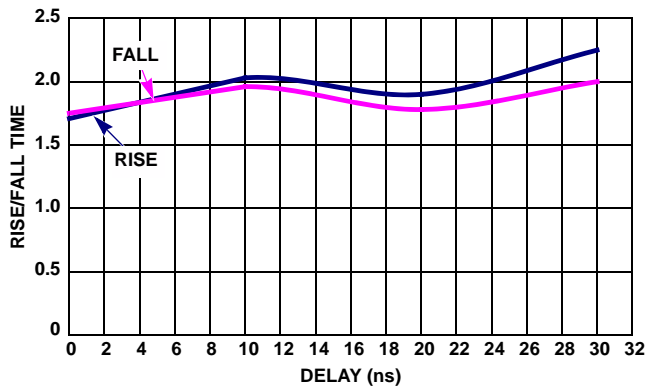

FIGURE 19. ISL59923 RISE/FALL TIME vs DELAY TIME (GAIN = 2)

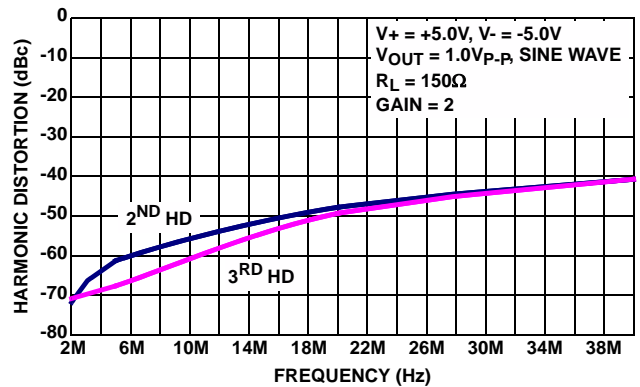

FIGURE 20. HARMONIC DISTORTION vs FREQUENCY

## Typical Performance Curves (Continued)

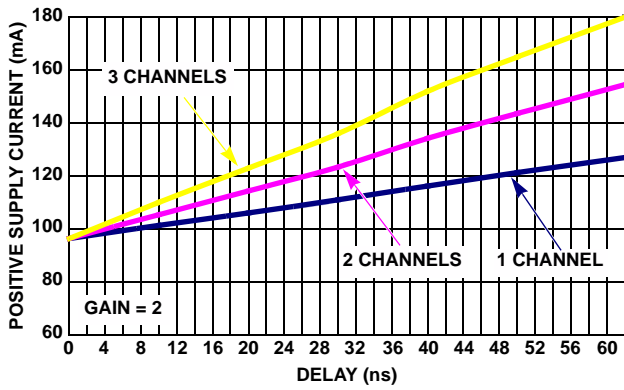

FIGURE 21. ISL59920 POSITIVE SUPPLY CURRENT ( $V_{SP}$ ) vs DELAY TIME

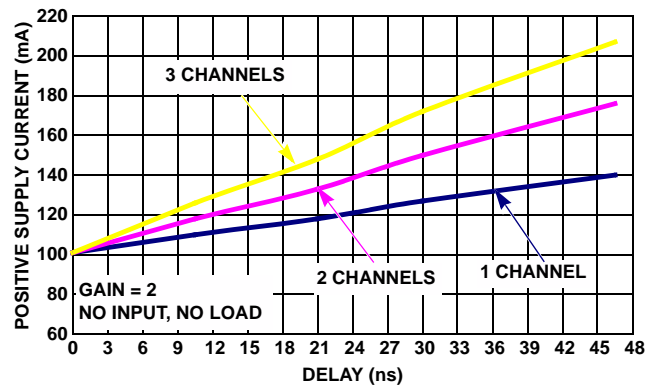

FIGURE 22. ISL59921 POSITIVE SUPPLY CURRENT ( $V_{SP}$ ) vs DELAY TIME

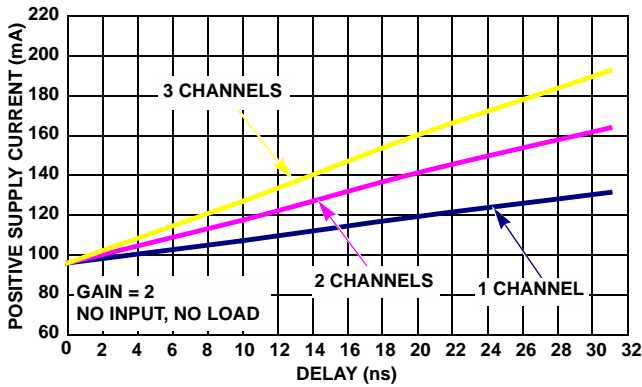

FIGURE 23. ISL59922 POSITIVE SUPPLY CURRENT ( $V_{SP}$ ) vs DELAY TIME

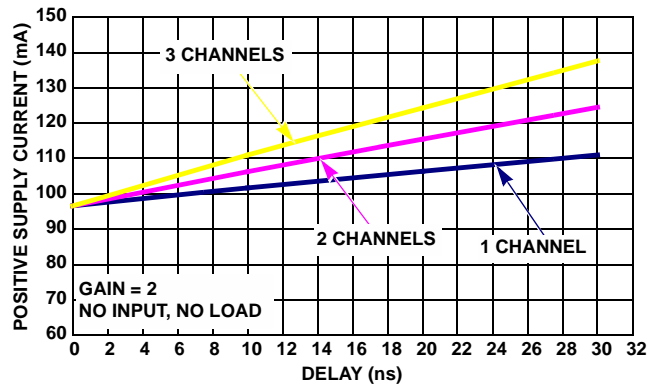

FIGURE 24. ISL59923 POSITIVE SUPPLY CURRENT ( $V_{SP}$ ) vs DELAY TIME

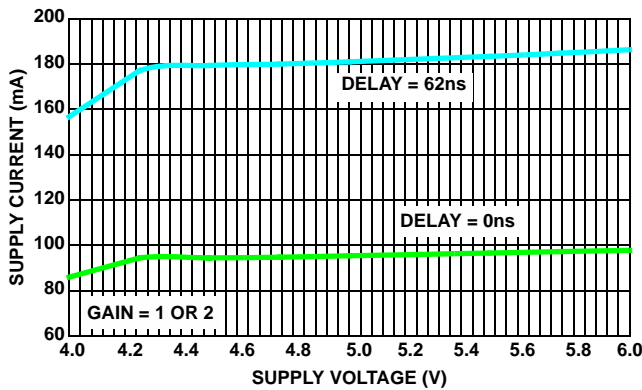

FIGURE 25. ISL59920  $I_{SUPPLY+}$  vs  $V_{SUPPLY+}$

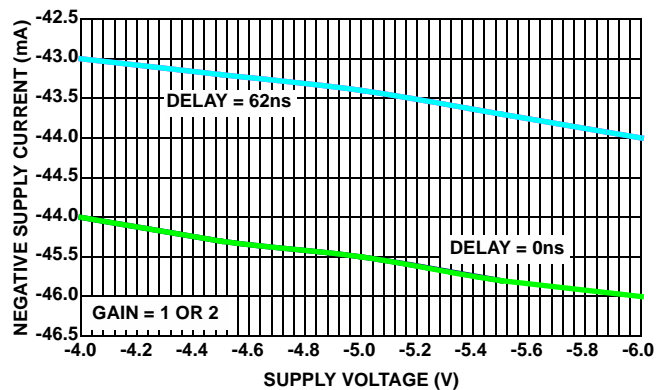

FIGURE 26. ISL59920  $I_{SUPPLY-}$  vs  $V_{SUPPLY-}$

## Typical Performance Curves (Continued)

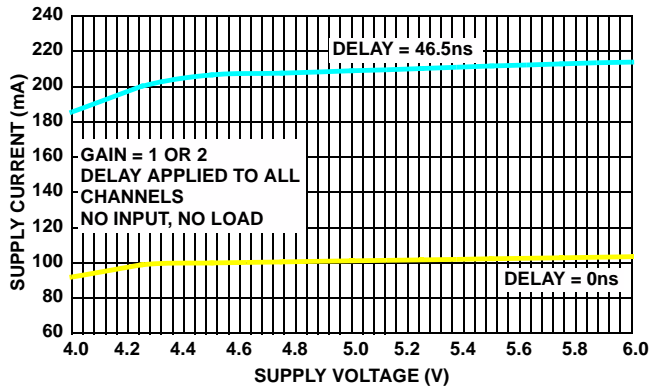

FIGURE 27. ISL59921  $I_{SUPPLY+}$  vs  $V_{SUPPLY+}$

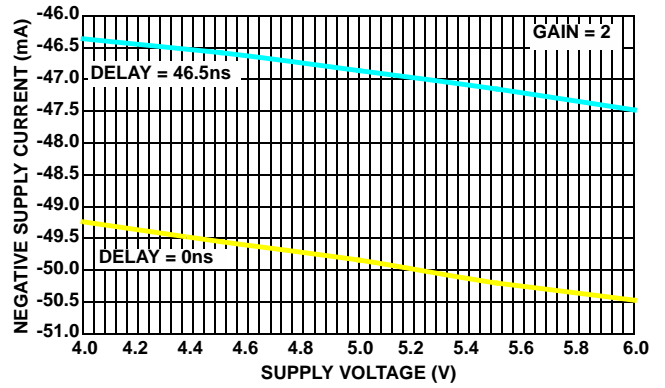

FIGURE 28. ISL59921  $I_{SUPPLY-}$  vs  $V_{SUPPLY-}$

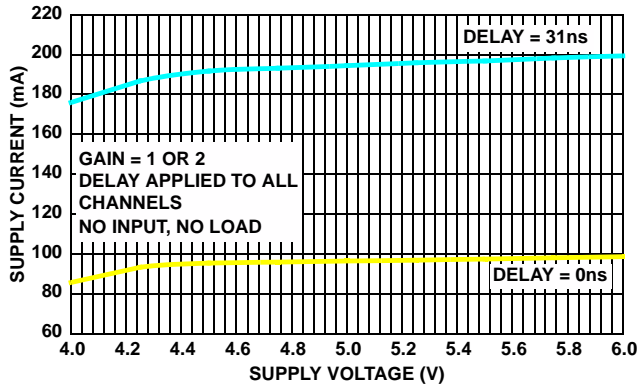

FIGURE 29. ISL59922  $I_{SUPPLY+}$  vs  $V_{SUPPLY+}$

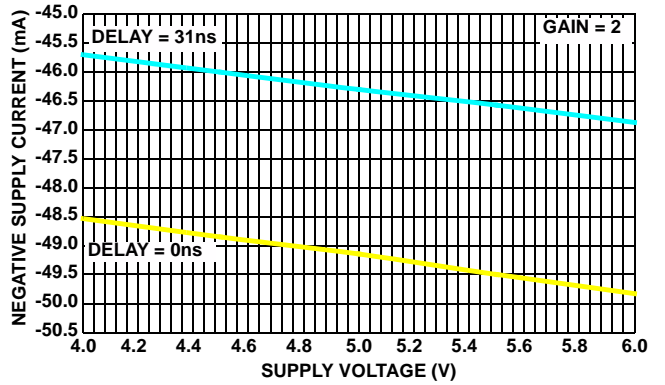

FIGURE 30. ISL59922  $I_{SUPPLY-}$  vs  $V_{SUPPLY-}$

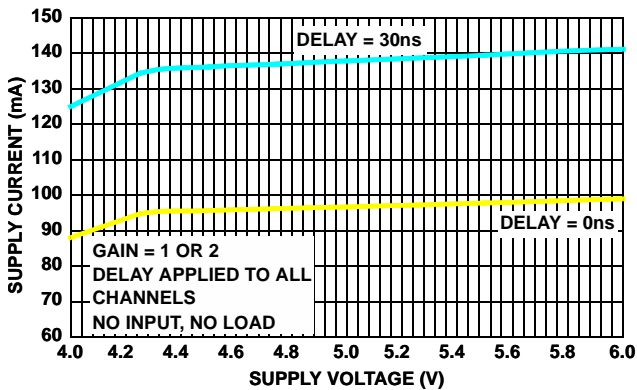

FIGURE 31. ISL59923  $I_{SUPPLY+}$  vs  $V_{SUPPLY+}$

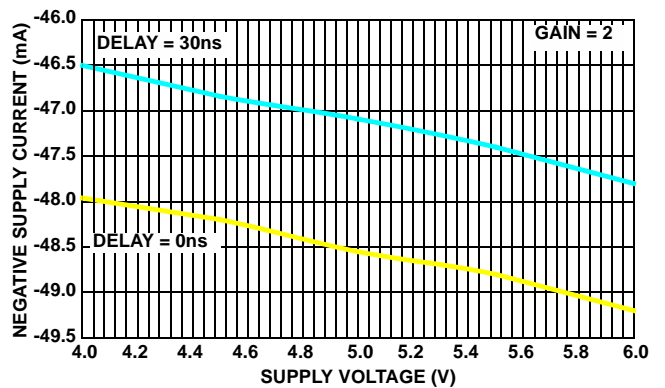

FIGURE 32. ISL59923  $I_{SUPPLY-}$  vs  $V_{SUPPLY-}$

## Typical Performance Curves (Continued)

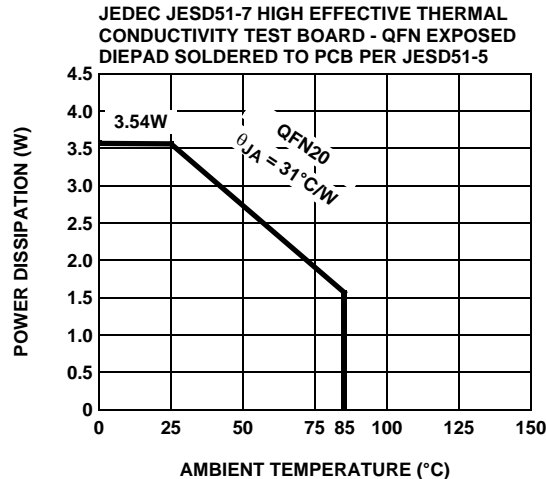

FIGURE 33. PACKAGE POWER DISSIPATION vs AMBIENT TEMPERATURE

## Applications Information

The ISL59920, ISL59921, ISL59922, and ISL59923 are triple analog delay lines that provide skew compensation between three high-speed signals. These devices compensate for time skew introduced by a typical CAT-5, CAT-6 or CAT-7 cable with differing electrical lengths (due to different twist ratios) on each pair. Via their SPI interface, these devices can be programmed to independently compensate for the three different cable delays while maintaining 80MHz bandwidth at their maximum setting. There are four different variations of the ISL5992x (ISL5992x will be used when talking about characteristics that are common to all four devices).

TABLE 1. ISL5992x DELAY VARIATIONS

| PART NUMBER | MAX DELAY (ns) | NOMINAL DELAY INCREMENT (ns) |
|-------------|----------------|------------------------------|
| ISL59920    | 62             | 2.0                          |
| ISL59921    | 46.5           | 1.5                          |
| ISL59922    | 31             | 1.0                          |
| ISL59923    | 30             | 2.0                          |

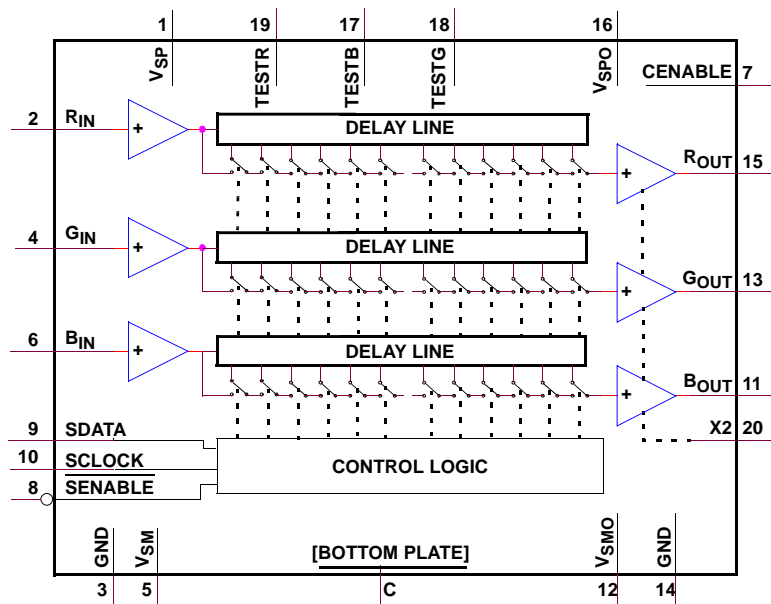

FIGURE 34. ISL59920, ISL59921, ISL59922, ISL59923 BLOCK DIAGRAM

# ISL59920, ISL59921, ISL59922, ISL59923

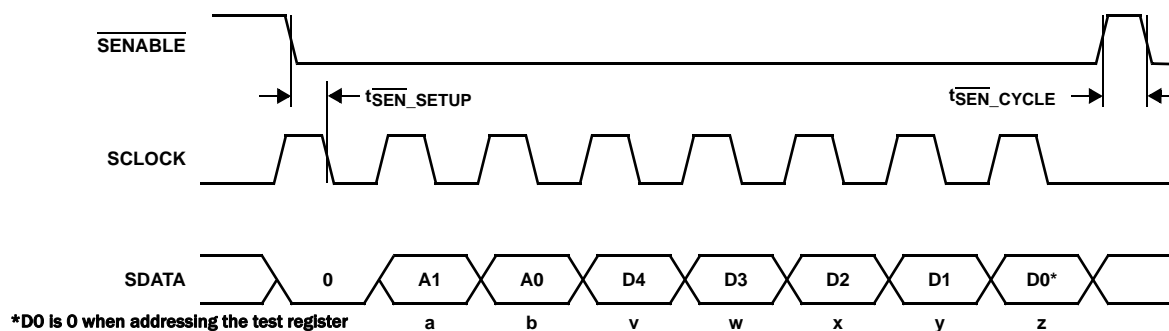

FIGURE 35. SERIAL TIMING

Figure 34 on page 12 shows the ISL5992x block diagram. The 3 analog inputs are ground referenced single-ended signals. After the signal is received, the delay is introduced by switching filter blocks into the signal path. Each filter block is an all-pass filter introducing either 1, 1.5 or 2ns of delay. In addition to adding delay, each filter block also introduces some low pass filtering. As a result, the bandwidth of the signal path decreases from the 0ns delay setting to the maximum delay setting, as shown in Figures 3 through 10 of the “Typical Performance Curves”.

In operation, it is best to allocate the most delayed signal 0ns delay then increase the delay on the other channels to bring them into line. This will result in delay compensation with the lowest power and distortion.

## Serial Bus Operation

The ISL5992x is programmed via 8-bit words sent through its serial interface. The first bit (MSB) of SDATA is latched on the first falling clock edge after SENABLE goes low, as shown in Figure 35. This bit should be a 0 under all conditions. The next two bits determine the color register to be written to: 01 = R, 02 = G, and 03 = B (00 is reserved for the test register). The final five bits set the delay for the specified color. After 8 bits are latched, any additional clocks are treated as a new word (data is shifted directly to the final registers as it is clocked in). This allows the user to write (for example) the 24 bits of data necessary for R, G, and B as a single 24-bit word. It is the user's responsibility to send complete multiples of 8 clock cycles. The serial state machine is reset on the falling edge of SENABLE, so any data corruption that may have occurred due to too many or too few clocks can be corrected with a new word with the correct number of clocks. The initial value of all registers on power-up is 0.

TABLE 2. SERIAL BUS DATA

| vwxyz | ISL59920 DELAY | ISL59921 DELAY | ISL59922 DELAY | ISL59923 DELAY |
|-------|----------------|----------------|----------------|----------------|
| 00000 | 0              | 0              | 0              | 0              |
| 00001 | 2              | 1.5            | 1              | 2              |
| 00010 | 4              | 3              | 2              | 4              |
| 00011 | 6              | 4.5            | 3              | 6              |
| 00100 | 8              | 6              | 4              | 8              |
| 00101 | 10             | 7.5            | 5              | 10             |

TABLE 2. SERIAL BUS DATA (Continued)

| vwxyz | ISL59920 DELAY | ISL59921 DELAY | ISL59922 DELAY | ISL59923 DELAY |
|-------|----------------|----------------|----------------|----------------|
| 00110 | 12             | 9              | 6              | 12             |
| 00111 | 14             | 10.5           | 7              | 14             |
| 01000 | 16             | 12             | 8              | 16             |
| 01001 | 18             | 13.5           | 9              | 18             |
| 01010 | 20             | 15             | 10             | 20             |
| 01011 | 22             | 16.5           | 11             | 22             |
| 01100 | 24             | 18             | 12             | 24             |
| 01101 | 26             | 19.5           | 13             | 26             |
| 01110 | 28             | 21             | 14             | 28             |
| 01111 | 30             | 22.5           | 15             | 30             |
| 10000 | 32             | 24             | 16             | N/A            |
| 10001 | 34             | 25.5           | 17             | N/A            |
| 10010 | 36             | 27             | 18             | N/A            |
| 10011 | 38             | 28.5           | 19             | N/A            |
| 10100 | 40             | 30             | 20             | N/A            |
| 10101 | 42             | 31.5           | 21             | N/A            |
| 10110 | 44             | 33             | 22             | N/A            |
| 10111 | 46             | 34.5           | 23             | N/A            |
| 11000 | 48             | 36             | 24             | N/A            |
| 11001 | 50             | 37.5           | 25             | N/A            |
| 11010 | 52             | 39             | 26             | N/A            |
| 11011 | 54             | 40.5           | 27             | N/A            |
| 11100 | 56             | 42             | 28             | N/A            |
| 11101 | 58             | 43.5           | 29             | N/A            |
| 11110 | 60             | 45             | 30             | N/A            |
| 11111 | 62             | 46.5           | 31             | N/A            |

NOTE: Delay register word = 0abvwxyz; Red register - ab = 01; Green register - ab = 10; Blue register - ab = 11; vwxyz selects delay; ab = 00 writes to the test register to change the DAC slice level.

## Offset Compensation

To counter the effects of offset, the ISL5992x incorporates an offset compensation circuit that reduces the offset to less than  $\pm 25\text{mV}$ . An offset correction cycle is triggered by the rising edge of the  $\overline{\text{SENABLE}}$  pin after writing a delay word to any of the 3 channels. The offset calibration starts about 500ns after the  $\overline{\text{SENABLE}}$  rising edge to allow the ISL5992x time to settle (electrically and thermally) to the new delay setting. It lasts about  $2.5\mu\text{s}$ , for a total offset correction time of  $3.0\mu\text{s}$ . During calibration, the ISL5992x's inputs are internally shorted together (however the characteristics of the ISL5992x's differential input pins stay the same), and the offset of the output stage is adjusted until it has been minimized.

In addition to automatically triggering after a delay change (or any register write), an additional offset calibration may be initiated at any time, such as:

- When the die temperature changes. Applying power to the ISL5992x will cause the die temperature to quickly increase then slowly settle over 20 to 30ns. Because the ISL5992x powers-down unused delay stages (to minimize power consumption), the die temp will also change and settle after a delay change. Initiating an offset 20ns (or longer, depending on the thermal characteristics of the system) after power-on or a delay change will minimize the offset in normal operation thereafter.
- When the ambient temperature changes. If you are monitoring the temperature, initiate a calibration every time the temperature shifts by 5 to 10 degrees. If you are not monitoring temperature, initiate a calibration periodically, as expected by the environment the device is in.
- After a  $\overline{\text{CENABLE}}$  (Chip Enable) cycle. The  $\overline{\text{CENABLE}}$  pin may be taken low to put the ISL5992x in a low power standby mode to conserve power when not needed. When the  $\overline{\text{CENABLE}}$  pin goes high to exit this low power mode, the ISL5992x will recall the delay settings but it will *not* recall the correct offset calibration settings, so to maintain low offset, a write to the delay register is required after a  $\overline{\text{CENABLE}}$  cycle. Offset errors may be as large as  $\pm 200\text{mV}$  coming out of standby mode - **recalibration is a necessity**. For best performance, initiate an additional calibration again once the die temperature has settled (20 to 30ns after coming out of standby).
- After a gain change (X2 pin changes state). The systematic offset is different for a gain of x1 vs. a gain of x2, so an offset calibration is recommended after a gain change. However in a typical application the gain is permanently fixed at x1 or x2, so this is not usually a concern.

## Offset Calibration with Sync-On-Video

The offset correction mechanism temporarily disconnects the input signals to perform the offset calibration. This introduces several discontinuities in the video signal, as shown in [Figure 11](#) on [page 8](#):

- 200mV to 300mV spike when calibration is engaged
- Successive approximation offset null
- 200mV to 300mV spike when calibration is disengaged
- In addition, because an offset calibration is performed any time the delay changes, the output video signal may be moved forward or back in time by up to 62ns.

If the video signals going through the ISL5992x contain only video (with no sync signals), this appears as a  $2\mu\text{s}$  "sparkle" on the screen - usually it is not even visible to the eye.

However if sync signals are embedded on the video, the spikes may be misinterpreted as a sync signal, causing the downstream circuitry to see an asynchronous sync pulse. In some receiving systems (typically monitors), a single asynchronous sync pulse can cause the system to think the video signal has changed. Depending on the receiving monitor's design, this can initiate a new video acquisition cycle (for example, the monitor blanks the screen while it measures the "new" HSYNC and VSYNC timing, selects the right mode, and optimizes the image). This can cause the monitor to go blank for up to several seconds after a single delay change.

Since this only happens at power-on and when the delays are initially set, this is not a problem in normal use, but if the monitor is blanking for several seconds every time the delay is adjusted, it can cause calibration to take longer than absolutely necessary. If this behavior is undesirable, it can be eliminated as follows:

1. Synchronize the rising edge of  $\overline{\text{SENABLE}}$  to the sync pulse, so that the  $\overline{\text{SENABLE}}$  goes high immediately after the trailing edge of the sync pulse.  $\overline{\text{SENABLE}}$  can be taken low and the serial data written asynchronously at any time - it is the *rising* edge of  $\overline{\text{SENABLE}}$  that triggers a calibration.
2. If the Sync Processor is part of the same design as ISL5992x, ensure that the sync processor ignores the first x microseconds after a valid sync, where  $x = 3\mu\text{s} +$  the delay between the end of a sync and rising edge of  $\overline{\text{SENABLE}}$ . This will prevent the sync processor from generating invalid sync signals due to the spikes.
3. If the Sync Processor is external to the design with the ISL5992x (video with Sync-On-Green, for example), the video signal should be disconnected from the ISL59920 and shorted to ground via an analog switch for the first x microseconds after a valid sync, where  $x = 3\mu\text{s} +$  the delay between the end of a sync and rising edge of  $\overline{\text{SENABLE}}$ . This will remove the calibration signals from the video signal.

These steps are only necessary if the sync signal is embedded on the video.

Note: Avoid possible monitor blanking during skew adjustment.

## Test Pins

Three test pins are provided (Test R, Test G, Test B). During normal operation, the test pins output pulses of current for a duration of the overlap between the inputs, as shown in [Figure 36](#):

TEST<sub>R</sub> pulse = RED<sub>OUT</sub> (A) with respect to GREEN<sub>OUT</sub> (B)

TEST<sub>G</sub> pulse = GREEN<sub>OUT</sub> with respect to BLUE<sub>OUT</sub>

TEST<sub>B</sub> pulse = BLUE<sub>OUT</sub> with respect to RED<sub>OUT</sub>

Averaging the current gives a direct measure of the delay between the two edges. When A precedes B, the current pulse is +50µA, and the output voltage goes up. When B precedes A, the pulse is -50µA.

For the logic to work correctly, A and B must have a period of overlap while they are high (a delay longer than the pulse width cannot be measured).

Signals A and B are derived from the video input by comparing the video signal with a slicing level, which is set by an internal DAC. This enables the delay to be measured either from the rising edges of sync-like signals encoded on top of the video or from a dedicated set-up signal. The outputs can be used to set the correct delays for the signals received.

The DAC level is set through the serial input by bits 1 through 4 directed to the test register (00).

## Internal DAC Voltage

The slice level of the internal DAC may be programmed by writing a byte to the test register (00). [Table 3](#) shows the values that should be written to change the DAC slice level. Please keep in mind when writing to the test register that the LSB should always be zero.

Referred to the input, the DAC slice range for the ISL5992x is cut in half for gain of 2 mode because the slicing occurs after the x1/x2 stage output amplifier. (In the EL9115, the slicing occurred before the amplifier so the range of the DAC voltage was the same for either gain of 1 or gain of 2).

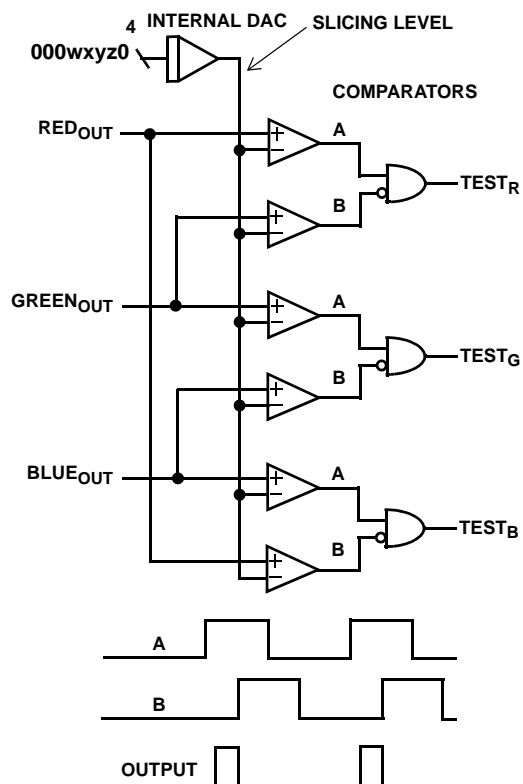

FIGURE 36. DELAY DETECTOR

TABLE 3. DAC VOLTAGE RANGE - INPUT REFERRED

| wxyz | DAC RANGE [mV]<br>(GAIN 1) | DAC RANGE [mV]<br>(GAIN 2) |
|------|----------------------------|----------------------------|
| 1000 | -400                       | -200                       |
| 1001 | -350                       | -175                       |
| 1010 | -300                       | -150                       |
| 1011 | -250                       | -125                       |
| 1100 | -200                       | -100                       |
| 1101 | -150                       | -75                        |
| 1110 | -100                       | -50                        |
| 1111 | -50                        | -25                        |
| 0000 | 0                          | 0                          |
| 0001 | 50                         | 25                         |
| 0010 | 100                        | 50                         |
| 0011 | 150                        | 75                         |
| 0100 | 200                        | 100                        |
| 0101 | 250                        | 125                        |
| 0110 | 300                        | 150                        |
| 0111 | 350                        | 175                        |

NOTE: Test Register word = 000wxyz0. wxyz fed to DAC. z is LSB

## CENABLE at Power-On

To guarantee proper operation, the CENABLE pin should be held low for at least 30ms after the power supply has settled to within 5% of its final value.

If CENABLE cannot be guaranteed to be held low during this time, an RC delay can be inserted between the CENABLE source and the CENABLE input to meet this requirement as shown in [Figure 37](#).  $R_1$  and  $C_1$  generate an ~33ms delay, and  $D_1$  discharges any charge on  $C_1$  when the power to the ISL5992x is removed.

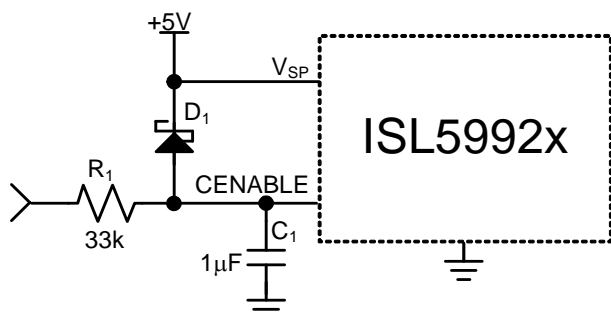

FIGURE 37. CENABLE RC DELAY

## Power Dissipation

As the delay setting increases, additional filter blocks turn on and insert into the signal path. When the delay per channel increments,  $V_{SP}$  current increases by 0.9mA while  $V_{SM}$  does not change significantly. Under the extreme settings, the positive supply current reaches 141mA and the negative supply current can be 41mA. Operating at  $\pm 5V$  power supply, the worst-case ISL5992x power dissipation is shown by [Equation 1](#):

$$PD = 5 \cdot 141mA + 5 \cdot 41mA = 910mW \quad (EQ. 1)$$

The minimum  $\theta_{JA}$  required for long term reliable operation of the ISL5992x is calculated using [Equation 2](#):

$$\theta_{JA} = (T_J - T_A) / PD = 55^\circ C/W \quad (EQ. 2)$$

Where:

$T_J$  is the maximum junction temperature (+135°C)

$T_A$  is the maximum ambient temperature (+85°C)

For a 20 Ld package on a well laid-out PCB with good connectivity between the QFN's pad and the PCB copper area, 31°C/W  $\theta_{JA}$  thermal resistance can be achieved. This yields a much higher power dissipation of 3.54W using [Equation 2](#) (see [Figure 33](#)). To disperse the heat, the bottom heat spreader must be soldered to the PCB. Heat flows through the heat spreader to the circuit board copper then spreads and convects to air. Thus, the PCB copper plane becomes the heatsink (see [TB389](#)). This has proven to be a very effective technique. A separate application note, which details the 20 Ld QFN PCB design considerations, is available.



## Revision History

The revision history provided is for informational purposes only and is believed to be accurate, but not warranted. Please go to the web to make sure that you have the latest revision.

| DATE               | REVISION | CHANGE  |
|--------------------|----------|---|
| September 25, 2014 | FN6826.3 | Added Revision History.<br><br>Converted to new datasheet template.<br><br>Added note on CENABLE delay to CENABLE entry in Pin Descriptions table on page 2.<br>Added "CENABLE at Power-On" on page 16. |

---

## About Intersil

Intersil Corporation is a leading provider of innovative power management and precision analog solutions. The company's products address some of the largest markets within the industrial and infrastructure, mobile computing and high-end consumer markets.

For the most updated datasheet, application notes, related documentation and related parts, please see the respective product information page found at [www.intersil.com](http://www.intersil.com).

You may report errors or suggestions for improving this datasheet by visiting [www.intersil.com/ask](http://www.intersil.com/ask).

Reliability reports are also available from our website at [www.intersil.com/support](http://www.intersil.com/support)

# ISL59920, ISL59921, ISL59922, ISL59923

## Quad Flat No-Lead Plastic Package (QFN)

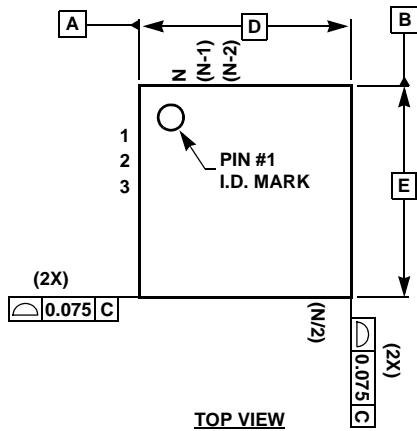

TOP VIEW

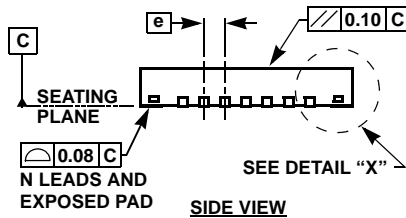

SIDE VIEW

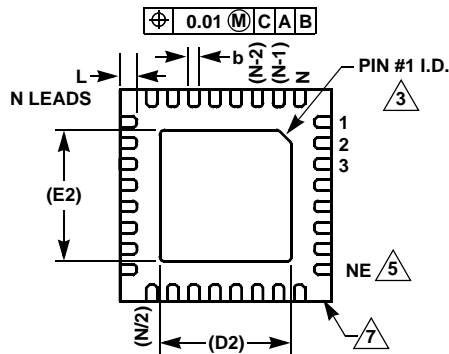

BOTTOM VIEW

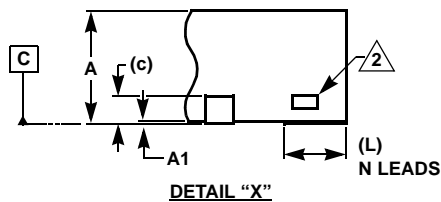

DETAIL "X"

## L20.5x5C

20 LEAD QUAD FLAT NO-LEAD PLASTIC PACKAGE  
(COMPLIANT TO JEDEC MO-220)

| SYMBOL | MILLIMETERS |         |      | NOTES |
|--------|-------------|---------|------|-------|
|        | MIN         | NOMINAL | MAX  |       |
| A      | 0.80        | 0.90    | 1.00 | -     |
| A1     | 0.00        | 0.02    | 0.05 | -     |
| b      | 0.28        | 0.30    | 0.32 | -     |
| c      | 0.20 REF    |         |      | -     |
| D      | 5.00 BASIC  |         |      | -     |
| D2     | 3.70 REF    |         |      | 8     |
| E      | 5.00 BASIC  |         |      | -     |
| E2     | 3.70 REF    |         |      | 8     |
| e      | 0.65 BASIC  |         |      | -     |
| L      | 0.35        | 0.40    | 0.45 | -     |
| N      | 20          |         |      | 4     |
| ND     | 5 REF       |         |      | 6     |
| NE     | 5 REF       |         |      | 5     |

Rev. 0 6/06

### NOTES:

1. Dimensioning and tolerancing per ASME Y14.5M-1994.
2. Tiebar view shown is a non-functional feature.
3. Bottom-side pin #1 I.D. is a diepad chamfer as shown.
4. N is the total number of terminals on the device.
5. NE is the number of terminals on the "E" side of the package (or Y-direction).
6. ND is the number of terminals on the "D" side of the package (or X-direction).  $ND = (N/2) - NE$ .
7. Inward end of terminal may be square or circular in shape with radius  $(b/2)$  as shown.
8. If two values are listed, multiple exposed pad options are available. Refer to device-specific datasheet.
9. One of 10 packages in MDP0046

For additional products, see [www.intersil.com/en/products.html](http://www.intersil.com/en/products.html)

Intersil products are manufactured, assembled and tested utilizing ISO9001 quality systems as noted in the quality certifications found at [www.intersil.com/en/support/qualandreliability.html](http://www.intersil.com/en/support/qualandreliability.html)

Intersil products are sold by description only. Intersil Corporation reserves the right to make changes in circuit design, software and/or specifications at any time without notice. Accordingly, the reader is cautioned to verify that data sheets are current before placing orders. Information furnished by Intersil is believed to be accurate and reliable. However, no responsibility is assumed by Intersil or its subsidiaries for its use; nor for any infringements of patents or other rights of third parties which may result from its use. No license is granted by implication or otherwise under any patent or patent rights of Intersil or its subsidiaries.

For information regarding Intersil Corporation and its products, see [www.intersil.com](http://www.intersil.com)

# Mouser Electronics

Authorized Distributor

Click to View Pricing, Inventory, Delivery & Lifecycle Information:

[Intersil:](#)

[ISL59920IRZ](#) [ISL59920IRZ-T7](#) [ISL59921IRZ](#) [ISL59921IRZ-T7](#) [ISL59922IRZ](#) [ISL59922IRZ-T7](#) [ISL59923IRZ](#)  
[ISL59923IRZ-T7](#)