

## FULLY PROTECTED POWER MOSFET SWITCH

### Features

- Extremely rugged for harsh operating environments
- Over-temperature protection
- Over-current protection
- Active drain-to-source clamp
- ESD protection
- Lead compatible with standard Power MOSFET
- Low operating input current
- Monolithic construction

### Description

The IRSF3011 is a three-terminal monolithic Smart Power MOSFET with built-in short circuit, over-temperature, ESD and over-voltage protections.

The on-chip protection circuit latches off the Power MOSFET in case the drain current exceeds 7A (typical) or the junction temperature exceeds 165°C (typical) and keeps it off until the input is driven low. The drain to source voltage is actively clamped at 55V (typical), prior to the avalanche of Power MOSFET, thus improving its performance during turn-off with inductive loads.

The input current requirements are very low (300µA) which makes the IRSF3011 compatible with most existing designs based on standard Power MOSFETs.

### Block Diagram

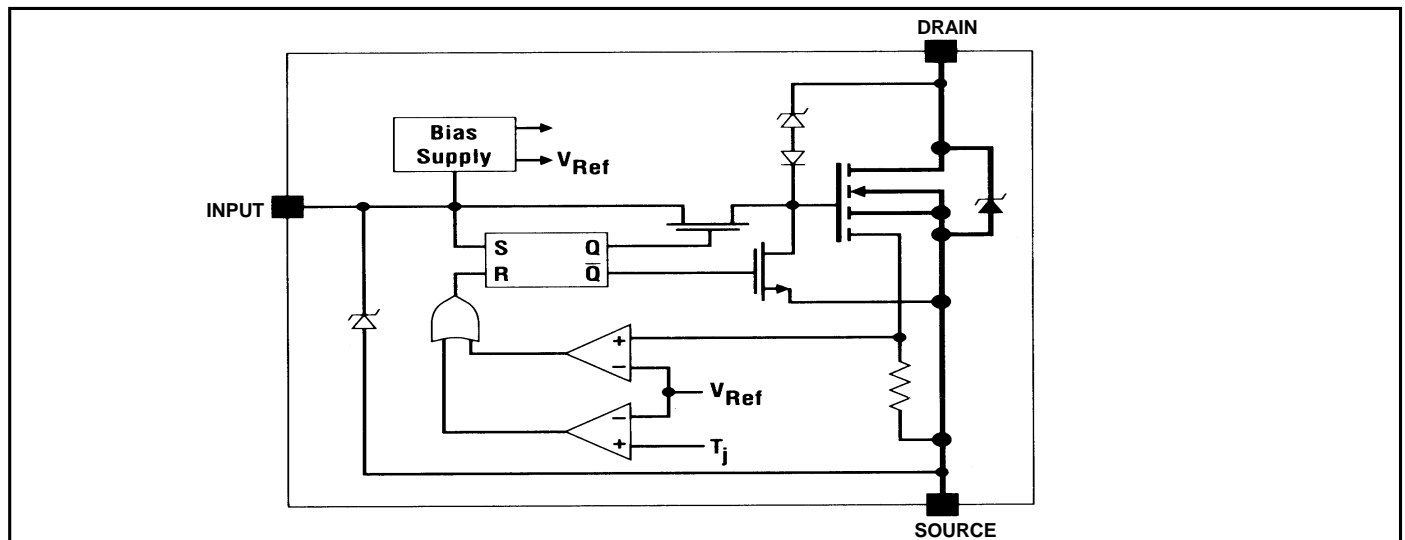

### Product Summary

$V_{ds(clamp)}$	50V
$R_{ds(on)}$	200mW
$I_{ds(sd)}$	7A
$T_{j(sd)}$	165°C
EAS	200mJ

### Applications

- Solenoid Driver
- DC Motor Driver

### Available Packages

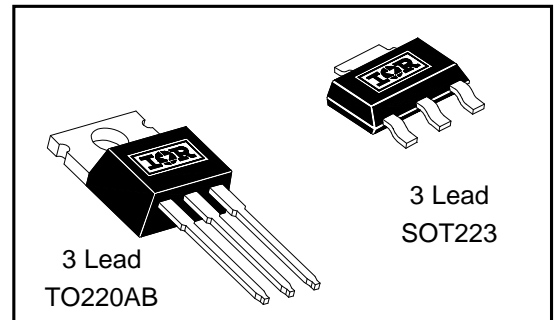

## Absolute Maximum Ratings

Absolute maximum ratings indicate sustained limits beyond which damage to the device may occur.  
( $T_C = 25^\circ\text{C}$  unless otherwise specified.)

Symbol	Parameter	Min.	Max.	Units	Test Conditions
$V_{ds, \max}$	Continuous drain to source voltage	—	50	V	
$V_{in, \max}$	Continuous input voltage	-0.3	10		
$I_{ds}$	Continuous drain current	—	self limited	A	
$P_d$	Power dissipation	—	30	W	$T_C \leq 25^\circ\text{C}$ , TO220
		—	3		$T_C \leq 25^\circ\text{C}$ , SOT223
EAS	Unclamped single pulse inductive energy <sup>①</sup>	—	200	mJ	
$V_{esd1}$	Electrostatic discharge voltage (Human Body Model)	—	4000	V	100pF, 1.5kW
$V_{esd2}$	Electrostatic discharge voltage (Machine Model)	—	1000		200pF, 0W
$T_{Jop}$	Operating junction temperature range	-55	150	°C	
$T_{Stg}$	Storage temperature range	-55	150		
$T_L$	Lead temperature (soldering, 10 seconds)	—	300		

## Static Electrical Characteristics

( $T_C = 25^\circ\text{C}$  unless otherwise specified.)

Symbol	Parameter	Min.	Typ.	Max.	Units	Test Conditions
$V_{ds, \text{clamp}}$	Drain to source clamp voltage	50	54	—	V	$I_{ds} = 10\text{mA}$
		—	56	62		$I_{ds} = 6\text{A}$ , $t_p = 700 \text{ms}$
$R_{ds(\text{on})}$	Drain to source on resistance	—	155	200	mW	$V_{in} = 5\text{V}$ , $I_{ds} = 2\text{A}$
		—	200	—		$V_{in} = 4\text{V}$ , $I_{ds} = 2\text{A}$
		—	115	—		$V_{in} = 10\text{V}$ , $I_{ds} = 2\text{A}$
$I_{dss}$	Drain to source leakage current	—	—	10	mA	$V_{ds} = 12\text{V}$ , $V_{in} = 0\text{V}$
		—	—	100		$V_{ds} = 50\text{V}$ , $V_{in} = 0\text{V}$
		—	10	250		$V_{ds} = 40\text{V}$ , $V_{in} = 0\text{V}$ , $T_C = 150^\circ\text{C}$
$V_{th}$	Input threshold voltage	1.5	2.0	2.5	V	$V_{ds} = 5\text{V}$ , $I_{ds} = 10\text{mA}$
$I_{i, \text{on}}$	Input supply current (normal operation)	—	0.25	0.6	mA	$V_{in} = 5\text{V}$
		—	0.35	0.85		$V_{in} = 10\text{V}$
$I_{i, \text{off}}$	Input supply current (protection mode)	—	0.5	1.0	mA	$V_{in} = 5\text{V}$
		—	0.6	1.2		$V_{in} = 10\text{V}$
$V_{in, \text{clamp}}$	Input clamp voltage	10	10.8	—	V	$I_{in} = 10\text{mA}$
$V_{sd}$	Body-drain diode forward drop <sup>③</sup>	—	1.2	1.5	V	$I_{ds} = -9\text{A}$ , $R_{in} = 1\text{k}\Omega$

## Thermal Characteristics

Symbol	Parameter	Min.	Typ.	Max.	Units	Test Conditions
$R_{thjc}$	Junction to case	—	—	4	°C/W	TO-220AB
$R_{thja}$	Junction to ambient	—	—	60		
$R_{thjc}$	Junction to case	—	—	40		SOT-223
$R_{thja}$	Junction to PCB <sup>①</sup>	—	—	60		

## Switching Electrical Characteristics

( $V_{CC} = 14V$ , resistive load ( $R_L$ ) = 5W,  $T_C = 25^\circ C$ .) Please refer to figure 3 for switching time definitions.

Symbol	Parameter	Min.	Typ.	Max.	Units	Test Conditions
t <sub>don</sub>	Turn-on delay time	—	160	250	nS	V <sub>in</sub> = 5V
		—	90	—		V <sub>in</sub> = 10V
t <sub>r</sub>	Rise time	—	650	1200		V <sub>in</sub> = 5V
		—	250	—		V <sub>in</sub> = 10V
t <sub>doff</sub>	Turn-off delay time	—	250	350		V <sub>in</sub> = 5V
		—	300	—		V <sub>in</sub> = 10V
t <sub>f</sub>	Fall time	—	180	350	V <sub>in</sub> = 5V	
		—	170	—	V <sub>in</sub> = 10V	

## Protection Characteristics

( $T_C = 25^\circ C$  unless otherwise specified.)

Symbol	Parameter	Min.	Typ.	Max.	Units	Test Conditions
I <sub>ds(sd)</sub>	Over-current shutdown threshold	5	7	10	A	V <sub>in</sub> = 5V
T <sub>j(sd)</sub>	Over temperature shutdown threshold	155	165	—	°C	V <sub>in</sub> = 5V, I <sub>ds</sub> = 2A
V <sub>protect</sub>	Min. input voltage for over-temp function	—	3	—	V	
t <sub>lresp</sub>	Over current response time	—	4	—	mS	See Figure 4 for definition
t <sub>lblank</sub>	Over current blanking time	—	4	—		See Figure 4 for definition
I <sub>peak</sub>	Peak short circuit current	—	16	—	A	See Figure 4 for definition
V <sub>reset</sub>	Protection reset voltage	—	1.3	—	V	
t <sub>reset</sub>	Protection reset time	—	8	—	mS	See Figure 5 for definition
t <sub>Tresp</sub>	Over-temperature response time	—	12	—		See Figure 6 for definition

## Temperature Coefficients of Electrical Characteristics

(Please see Figures 7 through 18 for more data on thermal characteristics of other electrical parameters.)

Symbol	Parameter	Min.	Typ.	Max.	Units	Test Conditions
V <sub>ds,clamp</sub>	Drain-to-source clamp voltage T.C.	—	18.2	—	mV/°C	I <sub>ds</sub> = 10mA
V <sub>th</sub>	Input threshold voltage T.C.	—	-2.7	—		V <sub>ds</sub> = 5V, I <sub>ds</sub> = 10mA
V <sub>in,clamp</sub>	Input clamp voltage T.C.	—	7.0	—		I <sub>in</sub> = 10mA
I <sub>ds(sd)</sub>	Over-current shutdown threshold T.C.	—	-9.8	—	mA/°C	V <sub>in</sub> = 5V

### NOTES:

- ① When mounted on a 1" square PCB (FR-4 or G10 material). For recommended footprint and soldering techniques, refer to International Rectifier Application Note AN-994.
- ② E<sub>AS</sub> is tested with a constant current source of 6A applied for 700mS with V<sub>in</sub> = 0V and starting T<sub>j</sub> = 25°C.
- ③ Input current must be limited to less than 5mA with a 1kw resistor in series with the input when the Body-Drain Diode is forward biased.

## Lead Assignments

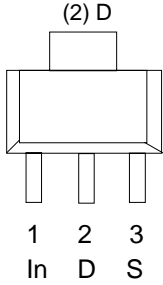
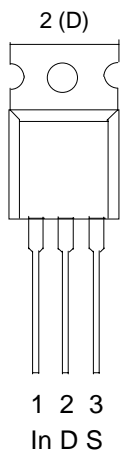
 <p>(2) D</p> <p>1 2 3 In D S</p> <p>3 Lead - SOT223</p> <p><b>IRSF3011L</b></p>	 <p>2 (D)</p> <p>1 2 3 In D S</p> <p>3 Lead - TO220</p> <p><b>IRSF3011</b></p>
<b>Part Number</b>	

## Case Outline 3 Lead - TO220

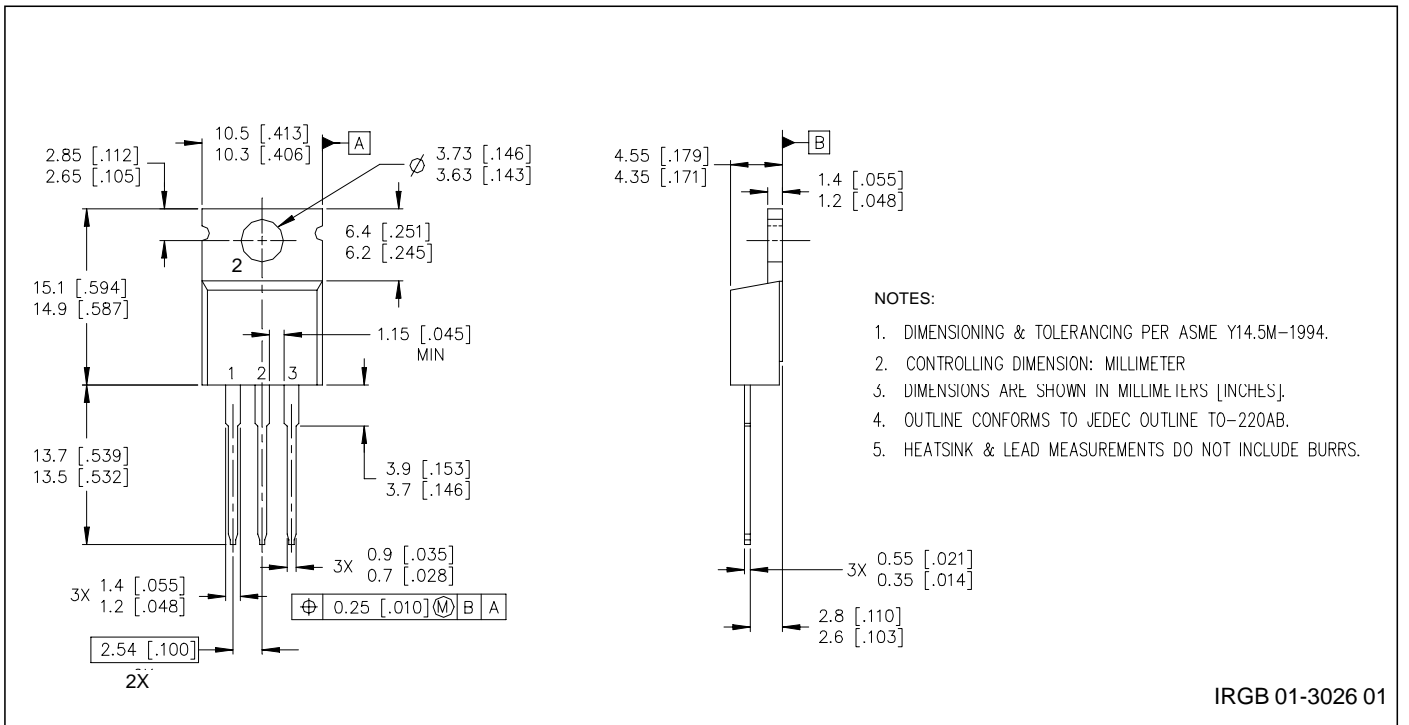

IRGB 01-3026 01

**Case Outline 3 Lead - SOT-223**

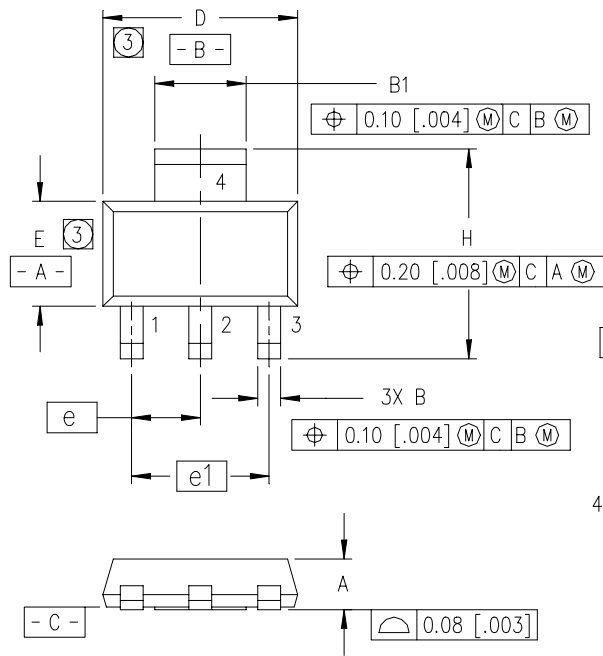

LEAD ASSIGNMENTS

- 1 = GATE
- 2 = DRAIN
- 3 = SOURCE
- 4 = DRAIN

DIM	MILLIMETERS		INCHES	
	MIN	MAX	MIN	MAX
A	1.55	1.80	.061	.071
B	0.65	0.85	.026	.033
B1	2.95	3.15	.116	.124
C	0.25	0.35	.010	.014
D	6.30	6.70	.248	.264
E	3.30	3.70	.130	.146
e	2.30	BSC	.0905	BSC
e1	4.60	BSC	.181	BSC
H	6.71	7.29	.287	.264
L	0.91	—	.036	—
L1	0.061	BSC	.0024	BSC
y	—	10°	—	10°

MINIMUM RECOMMENDED FOOTPRINT

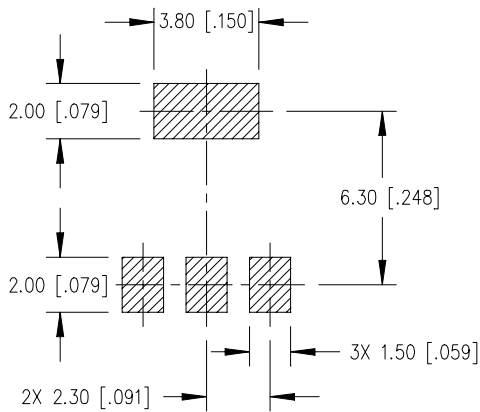

NOTES:

1. DIMENSIONING & TOLERANCING PER ANSI Y14.5M-1982.
2. CONTROLLING DIMENSION: INCH.
- ③ DIMENSIONS DO NOT INCLUDE MOLD FLASH.
4. OUTLINE CONFORMS TO JEDEC OUTLINE TO-261AA.
5. DIMENSIONS ARE SHOWN IN MILLIMETERS [INCHES].

IRGB X01-3032 00

## Tape & Reel - SOT223

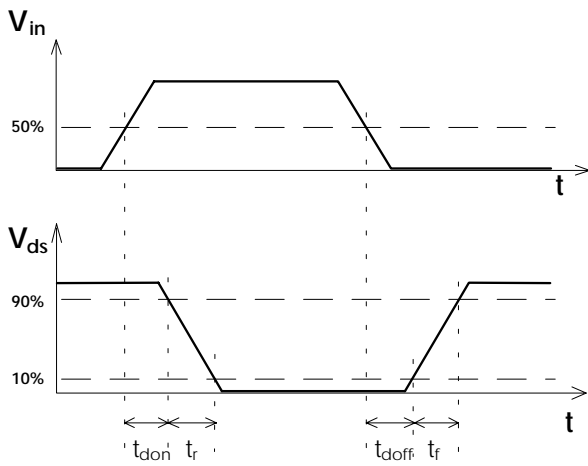
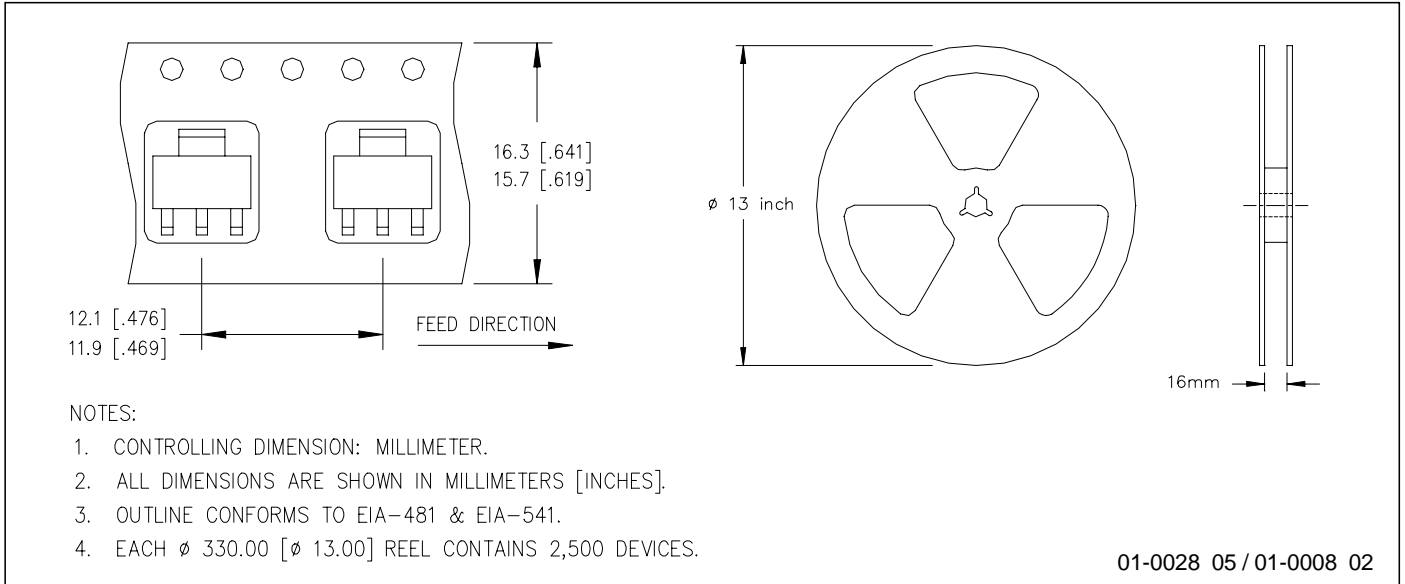

Figure 3 Definition of Switching Times

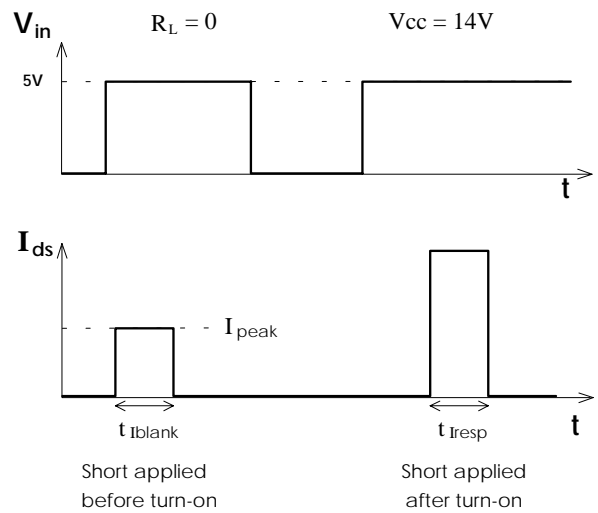

Figure 4 Definition of  $I_{peak}$ ,  $t_{blank}$ ,  $t_{resp}$

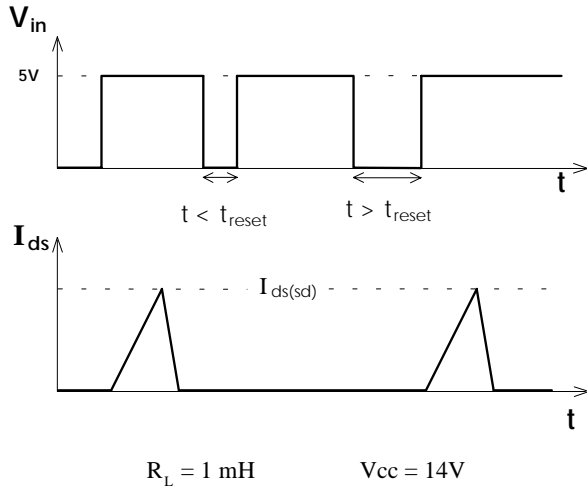

Figure 5 Definition of  $t_{\text{reset}}$

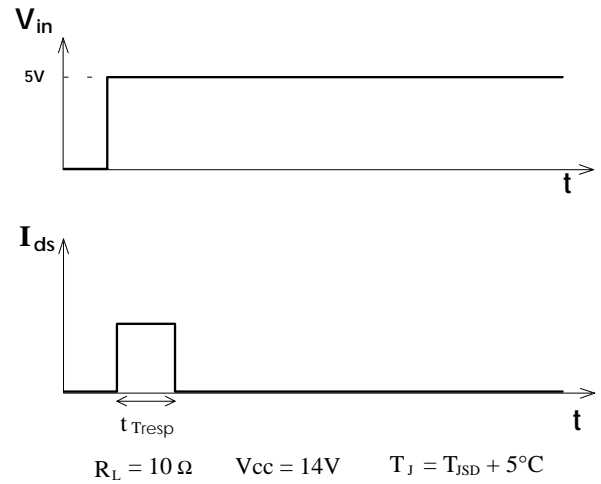

Figure 6 Definition of  $t_{\text{Tresp}}$

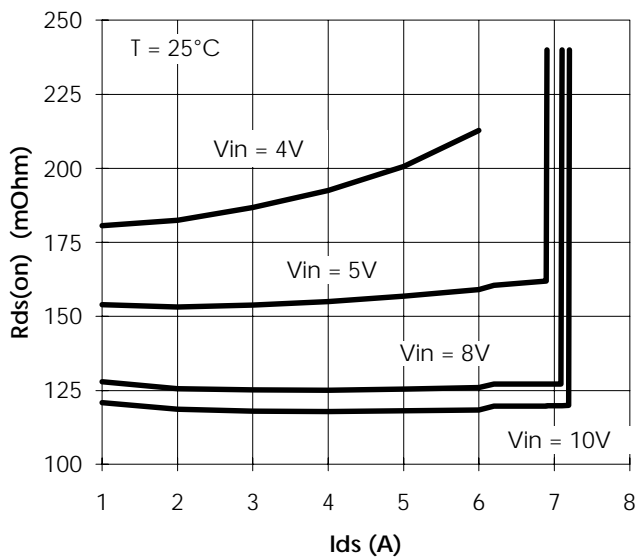

Figure 7 On Resistance vs. Drain-to-Source Current

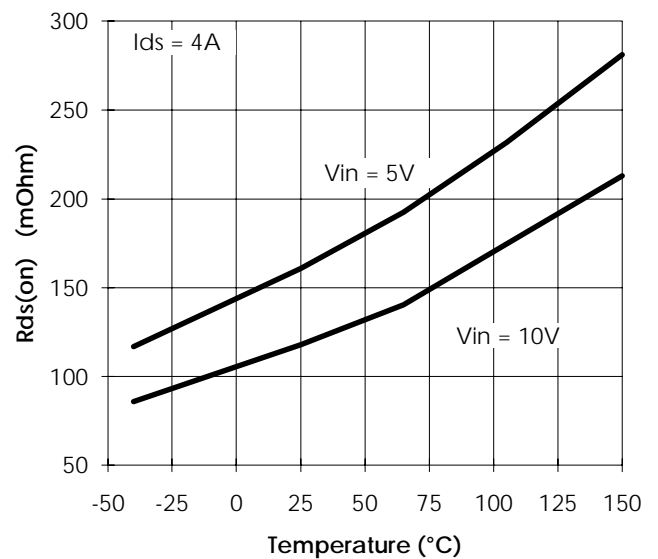

Figure 8 On Resistance vs. Temperature

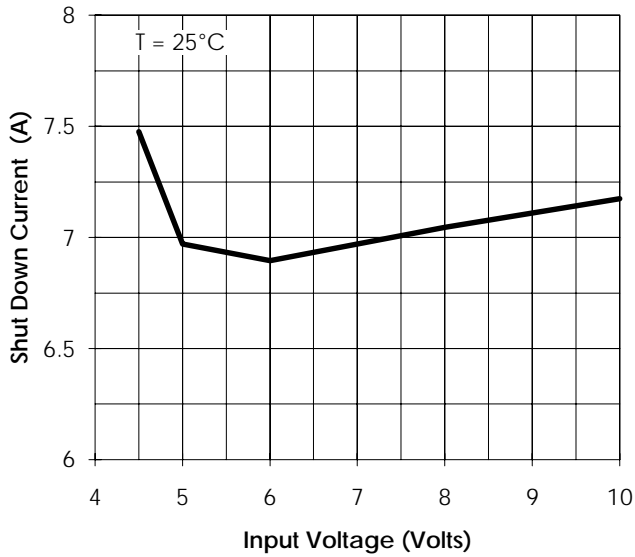

Figure 9 Over-Current Shutdown Threshold vs. Input Voltage

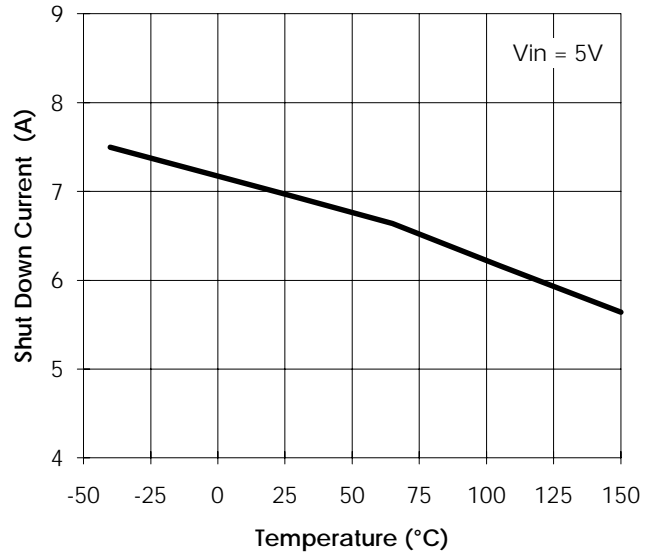

Figure 10 Over-Current Shutdown Threshold vs. Temperature

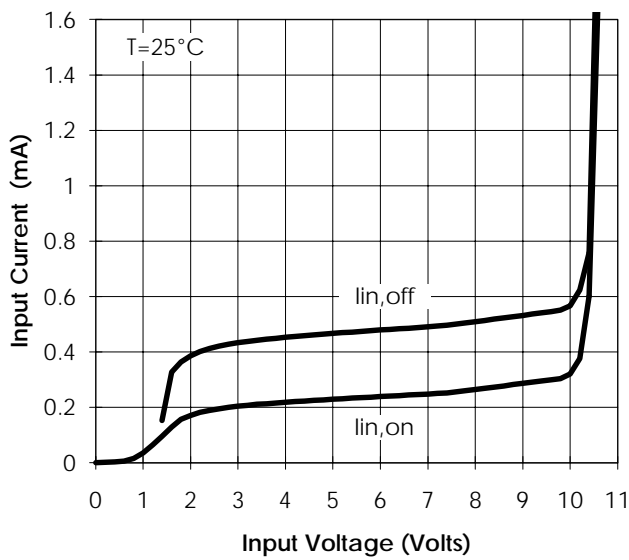

Figure 11 Input Current vs. Input Voltage

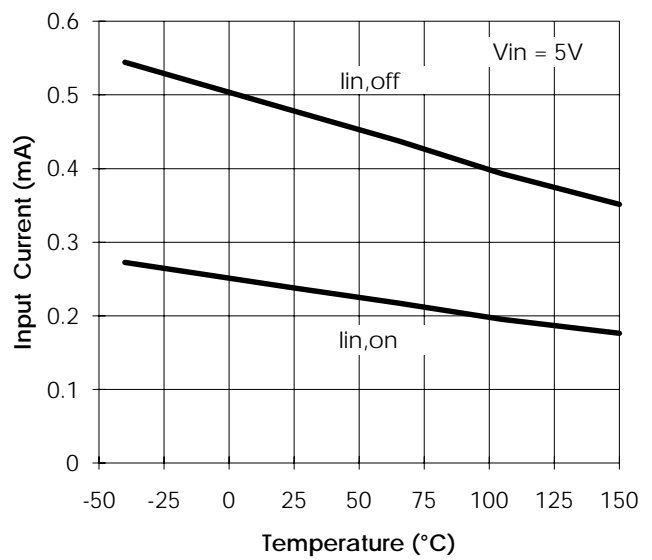

Figure 12 Input Current vs. Temperature



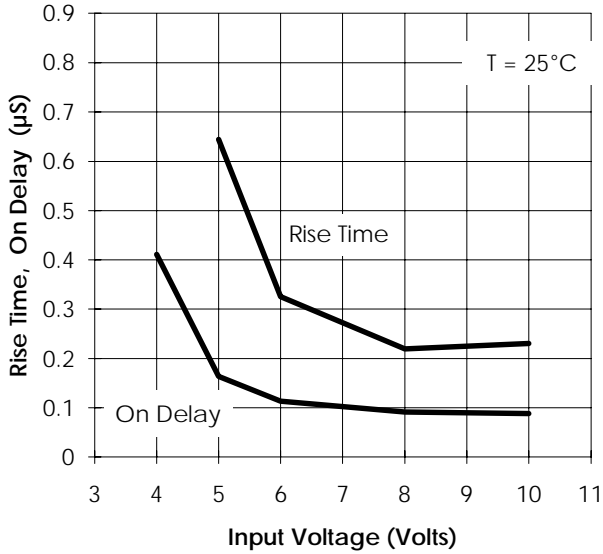

Figure 13 Turn-On Characteristics vs. Input Voltage

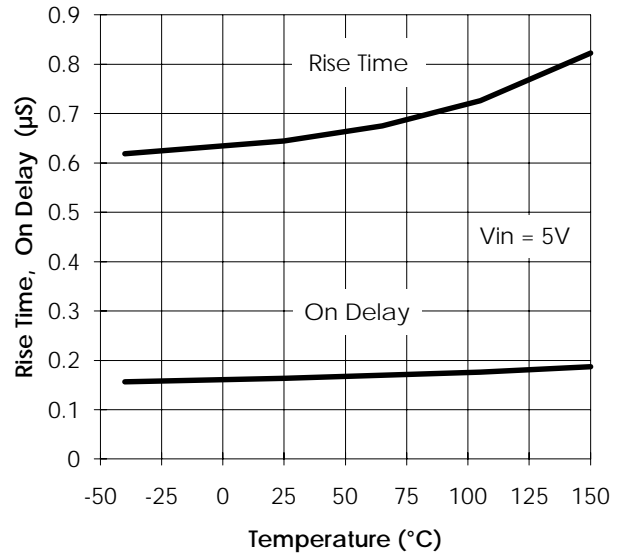

Figure 14 Turn-On Characteristics vs. Temperature

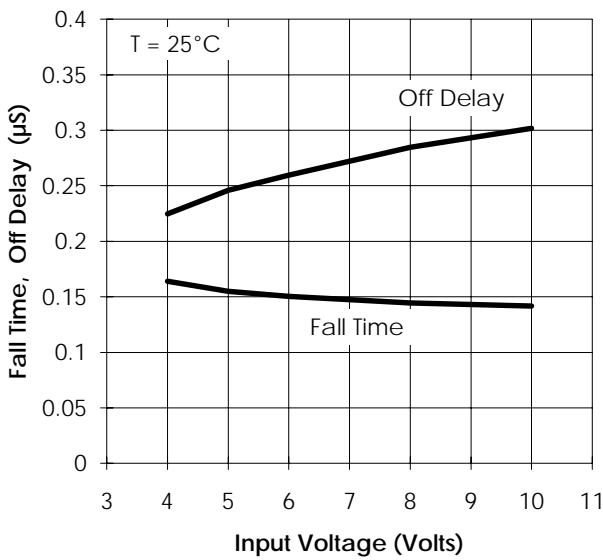

Figure 15 Turn-Off Characteristics vs. Input Voltage

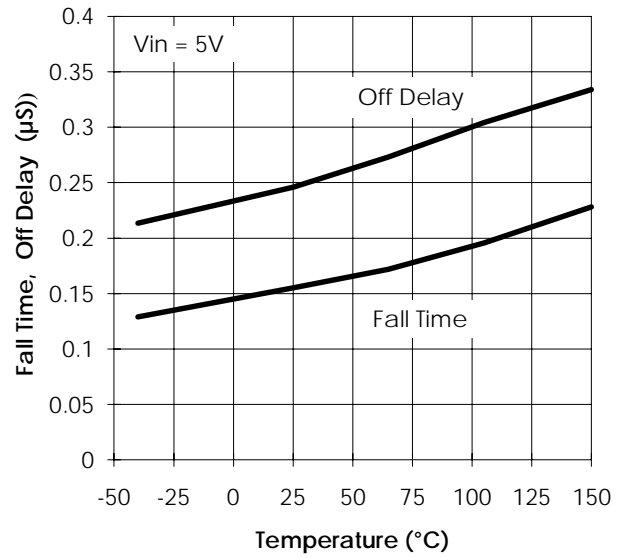

Figure 16 Turn-Off Characteristics vs. Temperature

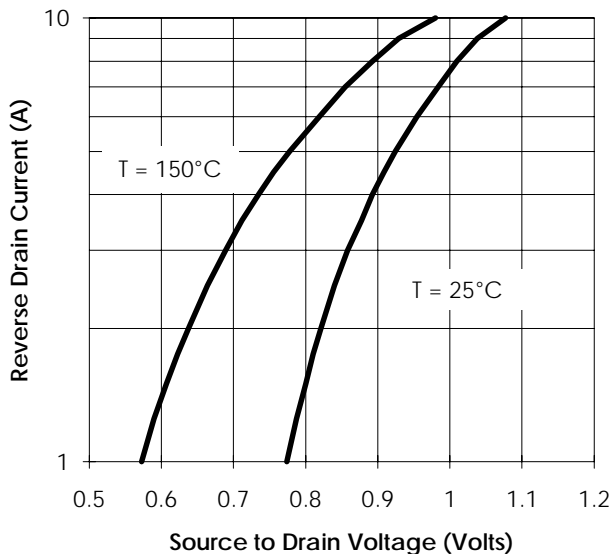

Figure 17 Source-Drain Diode Forward Voltage

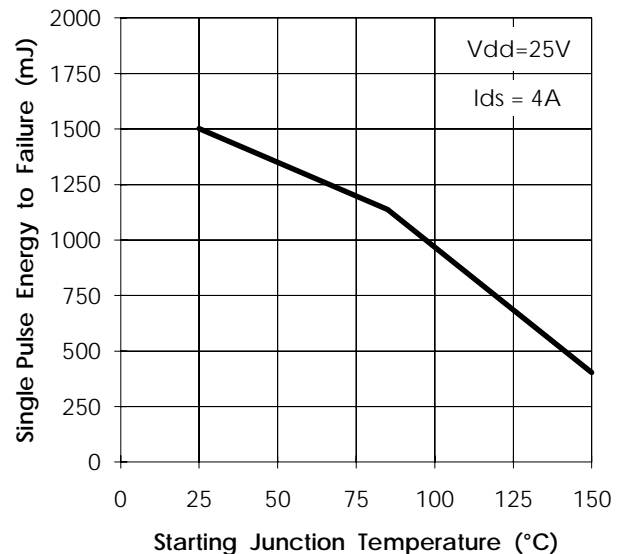

Figure 18 Unclamped Single Pulse Inductive Energy to Failure vs. Starting Junction Temperature

## Application Information

### Introduction

Protected monolithic POWER MOSFETs offer simple, cost effective solutions in applications where extreme operating conditions can occur. The margin between the operating conditions and the absolute maximum values can be narrowed, resulting in better utilization of the device and lower cost. ESD protection also reduces the off-circuit failures during handling and assembly.

### General Description

The IRSF3011 is a fully protected monolithic N-channel logic level POWER MOSFET with 200mW (max) on-resistance. The built-in protections include over-current, over-temperature, ESD and over-voltage.

The over-current and over-temperature protections make the IRSF3011 / IRSF3012 indestructible under any load conditions in switching or in linear applications. The built-in ESD protection minimizes the risk of ESD damage when the device is off-circuit. The IRSF3011 / IRSF3012 is fully characterized for avalanche operation and can be used for fast de-energization of inductive loads.

The TO-220 packaged IRSF3011 / IRSF3012 offers an easy upgrade with direct pin-to-pin replacement from non-protected devices.

### Block Diagram

As illustrated in figure A1, a zener diode between the input and the source provides the ESD protection for the input and also limits the voltage applied to the input to 10V.

The R-S flip-flop memorizes the occurrence of an error condition and controls the Q2 and Q3 switches. The flip-flop can be cleared by holding the input low for the specified minimum duration.

COMP1 and COMP2 comparators are used to compare the over-current and over-temperature signals with the built-in reference. Either comparator can reset the fault flip-flop and turn Q1 off. During fault condition, Q2 disconnects the gate of Q1 from the input, and Q3 shorts the gate and source of Q1, resulting in rapid turn-off of Q1. The zener diode between the gate and drain of Q1 turns Q1 on when the drain to source voltage exceeds 55V.

### Switching Characteristics

In the IRSF3011, the control logic and the protection circuits are powered from the input pin. When positive voltage appears at the input pin, the R-S flip-flop turns Q2 on and connects the gate of the main device to the input.

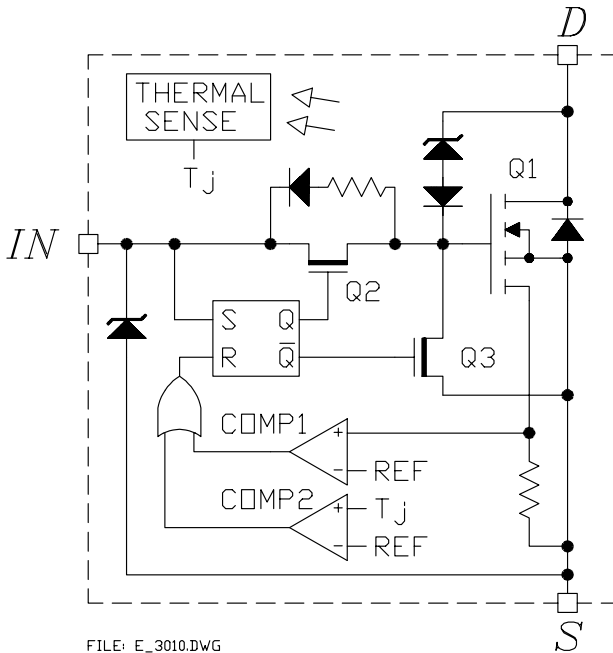

Figure A1. Block Diagram

The turn-on speed is limited by the channel resistance of Q2 and the gate charge requirements of Q1. The typical switching waveforms at 5V input voltage are shown in Figure A2. Using higher input voltage will improve the turn-on time but it will not affect the turn-off switching speed.

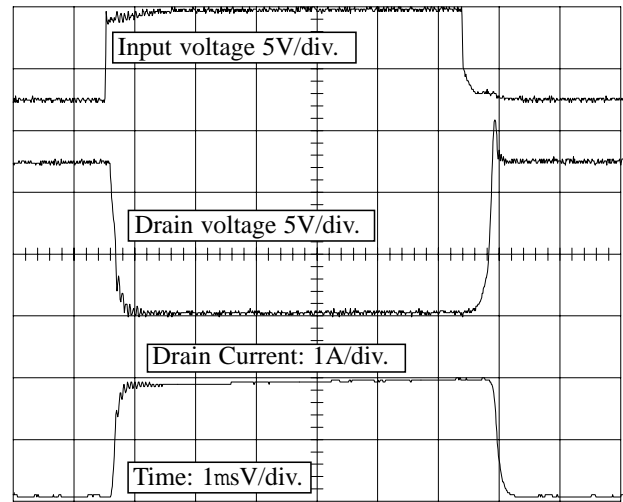

Figure A3. Switching waveforms with 7V Input voltage

The typical waveforms at 7V input voltage are shown in Figure A3. In typical switching applications (below 60kHz) the difference in switching losses between the IRSF3011 / IRSF3012 and the same size standard MOSFET is negligible.

### Over-Current Protection

When the drain current exceeds the preset limit, the protection circuit resets the internal flip-flop and turns Q1 off. Normal operation can be restored by holding the input voltage below the specified threshold level (approx. 1.3V) for the specified minimum  $t_{reset}$  time.

The typical waveforms at over-current shut-down are shown in Figure A4. After turn-on, the current in the inductor at the drain starts ramping up. At about 7A, the over-current protection shuts down the device.

### Over-Temperature Protection

Figure A5 illustrates the operation of the over-temperature protection. The IRSF3011 / IRSF3012 switches a 2W resistive load to a 10V power supply. When the thermal balance is established, the junction temperature is limited on a pulse-by-pulse basis.

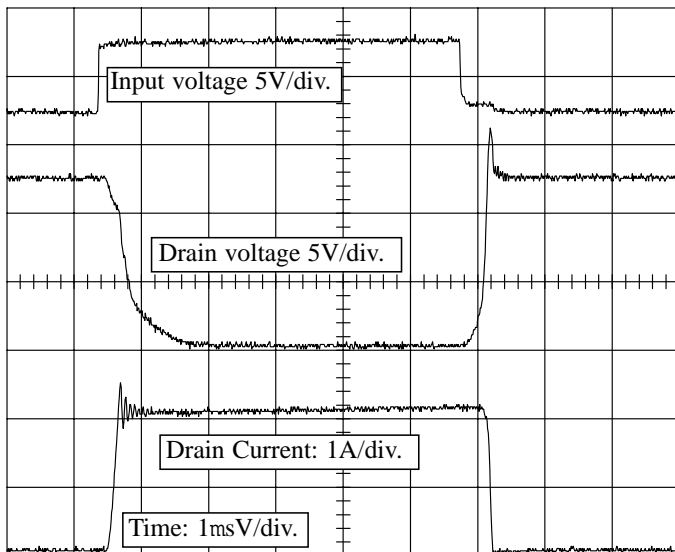

Figure A2. Waveforms switching clamped inductive load using 5V input voltage

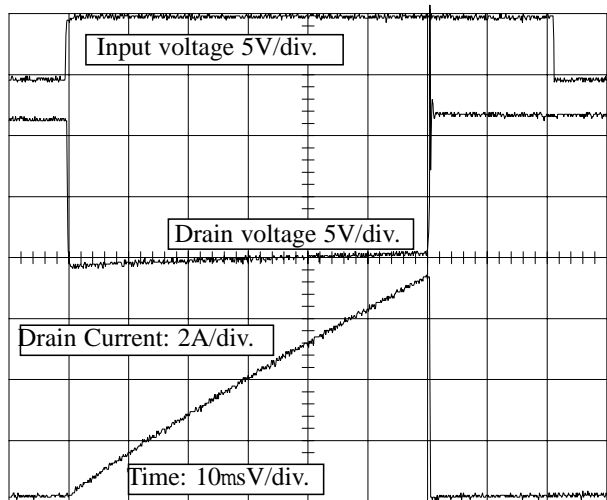

Figure A4. Waveforms at over-current shut-down

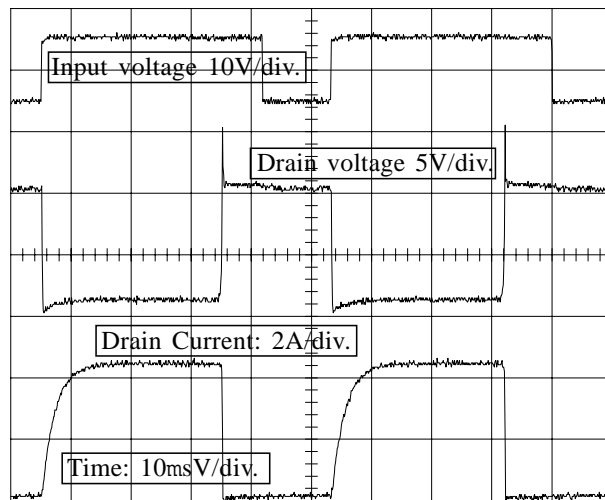

Figure A5. Over-temperature shut-down

## Over-Voltage Protection

When the drain-to-source voltage exceeds 55V, the zener diode between gate and drain turns the IRSF3011 / IRSF3012 on before the breakdown voltage of the drain-source diode is reached. This greatly enhances the energy the device can safely withstand during inductive load turn-offs compared to avalanche breakdown. Thus the device can be used for fast de-energization of inductive loads. The absorbed energy is limited only by the maximum junction temperature.

Note: For the most current drawings please refer to the IR website at:  
<http://www.irf.com/package/>